



HAL
open science

Severe serotonin depletion after conditional deletion of the vesicular monoamine transporter 2 gene in serotonin neurons: neural and behavioral consequences

Nicolas Narboux-Nême, Corinne Sagné, Stephane Doly, Silvina L Diaz, Cédric Bp Martin, Gaelle Angenard, Marie-Pascale Martres, Bruno Giros, Michel Hamon, Laurence Lanfumey, et al.

► To cite this version:

Nicolas Narboux-Nême, Corinne Sagné, Stephane Doly, Silvina L Diaz, Cédric Bp Martin, et al.. Severe serotonin depletion after conditional deletion of the vesicular monoamine transporter 2 gene in serotonin neurons: neural and behavioral consequences. *Neuropsychopharmacology*, 2011, 36, pp.2538-2550. 10.1038/npp.2011.142 . hal-00665880

HAL Id: hal-00665880

<https://hal.science/hal-00665880>

Submitted on 3 Feb 2012

HAL is a multi-disciplinary open access archive for the deposit and dissemination of scientific research documents, whether they are published or not. The documents may come from teaching and research institutions in France or abroad, or from public or private research centers.

L'archive ouverte pluridisciplinaire **HAL**, est destinée au dépôt et à la diffusion de documents scientifiques de niveau recherche, publiés ou non, émanant des établissements d'enseignement et de recherche français ou étrangers, des laboratoires publics ou privés.

Severe serotonin depletion after conditional deletion of the vesicular monoamine transporter 2 gene in serotonin neurons: neural and behavioral consequences

Abbreviated title: VMAT2 conditional deletion.

Nicolas Narboux-Nême^{1,2}, Corinne Sagné⁴, Stephane Doly^{1,2}, Silvina L. Diaz^{1,2}, Cédric B.P. Martin^{2,3}, Gaëlle Angenard^{1,2}, Marie-Pascale Martres^{2,5,6}, Bruno Giros^{2,5,6,7}, Michel Hamon^{2,3}, Laurence Lanfumey^{2,3}, Patricia Gaspar^{1,2}, Raymond Mongeau^{2,3}.

Author affiliation:

- 1- INSERM, UMR-S 839, Institut du Fer à Moulin, 17, rue du Fer à Moulin, 75005, Paris, France.
- 2- Université Pierre & Marie Curie, Paris 06, France.
- 3- INSERM, U894; 75013, Paris, France.
- 4- CNRS UMR8192-Université Paris Descartes, 75006, Paris, France.
- 5- INSERM, U952, 9 Quai St Bernard, 75005, Paris, France.
- 6- CNRS UMR 7224, 9 Quai St Bernard, 75005, Paris, France
- 7- Douglas Hospital, Department of Psychiatry, McGill University, Montreal, Canada

Corresponding author:

Patricia Gaspar,
INSERM U 839, 17 rue du Fer à Moulin, 75005, Paris, France
Tel : 331 45 87 61 11
Fax : 331 45 87 61 30
email : patricia.gaspar@inserm.fr

Manuscript information:

text pages: 19
figures: 7
Abstract: 230 words
Material and methods: 1624 words

Key words: Knockout mice, vesicular monoamine transporter, serotonin transporter, depression, anxiety, 5-HT_{1A} receptors, raphe, antidepressant drugs, defense behaviors.

Abbreviations: VMAT vesicular monoamine transporter protein; *Vmat2*: Vesicular monoamine transporter 2 gene; 5-HT: serotonin; SERT: serotonin transporter; MAOI: monoamine oxidase inhibitor; TPH2, tryptophan hydroxylase 2.

Abstract.

The vesicular monoamine transporter type 2 gene (VMAT2) plays a crucial role in the storage and synaptic release of all monoamines, including serotonin (5-HT). To evaluate the specific role of VMAT2 in 5-HT neurons, we produced a conditional ablation of VMAT2 under the control of the serotonin transporter (*slc6a4*) promoter. VMAT2^{sert-cre} mice showed a major (-95%) depletion of 5-HT levels in the brain with no major alterations of the other monoamines. Raphe neurons contained no 5-HT immunoreactivity in VMAT2^{sert-cre} mice but developed normal innervations, as assessed by both tryptophan hydroxylase 2 and 5-HT transporter labeling. Increased 5-HT_{1A} autoreceptor coupling to G protein, as assessed with agonist stimulated [³⁵S]GTP- γ -S binding, was observed in the raphe area, indicating an adaptive change to the reduced 5-HT transmission. Behavioral evaluation in adult VMAT2^{sert-cre} mice showed an increase of escape-like reactions in response to tail suspension, and anxiolytic-like response in the novelty suppressed feeding test. In an aversive ultrasound-induced defense paradigm, VMAT2^{sert-cre} mice displayed a major increase of escape-like behaviors. Wild-type-like defense phenotype could be rescued by replenishing intracellular 5-HT stores with chronic pargyline (a monoamine oxidase inhibitor) treatment. Pargyline also allowed some form of 5-HT release, albeit in reduced amount, in synaptosomes from VMAT2^{sert-cre} mice brain. These findings are coherent with the notion that 5-HT plays an important role in anxiety, and provide new insights on the role of endogenous 5-HT in defense behaviors.

Introduction

Serotonin (5-HT) has a central importance in the control of mood and anxiety states (Lucki 1998). Dysfunctions of 5-HT neurotransmission can result from alterations at several critical points of monoamine metabolism such as synthesis, release, reuptake, catabolism, or serotonin receptors (Morilak and Frazer 2004). All these constitute entry points to pharmacological therapeutic approaches (Berton and Nestler 2006) and to genetic variations that impact disease predisposition. Vesicular monoamine transporters (VMAT) appear as important targets in regard to the neurobiology of mood. Indeed, the initial formulation of the monoamine theory of depression was derived from studies with reserpine, an irreversible VMAT blocker, prescribed as an antihypertensive agent, subsequently found to cause depression in humans (Freis 1954). Moreover, there is evidence for a link of depression with genetic polymorphism of the *Vmat2* gene (Christiansen, et al. 2007; Gutierrez, et al. 2007). The main function of VMAT is to concentrate biogenic amines into intracellular storage organelles such as synaptic vesicles, shielding them from degradation, and concentrating them for release into the synaptic cleft (Henry, et al. 1998). Nevertheless, 5-HT can also function as a paracrine transmitter by acting on receptors distant from synaptic release sites (Bunin and Wightman 1999), and non-vesicular release of neurotransmitters is known to occur in some physiological conditions (Attwell, et al. 1993; Wu, et al. 2007).

VMATs exist as two different isoforms: VMAT1 mainly expressed in chromaffin and enterochromaffin cells, and VMAT2 essentially expressed in monoaminergic neurons (Erickson, et al. 1996; Erickson and Eiden 1993). Microdialysis (Adell and Artigas 1998) and voltametry (Bunin, et al. 1998; O'Connor and Kruk 1991) experiments showed that tetrabenazine, a selective VMAT2 blocker, prevents the release of 5-HT in the raphe and in axon terminal fields while *Vmat2*-KO mice showed no release of amines (Fon, et al. 1997; Wang, et al. 1997). *Vmat2*-KO mice do not survive beyond the first postnatal days (Alvarez, et al. 2002; Fon, et al. 1997; Wang, et al. 1997) preventing the long-term evaluation of the consequences of a lack of monoamine/5-HT release. VMAT2 heterozygous mice with rather small (20-30%) reductions in brain amines showed no change in anxiety-like behaviors, but indications of a “depression-like” phenotype (Fukui, et al. 2007). However, it was unclear whether this phenotype was linked to a reduced release of 5-HT or of other amines (DA, NA, histamine) that also depend on VMAT2 for vesicular storage.

To overcome this limitation, we generated a conditional deletion of VMAT2 that allowed investigating the role of this transporter specifically in 5-HT neurons. Specific ablation of VMAT2 in raphe 5-HT neurons was obtained by Cre recombinase expressed under the control of the 5-HT transporter gene (SERT, slc6a4) promoter. We report that VMAT2^{SERT-cre} mice have a near complete depletion of 5-HT in the brain, consequent to abolished vesicular 5-HT uptake. Raphe neurons develop normally and show a normal innervation of target areas. A consequence of the sustained 5-HT depletion was to increase the coupling of 5-HT_{1A} autoreceptors with its G protein, a known sensitive index of chronic changes in 5-HT levels. Behavioral observations in adults indicated that abolished synaptic 5-HT release caused anxiolytic-like phenotype, while increasing reactivity to innately aversive stimuli. The latter alteration was reversed by a 3-week treatment with pargyline, a monoamine oxidase inhibitor (MAOI), which markedly increased brain 5-HT levels. These observations are coherent with the notion that elevated levels of endogenous 5-HT in stressful situations can inhibit prepotent behaviors and is linked with anxiety (Gray and McNaughton 2000). This study established VMAT2^{SERT-cre} mice as a powerful model to analyze the role of 5-HT in otherwise normally developed raphe neurons.

Materials and methods

Animals

Procedures involving animals and their care were conducted in accordance with directives of the European Community (Council directive 86/609) and the French Agriculture and Forestry Ministry (Council directive 87-848, October 19, 1987, permissions 75-977 to L.L. and 00782 to P.G).

The floxed *Vmat2* mouse line was produced at the Mouse Clinical Institute (Institut Clinique de la Souris, MCI/ICS, Illkirch, France) in coordination with unit Inserm U952 (Bruno Giros, to whom correspondence concerning the mouse line should be addressed: bruno.giros@inserm.fr). A 9 kb fragment of the *Vmat2* gene encompassing exons 1-3 was subcloned into the targeting vector and the two *loxP* sites and the neomycin-selectable cassette flanked by two *FRT* sites were introduced in the introns flanking the first coding exon. Embryonic stem cells were electroporated with the targeting vector and cell clones resistant to selection were screened by PCR and Southern analysis to identify clones that resulted from a correct targeting event (2 /744 clones analyzed). Excision of the neomycin cassette was performed *in vivo* by crossing chimeric mice with transgenic mice expressing the Flp recombinase under the control of the early beta-actin promoter. The presence of the floxed allele in the progeny was screened by PCR. VMAT2^{lox/lox} mice were maintained on a C57BL/6J background.

The SERT^{cre} mouse line has previously been described (Zhuang, et al. 2005). This is a gene trap construction, which replaces exon 14 of the serotonin transporter gene (*sert*) with a gene sequence encoding cre-recombinase. Previous studies showed that recombination occurs by E12 in the raphe neurons (Narboux-Neme, et al. 2008) and that virtually all TPH2 neurons in the raphe have recombined in postnatal life (Zhuang, et al. 2005). Male VMAT2^{lox/+}/SERT^{cre/+} or VMAT2^{lox/lox}/SERT^{cre/+} mice were mated with female VMAT2^{lox/lox} to generate the 3 genotypes that were analyzed: VMAT2^{lox/lox}/SERT^{cre/+} (recombined); VMAT2^{lox/lox} (control 1); VMAT2^{lox/+}/SERT^{cre/+} (control 2). After weaning and sexing, males and females were housed separately in groups of 6-8 animals per cage and maintained under standard laboratory conditions (22 ± 1°C, 60% relative humidity, 12-12 hours light-dark cycle, food and water ad libitum). Male mice were used at 2-3 months of age when their body weight in each genotype equally ranged between 20 and 25 g (Narboux-Nême, et al. 2009).

Some histological assays (VMAT and 5-HT immunohistochemistry) were performed on P7 mice for early detection of the phenotype, which was found the same at adult ages. In addition, some C57BL/6J mice (purchased from Janvier, France) were used for pharmacological studies.

Neurotransmission studies

Tissue levels of 5-HT, 5-hydroxyindolacetic acid (5-HIAA), noradrenaline (NA) and dopamine (DA) were determined using high pressure liquid chromatography with electrochemical detection (HPLC-ED) as previously described (Mongeau, et al. 2010). Crude synaptosomes from VMAT2^{sert-cre} and control mice, prepared as previously described (Gray and Whittaker 1962), were used in experiments for the measurements of [³H]5-HT uptake and release induced with the releasing agent 3,4-methylenedioxymethamphetamine (MDMA: 0.1 nM - 10 μM) or potassium (3 - 100 mM). Quantitative autoradiography of 5-HT_{1A} receptor-mediated [³⁵S]GTP-γ-S binding using the non-selective agonist 5-carboxamido-tryptamine (5-CT; 10-1000 nM; non-specific binding defined by WAY 100635) was done as previously described (Fabre, et al. 2000). See the supplementary online information for further details.

Histological analyses

Mice were perfused transcardiacally with 4% paraformaldehyde, and brains were postfixed overnight in 4% paraformaldehyde, cryoprotected in 30% sucrose and serially sectioned (60 μm thick sections) on a freezing microtome. Alternate series for immunohistochemistry, *in situ* hybridization and counterstaining were used. Immunohistochemistry was performed using specific antibodies against VMAT2 (1:10000, Phoenix), 5-HT (1:50000, Sigma), SERT (1:1000, Calbiochem) as described previously (Alvarez, et al. 2002). Secondary antibodies used were biotinylated anti-rabbit IgG (1:300, Jackson Laboratories) followed by avidin-biotin-peroxidase complex (1:400, Amersham). Peroxidase activity was detected with 3,3'-diaminobenzidine peroxide (DAB/H₂O₂). *In situ* hybridization experiments were performed as previously described (Bally-Cuif and Wassef 1994). The TPH2 c-DNA plasmid previously described (Cote, et al. 2003) was donated by P. Ravassard (CRICM, UPMC, Paris).

Images were captured with a Cool Snap FX camera fitted to a Leica DM RD microscope under consistent light conditions using 20x/0.70 objectives. Images were copied

to 8-bit RGB digital format and analyzed with ImageJ software. The density of SERT-immunoreactive fibers was estimated by counting the number of intersecting fibers with a grid composed of hemicycloids, as previously described (Gaspar, et al. 1991). The density of TPH2 labeled neurons was estimated in two sections through the rostral portion of the dorsal raphe nucleus. All neurons contained in a grid of 250x250 um were counted. The grid was placed over 3 different areas of the dorsal raphe, for each case.

Behavioral testing

Experiments were carried out in adult (2-4 months) VMAT2^{sert-cre} and controls from the same litters that included both VMAT2^{lox/lox} and VMAT2^{lox/+} SERT^{cre/+} male mice.

Elevated plus maze (EPM)

The maze was made of polyvinylchloride with two lit open arms (27×5 cm) and two opaque closed arms (27×5×15 cm). The arms radiated from a central platform (5×5 cm) and the apparatus was 38.5 cm above the floor. To initiate the 5-min test session, the mouse was placed on the central platform, facing an open arm. The mouse was considered to be on the central platform whenever two paws were on it, and in one of the arms when all four paws were inside. Behavioral analysis was done using a video recording using ODlog (Macropod Software) by an observer unaware of genotype. Results are reported as the time spent and the number of entries in the open arms to assess anxiety-like behavior, and total number of entries into both open and closed arms to assess locomotor activity.

Spontaneous locomotor activity

Locomotor activity was measured using a computer-based photobeam apparatus (Actisystem II, Panlab, Barcelona, Spain). Actimeter box (area: 300 x 150 mm; height 180 mm; with plexiglass wall and grid floor) detected mouse movements by means of two infrared light beams. Mice were placed in the testing room at least 2 hours before the experiment.

Novelty suppressed feeding (NSF)

Animals were placed one per cage for at least one week, and their bedding was changed just before food deprivation. All mice were deprived of their regular food for 48 hours and placed in the testing room for at least 1 hour before the test. They were then placed into an unfamiliar arena (area: 400 x 400 mm; height 180 mm; containing bedding) with a small plate containing food at the center of the field. The latency to feed was measured using a video recording, from the time the mouse is placed in the periphery of the arena until the animal began feeding. The latency to feed was also measured in the home cage, to assess if changes in latency might be accounted for by alteration in the feeding drive rather than reaction to the anxiogenic environment. The delay was measured from the time the mouse was placed at the periphery of the cage containing the food in the center.

Food consumption

Animals were placed one per cage for one week before measuring daily food intake over one week. The pellets consumed were measured by weighing the amount of remaining food each day.

Tail suspension test

The apparatus consists of three suspension units divided by walls (ID-Tech-Bioseb, Chaville, France). Mice were suspended by the tail, using an adhesive tape attached to a strain gauge transducing movements into a signal transmitted to a central unit for signal digitalization. Although VMAT2^{ser-cre} mouse weights differ from controls during postnatal life (Narboux-Nême, et al. 2009), weight differences were no longer observed at adult age which eliminates any bias in measurements with this test. The duration of immobility was measured automatically by the software over a 6-min period. Struggling duration was analyzed from the traces generated by the software, and was defined as the total time the mouse spent in activity burst (i.e. excluding all the small movements), during the 6 min test period. Activity burst was defined as a force exerted on the transducer greater than or equal to 3 g above the baseline value for more than 2 s.

Ultrasound-induced defense reactions

Mice were tested for their innate fear reactions to a train of ultrasonic stimuli (US), as previously described (Mongeau, et al. 2003). Animals were placed one per cage for at least one week before testing. In brief, 100 ms frequency sweeps between 17-20 kHz, 85 dB, alternately ON 2 s and then OFF 2 s for 1 min were delivered into the home cage (18 x 29 cm) after a 3 min baseline period. Flight reactions triggered during the ON periods were measured as the number of running events from one side of the cage to the other followed by behavioral arrest, while the percentage time freezing to the US was quantified by sampling events of complete immobility (except respiration) every 4 s during the OFF period. These defense behaviors were measured from a video file by an observer unaware of mouse genotype.

Pargyline treatment

Mice were treated using subcutaneous osmotic minipumps (Alzet model 2004) to avoid injection handling which alters mice spontaneous defense behaviors to the US. Chronic pargyline treatment was done to achieve sustained MAOA and MAOB inhibition and optimally enhanced 5-HT neurotransmission in both control and VMAT2^{sert-cre} mice. Pargyline (70 mg/kg x day; Fluka, Buchs, Zwitterland) or vehicle (water) was administered for 3 weeks using minipumps inserted in sterile conditions on the back of the animals under pentobarbital anesthesia (55 mg/kg, i.p.).

Statistics

Data were analyzed using the Student's t-test when comparing two groups. The [³⁵S]GTP- γ -S binding data and the effects of pargyline treatment on 5-HT levels and flight behaviors in relation to the genotype were analyzed using the two-way Anova followed by Bonferonni's post-hoc test. EC₅₀ values were compared by a one-way Anova followed by Bonferonni's test. Statistical significance was set at P < 0.05.

Results

Specific invalidation of the *Vmat2* gene in 5-HT neurons

Conditional ablation of *Vmat2* was obtained by inserting *loxP* sequences into the genomic sequence of the *Vmat2* gene by homologous recombination, which produced the new mouse line VMAT2^{lox/lox} (Fig. 1). These mice were crossed to a previously described mouse line in which the 5-HT transporter (SERT, Slc6a4) promoter drives the expression of bacterial *Cre* recombinase (Narboux-Neme, et al. 2008; Zhuang, et al. 2005). The VMAT2^{lox/lox}/SERT^{cre/+} double transgenic line (hence termed VMAT2^{sert-cre}) was amplified for analysis. As with other 5-HT depleted transgenic mice (Alenina, et al. 2009; Dai, et al. 2008), there was an increased mortality of VMAT2^{sert-cre} mice between P1 and P30 compared to control mice.

We first checked the effectiveness and selectivity of the Cre-mediated excision using an antiserum that specifically stains the VMAT2 isoform. In wild type (C57BL/6J) mice and VMAT2^{lox/lox} mice, immunolabeling was observed in neurons of the raphe, the locus coeruleus, the substantia nigra, and the hypothalamus (Fig. 2A). In the VMAT2^{sert-cre} mice (Fig. 2A), VMAT2-immunostaining was abolished in the raphe neurons but was still present in noradrenergic neurons of the locus coeruleus, in dopaminergic neurons of the substantia nigra. Similarly VMAT2-immunostaining was unchanged in the hypothalamus and histamine neurons (Fig. 2A). No visible reduction in VMAT2-immunostaining was detected in heterozygote mice lacking only one allele of the VMAT2 gene (VMAT2^{lox/+}/SERT^{cre/+}; data not shown).

5-HT immunocytochemistry showed a major and uniform depletion of 5-HT immunostaining in all axon terminal fields (fig. 2B) with very faint residual staining in raphe neurons in the brainstem in P7 mice (Fig. 2B) and a complete lack of labeling in the adult raphe. However, the density of TPH2-positive neurons, in the rostral part of the dorsal raphe nucleus, was unchanged (Fig. 2C). To assess raphe projections, immunolabeling was performed with anti-SERT antibodies. Examination of serial coronal sections through the brain showed a comparable distribution and morphology of the SERT-labeled axons in VMAT2^{sert-cre} and control brains. The density of SERT-labeled axons was estimated in the cerebral cortex and hippocampus. This showed no difference in fiber density between control and mutants (Fig. 2C). Overall these results indicated that 5-HT raphe neurons developed normally in VMAT2^{sert-cre} mutants compared to WT mice.

Consequences on monoamines metabolism, uptake and signal transduction

Tissue monoamines' levels were measured by HPLC in various brain areas (cortex, striatum, hippocampus, brainstem), gut, and blood, as these tissues are known to produce or contain large amounts of 5-HT. Monoamines levels were not significantly different in wild-type (C57BL/6J), VMAT2^{lox/lox}, and VMAT2^{lox/+}/SERT^{cre/+} mice, that lack one allele of VMAT2 (results not shown), hence, in subsequent studies the VMAT2^{lox/lox} and the VMAT2^{lox/+}/SERT^{cre/+} mice were pooled as controls. Dramatic decreases in 5-HT levels were observed throughout the brain of VMAT2^{sert-cre} mice (from -92% to -96%), with no significant differences between brain structures (Fig. 3A, left). Remarkably, no changes in 5-HIAA levels were observed (Fig. 3A, right). This suggests (with data of Fig. 2C) that 5-HT was produced in normal amounts. Dopamine levels in the striatum and noradrenaline levels in the hippocampus and the cortex (Fig 3) were not or only marginally altered, although there was a $17 \pm 3 \%$ ($P < 0.01$) decrease of hippocampal NA in VMAT2^{sert-cre} mice [that could be explained by a lack of stimulatory action of 5-HT on NA terminals in that area (Mongeau, et al. 1994)] as compared to controls (fig. 3B). By contrast, 5-HT levels were normal in the gut (Fig. 3C), consistent with the fact that enterochromaffin cells express VMAT1 rather than VMAT2 (Erickson, et al. 1996). A different situation occurred in the blood where a $80 \pm 3 \%$ ($P < 0.001$) decrease of 5-HT levels was noted (Fig. 3C), consistent with the notion that platelets use VMAT2 rather than VMAT1 to store 5-HT (Holtje, et al. 2003).

The release of endogenous 5-HT was examined in synaptosomes preparations obtained from the whole brain. No potassium-induced release of 5-HT was observed in untreated synaptosomes from VMAT2^{sert-cre} mice (Fig. 4A). [³H]5-HT uptake and MDMA- and potassium-induced release were also analyzed on synaptosomes from control, SERT^{cre/+} and VMAT2^{sert-cre} mice (Fig. 4 B-D). After loading, [³H]5-HT is normally distributed between two compartments, a fraction in the storage vesicles and another fraction in the axoplasm. The MAOI pargyline (0.1 mM) was added to the medium to prevent degradation of [³H]5-HT occurring in the axoplasm.

In VMAT2^{sert-cre} synaptosomes, uptake of [³H]5-HT was reduced to a similar level as that observed in reserpine (0.1 μ M) - treated synaptosomes from WT mice (Fig. 4B). In contrast, no significant alterations were noted in the SERT^{cre/+} synaptosomes. MDMA-induced release, occurring through the reversal of the reuptake carrier (Hekmatpanah and Peroutka 1990; McKenna, et al. 1991; Renoir, et al. 2008), was analysed in synaptosomes from WT

and VMAT2^{sert-cre} mice (Fig. 4C). The total amount of [³H]-5-HT in synaptosomes was decreased in VMAT2^{sert-cre} or WT mice treated with reserpine compared to controls (WT = 0.13 ± 0.01; SERT^{cre/+} = 0.14 ± 0.02; VMAT2^{sert-cre} = 0.07 ± 0.01; WT + reserpine = 0.06 ± 0.01 mmol/g of protein), as expected from the reduced uptake of [³H]5-HT into the storage vesicles of VMAT2^{sert-cre} mice compared to WT mice (Fig. 4B). There was a small but significant change in the concentration of MDMA that triggers 50% release in VMAT2^{sert-cre} mice compared to control mice (Fig. 4C): the dose response curve was slightly shifted to the left when using VMAT2^{sert-cre} synaptosomes (log EC₅₀: VMAT2^{sert-cre} = -7.35 ± 0.11; WT = -6.86 ± 0.09 M, n=3, P < 0.01). A similar change compared to WT synaptosomes was found in WT synaptosomes treated with reserpine (log EC₅₀: WT + reserpine = -7.26 ± 0.11 M, P < 0.05), but not in synaptosomes from SERT^{+/cre} mice (log EC₅₀: -6.69 M ± 0.14; Fig. 4C). However, the concentration of KCl necessary to trigger 50% of maximal release of [³H]5-HT was similar across all synaptosomes preparations (Fig. 4D; EC₅₀: WT = 24.7 ± 8.5 mM; VMAT2^{sert-cre} = 21.8 ± 5.4 mM; SERT^{cre/+} = 23.9 ± 4.8 mM; WT + reserpine = 25.9 ± 8.5 mM). This release is likely to represent a predominantly axoplasmic pool of [³H]5-HT since all experiments were conducted in presence of pargyline.

Potassium-induced release is only weakly dependent on the presence of calcium in the media in the above conditions (varying from 0 to 30% at 3-100 mM of KCl; not shown), suggestive of non-vesicular release. Other experimental conditions were used to test calcium-dependent release. This involved the retrieval of pargyline from the media and shorter potassium pulses (30 s). In these conditions we observed a calcium dependent release of [³H]5-HT (indicated in figure 4E as a decrement in the amount of radioactivity in the synaptosomes after KCl stimulation) in WT mice, whereas no significant calcium dependent vesicular release was found in synaptosomes from VMAT2^{sert-cre} mice.

To assess whether adaptive changes occur at 5-HT receptors as a consequence of the VMAT2^{sert-cre} 5-HT depletion, we measured 5-HT_{1A} receptor-stimulated [³⁵S]GTP-γ-S binding using 5-carboxamido-tryptamine (5-CT) as the agonist (Fabre, et al. 2000). [³⁵S]GTP-γ-S binding was significantly increased in the dorsal raphe nucleus in response to 5-HT_{1A} receptor activation by 5-CT in the VMAT2^{sert-cre} compared to control mice (P < 0.0001, two way Anova, Fig. 5A), suggesting an upregulation of the 5-HT_{1A} autoreceptors and / or enhanced coupling efficacy of these autoreceptors to G proteins. In contrast, no change in the

5-CT-induced [³⁵S]GTP-γ-S binding was found in post-synaptic sites, such as the dorsal hippocampus (Fig. 5B), the ventral hippocampus and the septum (not shown).

Behavioral consequences

We measured the consequences of VMAT2^{sert-cre}-induced 5-HT depletion in standard models of anxiety and depression. In the elevated plus-maze (EPM), VMAT2^{sert-cre} mice spent the same amount of time exploring the open arms as control mice (Fig. 6A). There was however a significant decrease ($-37 \pm 7\%$; $P < 0.05$) in the overall entries into both the closed and the open arms (Fig. 6A) suggesting a change in locomotor activity that could confound the interpretation of the EPM data. Indeed, specific assessment of locomotion with an actimeter also showed a 40% reduction in spontaneous locomotor activity of the VMAT2^{sert-cre} mice (Fig. 6B).

To further explore the anxiety-related phenotype in a model less dependent on locomotion, we applied the novelty suppressed feeding test, in which there is a conflict between the feeding drive and risk assessment behaviors. VMAT2^{sert-cre} mice initiated to feed much sooner (about 3 times faster; Fig. 6C) than control mice in the unfamiliar cage but not in the home cage, indicating an anxiolytic-like phenotype, rather than a change in appetite. Furthermore, in isolated adult mice of the same weight (22 ± 1 g), food consumption measured during one week did not differ between transgenic and control mice (VMAT2^{sert-cre}: 3.58 ± 0.28 g; control: 3.65 ± 0.30 g; mean \pm S.E.M. n=5-6). Finally, when tested in the tail suspension test (TST), VMAT2^{sert-cre} mice were more reactive than control mice. Indeed, immobility time was reduced (Fig. 6D; $-37 \pm 12\%$; $P < 0.01$) and time spent actively struggling to escape was increased ($+68\% \pm 13\%$, $P = 0.001$). These observations suggested an increase of active defense behaviors of VMAT2^{sert-cre} mice in the TST.

Interestingly, VMAT2^{sert-cre} mice also displayed a large increase of behavioral reactivity in response to stimulation with the innately aversive ultrasonic stimulus (US; $P < 0.01$; fig. 7A). In addition, VMAT2^{sert-cre} mice froze less in reaction to the US compared to control mice (control: $69 \pm 7\%$ of time during the OFF periods; VMAT2^{sert-cre}: $37 \pm 8\%$; mean \pm S.E.M.; $P < 0.05$, n=4-5, not shown).

To examine whether the change in behavioral reactivity to the US in VMAT2^{sert-cre} mice was due to the reduced 5-HT levels, we investigated the effects of a long term pargyline

treatment (70 mg/kg x day, for 3 weeks). Pargyline reversed the 5-HT depletion ($-94 \pm 0.01\%$) observed in VMAT2^{sert-cre} mice, and even markedly increased 5-HT levels compared to vehicle treated control mice (Fig. 7D). Nevertheless, after pargyline treatment 5-HT tissue levels was still $20 \pm 13\%$ lower in VMAT2^{sert-cre} mutants compared to pargyline-treated control mice (Fig. 7D). Two-way Anova indicated a significant effect ($P < 0.0001$) of treatment $F(1,19) = 574$ and of genotype $F(1,19) = 46$, but no significant interactions [$F(1,19) = 0.3$]. Pargyline also restored some 5-HT immunostaining in raphe neurons and axon terminals of VMAT2^{sert-cre} mice (Fig. 7B,C), although the levels were lower than those observed in controls (not shown). In response to the US, VMAT2^{sert-cre} mice treated with pargyline no longer displayed their increment of flight responses compared to control mice (Fig. 7A). Two-way Anova indicated significant effects ($P = 0.01$) of treatment $F(1,12) = 9$, genotype $F(1,12) = 9$ and a significant treatment x genotype interaction $F(1,12) = 10$. Furthermore, there were no changes in the percentage of time spent freezing in response to the US in pargyline treated mice (control: $87 \pm 6\%$ of time during the OFF periods; VMAT2^{sert-cre}: $76 \pm 24\%$, not shown).

Discussion

Previous studies have shown that the majority of brain monoamines resides in the vesicular storage pools and that pharmacological inhibition of VMAT prevents vesicular release of 5-HT (Adell and Artigas 1998; Bunin, et al. 1998; O'Connor and Kruk 1991). We confirm here that VMAT2 is the only vesicular transporter implicated in this effect in the CNS, since its genetic ablation in 5-HT neurons entirely reproduced the effects on 5-HT uptake of complete VMAT inhibition with reserpine. Interestingly, however, in the VMAT2^{sert-cre} mice, 5-HT is probably produced at normal rates, as suggested by (i) the normal levels of *TPH2* gene expression, (ii) the normal amounts of 5-HIAA (the product of oxidative deamination of 5-HT), and (iii) the normal raise of 5-HT levels after MAO inhibition by pargyline. Hence, all 5-HT produced or taken up by neurons, that cannot be stored into vesicles is rapidly metabolized by mitochondrial monoamine oxidases present in raphe neurons (Shih, et al. 1997; Vitalis, et al. 2002). Because 5-HT continues to be produced in raphe neurons at a seemingly normal rate, it can still be released. While such release is likely to be marginal in standard conditions because of the low endogenous levels of 5-HT, it could still occur following administration of a MAOI which causes a major raise of 5-HT tissue levels.

Furthermore, it cannot be excluded that pargyline could enhance some form of vesicular storage (Buu 1989). In VMAT2^{sert-cre} mice MAOIs restored some functions such as the inhibitory action of 5-HT on active defense reactions (fig. 7B) as well as normal growth (Alvarez, et al. 2002; Narboux-Nême, et al. 2009). This functional restoration *in vivo* fits well with the potassium- and MDMA-induced releases of [³H]5-HT observed *in vitro* in VMAT2^{sert-cre} synaptosomes.

The mechanism involved in the [³H]5-HT release in VMAT2^{sert-cre} synaptosomes is presently unclear, but two non-mutually exclusive possibilities can be discussed: 1) Release of [³H]5-HT via the carrier (Evans and Collard 1988). Although this was suggested to occur in VMAT2 KO mice (Fon, et al. 1997), we do not presently have any data in favor of flux reversal in VMAT2^{sert-cre} mice. 2) Alternate vesicular storage and release pathways. It is known that 5-HT can passively cross the membrane of intracellular acidic organelles where it is protonated and remains trapped because charged monoamines cannot cross back membranes. In view of pH differences between vesicles and axoplasm, there could be at least a 100-fold increase in [³H]5-HT vesicular concentration compared to the axoplasm (Njus, et al. 1986), although this passively generated gradient remains very small compared to that generated by VMAT2, it may nevertheless be a way to compensate for VMAT2 loss. Future studies are clearly needed to understand how 5-HT release can occur in the VMAT2^{sert-cre} mice.

Beyond the cellular mechanisms involved, an important finding here is that [³H]5-HT stabilized via MAO inhibition in the axoplasm can be mobilized out of the synaptosomes. The small but significant changes in the EC₅₀ values obtained after MDMA stimulation indicate that the process underlying 5-HT release in VMAT2^{sert-cre} mice is likely to be different from that of WT mice. However, the relatively low calcium dependency of our release conditions in presence of pargyline might preclude similar observation after potassium stimulation. It is also important to emphasize that in the absence of pargyline, calcium-dependent vesicular release of 5-HT was not observed in VMAT2^{sert-cre} mice.

The reduced 5-HT in the VMAT2^{sert-cre} mice caused a sensitization of the 5-HT_{1A} autoreceptors coupled to G_{ai} proteins in the dorsal raphe nucleus. In contrast, the decrease in 5-HT contents in the VMAT2^{sert-cre} mice caused no adaptive changes of 5-HT_{1A} receptors in target areas, such as the hippocampus. This is in line with the notion that raphe 5-HT_{1A} autoreceptors, but not hippocampal 5-HT_{1A} receptors, show modulation in response to

changes in 5-HT levels (Fabre, et al. 2000; Mannoury la Cour, et al. 2006; Mongeau, et al. 1997) and indicate that extracellular 5-HT level was much reduced at the level of serotonergic somas.

The VMAT2^{sert-cre} mouse line offers an interesting model of hyposerotonergia, complementary to other recently described genetic mouse models (Trowbridge, et al. 2010). All recent genetic hyposerotonergic models focused on reducing 5-HT production either by targeting the central 5-HT synthesis enzyme, tryptophan hydroxylase 2 (TPH2) (Alenina, et al. 2009; Beaulieu, et al. 2008; Gutknecht, et al. 2008; Savelieva, et al. 2008) or by invalidating the transcription factors controlling differentiation of raphe neurons such as *pet1* and *Imx1B* (Dai, et al. 2008; Hendricks, et al. 2003; Kiyasova, et al. 2011; Zhao, et al. 2006). The more severe 5-HT depletion observed here (-95%), compared with previous models (-70-90%), is likely due to the fact that increased 5-HT degradation, when VMAT2 is absent, affects all sources of 5-HT (e.g, produced by TPH1/TPH2). The present observations, consistent with Tph2 knockout mice (Alenina, et al. 2009; Gutknecht, et al. 2008), showed both a normal development of the raphe neurons, and a normal density of 5-HT terminals in the hippocampus and the cerebral cortex of VMAT2^{sert-cre} mice. Subtle developmental defects may nonetheless exist given the large body of evidence supporting the role of 5-HT in the maturation of neural circuits (Trowbridge, et al. 2010).

Normal morphology of 5-HT neurons and brain specificity provides two major advantages of genetic models in general compared to pharmacological depletion methods such as, respectively, lesions of 5-HT neurons with 5,7-dihydroxytryptamine and depletion with p-chlorophenylalanine (PCPA). Compared to the Tph2 knockout which irreversibly inactivates 5-HT synthesis, the VMAT2^{sert-cre} mutation has also the advantage of rapid reversibility via MAO inhibition since TPH2 is not targeted or down regulated. Overall, VMAT2 selective deletion should allow more direct explorations of the function of monoamine release in otherwise normally developed raphe neurons.

Behavioral characterization of the VMAT2^{sert-cre} mice showed that depletion of central 5-HT stores reduces anxiety. This finding is in agreement with reports in several genetic models of 5-HT deficient mice (Dai, et al. 2008; Kiyasova, et al. 2011) and with numerous studies using pharmacological approaches to decrease brain 5-HT in rats (Graeff 2004; Griebel 1995). Furthermore, decreased 5-HT input at several receptors (including the 5-HT_{2A}

and 5-HT_{2C} subtypes) clearly reduces anxiety in mice (Heisler, et al. 2007; Mongeau, et al. 2010; Weisstaub, et al. 2006).

VMAT2^{sert-cre} mice were first tested in the most standard model, the elevated plus maze (EPM), having a strong validity for anxiolysis mediated by the GABAergic system, but not so much, it seems from previous studies (McCreary, et al. 1996), for the serotonergic system. Indeed, the effect of altering 5-HT on the behaviors observed in the EPM was argued to be the overall result of a balance between distinct 5-HT systems in different brain areas. For example, microinjection of a 5-HT_{2C} agonist generated opposite effects in the EPM depending on the brain areas targeted (Cornelio and Nunes-de-Souza 2007; Nunes-de-Souza, et al. 2008). This might explain the lack of changes in VMAT2^{sert-cre} mice observed here with the EPM. The observed decrease in exploratory behavior of VMAT2^{sert-cre} mice, as in other hyposerotonergic models (Dringenberg, et al. 1995; Hendricks, et al. 2003), is also a confounding factor for the interpretation of EPM data. In contrast, consistent effects of 5-HT depletion have been noted in several models involving conflicts, where reduced 5-HT tone was linked to decreased anxiety-like behaviors (Graeff 2004). In the NSF, which involves a conflict between the drive to feed and the risk assessment behaviors triggered by the unfamiliar environment, VMAT2^{sert-cre} mice showed an anxiolytic-like behavioral profile. This agrees with the anxiolytic-like effect of PCPA-induced 5-HT depletion (Bechtholt, et al. 2007) and with observations in other 5-HT depleted mutant mice (Dai, et al. 2008; Kiyasova, et al. 2011).

It is also interesting to note that VMAT2^{sert-cre} mice spent more time struggling to escape than control mice in the TST. This is coherent with observations in the TPH1/TPH2 KO mice which displayed increased struggling time in the forced swim test (Savelieva, et al. 2008). The increase of struggling or escape-like behavior of VMAT2^{sert-cre} mice in the TST might be mechanistically similar to the increase in ultrasound-induced flight also observed here with these mutants. Both of these effects can potentially be accounted for by a lack of inhibitory effect of 5-HT at the midbrain level (Kiser and Lebovitz 1975). As far as we know, the present genetic invalidation study is the first which clearly indicates a tonic inhibitory role of endogenous 5-HT on the expression of active defense behaviors in reaction to fear stimuli. Previous pharmacological studies in rats showed that flight behaviors induced by an aversive ultrasound are decreased by the 5-HT agonist mCPP (Beckett, et al. 1996). Furthermore, treatment with the MAOI phenelzine decreased flight behavior in the mouse defense battery test, and this was mostly apparent after chronic compared to acute treatment (Griebel, et al. 1998). In our study, we have performed a long term, rather than a short term, MAOI treatment

to optimally enhance 5-HT neurotransmission via the desensitization of 5-HT_{1A} autoreceptors (Mongeau, et al. 1997), which were found to be hypersensitive in VMAT2^{sert-cre} mice (Fig 5).

In relation with depression, it is generally believed that a reduced brain 5-HT tone results in depressed-like behaviors in escape-related models of depression such as the TST or the forced swim test (FST). However, although 5-HT is necessary for the action of antidepressant drugs in these models, 5-HT depletion with PCPA generally fails to alter baseline immobility (Cryan, et al. 2005; O'Leary, et al. 2007). In contrast, depleting catecholamines in adult mice strongly increases baseline immobility in the TST (O'Leary, et al. 2007). Constitutive knock-downs of VMAT2 (VMAT2 +/-), which reduces the release of all monoamines, also results in an increased immobility in the FST and the TST (Fukui, et al. 2007). However, the present observation that selective deletion of VMAT2 in serotonergic neurons decreased, rather than increased, immobility in the TST, together with previous observation (Savelieva, et al. 2008) on TPH1/TPH2-KO mice subjected to the FST, indicate that a depletion of 5-HT is insufficient to induce depression-like behaviors in such escape-related tests.

Furthermore, the antidepressant-like effect observed in the TST in VMAT2^{sert-cre} mice might not be paradoxical considering that antidepressant drugs exert their effect in the TST after acute rather than chronic treatment (Cryan, et al. 2005). It is important to emphasize here that although chronic treatments increase 5-HT neurotransmission, acute administrations do not (Mongeau, et al. 1997). The transient surges of extracellular 5-HT levels, associated with acute antidepressant drugs, trigger strong inhibition of both 5-HT neuronal firing and release through negative autoreceptors feedback (Auerbach, et al. 1995; Hajos, et al. 1995; Hervas and Artigas 1998; Hjorth and Auerbach 1994).

Conclusion and perspectives

Genetic invalidation of VMAT2 in 5-HT neurons provides an interesting model to test the function of endogenous 5-HT release in normally developed 5-HT raphe neurons. Using this model we show that decrease of 5-HT results in an anxiolytic profile in a conflict test, contrasting with an increase in acute stress or innate fear stimulus-induced escape-like behaviors. Chronic treatment with a MAOI prevented the behavioral abnormality of VMAT2^{sert-cre} mice in terms of defense to an innately aversive stimulus. Interestingly, flight reactions have often been used in validated models of panic disorders (Griebel, et al. 1996)

and chronic MAOIs are well known to be effective anti-panic agents (Bakish, et al. 1993). Incidentally, these data address new questions as to whether extrasynaptic or non-vesicular 5-HT release mechanisms might be involved in the therapeutic effects of this class of antidepressant drugs.

Disclosure of interest:

The authors declare no conflict of interest.

Acknowledgements:

We thank Xiaoxi Zhuang and René Hen for the SERT-Cre mouse line. Funding for this project was from Agence Nationale de la Recherche (ANR605-neur-046), NeRF (for NNN), and from the European Commission (FP7-health-2007-A-201714). We thank all members of the DEVANX project for stimulating discussions and suggestions. NNN was supported by Region Ile de France (NeRF). CBPM was funded by a studentship from the Ministère de l'Education Nationale et de la Recherche (France). SLD was supported by fellowships from IBRO and from Region Ile de France DIM STEM and SD by a LeFoulon-Delalande fellowship.

Figure Legends

Fig. 1 – Conditional ablation of the *Vmat2* gene

Schematic representation of the wild-type, targeted and mutated *Vmat2* alleles. Two *loxP* sites and a neomycin-selectable marker flanked by *FRT* sites were inserted by homologous recombination into the introns flanking the first *Vmat2* coding exon. Correct targeting event in one positive ES cell clone was evaluated by Southern blotting with a probe directed against the neomycin sequence after hydrolysis with four different restriction enzymes. The location of the restriction sites is indicated on the targeted allele (N, NsiI; Sc, ScaI; Sp, SpeI; S, SacI). Theoretical sizes of the fragments (in kb) are indicated in brackets. The neomycin cassette was subsequently excised *in vivo* by Flp-mediated recombination to produce the floxed allele.

Fig. 2 - Distribution of VMAT2 and serotonergic markers in VMAT2^{sert-cre} mice vs control mice.

A - VMAT2 immunostaining shows the major sites of VMAT2 expression in control and VMAT2^{sert-cre} mice. Coronal sections at comparable levels in the raphe, the locus coeruleus, the substantia nigra, and the hypothalamus from P7 mice. VMAT2 immunostaining is abolished in the raphe neurons of the VMAT2^{sert-cre} mice compared to control mice, whereas immunostaining is unchanged in the noradrenergic, the dopaminergic or the histaminergic neurons in the other brain areas. **B** - A drastic depletion of 5-HT contents is visible with immunohistochemistry in both the raphe and the forebrain of VMAT2^{sert-cre} mice compared to control mice. A faint 5-HT immunoreactivity remains visible in the raphe neurons (arrowhead) of VMAT2^{sert-cre} mice. **C** - Tryptophan hydroxylase 2 *in situ* hybridization shows the distribution of neurons in the dorsal raphe of VMAT2^{sert-cre} mice and the histogram shows the unchanged density of positive cells compared to controls (values are mean density on a surface of 784 μm^2 , error bars=S.E.M.; n=5). 5-HT transporter immunohistochemistry shows labeled axons in the hippocampus of VMAT2^{sert-cre} mice with normal appearance, and there was no significant change in the density of fibers in the stratum moleculare of the dentate gyrus compared to controls (values are mean intersecting fibers on a surface of 0.462 mm^2 , error bars=S.E.M.; n=5-6).

Fig. 3 –Tissue levels of monoamines in the brain and the periphery

A - Tissue levels of 5-HT and 5-HIAA were determined in various dissected brain areas from adult control (open bars) and VMAT2^{sert-cre} mice (black bars). There was a highly significant decrease in 5-HT levels in all examined brain areas. ***: P<0.0001 ; Student's t-test ; error bars=S.E.M.; n=5-6. **B** - Tissue levels of NA in the cortex and the hippocampus and DA in the striatum. There was no change of NA in the cortex but a small reduction in the hippocampus, while striatal DA levels were found unchanged using the Student's t-test; n = 5-6, **, P<0.01. **C** - Levels of 5-HT in the gut and in the blood. There were no changes in the gut, whereas 5-HT was significantly decreased in blood ***: P<0.0001; Student's t-test; n=5-8.

Fig. 4 – Uptake and release of [³H] 5-HT using synaptosome preparations obtained from whole brain in controls, SERT^{cre/+} and VMAT2^{sert-cre} mice.

A - The release of endogenous 5-HT evoked with varying concentration of potassium in synaptosomes from WT mice was not observed in synaptosomes from VMAT2^{sert-cre} mice (n=3). **B** - [³H]5-HT uptake in VMAT2^{sert-cre} or reserpine-treated (0.1 μM) synaptosomes compared to WT or SERT^{cre/+} synaptosomes. There was less total uptake in synaptosomes from VMAT2^{sert-cre} mice or from WT mice treated with the VMAT inhibitor reserpine (Vmax; VMAT2^{sert-cre} = 2.0 ± 0.1 fmol/min, reserpine = 2.6 ± 0.07, mean ± S.E.M., n = 3) compared to synaptosomes from WT or SERT^{cre/+} mice (Vmax: control = 6.8 ± 0.5 fmol/min; SERT^{cre/+} = 5.5 ± 0.3, n = 3). There were no significant changes (using one-way Anova) in the Km values between groups (WT = 18.8 ± 4.5 nM; VMAT2^{sert-cre} = 13.5 ± 3.2 nM; SERT^{cre/+} = 12.7 ± 3 nM; reserpine = 12.25 ± 1.4 nM; means ± S.E.M., n = 3). **C** – The concentration response curve of the MDMA-induced [³H]5-HT release was slightly shifted to the left in preloaded synaptosomes from VMAT2^{sert-cre} mice or reserpine-treated synaptosomes. **D**- There were no major changes in potassium-induced [³H]5-HT release between the various synaptosome preparations in conditions weakly dependent on calcium, n=3. **E**- In conditions in which potassium-induced release is fully dependent on the presence of calcium in the incubation buffer (brief stimulation in absence of pargyline, WT synaptosomes top panel) there was no significant release in preloaded synaptosomes from VMAT2^{sert-cre} mice (bottom panel).

Fig. 5 – [³⁵S]GTP-γ-S binding in the dorsal raphe nucleus and the hippocampus after stimulation with the 5-HT_{1A} agonist 5-carboxamidotryptamine (5-CT). **A** - There was an increased coupling efficiency as shown by more agonist-induced [³⁵S]GTP-γ-S binding in the raphe of VMAT2^{sert-cre} (open circles) versus control mice (filled circles). Two-way Anova indicated a significant (P < 0.001) main effect of the genotype [F(1,35) = 19], of 5-CT concentration [F(3,35) = 34], and a marginally significant (P = 0.06) genotype x 5-CT interaction [F(3,35) = 2.8]. Post-hoc Bonferroni's tests indicated significant differences at specific concentrations * P < 0.05, ** P < 0.01. **B** - There were no changes in the hippocampus. Error bars=S.E.M., n=6.

Fig. 6 - The VMAT2^{sert-cre} mutation decreased anxiety and locomotion but increased reactivity to stress. **A** - There was no change in the time spent in the open arms or in the number of open arm entries, but there was a significant decrease in the total number of entries in VMAT2^{sert-cre} mutants compared to control mice. **B** - There was a significant decrease of basal locomotor activity in the VMAT2^{sert-cre} mutants as measured over a 15 min period in an actimeter. **C** - The latency to feed when mice were placed in an unfamiliar cage, but not home cage, was decreased in VMAT2^{sert-cre} mutants. **D** - Tail suspension test shows an increase in the time spent struggling, and decreased immobility time in VMAT2^{sert-cre} mice compared to control mice. Student's t-tests, * P < 0.05, **P < = 0.01. Error bars=S.E.M., n=5-12.

Fig. 7 - Inverse relationship between brain tissue levels of 5-HT and aversive ultrasound-induced flight behaviors in VMAT2^{sert-cre} mice. **A** - There was an enhancement of flight behaviors in reaction to the aversive ultrasound (1 min fast sweep 17-20 kHz, 85 dB) in VMAT2^{sert-cre} mice compared to control mice, which was reversed by a chronic treatment with pargyline (70 mg/kg x day for 3 weeks). * P < 0.01 using Bonferonni's test. Error bars=S.E.M., n=3-5. **B-C'** - 5-HT-immunoreactive neurons were observed in the raphe area (B) and positive fibers were observed in dorsolateral periaqueductal gray areas in sections from VMAT2^{sert-cre} treated with pargyline (C). This staining was absent in VMAT2^{sert-cre} treated with saline (B' and C'). **D** - Chronic pargyline reversed the severe 5-HT depletion occurring in VMAT2^{sert-cre} mice, and markedly increased 5-HT levels (in the hippocampus). Bonferonni's test indicated a significant decrease in 5-HT levels in VMAT2^{sert-cre} mutants compared to control mice (### P < 0.001, # P < 0.05), and significant increases of 5-HT levels after pargyline (***) P < 0.001) compared to control mice.

References

- Adell A and Artigas F (1998). A microdialysis study of the in vivo release of 5-HT in the median raphe nucleus of the rat. *Br. J. Pharmacol.* **125**: 1361-1367.
- Alenina N, Kikic D, Todiras M, Mosienko V, Qadri F, Plehm R et al., (2009). Growth retardation and altered autonomic control in mice lacking brain serotonin. *Proc. Natl. Acad. Sci. U. S. A* **106**: 10332-10337.
- Alvarez C, Vitalis T, Fon EA, Hanoun N, Hamon M, Seif I et al., (2002). Effects of genetic depletion of monoamines on somatosensory cortical development. *Neuroscience* **115**: 753-764.
- Attwell D, Barbour B, and Szatkowski M (1993). Nonvesicular release of neurotransmitter. *Neuron* **11**: 401-407.
- Auerbach SB, Lundberg JF, and Hjorth S (1995). Differential inhibition of serotonin release by 5-HT and NA reuptake blockers after systemic administration. *Neuropharmacology* **34**: 89-96.
- Bakish D, Saxena BM, Bowen R, and D'Souza J (1993). Reversible monoamine oxidase-A inhibitors in panic disorder. *Clin. Neuropharmacol.* **16 Suppl 2**: S77-S82.
- Bally-Cuif L and Wassef M (1994). Ectopic induction and reorganization of Wnt-1 expression in quail/chick chimeras. *Development* **120**: 3379-3394.
- Beaulieu JM, Zhang X, Rodriguiz RM, Sotnikova TD, Cools MJ, Wetsel WC et al., (2008). Role of GSK3 beta in behavioral abnormalities induced by serotonin deficiency. *Proc. Natl. Acad. Sci. U. S. A* **105**: 1333-1338.
- Bechtholt AJ, Hill TE, and Lucki I (2007). Anxiolytic effect of serotonin depletion in the novelty-induced hypophagia test. *Psychopharmacology (Berl)* **190**: 531-540.
- Beckett SR, Aspley S, Graham M, and Marsden CA (1996). Pharmacological manipulation of ultrasound induced defence behaviour in the rat. *Psychopharmacology (Berl)* **127**: 384-390.
- Berton O and Nestler EJ (2006). New approaches to antidepressant drug discovery: beyond monoamines. *Nat. Rev. Neurosci.* **7**: 137-151.
- Bunin MA, Prioleau C, Mailman RB, and Wightman RM (1998). Release and uptake rates of 5-hydroxytryptamine in the dorsal raphe and substantia nigra reticulata of the rat brain. *J. Neurochem.* **70**: 1077-1087.
- Bunin MA and Wightman RM (1999). Paracrine neurotransmission in the CNS: involvement of 5-HT. *Trends Neurosci.* **22**: 377-382.
- Buu NT (1989). Modification of vesicular dopamine and norepinephrine by monoamine oxidase inhibitors. *Biochem. Pharmacol.* **38**: 1685-1692.

Christiansen L, Tan Q, Iachina M, Bathum L, Kruse TA, McGue M et al., (2007). Candidate gene polymorphisms in the serotonergic pathway: influence on depression symptomatology in an elderly population. *Biol. Psychiatry* **61**: 223-230.

Cornelio AM and Nunes-de-Souza RL (2007). Anxiogenic-like effects of mCPP microinfusions into the amygdala (but not dorsal or ventral hippocampus) in mice exposed to elevated plus-maze. *Behav. Brain Res.* **178**: 82-89.

Cote F, Thevenot E, Fligny C, Fromes Y, Darmon M, Ripoche MA et al., (2003). Disruption of the nonneuronal tph1 gene demonstrates the importance of peripheral serotonin in cardiac function. *Proc. Natl. Acad. Sci. U. S. A* **100**: 13525-13530.

Cryan JF, Mombereau C, and Vassout A (2005). The tail suspension test as a model for assessing antidepressant activity: review of pharmacological and genetic studies in mice. *Neurosci. Biobehav. Rev.* **29**: 571-625.

Dai JX, Han HL, Tian M, Cao J, Xiu JB, Song NN et al., (2008). Enhanced contextual fear memory in central serotonin-deficient mice. *Proc. Natl. Acad. Sci. U. S. A* **105**: 11981-11986.

Dringenberg HC, Hargreaves EL, Baker GB, Cooley RK, and Vanderwolf CH (1995). p-chlorophenylalanine-induced serotonin depletion: reduction in exploratory locomotion but no obvious sensory-motor deficits. *Behav. Brain Res.* **68**: 229-237.

Erickson JD and Eiden LE (1993). Functional identification and molecular cloning of a human brain vesicle monoamine transporter. *J. Neurochem.* **61**: 2314-2317.

Erickson JD, Schafer MK, Bonner TI, Eiden LE, and Weihe E (1996). Distinct pharmacological properties and distribution in neurons and endocrine cells of two isoforms of the human vesicular monoamine transporter. *Proc. Natl. Acad. Sci. U. S. A* **93**: 5166-5171.

Evans SM and Collard KJ (1988). The mechanism by which monoamine oxidase inhibitors give rise to a non-calcium-dependent component in the depolarization-induced release of 5-HT from rat brain synaptosomes. *Br. J Pharmacol.* **95**: 950-956.

Fabre V, Beaufour C, Evrard A, Rioux A, Hanoun N, Lesch KP et al., (2000). Altered expression and functions of serotonin 5-HT1A and 5-HT1B receptors in knock-out mice lacking the 5-HT transporter. *Eur. J. Neurosci.* **12**: 2299-2310.

Fon EA, Pothos EN, Sun BC, Killeen N, Sulzer D, and Edwards RH (1997). Vesicular transport regulates monoamine storage and release but is not essential for amphetamine action. *Neuron* **19**: 1271-1283.

Freis ED (1954). Mental depression in hypertensive patients treated for long periods with large doses of reserpine. *N. Engl. J. Med.* **251**: 1006-1008.

Fukui M, Rodriguiz RM, Zhou J, Jiang SX, Phillips LE, Caron MG et al., (2007). Vmat2 heterozygous mutant mice display a depressive-like phenotype. *J. Neurosci.* **27**: 10520-10529.

Gaspar P, Duyckaerts C, Alvarez C, Javoy-Agid F, and Berger B (1991). Alterations of dopaminergic and noradrenergic innervations in motor cortex in Parkinson's disease. *Ann. Neurol.* **30**: 365-374.

Graeff FG (2004). Serotonin, the periaqueductal gray and panic. *Neurosci. Biobehav. Rev* **28**: 239-259.

Gray EG and Whittaker VP (1962). The isolation of nerve endings from brain: an electron-microscopic study of cell fragments derived by homogenization and centrifugation. *J. Anat.* **96**: 79-88.

Gray, J.A. and McNaughton, N. (2000): *The neuropsychology of anxiety*, Oxford, Oxford Medical Publications.

Griebel G (1995). 5-Hydroxytryptamine-interacting drugs in animal models of anxiety disorders: more than 30 years of research. *Pharmacol. Ther.* **65**: 319-395.

Griebel G, Blanchard DC, and Blanchard RJ (1996). Predator-elicited flight responses in Swiss-Webster mice: an experimental model of panic attacks. *Prog. Neuropsychopharmacol. Biol. Psychiatry* **20**: 185-205.

Griebel G, Curet O, Perrault G, and Sanger DJ (1998). Behavioral effects of phenelzine in an experimental model for screening anxiolytic and anti-panic drugs: correlation with changes in monoamine-oxidase activity and monoamine levels. *Neuropharmacology* **37**: 927-935.

Gutierrez B, Rosa A, Papiol S, Arrufat FJ, Catalan R, Salgado P et al., (2007). Identification of two risk haplotypes for schizophrenia and bipolar disorder in the synaptic vesicle monoamine transporter gene (SVMT). *Am. J. Med. Genet. B Neuropsychiatr. Genet.* **144B**: 502-507.

Gutknecht L, Waider J, Kraft S, Kriegebaum C, Holtmann B, Reif A et al., (2008). Deficiency of brain 5-HT synthesis but serotonergic neuron formation in Tph2 knockout mice. *J. Neural Transm.* **115**: 1127-1132.

Hajos M, Gartside SE, and Sharp T (1995). Inhibition of median and dorsal raphe neurones following administration of the selective serotonin reuptake inhibitor paroxetine. *Naunyn Schmiedeberg's Arch. Pharmacol.* **351**: 624-629.

Heisler LK, Zhou L, Bajwa P, Hsu J, and Tecott LH (2007). Serotonin 5-HT(2C) receptors regulate anxiety-like behavior. *Genes Brain Behav.* **6**: 491-496.

Hekmatpanah CR and Peroutka SJ (1990). 5-hydroxytryptamine uptake blockers attenuate the 5-hydroxytryptamine-releasing effect of 3,4-methylenedioxymethamphetamine and related agents. *Eur. J Pharmacol.* **177**: 95-98.

Hendricks TJ, Fyodorov DV, Wegman LJ, Lelutiu NB, Pehek EA, Yamamoto B et al., (2003). Pet-1 ETS gene plays a critical role in 5-HT neuron development and is required for normal anxiety-like and aggressive behavior. *Neuron* **37**: 233-247.

Henry JP, Sagne C, Bedet C, and Gasnier B (1998). The vesicular monoamine transporter: from chromaffin granule to brain. *Neurochem. Int.* **32**: 227-246.

Hervas I and Artigas F (1998). Effect of fluoxetine on extracellular 5-hydroxytryptamine in rat brain. Role of 5-HT autoreceptors. *Eur. J Pharmacol.* **358**: 9-18.

- Hjorth S and Auerbach SB (1994). Further evidence for the importance of 5-HT_{1A} autoreceptors in the action of selective serotonin reuptake inhibitors. *Eur. J. Pharmacol.* **260**: 251-255.
- Holtje M, Winter S, Walther D, Pahner I, Hortnagl H, Ottersen OP et al., (2003). The vesicular monoamine content regulates VMAT2 activity through Galphaq in mouse platelets. Evidence for autoregulation of vesicular transmitter uptake. *J. Biol. Chem.* **278**: 15850-15858.
- Kiser RS and Lebovitz RM (1975). Monoaminergic mechanisms in aversive brain stimulation. *Physiol Behav.* **15**: 47-53.
- Kiyasova V, Fernandez SP, Laine J, Stankovski L, Muzerelle A, Doly S et al., (2011). A genetically defined morphologically and functionally unique subset of 5-HT neurons in the mouse raphe nuclei. *J Neurosci.* **31**: 2756-2768.
- Lucki I (1998). The spectrum of behaviors influenced by serotonin. *Biol. Psychiatry* **44**: 151-162.
- Mannoury la Cour C, El Mestikawy S, Hanoun N, Hamon M, and Lanfumey L (2006). Regional differences in the coupling of 5-hydroxytryptamine-1A receptors to G proteins in the rat brain. *Mol. Pharmacol.* **70**: 1013-1021.
- McCreary AC, McBlane JW, Spooner HA, and Handley SL (1996). 5-HT systems and anxiety: multiple mechanisms in the elevated X-maze. *Pol. J. Pharmacol.* **48**: 1-12.
- McKenna DJ, Guan XM, and Shulgin AT (1991). 3,4-Methylenedioxyamphetamine (MDA) analogues exhibit differential effects on synaptosomal release of 3H-dopamine and 3H-5-hydroxytryptamine. *Pharmacol. Biochem. Behav.* **38**: 505-512.
- Mongeau R, Blier P, and de Montigny C (1997). The serotonergic and noradrenergic systems of the hippocampus: their interactions and the effects of antidepressant treatments. *Brain Res. Brain Res. Rev* **23**: 145-195.
- Mongeau R, de Montigny C, and Blier P (1994). Activation of 5-HT₃ receptors enhances the electrically evoked release of [3H]noradrenaline in rat brain limbic structures. *Eur. J. Pharmacol.* **256**: 269-279.
- Mongeau R, Martin CB, Chevarin C, Maldonado R, Hamon M, Robledo P et al., (2010). 5-HT_{2c} receptor activation prevents stress-induced enhancement of brain 5-HT turnover and extracellular levels in the mouse brain: modulation by chronic paroxetine treatment. *J. Neurochem.* **115**: 438-449.
- Mongeau R, Miller GA, Chiang E, and Anderson DJ (2003). Neural correlates of competing fear behaviors evoked by an innately aversive stimulus. *J Neurosci.* **23**: 3855-3868.
- Morilak DA and Frazer A (2004). Antidepressants and brain monoaminergic systems: a dimensional approach to understanding their behavioural effects in depression and anxiety disorders. *Int. J. Neuropsychopharmacol.* **7**: 193-218.
- Narboux-Nême N, Mongeau R, Sagne C, Angenard G, Hamon M, Martres MP et al., (2009). Severe serotonin depletion, growth and behavioral abnormalities in conditional vesicular monoamine transporter 2 knockout mouse. *Society for Neuroscience Abstract*: 90.9.

- Narboux-Neme N, Pavone LM, Avallone L, Zhuang X, and Gaspar P (2008). Serotonin transporter transgenic (SERT^{Cre}) mouse line reveals developmental targets of serotonin specific reuptake inhibitors (SSRIs). *Neuropharmacology* **55**: 994-1005.
- Njus D, Kelley PM, and Harnadek GJ (1986). Bioenergetics of secretory vesicles. *Biochim. Biophys. Acta* **853**: 237-265.
- Nunes-de-Souza V, Nunes-de-Souza RL, Rodgers RJ, and Canto-de-Souza A (2008). 5-HT₂ receptor activation in the midbrain periaqueductal grey (PAG) reduces anxiety-like behaviour in mice. *Behav. Brain Res.* **187**: 72-79.
- O'Connor JJ and Kruk ZL (1991). Fast cyclic voltammetry can be used to measure stimulated endogenous 5-hydroxytryptamine release in untreated rat brain slices. *J. Neurosci. Methods* **38**: 25-33.
- O'Leary OF, Bechtholt AJ, Crowley JJ, Hill TE, Page ME, and Lucki I (2007). Depletion of serotonin and catecholamines block the acute behavioral response to different classes of antidepressant drugs in the mouse tail suspension test. *Psychopharmacology (Berl)* **192**: 357-371.
- Renoir T, Paizanis E, El Yacoubi M, Saurini F, Hanoun N, Melfort M et al., (2008). Differential long-term effects of MDMA on the serotonergic system and hippocampal cell proliferation in 5-HTT knock-out vs. wild-type mice. *Int. J. Neuropsychopharmacol.* **11**: 1149-1162.
- Savelieva KV, Zhao S, Pogorelov VM, Rajan I, Yang Q, Cullinan E et al., (2008). Genetic disruption of both tryptophan hydroxylase genes dramatically reduces serotonin and affects behavior in models sensitive to antidepressants. *PLoS. One.* **3**: e3301.
- Shih, J.C., Grimsby, J., and Chen, K., Molecular biology of Monoamines oxidases A and B: their role in the degradation of serotonin. In: *Handbook of Experimental Pharmacology*, Springer-Verlag, Berlin, 1997, pp. 655-670.
- Trowbridge S, Narboux-Neme N, and Gaspar P (2010). Genetic Models of Serotonin (5-HT) Depletion: What do They Tell Us About the Developmental Role of 5-HT? *Anat. Rec. (Hoboken.)*.
- Vitalis T, Fouquet C, Alvarez C, Seif I, Price D, Gaspar P et al., (2002). Developmental expression of monoamine oxidases A and B in the central and peripheral nervous systems of the mouse. *J. Comp Neurol.* **442**: 331-347.
- Wang YM, Gainetdinov RR, Fumagalli F, Xu F, Jones SR, Bock CB et al., (1997). Knockout of the vesicular monoamine transporter 2 gene results in neonatal death and supersensitivity to cocaine and amphetamine. *Neuron* **19**: 1285-1296.
- Weisstaub NV, Zhou M, Lira A, Lambe E, Gonzalez-Maeso J, Hornung JP et al., (2006). Cortical 5-HT_{2A} receptor signaling modulates anxiety-like behaviors in mice. *Science* **313**: 536-540.
- Wu Y, Wang W, Diez-Sampedro A, and Richerson GB (2007). Nonvesicular inhibitory neurotransmission via reversal of the GABA transporter GAT-1. *Neuron* **56**: 851-865.

Zhao S, Edwards J, Carroll J, Wiedholz L, Millstein RA, Jaing C et al., (2006). Insertion mutation at the C-terminus of the serotonin transporter disrupts brain serotonin function and emotion-related behaviors in mice. *Neuroscience* **140**: 321-334.

Zhuang X, Masson J, Gingrich JA, Rayport S, and Hen R (2005). Targeted gene expression in dopamine and serotonin neurons of the mouse brain. *J. Neurosci. Methods* **143**: 27-32.

Fig. 1 Narboux-Nême et al.

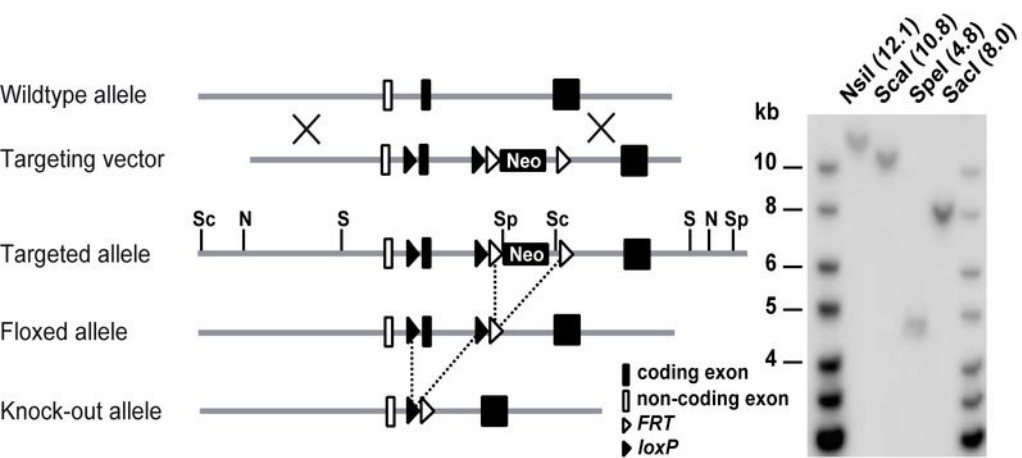
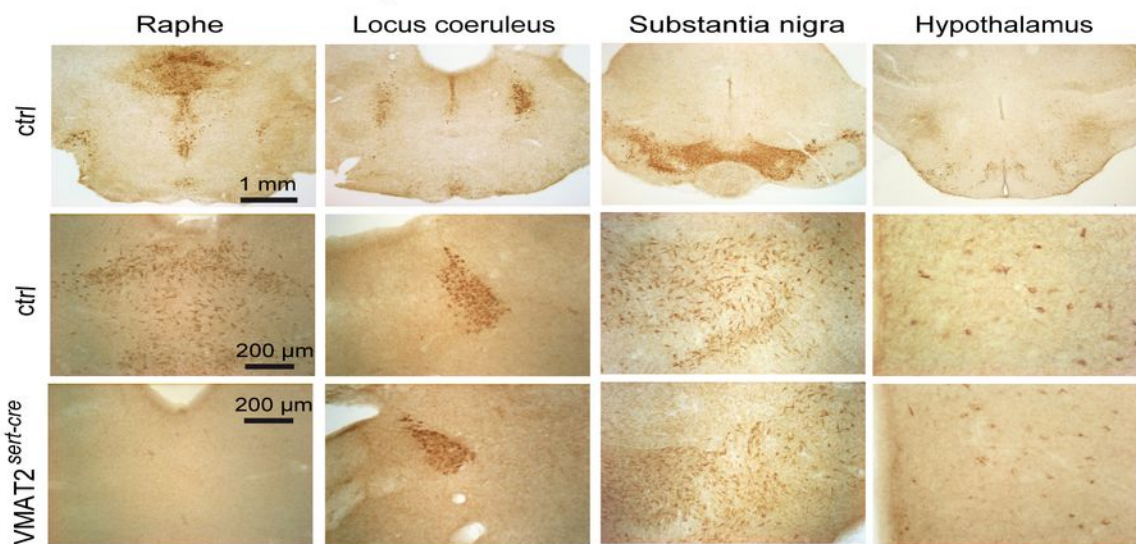
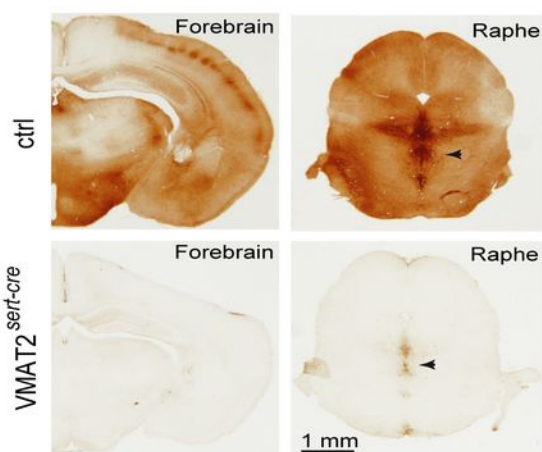

Fig. 2 Narboux-Nême et al.

A- VMAT2 Immunolabeling



B- 5-HT immunoreactivity



C- Other serotonergic labelings

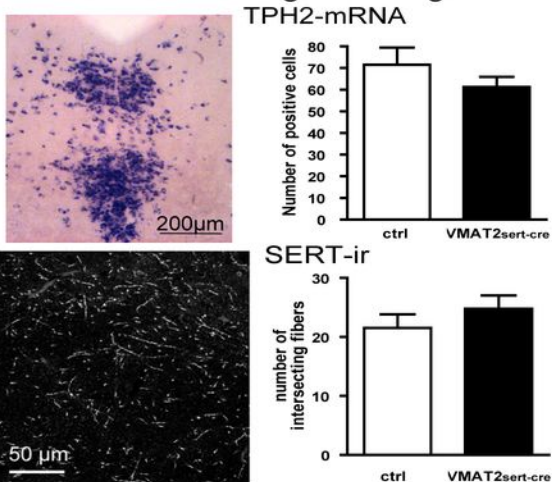
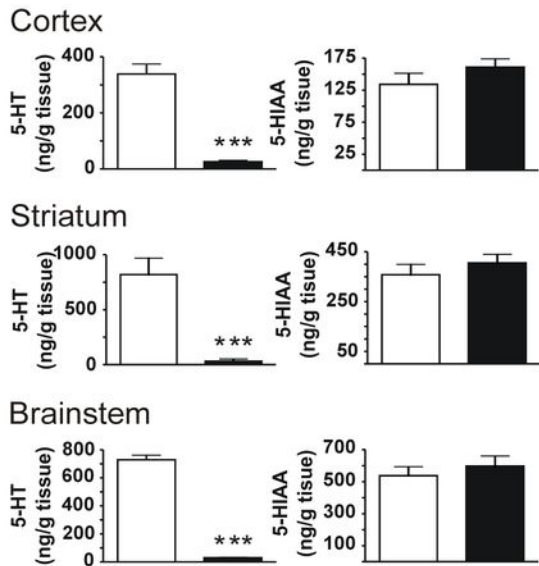
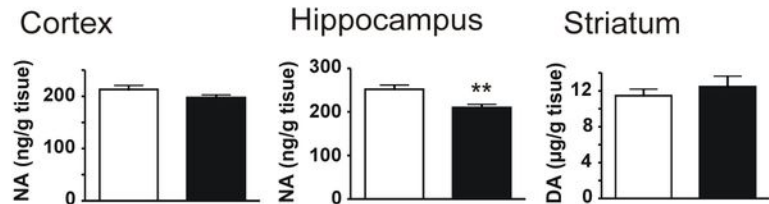

Fig.3 Narboux-Nême et al.

A) Brain serotonin



B) Brain catecholamines



C) Serotonin in the periphery

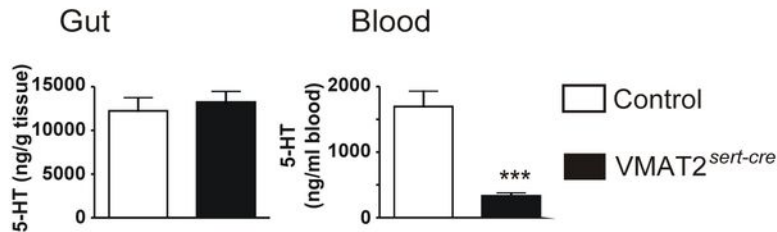

Fig. 4 Narboux-Nême et al.

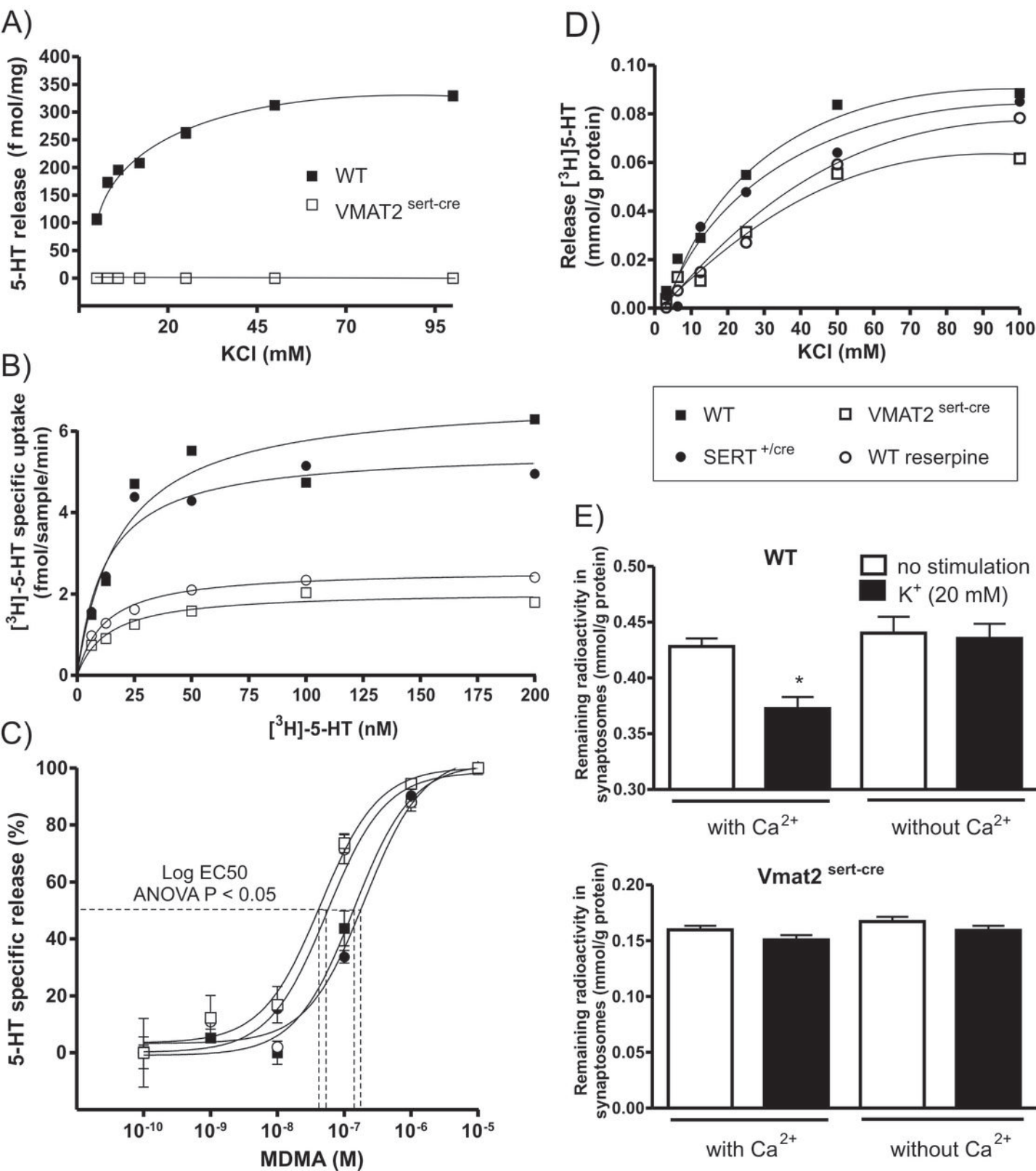

Fig. 5 Narboux-Nême et al.

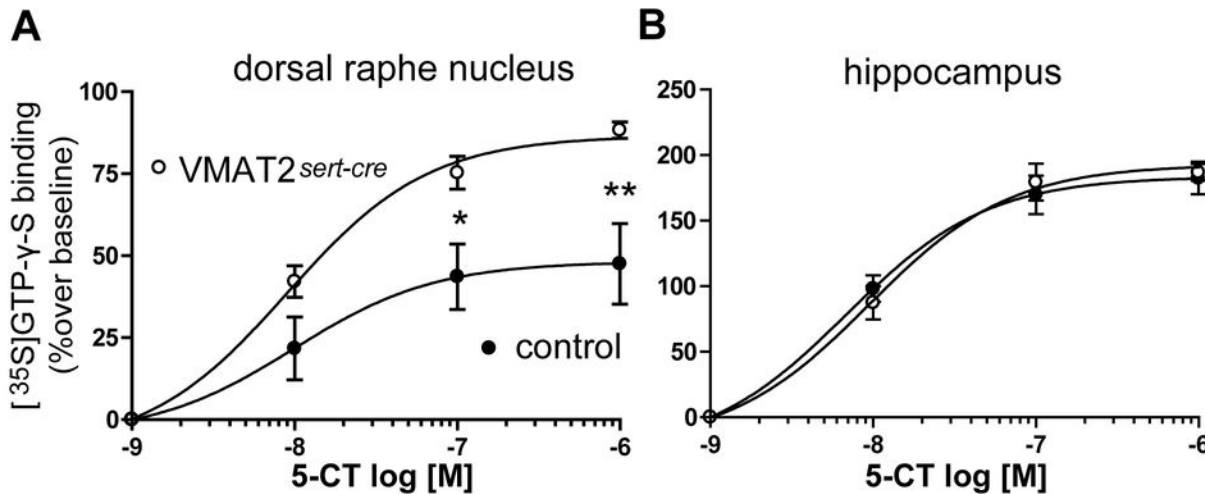

Fig. 6 Narboux-Nême et al.

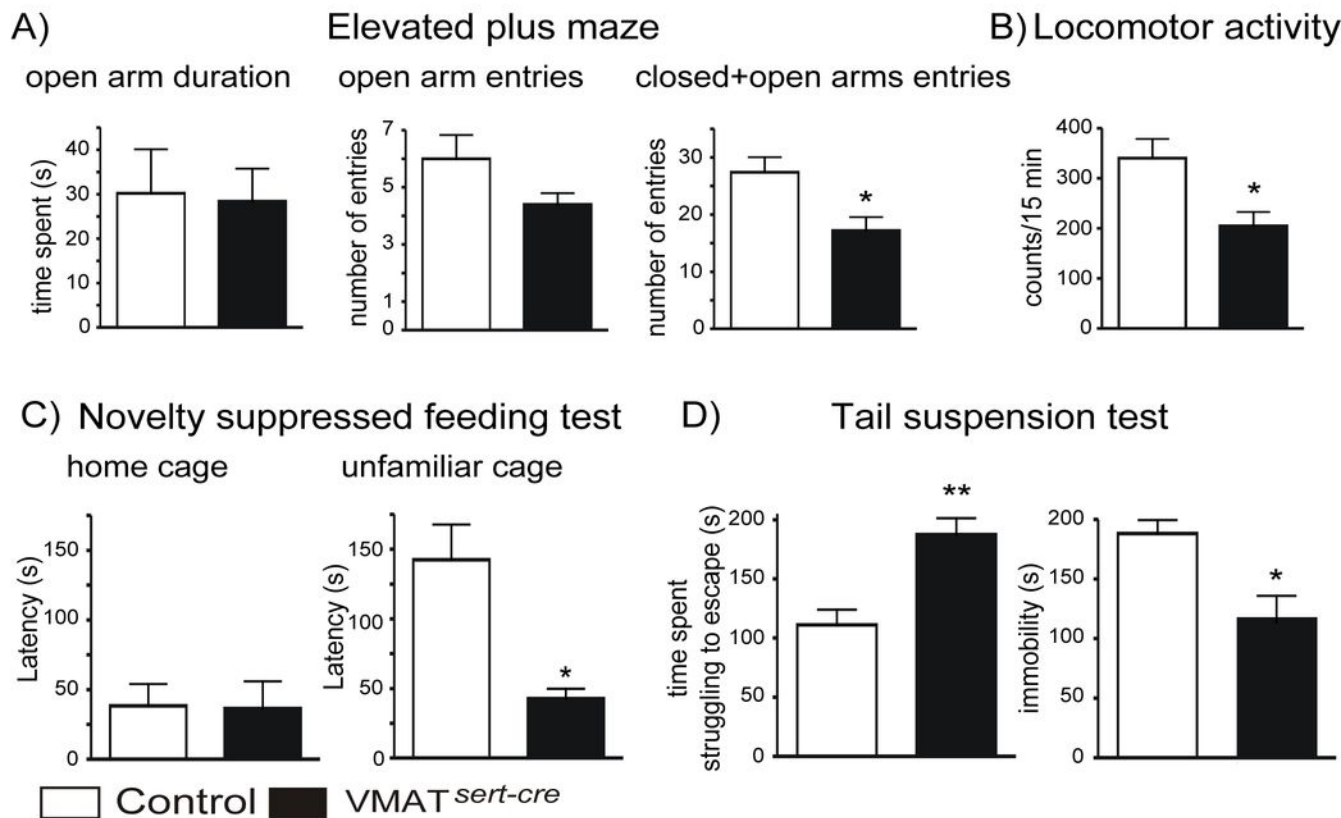

Fig. 7 Narboux-Nême et al.

