



HAL
open science

Discrete vector potential representation of a divergence-free vector field in three-dimensional domains: numerical analysis of a model problem

François Dubois

► **To cite this version:**

François Dubois. Discrete vector potential representation of a divergence-free vector field in three-dimensional domains: numerical analysis of a model problem. *SIAM Journal on Numerical Analysis*, 1990, 27 (5), pp.1103-1141. hal-00660366

HAL Id: hal-00660366

<https://hal.science/hal-00660366>

Submitted on 16 Jan 2012

HAL is a multi-disciplinary open access archive for the deposit and dissemination of scientific research documents, whether they are published or not. The documents may come from teaching and research institutions in France or abroad, or from public or private research centers.

L'archive ouverte pluridisciplinaire **HAL**, est destinée au dépôt et à la diffusion de documents scientifiques de niveau recherche, publiés ou non, émanant des établissements d'enseignement et de recherche français ou étrangers, des laboratoires publics ou privés.

Discrete vector potential representation of a divergence-free vector field in three-dimensional domains: numerical analysis of a model problem

François Dubois ^{ab}

^a *Ecole Polytechnique, Centre de Mathématiques Appliquées*

F-91128 Palaiseau Cedex, France

^b *Aerospatiale, Division Systèmes Stratégiques et Spatiaux,*

Direction Technique, BP 96, F 78133 Les Mureaux, Cedex France.

october 1988 *

Abstract. - For the representation of a divergence-free vector field defined on a bounded simply connected domain of \mathbb{R}^3 with a smooth boundary by its curl and its normal component on the boundary, a mixed formulation also involving a vector potential is proposed. The vector fields are discretized with help of curved finite elements that are conforming in $H(\text{div})$ or $H(\text{curl})$. A discrete gauge condition is proposed to assume the uniqueness of the stream function. Optimal error estimates are derived, and a numerical experiment is presented.

Keywords: mixed finite elements, curved boundaries, discrete gauge condition.

AMS classification: 65N30.

* This contribution has been published in *SIAM Journal of Numerical Analysis*, volume 27, issue 5, p. 1103-1141, october 1990.

DISCRETE VECTOR POTENTIAL REPRESENTATION OF A
DIVERGENCE FREE VECTOR FIELD IN THREE DIMENSIONAL
DOMAINS : NUMERICAL ANALYSIS OF A MODEL PROBLEM.

François DUBOIS*
october 1988

ABSTRACT

For the representation of a divergence free vector field defined on a bounded simply connected domain of \mathbb{R}^3 with a smooth boundary by its curl and its normal component on the boundary, a mixed formulation involving also a vector potential is proposed. The vector fields are discretized with help of curved finite elements which are conforming in $H(\text{div})$ or $H(\text{curl})$. A discrete gauge condition is proposed to assume the uniqueness of the stream function. Optimal error estimates are derived. A numerical experiment is presented.

* ECOLE POLYTECHNIQUE, Centre de Mathématiques Appliquées
F-91128 Palaiseau Cedex, France.

Present address: AEROSPATIALE, Division Systèmes Stratégiques et
Spatiaux, STMI (Direction Technique) ,
BP 96, F-78133 Les Mureaux Cedex, France.

I - INTRODUCTION

When we study numerical fluid dynamics an important task is the discretization of vector fields \vec{u} which are divergence free (or solenoidal)

$$(1.1) \quad \operatorname{div} \vec{u} = 0$$

with \vec{u} defined on a domain Ω of \mathbb{R}^3 . The major field of application is incompressible hydrodynamics (TEMAM [43]); replacing \vec{u} by the mass flux, the equation (1.1) is also important in stationary compressible aerodynamics (COURANT-FRIEDRICHS [15]). A conforming or non-conforming discretization which respects the condition (1.1) is difficult with the finite element method (HECHT [29], GUSTAFSON-HARTMAN [28]). On the other hand a natural idea to satisfy exactly (1.1) is to represent \vec{u} in terms of a vector potential $\vec{\Psi}$:

$$(1.2) \quad \vec{u} = \operatorname{curl} \vec{\Psi}$$

but the uniqueness of $\vec{\Psi}$ is never assumed and a gauge condition has to be added. A classical way is to prescribe the Coulomb gauge (e.g. JACKSON [30]):

$$(1.3) \quad \operatorname{div} \vec{\Psi} = 0.$$

Moreover, different choices of the boundary conditions for $\vec{\Psi}$ are possible. The studies of BERNARDI [9] and BENDALI-DOMINGUEZ-GALLIC [6] have given existence and uniqueness results. Practically the stream function is just a tool for the representation of the field \vec{u} and must be computed easily if we give some constraints on this field. In this paper, we choose to fix the vorticity $\vec{\omega}$ and the mass-inflow g over the entire boundary

$$(1.4) \quad \operatorname{curl} \vec{u} = \vec{\omega} \quad \text{in } \Omega$$

$$(1.5) \quad \vec{u} \cdot \vec{n} = g \quad \text{on } \partial\Omega$$

We remark that if the relations (1.2) and (1.5) are satisfied then the average of the mass-inflow g on each component of the boundary of Ω is null. This fact precludes flow problems with sinks and sources.

With these assumptions we restrict ourselves to a simple problem. More sophisticated models, for example, are the Stokes and Navier-Stokes equations in $(\vec{\psi}, \vec{\omega})$ formulation (GIRAULT-RAVIART [26]), and the potential isentropic equations of transonic flow (COURANT-FRIEDRICHS [15]). However, even in the linear case of the Stokes problem the numerical analysis of the three-dimensional case is difficult (NEDELEC [38]).

In part II, after recalling classical results on vector fields, we split the linear problem in an homogeneous problem in Ω ($g=0$) and a problem on the boundary of Ω ($g \neq 0$). Then a concrete construction method of $\vec{\psi}$ from the only data $(\vec{\omega}, g)$ is presented. In the discretized problem, the compatibility between these two subproblems requires that the discrete field $\vec{\psi}_h$ must have a tangential component on each point of the boundary. Thus in part III we develop curved finite elements conforming in the spaces $H(\text{div})$ and $H(\text{curl})$ which coincide in the straight case with the vectorial finite elements of degree 1 introduced by NEDELEC [37]. Then we derive optimal interpolation errors. Part IV treats the approximation of the homogeneous problem. The major difficulty is the definition of a "good" linear space which guarantees that the discrete potential is unique. Therefore, we adapt the discrete gauge communicated by ROUX [41] to the case of arbitrary simply connected domains in \mathbb{R}^3 . Then we formulate the discrete problem and obtain the error estimate between the velocity field and its approximation. By linearity part V treats only the approximation of an harmonic vector field ($\vec{\omega} = 0$). The boundary finite elements of NEDELEC [34] and BENDALI [3,5], are adapted to $H(\text{curl})$, and a discrete gauge is added to assume the uniqueness of the tangential component of the discrete stream function. Then the error estimation is established.

HYPOTHESES AND NOTATIONS

We define Ω as a connected bounded domain of \mathbb{R}^3 with a regular boundary $\partial\Omega \equiv \Gamma$, and Γ_j ($j=0,1,\dots,N_\Gamma$) as the connected components of Γ . We assume that Γ_0 is the boundary of the unbounded component of $\mathbb{R}^3 \setminus \Omega$. Classically (e.g. NEDELEC [34,35]) the structure of regular (of C^2 class) manifold with boundary ensures the existence of $(p+1)$ open sets $\Omega_0, \Omega_1, \dots, \Omega_p$ of \mathbb{R}^3 covering Ω :

$$\Omega \subset \Omega_0 \cup \left(\bigcup_{i=1}^p \Omega_i \right)$$

Moreover the p last Ω_i 's are covering the boundary:

$$\Gamma \subset \left(\bigcup_{i=1}^p \Omega_i \right) \quad \Gamma \cap \Omega_0 = \emptyset$$

The local charts μ_i are compatible diffeomorphisms of class C^2 :

$$(1.6) \quad \mu_i : \Omega_i \rightarrow]-1,1[]^3 \quad i = 0, \dots, p$$

$$(1.7) \quad \mu_i \Big|_{\Omega_i \cap \Omega_j} = \mu_j \Big|_{\Omega_i \cap \Omega_j} \quad \forall i, j = 0, 1, \dots, p$$

and Ω is supposed to be locally on one side of its boundary:

$$(1.8) \quad \mu_i(\Gamma \cap \Omega_i) =]-1,1[]^2 \times \{0\} \quad i = 1, \dots, p$$

$$(1.9) \quad \mu_i(\Omega \cap \Omega_i) =]-1,1[]^2 \times]0,1[\quad i = 1, \dots, p$$

We finish this geometrical description by introducing the normal projector on the boundary (e.g. DE RHAM [16]):

PROPOSITION 1.1: There exists $\delta > 0$ and a neighborhood U_δ of Γ :

$$U_\delta = \left\{ x \in \mathbb{R}^3, \text{dist}(x, \Gamma) \leq \delta \right\}$$

such that each point x of U_δ admits a unique projection $P_\Gamma x$ on Γ :

$$\forall x \in U_\delta, \exists! y = P_\Gamma x \in \Gamma, \vec{xy} \text{ normal to } \Gamma.$$

We make now one hypothesis on the algebraic topology of Ω , then we introduce some notations relating to boundary operators. The domain Ω is supposed to have N_H holes (if $N_H=0$, Ω is simply connected) and it is possible to find N_H regular surfaces Σ_k such that $\left(\Omega \setminus \left(\bigcup_{k=1}^{N_H} \Sigma_k \right) \right)$ is a simply connected domain of \mathbb{R}^3 (FOAIS-TEMAM [22]). The following

operators on the manifold Γ are defined in CHOQUET-BRUHAT [13] for example:

* Surface gradient $\nabla_{\Gamma} w$ and surface curl, $\text{curl}_{\Gamma} w$, of a scalar function defined on Γ : $\text{curl}_{\Gamma} w = \nabla_{\Gamma} w \times \vec{n}$ with \vec{n} the external normal to Γ .

* Surface curl, $\text{curl}_{\Gamma} \vec{\xi}$, and surface divergence $\text{div}_{\Gamma} \vec{\xi}$ of a tangent vectorial function defined on Γ . We have: $\text{div}_{\Gamma} \vec{\xi} = \text{curl}_{\Gamma} (\vec{n} \times \vec{\xi})$. Finally the Laplace-Beltrami operator Δ_{Γ} satisfies:

$$-\Delta_{\Gamma} w = \text{curl}_{\Gamma} (\text{curl}_{\Gamma} w) = -\text{div}_{\Gamma} (\nabla_{\Gamma} w)$$

By duality these operators are also defined for scalar (T) or vectorial (\vec{U}) distributions on Γ :

$$\langle \nabla_{\Gamma} T, \vec{\xi} \rangle_{\Gamma} = -\langle T, \text{div}_{\Gamma} \vec{\xi} \rangle_{\Gamma}$$

$$\langle \text{curl}_{\Gamma} T, \vec{\xi} \rangle_{\Gamma} = \langle T, \text{curl}_{\Gamma} \vec{\xi} \rangle_{\Gamma}$$

$$\langle \text{curl}_{\Gamma} \vec{U}, w \rangle_{\Gamma} = \langle \vec{U}, \text{curl}_{\Gamma} w \rangle_{\Gamma}$$

$$\langle \text{div}_{\Gamma} \vec{U}, w \rangle_{\Gamma} = \langle \vec{U}, \nabla_{\Gamma} w \rangle_{\Gamma}$$

In these notations, the duality product $\langle \cdot, \cdot \rangle_{\Gamma}$ of two vectors is the scalar product according to the metric g_{ij} on the manifold (e.g. CHOQUET-BRUHAT [13]):

$$\langle \vec{U}, \vec{\xi} \rangle_{\Gamma} = \sum_{i,j} \langle U_i, g_{ij} \xi_j \rangle_{\Gamma}$$

* More generally the scalar product between two vectors $\vec{\varphi}, \vec{\psi}$ defined in Ω , or two tangent vectors on Γ , is denoted by $\vec{\varphi} \cdot \vec{\psi}$ [or $(\vec{\varphi}, \vec{\psi})$ when \cdot is used for the image $A \cdot \vec{u}$ of a vector \vec{u} by a mapping A], the

tangential component on Γ of a vector $\vec{\varphi}$ is:

$$\vec{\Pi}\vec{\varphi} = \vec{n} \times (\vec{\varphi} \times \vec{n}) = (\vec{n} \times \vec{\varphi}) \times \vec{n}$$

and we have a Green formula for regular vector fields:

$$(1.10) \quad \int_{\Omega} \vec{\varphi} \cdot \text{curl} \vec{\Psi} \, dx = \int_{\Omega} \text{curl} \vec{\varphi} \cdot \vec{\Psi} \, dx + \int_{\partial\Omega} (\vec{\varphi} \times \vec{n}) \cdot \vec{\Psi} \, d\gamma$$

Moreover $\text{Span} \langle u_1, \dots, u_n \rangle$ is the linear space of all the linear combinations of the vectors u_1, \dots, u_n and tA is the transpose of a matrix A .

II - THE CONTINUOUS PROBLEM

We first recall the definitions of some classical Sobolev spaces. Then the major results concerning the decomposition of vector fields reviewed in BENDALI-DOMINGUEZ-GALLIC [6] and also established by FRIEDRICHS [23], FOIAS-TEMAM [22] and GEORGESCU [24] are given. We also propose a mixed formulation in the variables $(\vec{u}, \vec{\psi})$ to compute both the velocity field \vec{u} and the potential $\vec{\psi}$ in the particular case of homogeneous constraints on \vec{u} :

$$(2.1) \quad \operatorname{div} \vec{u} = 0 \quad \Omega$$

$$(2.2) \quad \vec{u} \cdot \vec{n} = 0 \quad \text{on } \partial\Omega$$

In the non-homogeneous case, i.e. if

$$(2.3) \quad \vec{u} \cdot \vec{n} = g \quad \text{on } \partial\Omega$$

we first consider a boundary problem for which we give a mixed formulation. Then the extension Theorem of J.L. Lions (LIONS-MAGENES [32]) allows a theoretical approach to compute the vector potential $\vec{\psi}$ with

$$(2.4) \quad \vec{u} = \operatorname{curl} \vec{\psi}$$

if \vec{u} satisfies both (2.1) and (2.3).

1) SOME HILBERT SPACES

The Sobolev spaces $L^2(\Omega)$, $H^1(\Omega)$, $H^2(\Omega)$ are Hilbert spaces with their natural norms $\| \cdot \|_{0,\Omega}$, $\| \cdot \|_{1,\Omega}$, and $\| \cdot \|_{2,\Omega}$ respectively (e.g. ADAMS [1]). We set also :

$$H_0^1(\Omega) = \left\{ w \in H^1(\Omega) , w|_{\Gamma} = 0 \right\}$$

$$L_0^2(\Omega) = \left\{ w \in L^2(\Omega) , \int_{\Omega} w \, dx = 0 \right\}$$

Following DUVAUT-LIONS [20], we define

$$H(\operatorname{div}, \Omega) = \left\{ \vec{v} \in (L^2(\Omega))^3, \operatorname{div} \vec{v} \in L^2(\Omega) \right\}$$

$$H(\operatorname{curl}, \Omega) = \left\{ \vec{\varphi} \in (L^2(\Omega))^3, \operatorname{curl} \vec{\varphi} \in (L^2(\Omega))^3 \right\}$$

and the associated norms $\| \cdot \|_{H(\operatorname{div})}$ and $\| \cdot \|_{H(\operatorname{curl})}$. We also consider vector fields which are normal on the boundary :

$$H^0(\operatorname{curl}, \Omega) = \left\{ \vec{\varphi} \in H(\operatorname{curl}, \Omega), \vec{\varphi} \times \vec{n}|_{\Gamma} = 0 \right\}$$

The classical spaces $H^s(\Gamma)$ (s real) of scalar functions (and distributions) defined on the Ω -boundary are equipped with their natural norms $\| \cdot \|_{s, \Gamma}$. The duality product between $H^{-\frac{1}{2}}(\Gamma)$ and $H^{\frac{1}{2}}(\Gamma)$ is denoted by $\langle \dots \rangle_{\Gamma}$, and $\mathcal{TH}^s(\Gamma)$ are tangent vector fields on Γ (e.g. [3]) :

$$\mathcal{TH}^s(\Gamma) = \left\{ \vec{\eta} \in (H^s(\Gamma))^3, \vec{\eta} \cdot \vec{n} \equiv 0 \right\} .$$

Consider now some particular spaces useful in this paper :

DEFINITION 2.1

$$W^2(\Omega) = \left\{ \vec{\varphi} \in (H^1(\Omega))^3, \operatorname{curl} \vec{\varphi} \in (H^1(\Omega))^3 \right\}$$

$$M(\Gamma) = \left\{ g \text{ distribution on } \Gamma, \langle g, 1 \rangle_{\Gamma_i} = 0, \forall i=0, \dots, N_{\Gamma} \right\} .$$

The notations introduced above for the norms of scalar fields will also be used for the norms of the corresponding vector fields when there is no ambiguity.

PROPOSITION 2.1 : *The norm*

$$\| \vec{\varphi} \|_{W^2(\Omega)} = \left(\| \vec{\varphi} \|_{1, \Omega}^2 + \| \operatorname{curl} \vec{\varphi} \|_{1, \Omega}^2 \right)^{\frac{1}{2}}$$

defines on $W^2(\Omega)$ a structure of Hilbert space.

2) DECOMPOSITION OF VECTOR FIELDS

In this paragraph, we recall general results on vector fields defined on a regular bounded domain Ω of \mathbb{R}^3 . We refer to BENDALI-DOMINGUEZ-GALLIC [6] and included references for the results.

DEFINITION 2.2 *The two sets*

$$\begin{aligned} X_T(\Omega) &= \left\{ \vec{v} \in (L^2(\Omega))^3, \operatorname{div} \vec{v} \in L^2(\Omega), \operatorname{curl} \vec{v} \in (L^2(\Omega))^3, \vec{v} \cdot \vec{n} \in H^{\frac{1}{2}}(\Gamma) \right\} \\ X_N(\Omega) &= \left\{ \vec{v} \in (L^2(\Omega))^3, \operatorname{div} \vec{v} \in L^2(\Omega), \operatorname{curl} \vec{v} \in (L^2(\Omega))^3, \vec{v} \times \vec{n} \in TH^{\frac{1}{2}}(\Gamma) \right\} \end{aligned}$$

are Hilbert spaces equipped with their natural norms $\| \cdot \|_T$ and $\| \cdot \|_N$ respectively.

THEOREM 2.1 *The spaces $X_T(\Omega)$ and $X_N(\Omega)$ are equal to $(H^1(\Omega))^3$ algebraically and topologically.*

We introduce tangential and normal harmonic vector fields, related to topological invariants of Ω .

DEFINITION 2.3

$$\begin{aligned} H_T(\Omega) &= \left\{ \vec{v} \in (L^2(\Omega))^3, \operatorname{div} \vec{v} = 0, \operatorname{curl} \vec{v} = 0, \vec{v} \cdot \vec{n}|_{\Gamma} = 0 \right\} \\ H_N(\Omega) &= \left\{ \vec{v} \in (L^2(\Omega))^3, \operatorname{div} \vec{v} = 0, \operatorname{curl} \vec{v} = 0, \vec{v} \times \vec{n}|_{\Gamma} = 0 \right\} \end{aligned}$$

THEOREM 2.2 *We have $\dim H_T(\Omega) = N_H$, $\dim H_N(\Omega) = N_T$. There exists a unique basis $(\vec{\theta}_i^T)_{1 \leq i \leq N_H}$ of $H_T(\Omega)$ (resp. $(\vec{\theta}_j^N)_{1 \leq j \leq N_T}$ of $H_N(\Omega)$) such that :*

$$\int_{\Sigma_i} \vec{\theta}_k^T \cdot \vec{n} \, d\gamma = \delta_{ik} \quad \forall i, k = 1, \dots, N_H$$

$$\text{(respectively } \int_{\Gamma_j} \vec{\theta}_l^N \cdot \vec{n} \, d\gamma = \delta_{jl} \quad \forall j, l = 1, \dots, N_T).$$

PROPOSITION 2.2 The orthogonal projectors P_T and P_N , $P_T : X_T(\Omega) \rightarrow H_T(\Omega)$ and $P_N : X_N(\Omega) \rightarrow H_N(\Omega)$ with respect to the associated scalar products admit the following expressions :

$$(2.5) \quad P_T \vec{v} = \sum_{i=1}^{N_H} \left(\int_{\Omega} \vec{v} \cdot \tilde{\theta}_i^T dx \right) \tilde{\theta}_i^T$$

$$(2.6) \quad P_N \vec{v} = \sum_{j=1}^{N_{\Gamma}} \left(\int_{\Omega} \vec{v} \cdot \tilde{\theta}_j^N dx \right) \tilde{\theta}_j^N$$

for some basis $\tilde{\theta}_i^T$ of $H_T(\Omega)$ (resp. $\tilde{\theta}_j^N$ of $H_N(\Omega)$). Thus the expressions (2.5)-(2.6) define P_T and P_N as orthogonal projectors from $(L^2(\Omega))^3$ onto $H_T(\Omega)$ and $H_N(\Omega)$ respectively.

PROOF OF PROPOSITION 2.2

The auxiliary basis $\tilde{\theta}_i^T$ and $\tilde{\theta}_j^N$ are constructed explicitly by FOIAS-TEMAM [22], DOMINGUEZ [17], and BENDALI-GALLIC [7] as gradients of some harmonic functions defined on $(\Omega \setminus \bigcup_{i=1}^{N_H} \Sigma_i)$ and on Ω respectively. The end of the proof is clear. ■

PROPOSITION 2.3 Let \vec{v} be a solenoidal vector field ($\text{div } \vec{v} = 0$) in $(H^1(\Omega))^3$. We have :

$$(2.7) \quad P_N \vec{v} = \sum_{j=1}^{N_{\Gamma}} \left(\int_{\Gamma_j} \vec{v} \cdot \vec{n} d\gamma \right) \tilde{\theta}_j^N$$

$$(2.8) \quad P_T \vec{v} = \sum_{i=1}^{N_H} \left(\int_{\Sigma_i} \vec{v} \cdot \vec{n} d\gamma \right) \tilde{\theta}_i^T \quad \text{if } \vec{v} \cdot \vec{n}|_{\Gamma} = 0 .$$

PROOF OF PROPOSITION 2.3

We only prove (2.7) since the proof of (2.8) is similar. Following BENDALI-GALLIC [7], let ψ_j be the solution of

$$\begin{cases} \Delta \psi_j = 0 & \Omega \\ \psi_j = 0 & \Gamma_0 \\ \psi_j = \delta_{ij} & \Gamma_i \end{cases} \quad i = 1, \dots, N_\Gamma$$

We set $\tilde{\theta}_j^N = \nabla \psi_j$ and we integrate by parts. We have :

$$\int_{\Omega} \vec{v} \cdot \tilde{\theta}_j^N \, dx = \int_{\partial\Omega} \vec{v} \cdot \vec{n} \, \psi_j \, d\gamma$$

if $\operatorname{div} \vec{v} = 0$. Thus (2.7) holds. ■

THEOREM 2.3 *The mappings*

$$\begin{aligned} X_T(\Omega) \ni \vec{v} &\mapsto |\vec{v}|_T = \left(\|\operatorname{curl} \vec{v}\|_{0,\Omega}^2 + \|\operatorname{div} \vec{v}\|_{0,\Omega}^2 + \|\mathbb{P}_T \vec{v}\|_{0,\Omega}^2 + \|\vec{v} \cdot \vec{n}\|_{\frac{1}{2},\Gamma}^2 \right)^{\frac{1}{2}} \\ X_N(\Omega) \ni \vec{v} &\mapsto |\vec{v}|_N = \left(\|\operatorname{curl} \vec{v}\|_{0,\Omega}^2 + \|\operatorname{div} \vec{v}\|_{0,\Omega}^2 + \|\mathbb{P}_N \vec{v}\|_{0,\Omega}^2 + \|\vec{v} \times \vec{n}\|_{\frac{1}{2},\Gamma}^2 \right)^{\frac{1}{2}} \end{aligned}$$

are norms on $X_T(\Omega)$ and $X_N(\Omega)$ which are equivalent to the $H^1(\Omega)$ norm.

DEFINITION and PROPOSITION 2.4 *We set*

$$W^1(\Omega) = \left\{ \vec{\varphi} \in (H^1(\Omega))^3, \operatorname{div} \vec{\varphi} = 0, \vec{\varphi} \times \vec{n} \Big|_{\Gamma} = 0, \int_{\Gamma_j} \vec{\varphi} \cdot \vec{n} \, d\gamma = 0, \forall j = 1, \dots, N_\Gamma \right\}$$

Then the mapping $W^1(\Omega) \ni \vec{\varphi} \mapsto \|\operatorname{curl} \vec{\varphi}\|_{0,\Omega} \in \mathbb{R}$ is a norm on $W^1(\Omega)$ which is equivalent to the H^1 norm.

PROOF Direct consequence of Proposition 2.3 and Theorem 2.3. ■

THEOREM 2.4 (Decomposition of vector fields). For \vec{u} given in $(L^2(\Omega))^3$, we have the following decompositions :

(i)

$$(2.9) \quad \vec{u} = \nabla w + \operatorname{curl} \vec{\varphi} + \sum_{i=1}^{N_H} \left(\int_{\Omega} \vec{u} \cdot \tilde{\theta}_i^T \, dx \right) \vec{\theta}_i^T$$

with unique $(w, \vec{\varphi})$ verifying

$$(2.10) \quad \begin{cases} w \in H^1(\Omega) \cap L_0^2(\Omega) \\ \vec{\varphi} \in W^1(\Omega) \end{cases}$$

(ii)

$$(2.11) \quad \vec{u} = \nabla p + \text{curl} \vec{\psi} + \sum_{j=1}^{N_\Gamma} \left(\int_{\Omega} \vec{u} \cdot \tilde{\theta}_j^N \, dx \right) \vec{\theta}_j^N$$

with unique $(p, \vec{\psi})$ verifying

$$(2.12) \quad \begin{cases} p \in H_0^1(\Omega) \\ \vec{\psi} \in (H^1(\Omega))^3, \text{div} \vec{\psi} = 0, \vec{\psi} \cdot \vec{n}|_{\Gamma} = 0, P_T \vec{\psi} = 0 \end{cases}$$

Moreover if \vec{u} belongs to $(H^m(\Omega))^3$ ($m \geq 0$) then $w, p, \vec{\varphi}, \vec{\psi}$ belong to $H^{m+1}(\Omega)$.

The decomposition (2.9) (resp (2.11)) of the field \vec{u} is into three orthogonal components of the type ∇w (resp ∇p), plus $\text{curl} \vec{\varphi}$ (resp $\text{curl} \vec{\psi}$), plus some vector lying in $H_T(\Omega)$ (resp $H_N(\Omega)$). However the decomposition (2.5) (resp (2.6)) of the projector P_T (resp P_N) is not splitted into orthogonal components in $L^2(\Omega)$ and the auxiliary vectors $\tilde{\theta}_i^T$ (resp $\tilde{\theta}_j^N$) introduced at Proposition 2.2 constitute the dual basis of the $\vec{\theta}_i^T$ (resp $\vec{\theta}_j^N$).

The results of Theorem 2.4 have been used by EL DABAGHI-PIRONNEAU in their numerical work [21].

3) MIXED FORMULATION OF THE HOMOGENEOUS PROBLEM

If a vector field \vec{u} admits a representation of the type $\vec{u} = \text{curl } \vec{\phi}$, we have clearly :

$$(2.13) \quad \text{div } \vec{u} = 0$$

but we also have constraints on the normal component.

LEMMA 2.1 *Let $\vec{\phi}$ be in the space $W^1(\Omega)$. We have in the space $H^{\frac{1}{2}}(\Gamma)$:*
 $\text{curl } \vec{\phi} \cdot \vec{n} = \text{div}_{\Gamma} \vec{\phi} \times \vec{n} = \text{curl}_{\Gamma} \Pi \vec{\phi}$.

PROOF OF LEMMA 2.1

Consider a regular function w on Γ and a lifting of w on $\bar{\Omega}$ also denoted by w . We have

$$\begin{aligned} \langle \text{curl } \vec{\varphi} \cdot \vec{n}, w \rangle_{\Gamma} &= \int_{\Omega} \text{div}(w \text{curl } \vec{\varphi}) \, dx = \int_{\Omega} \nabla w \cdot \text{curl } \vec{\varphi} \, dx \\ &= -\langle \nabla w, \vec{\varphi} \times \vec{n} \rangle_{\Gamma} = \langle \text{div}_{\Gamma} \vec{\varphi} \times \vec{n}, w \rangle_{\Gamma} \end{aligned}$$

by definition of the operator div_{Γ} . Moreover for an arbitrary tangent vector field $\vec{\xi}$ on Γ , we have $\text{curl}_{\Gamma}(\vec{n} \times \vec{\xi}) = \text{div}_{\Gamma} \vec{\xi}$ (e.g. CHOQUET-BRUHAT [13]).

PROPOSITION 2.5 (FOIAS-TEMAM [22]) *Let $\vec{u} \in (L^2(\Omega))^3$ and $\vec{\psi} \in H(\text{curl}, \Omega)$ satisfying $\vec{u} = \text{curl } \vec{\psi}$. Then we have :*

$$(2.14) \quad P_N \vec{u} = 0.$$

If $\vec{u} \in (H^1(\Omega))^3$ and $\vec{\psi} \in W^2(\Omega)$, this condition can be written :

$$\int_{\Gamma_i} \vec{u} \cdot \vec{n} \, d\gamma = 0 \quad \text{for } i = 0, 1, \dots, N_{\Gamma}.$$

PROOF OF PROPOSITION 2.5

From Proposition 2.2 (equation (2.6)) we have :

$$\begin{aligned} \int_{\Omega} \vec{u} \cdot \tilde{\theta}_j^N \, dx &= \int_{\Omega} \text{curl } \vec{\psi} \cdot \tilde{\theta}_j^N \, dx \\ &= \int_{\Omega} \vec{\psi} \cdot \text{curl } \tilde{\theta}_j^N \, dx - \int_{\partial\Omega} \vec{\psi} \cdot (\vec{n} \times \tilde{\theta}_j^N) \, d\gamma \end{aligned}$$

because $\tilde{\theta}_j^N \in H_N(\Omega)$. Then $P_N \vec{u} = 0$. The end of the proof is a consequence of Proposition 2.3. Directly we have from (2.12) and Lemma 2.1 $\vec{u} \cdot \vec{n} = \text{div}_{\Gamma}(\vec{\psi} \times \vec{n})$ on $\partial\Omega$ and we integrate this function on the component Γ_i .

We suppose now that the hypotheses (2.13).(2.14) are true. We emphasize that in practice, the condition (2.14) precludes flow problems with sinks and sources. We give in the following of part II a way to construct a vector potential $\vec{\psi}$. We begin with the simple case $\vec{u} \cdot \vec{n} \equiv 0$ on Γ .

THEOREME 2.5 *The mixed problem*

$$(2.15) \quad \left\{ \begin{array}{l} \vec{u} \in (L^2(\Omega))^3, \quad \vec{\psi} \in W^1(\Omega) \\ \int_{\Omega} \vec{u} \cdot \vec{v} \, dx - \int_{\Omega} \text{curl} \vec{\psi} \cdot \vec{v} \, dx = 0 \quad \forall \vec{v} \in (L^2(\Omega))^3 \\ \int_{\Omega} \vec{u} \cdot \text{curl} \vec{\phi} \, dx = \int_{\Omega} \vec{\omega} \cdot \vec{\phi} \, dx \quad \forall \vec{\phi} \in W^1(\Omega) \end{array} \right.$$

admits, for $\vec{\omega}$ given in $(H^1(\Omega)')^3$, a unique solution which satisfies $\text{div} \vec{u} = 0$. Moreover if $\vec{\omega} \in (L^2(\Omega))^3$ such that (2.13).(2.14) is satisfied, \vec{u} belongs to $(H^1(\Omega))^3$ and we have

$$(2.16) \quad \vec{u} \cdot \vec{n} = 0 \quad \Gamma$$

$$(2.17) \quad \text{curl} \vec{u} = \vec{\omega} \quad \Omega$$

$$(2.18) \quad \|\vec{u}\|_{0,\Omega} \leq C \|\vec{\omega}\|_{0,\Omega}$$

for some constant C .

PROOF OF THEOREM 2.5

• The existence and uniqueness are consequences of the Brezzi-Babuska condition (BREZZI [11], BABUSKA [2]), which is satisfied because on one hand

$$(L^2(\Omega))^6 \ni (\vec{u}, \vec{v}) \rightarrow \int_{\Omega} \vec{u} \cdot \vec{v} \, dx \in \mathbb{R} \quad \text{is coercive}$$

and on the other hand

$$\sup_{\vec{v} \in (L^2(\Omega))^3} \frac{\int_{\Omega} \text{curl} \vec{\phi} \cdot \vec{v} \, dx}{\|\vec{v}\|_{0,\Omega}} \geq \|\text{curl} \vec{\phi}\|_{0,\Omega} \geq C \|\vec{\phi}\|_{1,\Omega}$$

(we choose $\vec{v} = -\text{curl} \vec{\phi}$ to obtain the first inequality and we refer to Proposition 2.4 for the second). The first equation implies $\vec{u} = \text{curl} \vec{\psi}$ and therefore $\text{div} \vec{u} = 0$.

- If $\vec{\omega}$ belongs to $(L^2(\Omega))^3$ and satisfies both $\operatorname{div} \vec{\omega} = 0$ and $P_N \vec{\omega} = 0$,

The Theorem 2.4 (ii) shows that we can write :

$$(2.19) \quad \vec{\omega} = \nabla p + \operatorname{curl} \vec{J}$$

The scalar p belonging to $H_0^1(\Omega)$, we have $p=0$. Besides we have also $\vec{J} \in (H^1(\Omega))^3$, $\operatorname{div} \vec{J} = 0$, $\vec{J} \cdot \vec{n}|_{\Gamma} = 0$. We demonstrate now that $\vec{u} - \vec{J}$ belongs to $H_T(\Omega)$, i.e. that the pair $(w, \vec{\varphi})$ of the decomposition of $\vec{u} - \vec{J}$, by means of Theorem 2.4 (i), is equal to zero. We have

$$\int_{\Omega} (\vec{u} - \vec{J}) \cdot \nabla w \, dx = \int_{\partial\Omega} (\vec{u} - \vec{J}) \cdot \vec{n} w \, d\gamma = \int_{\partial\Omega} \vec{u} \cdot \vec{n} w \, d\gamma = 0$$

$$\begin{aligned} \int_{\Omega} (\vec{u} - \vec{J}) \cdot \operatorname{curl} \vec{\varphi} \, dx &= \int_{\Omega} \vec{u} \cdot \operatorname{curl} \vec{\varphi} \, dx - \int_{\Omega} \operatorname{curl} \vec{J} \cdot \vec{\varphi} \, dx \quad \text{because } \vec{\varphi} \times \vec{n} = 0 \\ &= 0 \quad \text{due to (2.15) and (2.19).} \end{aligned}$$

Thus $\vec{u} \in (H^1(\Omega))^3$ and (2.16)–(2.17) are clear. We choose $\vec{\varphi} = \vec{\psi}$ in the second equation of (2.15). From Proposition 2.4, we deduce $\|\vec{u}\|_{0,\Omega}^2 \leq \|\vec{\omega}\|_{0,\Omega} \|\vec{\varphi}\|_{0,\Omega} \leq C \|\vec{\omega}\|_{0,\Omega} \|\operatorname{curl} \vec{\varphi}\|_{0,\Omega}$ which corresponds to (2.18). ■

4) MIXED FORMULATION OF THE BOUNDARY PROBLEM

We suppose in this paragraph that the boundary Γ is connected (if it is not, we just have to replace the function spaces by their $(N_{\Gamma} + 1)$ copies for the different connected components of Γ). We recall first general results on scalar and tangent vector fields on Γ .

THEOREM 2.6 Let s be a real number, g an element of $H^s(\Gamma) \cap M(\Gamma)$.

The problem $-\Delta_{\Gamma} \theta = g$ admits a unique solution $\theta \in H^{s+2}(\Gamma) \cap M(\Gamma)$ satisfying

$\|\theta\|_{s+2,\Gamma} \leq C(s) \|g\|_{s,\Gamma}$ for some constant $C(s)$ independent of g .

PROOF See, e.g. DE RHAM [16] or TREVES [44]. ■

DEFINITION 2.5 We denote by $Y(\Gamma)$ the space of tangent vector fields $\vec{\theta}$ on Γ with $\text{curl}_\Gamma \vec{\theta} = \text{div}_\Gamma \vec{\theta} = 0$. We define $W^{\frac{1}{2}}(\Gamma)$ by

$$W^{\frac{1}{2}}(\Gamma) = \left\{ \vec{n} \in TH^{\frac{1}{2}}(\Gamma), \text{div}_\Gamma \vec{n} = 0, \int_\Gamma \vec{n} \cdot \vec{\theta} \, d\gamma = 0, \forall \vec{\theta} \in Y(\Gamma) \right\} .$$

THEOREM 2.7 (GEORGESCU [24], TREVES [44]) The space $Y(\Gamma)$ is finite-dimensional and there exists some integer r such that $\dim Y(\Gamma) = 2r$. (Γ is diffeomorphic to the torus with r handles). Moreover for s a given real number, the mapping

$$(H^{s+1}(\Gamma) \cap M(\Gamma))^2 \times Y(\Gamma) \ni (p, w, \vec{\theta}) \mapsto \vec{n} = \nabla_\Gamma p + \text{curl}_\Gamma w + \vec{\theta} \in TH^s(\Gamma)$$

defines an algebraic and topologic isomorphism.

Those important results allow to derive a Poincaré-type inequality in the space $W^{\frac{1}{2}}(\Gamma)$.

PROPOSITION 2.6 The mapping $W^{\frac{1}{2}} \ni \vec{n} \mapsto \|\text{curl}_\Gamma \vec{n}\|_{-\frac{1}{2}, \Gamma} \in \mathbb{R}$ is a norm on $W^{\frac{1}{2}}(\Gamma)$ which is equivalent with the norm induced by $TH^{\frac{1}{2}}(\Gamma)$:

$$\exists C > 0, \forall \vec{n} \in W^{\frac{1}{2}}(\Gamma), \|\vec{n}\|_{\frac{1}{2}, \Gamma} \leq C \|\text{curl}_\Gamma \vec{n}\|_{-\frac{1}{2}, \Gamma} .$$

PROOF OF PROPOSITION 2.6

The field $\vec{n} \in TH^{\frac{1}{2}}(\Gamma)$ admits a decomposition given in Theorem 2.7 with p, w in $H^{\frac{3}{2}}(\Gamma) \cap M(\Gamma)$ and $\vec{\theta} \in Y(\Gamma)$. We have clearly : $\Delta_\Gamma p = \text{div}_\Gamma \vec{n} = 0$ then $p=0$ thanks to Theorem 2.6. Moreover, when we integrate \vec{n} against $\vec{\theta}$, we have $\int_\Gamma \vec{n} \cdot \vec{\theta} \, d\gamma = \int_\Gamma \vec{\theta} \cdot \vec{\theta} \, d\gamma = 0$ so $\vec{\theta} = 0$. Then

$$\|\vec{n}\|_{\frac{1}{2},\Gamma} = \|\text{curl}_{\Gamma} w\|_{\frac{1}{2},\Gamma} < \|w\|_{\frac{3}{2},\Gamma} < C \|\text{curl}_{\Gamma} n\|_{-\frac{1}{2},\Gamma}$$

due to (2.20), Theorem 2.6, and $\text{curl}_{\Gamma} \vec{n} \in H^{-\frac{1}{2}}(\Gamma)$, with

$$(2.20) \quad -\Delta_{\Gamma} w = \text{curl}_{\Gamma} \vec{n}$$

Suppose now that the mass flux g across the boundary is given in $M(\Gamma)$. We have seen (Proposition 2.5) that the component $\vec{\xi}$ of the vector potential satisfies :

$$(2.21) \quad \text{curl}_{\Gamma} \vec{\xi} = g$$

If we choose $\vec{\xi}$ in $W^{\frac{1}{2}}(\Gamma)$, we add the continuous gauge condition

$$(2.22) \quad \text{div}_{\Gamma} \vec{\xi} = 0$$

and $\vec{\xi}$ can therefore be rewritten as

$$(2.23) \quad \vec{\xi} = \text{curl}_{\Gamma} \theta$$

We propose now a mixed formulation of the problem (2.21)-(2.23).

PROPOSITION 2.7 *Let g be in $H^{-\frac{1}{2}}(\Gamma) \cap M(\Gamma)$. The mixed problem*

$$(2.24) \quad \left\{ \begin{array}{l} \vec{\xi} \in W^{\frac{1}{2}}(\Gamma) , \theta \in L^2(\Gamma) \cap M(\Gamma) \\ \int_{\Gamma} \vec{\xi} \cdot \vec{n} \, d\gamma - \int_{\Gamma} \theta \, \text{curl}_{\Gamma} \vec{n} \, d\gamma = 0 \quad \forall \vec{n} \in W^{\frac{1}{2}}(\Gamma) \\ \int_{\Gamma} \text{curl}_{\Gamma} \vec{\xi} w \, d\gamma = \langle g, w \rangle_{\Gamma} \quad \forall w \in L^2(\Gamma) \cap M(\Gamma) \end{array} \right.$$

admits a unique solution $(\vec{\xi}, \theta) \in W^{\frac{1}{2}} \times (L^2 \cap M)$ satisfying (2.21), (2.23),

$\theta \in H^{\frac{3}{2}}(\Gamma)$, and

$$(2.25) \quad \|\vec{\xi}\|_{\frac{1}{2},\Gamma} \leq C \|g\|_{-\frac{1}{2},\Gamma}$$

Moreover if $g \in H^{\frac{1}{2}}(\Gamma)$, we have $\theta \in H^{\frac{5}{2}}(\Gamma)$ and $\vec{\xi} \in TH^{\frac{3}{2}}(\Gamma)$.

PROOF OF PROPOSITION 2.7

- Following RAVIART-THOMAS [40], we clearly see that the pair $(\theta, \vec{\text{curl}}_{\Gamma} \theta)$ with $\theta \in M(\Gamma)$ solution of $-\Delta_{\Gamma} \theta = g$, is solution of (2.24) because $\langle w, \text{curl}_{\Gamma} \vec{n} \rangle_{\Gamma} = \langle \vec{\text{curl}}_{\Gamma} w, \vec{n} \rangle_{\Gamma}$ for $w \in H^{\frac{1}{2}}$ and $\vec{n} \in TH^{\frac{1}{2}}$. The uniqueness is established by linearity : if $g=0$, the second equation shows that $\text{curl}_{\Gamma} \vec{\xi} = 0$, then $\vec{\xi} = 0$ (Proposition 2.6). Furthermore, let ρ , in $H^2(\Gamma) \cap M(\Gamma)$, be the solution of $-\Delta_{\Gamma} \rho = \theta$. If we set $\vec{n} = \vec{\text{curl}}_{\Gamma} \rho$, then $\vec{n} \in W^{\frac{1}{2}}(\Gamma)$. If we use this function in the first equation of (2.24), we find $\int_{\Gamma} \theta^2 d\gamma = 0$. The estimation (2.25) is then a simple consequence of Proposition 2.6.
- The relation (2.21) holds in the sense of distributions because both $\text{curl}_{\Gamma} \vec{\xi}$ and g are equal if they are applied to functions of $L^2(\Gamma) \cap M(\Gamma)$ or to constant functions.
- If g belongs to $H^{\frac{1}{2}}(\Gamma)$, the regularity of θ is clear. ■

5) A GLOBAL RESULT

We consider a velocity field in $(H^1(\Omega))^3$ satisfying

$$(2.26) \quad \text{div } \vec{u} = 0 \quad \Omega$$

$$(2.27) \quad \int_{\Gamma_j} \vec{u} \cdot \vec{n} d\gamma = 0 \quad \text{on } \Gamma_j, \quad j=0,1,\dots,N_{\Gamma}$$

and we suppose that both $\vec{\omega}$ and g satisfy

$$(2.28) \quad \vec{\text{curl}} \vec{u} = \vec{\omega} \quad \Omega$$

$$(2.29) \quad \vec{u} \cdot \vec{n} = g \quad \Gamma$$

We propose in Proposition 2.8 a way to "compute" without ambiguity a vector potential $\vec{\psi}$ of \vec{u}

$$(2.30) \quad \vec{u} = \text{curl } \vec{\psi} \quad \Omega$$

We recall first a Theorem of J.L. Lions (right inverse of the trace operator):

THEOREM 2.8 (e.g. LIONS-MAGENES [32]) *The trace mapping γ_0 , defined by $\gamma_0 \varphi = \left(\varphi|_{\Gamma}, \frac{\partial \varphi}{\partial n}|_{\Gamma} \right)$ if φ is regular can be extended from $H^2(\Omega)$ onto $H^{\frac{3}{2}}(\Gamma) \times H^{\frac{1}{2}}(\Gamma)$ and admits a continuous inverse \mathcal{R} , from $H^{\frac{3}{2}}(\Gamma) \times H^{\frac{1}{2}}(\Gamma)$ to $H^2(\Omega)$: $H^{\frac{3}{2}}(\Gamma) \times H^{\frac{1}{2}}(\Gamma) \ni q \mapsto \mathcal{R}q \in H^2(\Omega)$*

$$\gamma_0(\mathcal{R}q) = q \quad \forall q \in H^{\frac{3}{2}} \times H^{\frac{1}{2}}$$

$$\exists C > 0, \|\mathcal{R}q\|_{2,\Omega} \leq C \|q\|_{H^{\frac{3}{2}} \times H^{\frac{1}{2}}}, \quad \forall q \in H^{\frac{3}{2}} \times H^{\frac{1}{2}}.$$

PROPOSITION 2.8 *Let \vec{u} be given in $(H^1(\Omega))^3$ by (2.26)-(2.29). There exists a continuous vector potential $\vec{\psi}$ which satisfies (2.30) and defines a continuous mapping $(H^1(\Omega))^3 \rightarrow W^2(\Omega)$ computable without any use of the harmonic functions belonging to the spaces $H_T(\Omega)$ and $H_N(\Omega)$.*

PROOF OF PROPOSITION 2.8

• Consider first the boundary equation (2.29). From Proposition 2.7 there exists some $\vec{\xi} \in TH^{\frac{3}{2}}(\Gamma)$ verifying (2.21). Each component ξ_i of $\vec{\xi}$ belongs to $H^{\frac{3}{2}}(\Gamma)$ and, by Theorem 2.8 the vector field $\vec{\zeta}$ defined on Ω by its components ζ_i , $\zeta_i = \mathcal{R}(\xi_i, 0)$ satisfies $\text{curl}_{\Gamma} \Pi \vec{\zeta} = g$ and

$$\|\vec{\zeta}\|_{2,\Omega} \leq C \|\vec{\xi}\|_{\frac{3}{2},\Gamma} \leq C \|g\|_{\frac{1}{2},\Gamma}$$

• Secondly, the mixed problem

$$\left\{ \begin{array}{l} \vec{z} \in (L^2(\Omega))^3, \quad \vec{\chi} \in W^1(\Omega) \\ \int_{\Omega} \vec{z} \cdot \vec{v} \, dx - \int_{\Omega} \text{curl} \vec{\chi} \cdot \vec{v} \, dx \quad \forall \vec{v} \in (L^2(\Omega))^3 \\ \int_{\Omega} \vec{z} \cdot \text{curl} \vec{\phi} \, dx = \int_{\Omega} (\vec{\omega} - \text{curl} \text{curl} \vec{\zeta}) \cdot \vec{\phi} \, dx \quad \forall \vec{\phi} \in W^1(\Omega) \end{array} \right.$$

admits (according to Theorem 2.5) a solution $(\vec{z}, \vec{\chi})$ satisfying $\vec{z} = \text{curl} \vec{\chi}$, $\text{curl} \vec{z} = \vec{\omega} - \text{curl}(\text{curl} \vec{\zeta})$ in Ω , $\vec{z} \cdot \vec{n} = 0$ on Γ , and $\|\vec{\chi}\|_{W^2} \leq C(\|\vec{\omega}\|_{0,\Omega} + \|\vec{\zeta}\|_{2,\Omega})$ thanks to (2.18) and Proposition 2.4. By uniqueness of \vec{z} , we have $\vec{z} = \vec{u} - \text{curl} \vec{\zeta}$ in Ω , so $\vec{\psi} = \vec{\chi} + \vec{\zeta}$ solves the problem. ■

We end this part with a general result on harmonic vector fields.

PROPOSITION 2.9 Let g be in $H^{-\frac{1}{2}}(\Gamma) \cap M(\Gamma)$. The problem

$$(2.31) \quad \left\{ \begin{array}{ll} \text{div} \vec{u} = 0 & \Omega \\ \text{curl} \vec{u} = 0 & \Omega \\ \vec{u} \cdot \vec{n} = g & \Gamma \\ P_N \vec{u} = 0 \end{array} \right.$$

has a unique solution $\vec{u} \in H(\text{div}, \Omega)$ which satisfies

$$(2.32) \quad \|\vec{u}\|_{0,\Omega} \leq C \|g\|_{-\frac{1}{2},\Gamma}$$

for some constant C independent of g .

PROOF OF PROPOSITION 2.9

• Following TEMAM [43], the auxiliary problem

$$\left\{ \begin{array}{ll} -\Delta \phi = 0 & \Omega \\ \frac{\partial \phi}{\partial n} = g & \Gamma \end{array} \right.$$

defines $\phi \in H^1(\Omega) \cap L_0^2(\Omega)$ and the continuity of $g \mapsto \phi : \|\nabla\phi\|_{0,\Omega} \leq C \|g\|_{-\frac{1}{2},\Gamma}$ is classical. If we take

$$\vec{u} = \nabla\phi$$

the existence of \vec{u} satisfying (2.31).(2.32) is established.

- Uniqueness is a direct consequence of Theorem 2.2. ■

III - VECTORIAL CURVED FINITE ELEMENTS IN \mathbb{R}^3

We have seen in the study of the continuous problem that the representation of a divergence free vector field \vec{u} by means of a vector potential $\vec{\psi}$ leads to the internal and boundary equations $\text{curl } \vec{\psi} = \vec{u}$ in Ω and $\text{curl}_\Gamma \Pi \vec{\psi} = \vec{u} \cdot \vec{n}$ on Γ . To discretize the field $\vec{\psi}$, we choose finite elements conforming in the space $H(\text{curl}, \Omega)$ such that the boundary Γ is exactly covered by the triangulation faces. We introduce here two different curved finite elements of degree 1 which are conforming in the spaces $H(\text{div}, \Omega)$ and $H(\text{curl}, \Omega)$ and are a natural generalization of NEDELEC's tetrahedrons [37]. Then we show that for \vec{v} in $H(\text{div}, \Omega)$ (resp. $\vec{\phi}$ in $W^2(\Omega)$) the interpolation error in the associated discrete space $V_h(\Omega)$ (resp. $W_h(\Omega)$) is of optimal order. We construct in the following a triangulation \mathcal{T}_h covering exactly the domain Ω . We denote by $\mathcal{F}_h|_{\partial\Omega}$ the subset of \mathcal{F}_h formed by elements K such that the intersection $K \cap \partial\Omega$ is not void.

1) DEFINITION OF CURVILINEAR TETRAHEDRONS

DEFINITION 3.1 Let \hat{K} be the "unity tetrahedron" :

$$\hat{K} = \left\{ (x_1, x_2, x_3) \in \mathbb{R}^3, x_i \geq 0, i=1,2,3, x_1 + x_2 + x_3 \leq 1 \right\}$$

A *curvilinear tetrahedron* is defined by the range of \hat{K} by a regular (class \mathcal{C}^2) one to one function F :

$$(3.1) \quad \hat{K} \ni \hat{x} \mapsto x = F(\hat{x}) \in K.$$

Practically, either K is an internal element of the triangulation and F is assumed to be a linear mapping (this hypothesis will be implicit in the following), or K has at least one point on the boundary.

In the latter, four cases can occur :

- (i) $K \cap \partial\Omega$ is an edge of the tetrahedron
- (ii) $K \cap \partial\Omega$ is a face of the tetrahedron
- (iii) $K \cap \partial\Omega$ is reduced to one point
- (iv) $K \cap \partial\Omega$ contains at least two faces of K .

In the case (iii), F is also chosen linear, and the case (iv) can be eliminated by a refinement of the mesh. We focus now on (i) and (ii) (figure 3.1).

HYPOTHESIS 3.1 We assume that the triangulation \mathcal{T}_h is sufficiently refined (i.e. h sufficiently small) to be sure that the orthogonal projection P_Γ is well defined on $\mathcal{T}_h|_{\partial\Omega}$ (Proposition 1.1).

DEFINITION 3.2

- (i) Assume that exactly two vertices A_1, A_2 of K belong to the set $\Gamma \cap \Omega_i$ defined in (1.6)-(1.8). The curved edge $\widehat{A_1 A_2}$ is defined as $P_\Gamma([A_1 A_2])$ where $[A_1 A_2]$ is the straight line between these two points.
- (ii) If $\partial\Omega$ contains three vertices A_1, A_2, A_3 of K , the curved face $\widehat{A_1 A_2 A_3}$ is exactly $P_\Gamma([A_1 A_2 A_3])$ where $[A_1 A_2 A_3]$ is the corresponding plane face.

We can now describe the choice that we are making for the curved elements K of $\mathcal{T}_h|_{\partial\Omega}$.

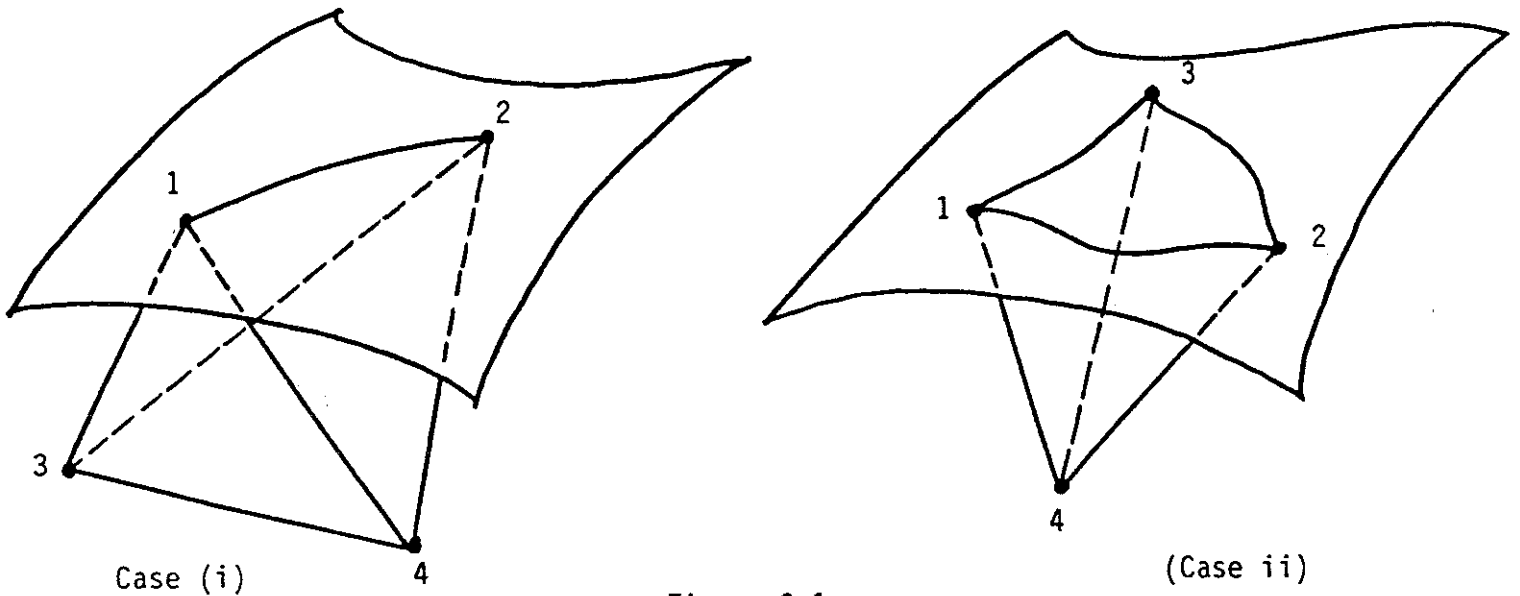

Figure 3.1

Intersection of a curvilinear tetrahedron with the boundary

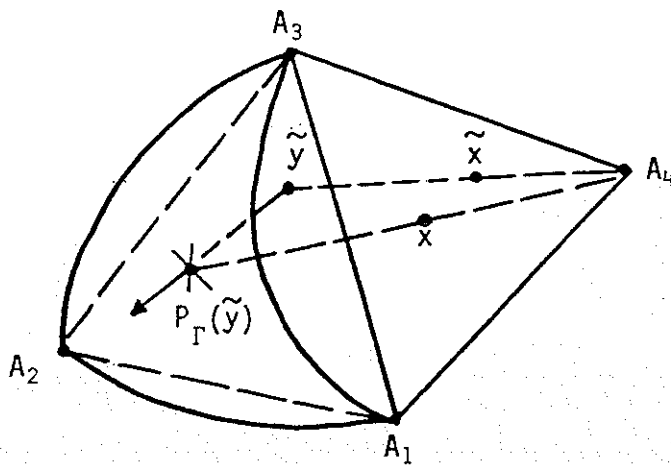

Figure 3.2

Transformation of a straight tetrahedron into a curvilinear one

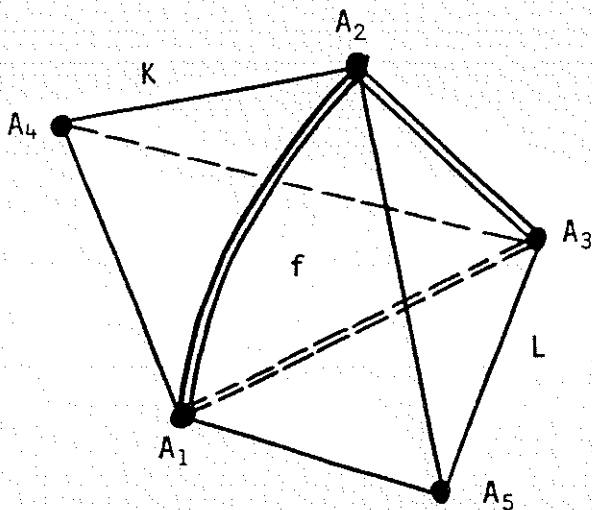

Figure 3.3

Curvilinear face (f) common to two curvilinear tetrahedrons (K,L)

DEFINITION 3.3 If \hat{x} is a point of the unity tetrahedron \hat{K} , we denote by $\lambda_j (j=1, \dots, 4)$ its barycentric coordinates.

(i) If K contains a curved edge $\widehat{A_1 A_2}$, we set

$$(3.2) \quad F(\hat{x}) = (1 - \lambda_3 - \lambda_4) P_{\Gamma} \left(\frac{\lambda_1 A_1 + \lambda_2 A_2}{\lambda_1 + \lambda_2} \right) + \lambda_3 A_3 + \lambda_4 A_4$$

(ii) If a curved face $\widehat{A_1 A_2 A_3}$ is included in $\partial\Omega$, we set

$$(3.3) \quad F(\hat{x}) = (1 - \lambda_4) P_{\Gamma} \left(\frac{\lambda_1 A_1 + \lambda_2 A_2 + \lambda_3 A_3}{\lambda_1 + \lambda_2 + \lambda_3} \right) + \lambda_4 A_4 .$$

(see figure 3.2).

This type of definition was first proposed by ZLAMAL [45,46], studied by SCOTT [42], and generalized by LENOIR [31]. Geometrically we first write a current point \tilde{x} of the straight tetrahedron $[A_1 A_2 A_3 A_4]$ as a barycentre of one point y on the edge $[A_1 A_2]$ (case (i), $p=2$) or on the face $[A_1 A_2 A_3]$ (case (ii), $p=3$) and of the other vertices of K :

$$(3.4) \quad \left\{ \begin{array}{l} \mu = 1 - \sum_{j=1}^p \lambda_j \\ \tilde{y} = \sum_{j=1}^p \frac{\lambda_j}{\mu} A_j \\ \tilde{x} = \mu \tilde{y} + \sum_{j=p+1}^4 \lambda_j A_j \end{array} \right.$$

Then we project \tilde{y} on $\partial\Omega$ without changing the barycentric coordinates relative to the set $\{y, A_{p+1}, \dots, A_4\}$:

$$(3.5) \quad x = \mu P_{\Gamma}(\tilde{y}) + \sum_{j=p+1}^4 \lambda_j A_j$$

This formula represents both (3.2) and (3.3).

PROPOSITION 3.1 *The edges and faces of the triangulation \mathcal{T}_h are defined intrinsically without any explicit reference to the element which contain them.*

PROOF OF PROPOSITION 3.1

To fix the ideas, suppose that the curvilinear elements K and L have corresponding straight tetrahedrons \tilde{K} and \tilde{L} which have one common face $\tilde{f} = [A_1 A_2 A_3]$ (figure 3.3). Then A_1, A_2, A_3 cannot be simultaneously on the boundary $\partial\Omega$ and, for example, A_1 and A_2 are on the boundary and A_3 is an internal point. If \tilde{y} belongs to $[A_1 A_2]$, its image y on $\widehat{A_1 A_2}$ is exactly $P_\Gamma(\tilde{y})$ (thanks to (3.4).(3.5)) and does not depend on K or L . And for \tilde{x} on \tilde{f} we have

$$\tilde{x} = \mu \tilde{y} + \lambda_3 A_3 + 0.A_4 + 0.A_5 .$$

and it is clear that the corresponding x by (3.5) does not depend on the choice of the referring finite element. ■

2) INTERPOLATION SPACES

We adapt in this paragraph the spaces proposed by NEDELEC [37] to discretize Sobolev spaces $H(\text{div}, \Omega)$ and $H(\text{curl}, \Omega)$.

DEFINITION 3.4 *We set*

$$D_1 = \left\{ \vec{v} : \mathbb{R}^3 \rightarrow \mathbb{R}^3, \exists \vec{\alpha} \in \mathbb{R}^3, \beta \in \mathbb{R}, \vec{v}(\vec{x}) = \vec{\alpha} + \beta \vec{x} \right\}$$

$$R_1 = \left\{ \vec{\varphi} : \mathbb{R}^3 \rightarrow \mathbb{R}^3, \exists \vec{\alpha}, \vec{\beta} \in \mathbb{R}^3, \vec{\varphi}(\vec{x}) = \vec{\alpha} + \vec{\beta} \times \vec{x} \right\}$$

and, if K is a curvilinear tetrahedron (Definition 3.3), the corresponding degrees of freedom are :

$$\Sigma_f(K) = \left\{ \sigma_f(\vec{v}) \equiv \int_f \vec{v} \cdot \vec{n} \, d\gamma, \text{ f face of } K \right\}$$

$$\Sigma_a(K) = \left\{ \sigma_a(\vec{\varphi}) \equiv \int_a \vec{\varphi} \cdot d\vec{s}, \text{ a edge of } K \right\}.$$

DEFINITION 3.5 Let K be a curvilinear tetrahedron (cf. Definition 3.3).

We denote by $dF(\hat{x})$ the tangent linear mapping of F at the point \hat{x} , and $J(\hat{x})$ its jacobian. The generalizations of D_1 and R_1 are :

$$(3.6) \quad \begin{aligned} D_1(K) &= \left\{ \vec{v} : K \rightarrow \mathbb{R}^3, \exists \hat{v} \in D_1, \forall \hat{x} \in \hat{K}, \right. \\ &\quad \left. \vec{v}(F(\hat{x})) = \frac{1}{J(\hat{x})} dF(\hat{x}) \cdot \hat{v}(\hat{x}) \right\} \end{aligned}$$

$$(3.7) \quad \begin{aligned} R_1(K) &= \left\{ \vec{\varphi} : K \rightarrow \mathbb{R}^3, \exists \hat{\varphi} \in R_1, \forall \hat{x} \in \hat{K}, \right. \\ &\quad \left. \vec{\varphi}(F(\hat{x})) = {}^t dF(\hat{x})^{-1} \cdot \hat{\varphi}(\hat{x}) \right\} \end{aligned}$$

and we will also use

$$P_1(K) = \left\{ w : K \rightarrow \mathbb{R}, \exists \hat{w} \in P_1, \forall \hat{x} \in \hat{K}, w(F(\hat{x})) = \hat{w}(\hat{x}) \right\}$$

where P_1 denotes the set of polynomials of degree not greater than 1.

PROPOSITION 3.2 If F is chosen according to Definition 3.3, the elements $(K, \Sigma_f(K), D_1(K))$ and $(K, \Sigma_a(K), R_1(K))$ are unisolvent and conforming in the spaces $H(\text{curl}, K)$ and $H(\text{div}, K)$ respectively.

PROOF OF PROPOSITION 3.2

The proof is due to NEDELEC (Theorems 1 and 3 of [37]) when F is linear (i.e. $D_1(K) \equiv D_1$ and $R_1(K) \equiv R_1$). In the general case the unisolvent property is a direct consequence of the formulae

$$(3.8) \quad \int_f \vec{v}(x) \cdot \vec{n} \, d\gamma = \int_{\hat{f}} \hat{v}(\hat{x}) \cdot \hat{n} \, d\hat{\gamma}(\hat{x})$$

$$(3.9) \quad \int_a \vec{\varphi}(x) \cdot d\vec{s}(x) = \int_{\hat{a}} \hat{\varphi}(\hat{x}) \cdot d\hat{s}(\hat{x})$$

obtained by the change of variable $x = F(\hat{x})$ and by (3.6)-(3.7), and of the previous unisolvent property. The finite element $(K, \Sigma_f(K), D_1(K))$ is conforming in $H(\text{div}, K)$ if, and only if, for each face f of K and each $\vec{v} \in D_1(K)$, $\sigma_f(\vec{v}) = 0$ implies $\vec{v} \cdot \vec{n} = 0$ on f . Due to (3.8) and the straight case, $\hat{v} \cdot \hat{n} = 0$ on \hat{f} and \hat{v} is a tangent field on \hat{f} which is transformed by dF in a tangent vector field on f , then $(dF(\hat{x}) \cdot \hat{v}, n) = 0$ on f .

The finite element $(K, \Sigma_a(K), R_1(K))$ is conforming in $H(\text{curl}, K)$ if, and only if, for each face f and each $\vec{\varphi} \in R_1(K)$, $\sigma_a(\vec{\varphi}) = 0$ (for each edge a of the boundary of f) implies $\vec{n} \times \vec{\varphi} = 0$ on f . As in the previous case, $\hat{n} \times \hat{\varphi} = 0$ on \hat{f} . Let $\hat{\tau}$ be tangent vector field on \hat{f} , then (3.7) gives $(\vec{\varphi}(x), dF \cdot \hat{\tau}(\hat{x})) = (\hat{\varphi}(\hat{x}), \hat{\tau})$ which is null because $\hat{\varphi} \times \hat{n} = 0$. Hence $\vec{\varphi} \times \vec{n} = 0$ and the property is proved. ■

3) INTERPOLATION AND ERROR ESTIMATES

We define now interpolation spaces on the domain Ω due to the triangulation \mathcal{T}_h . We assume that \mathcal{T}_h is regular, i.e.

HYPOTHESIS 3.2 *There exists a fixed constant C such that, for each $h > 0$ and each element K of \mathcal{T}_h , we have the following inequalities between the diameter $h(K)$ of K , the radius $\rho(K)$ of the largest inscribed sphere in K , and h :*

$$h(K) \leq h \leq C h(K) \quad , \quad h(K) \leq C \rho(K) \quad .$$

DEFINITION 3.6

$$\begin{aligned}
V_h(\Omega) &= \left\{ \vec{v} \in H(\text{div}, \Omega) , \forall K \in \mathcal{T}_h , \vec{v}|_K \in D_1(K) \right\} \\
V_h^0(\Omega) &= \left\{ \vec{v} \in V_h(\Omega) , \vec{v} \cdot \vec{n} = 0 \text{ on } \partial\Omega \right\} \\
W_h(\Omega) &= \left\{ \vec{\varphi} \in H(\text{curl}, \Omega) , \forall K \in \mathcal{T}_h , \vec{\varphi}|_K \in R_1(K) \right\} \\
W_h^0(\Omega) &= \left\{ \vec{\varphi} \in W_h(\Omega) , \vec{\varphi} \times \vec{n} = 0 \text{ on } \partial\Omega \right\}
\end{aligned}$$

The corresponding degrees of freedom are

$$\begin{aligned}
\Sigma_f(\Omega) &= \left\{ \sigma_f(\vec{v}) = \int_f \vec{v} \cdot \vec{n} \, d\gamma , f \text{ face of } \mathcal{T}_h \right\} \\
\Sigma_a(\Omega) &= \left\{ \sigma_a(\vec{\varphi}) = \int_a \vec{\varphi} \cdot d\vec{s} , a \text{ edge of } \mathcal{T}_h \right\} .
\end{aligned}$$

We recall also the definition of scalar valued functions on curved finite elements which extends in a straightforward way the usual P_1 finite element (e.g. CIARLET [14]).

DEFINITION 3.7

$$\begin{aligned}
H_h^1(\Omega) &= \left\{ w \in H^1(\Omega) , \forall K \in \mathcal{T}_h , w|_K \in P_1(K) \right\} \\
H_{oh}^1(\Omega) &= H_h^1(\Omega) \cap H_0^1(\Omega)
\end{aligned}$$

The associated degrees of freedom are the values $w(p)$ for p vertex of the mesh \mathcal{T}_h . We notice that the latter definition remains unchanged if Ω is a twodimensional domain.

THEOREM 3.1 We assume that \mathcal{T}_h satisfies hypothesis 3.1-3.2. For \vec{v} in $(H^1(\Omega))^3$ there is one and only one interpolation vector $\Pi_h^D \vec{v}$ in $V_h(\Omega)$ defined by

$$(3.10) \quad \sigma_f(\Pi_h^D \vec{v}) = \sigma_f(\vec{v}) \quad \forall f \text{ face of } \mathcal{T}_h$$

and we have

$$(3.11) \quad \|\vec{v} - \Pi_h^D \vec{v}\|_{0,\Omega} \leq C h \|\vec{v}\|_{1,\Omega}$$

for some constant C .

THEOREM 3.2 Under the same hypothesis on \mathcal{F}_h , for $\vec{\phi}$ in $W^2(\Omega)$ there is a unique interpolation vector $\Pi_h^R \vec{\phi}$ in $W_h(\Omega)$ satisfying

$$(3.12) \quad \sigma_a(\Pi_h^R \vec{\phi}) = \sigma_a(\vec{\phi}) \quad \forall a \text{ edge of } \mathcal{F}_h$$

We have also

$$(3.13) \quad \|\vec{\phi} - \Pi_h^R \vec{\phi}\|_{H(\text{curl}, \Omega)} \leq C h \|\vec{\phi}\|_{W^2(\Omega)}.$$

The proof of these theorems needs a precise analysis of the way we approximate functions in elements adjacent to the boundary. First some auxiliary results. We follow NEDELEC [35]. We recall (c.f. Part I) that the local charts $\mu_i: \Omega_i \rightarrow]-1, 1[^3$ ($i = 1, \dots, p$) have a restriction to $\partial\Omega \cap \Omega_i$ which satisfies

$$\mu_i(\partial\Omega \cap \Omega_i) =]-1, 1[^2 \times (0)$$

Moreover it is possible to find polygonal subsets D_i of $]-1, 1[^2 \times (0)$ which are compatible with the triangulation \mathcal{F}_h : the parts $\tilde{\Gamma}_i = \mu_i^{-1}(D_i)$ of the boundary are recovered exactly by curvilinear triangles of \mathcal{F}_h lying on $\partial\Omega$ and $\bigcup_{i=1}^p \tilde{\Gamma}_i = \Gamma$. The inverse function of $\mu_i|_{D_i}$ is denoted by ϕ_i :

$$D_i \ni \xi \mapsto \phi_i(\xi) \in \tilde{\Gamma}_i$$

which is an exact parameterization of $\tilde{\Gamma}_i$.

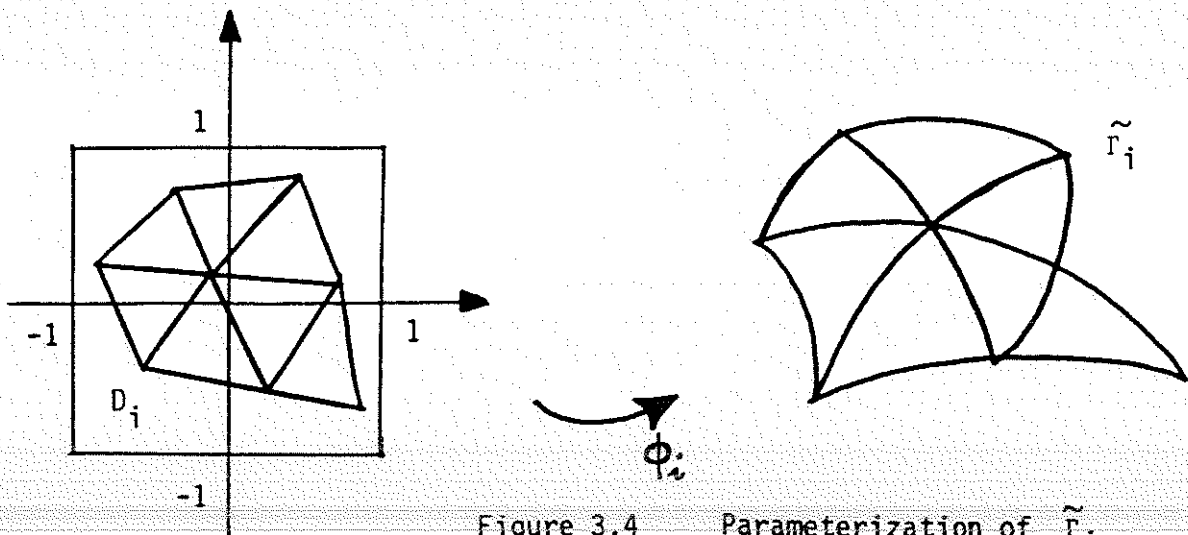

Figure 3.4 Parameterization of $\tilde{\Gamma}_i$

In practice, each polygonal set D_i is obtained as follows: the vertices of T_h lying on Γ_i define a set of points in $] -1, 1[\times (0)$ according to the local charts μ_i . Then a plane triangulation T_{ih} having those points as vertices is defined naturally inside $(] -1, 1[)^2 \times (0)$, due to the topology of the curvilinear triangulation $T_h \cap \Gamma_i$. The union of the corresponding triangles form the subsets D_i (Figure 3.4). Moreover let ϕ_{ih} be the unique continuous mapping which is affine in each triangle of T_{ih} and coincides with ϕ_i at the vertices of T_{ih} (ϕ_{ih} is exactly the P_1 interpolate of ϕ_i , c.f. Definition 3.7) :

$$D_i \ni \xi \rightarrow \phi_{ih}(\xi) \in (H_h^1(D_i))^3$$

$$\phi_{ih}(p) = \phi_i(p) \quad \forall p \text{ vertex of } T_{ih}.$$

The range of ϕ_{ih} is denoted by $\tilde{\Gamma}_{ih}$ and is exactly the union of the straight triangles that T_h defines on $\tilde{\Gamma}_i$. Thus we have two different parameterizations of the surface $\tilde{\Gamma}_i$ (that we compare at the proposition 3.3): on one hand the chart $\phi_i: D_i \rightarrow \tilde{\Gamma}_i$ and on the other hand the composite $P_{\tilde{\Gamma}_i} \circ \phi_{ih}$ of $\phi_{ih}: D_i \rightarrow \tilde{\Gamma}_{ih}$ and $P_{\tilde{\Gamma}_i}$ (restricted to $\tilde{\Gamma}_{ih}$). First we have the following property:

LEMMA 3.1 Let A_1, A_2, A_3 be three vertices of \mathcal{F}_h lying on a piece $\tilde{\Gamma}_j$ of the boundary, and $\tilde{y} = \sum_{i=1}^3 \lambda_i A_i$ a point of the straight triangle $[A_1 A_2 A_3]$. We can define a unique point $\xi(\tilde{y})$ in D_j such that

$$(3.14) \quad \phi_{ih}(\xi(\tilde{y})) \equiv \tilde{y} .$$

PROOF

$$\xi(\tilde{y}) = \sum_{i=1}^3 \lambda_i \phi_i(A_i) .$$

We specify now the relations between the exact surface $\tilde{\Gamma}_j$, the approximate $\tilde{\Gamma}_{jh}$, and the normal projection P_Γ on the boundary $\partial\Omega$.

PROPOSITION 3.3 (NEDELEC [34]) Under hypotheses 3.1 and 3.2, we have

$$(3.15) \quad \sup_{\xi \in D_j} |D^\alpha \phi_j(\xi) - D^\alpha \phi_{jh}(\xi)| \leq C h^{2-\alpha} \sup_{\xi \in D_j} |D^2 \phi_j(\xi)| \quad \alpha = 0, 1 .$$

$$(3.16) \quad \begin{aligned} & \sup_{k \in \mathcal{F}_{jh}} \sup_{\xi \in k} |D^\alpha (P_\Gamma \circ \phi_{jh})(\xi) - D^\alpha \phi_{jh}(\xi)| \leq \\ & \leq C h^{2-\alpha} \sup_{i=1, \dots, p} \sup_{\xi \in D_j} |D^2 \phi_j(\xi)| , \quad \alpha = 0, 1, 2 . \end{aligned}$$

LEMMA 3.2 Let K be a curvilinear tetrahedron of \mathcal{F}_h , and \tilde{K} be the associated straight tetrahedron. The map F (Definition 3.3) is the composite

$$(3.17) \quad F = \tilde{F}_0(\hat{x} \mapsto B\hat{x} + b)$$

with $\hat{K} \ni \hat{x} \mapsto \tilde{x} = B\hat{x} + b \in \tilde{K}$ and $\tilde{K} \ni \tilde{x} \mapsto x = \tilde{F}(\tilde{x}) \in K$. Under the hypotheses 3.1 and 3.2, we have :

$$(3.18) \quad \sup_{\tilde{x} \in \tilde{K}} |dF_{ij}(x) - \delta_{ij}| \leq Ch \quad ; \quad i, j = 1, 2, 3.$$

$$(3.19) \quad \sup_{\tilde{x} \in \tilde{K}} \left| \frac{\partial}{\partial \tilde{x}_k} d\tilde{F}_{ij}(\tilde{x}) \right| \leq C \quad ; \quad i, j, k = 1, 2, 3.$$

for some constant C independent of K and h ; δ_{ij} is the Kronecker matrix.

PROOF OF LEMMA 3.2

Due to (3.4). (3.5) and (3.14) we have :

$$(3.20) \quad \tilde{F}(\tilde{x}) = \tilde{x} + \mu(\tilde{x})(P_\Gamma \circ \phi_{ih} - \phi_{ih})(\xi(\tilde{x}))$$

with $\mu(\tilde{x})$ defined in (3.4).

• We first prove (3.18). By differentiation of (3.20), we have to control both

$$(3.21) \quad \frac{\partial \mu(\tilde{x})}{\partial \tilde{x}_j} (P_\Gamma \circ \phi_{ih} - \phi_{ih})(\xi(\tilde{x}))$$

and

$$(3.22) \quad \mu(\tilde{x}) \frac{\partial}{\partial \xi_k} (P_\Gamma \circ \phi_{ih} - \phi_{ih}) \frac{\partial \xi_k}{\partial \tilde{x}_j}$$

On one hand, it is classical that $\left| \frac{\partial \lambda_l}{\partial \tilde{x}_j} \right| \leq \frac{1}{2\rho}$ with ρ radius of the inscribed sphere in \tilde{K} .

Then according to hypothesis 3.2, we have

$$(3.23) \quad \left| \frac{\partial \mu}{\partial \tilde{x}_j} \right| \leq \frac{C}{h}$$

Moreover (3.16) with $\alpha = 0$ and the hypothesis 3.2 prove that the expression (3.21) is bounded by Ch . On the other hand, let A_0 be the center of gravity of the simplex $[A_1 \dots A_p]$; then from (3.14) we have

$$\phi_{ih}(\xi(\tilde{x})) = \sum_{j=1}^p A_0 \vec{A}_j \frac{\lambda_j}{\mu(\tilde{x})}$$

$\frac{\lambda_j}{\mu(\tilde{x})}$ is a particular barycentric coordinate in $[A_1 \dots A_p]$. Then (3.23) is valid with μ replaced by $\frac{\lambda_j}{\mu}$. Moreover the gradient of ϕ_{ih} is bounded from below by some constant γ , because ϕ_i is a \mathcal{C}^1 -diffeomorphism and the error $(\phi_{ih} - \phi_i)$ tends to zero in \mathcal{C}^1 -norm due to (3.15). We deduce

$$\left| \frac{\partial \xi}{\partial \tilde{x}_j} \right| \leq \frac{1}{\gamma} p h \frac{C}{h} \leq C$$

This inequality joined with (3.16) (case $\alpha = 1$) shows that (3.22) is also bounded by some Ch . So (3.18) holds.

- The proof of (3.19) is similar. ■

PROOF OF THEOREM 3.1

Since (3.11) is additive, it is sufficient to prove it locally in one element K . Let $\vec{v} \in (H^1(K))^3$ and $\Pi \vec{v}$ its interpolate in $V_h(\Omega)$: $\sigma_f(\vec{v}) = \sigma_f(\Pi \vec{v})$ for f face of K . Due to (3.6) we define $\hat{v} \in (H^1(\hat{K}))^3$ and $\hat{\Pi} v \in D_1$. If we denote by $\hat{\Pi}$ the interpolation operator conforming in $H(\text{div}, \hat{K})$, we have $\hat{\Pi} v = \hat{\Pi} \hat{v}$ because those two functions of D_1 have the same degrees of freedom (cf. Proposition 3.2). We compute then easily by changing variables: $K \ni x \mapsto \hat{x} \in \hat{K}$:

$$\int_K |\vec{v} - \Pi \vec{v}|^2 dx \leq \sup_{\hat{x} \in \hat{K}} \left| \frac{1}{J(\hat{x})} \|dF(\hat{x})\|_2^2 \right| \cdot \int_{\hat{K}} |\hat{v} - \hat{\Pi} \hat{v}|^2 d\hat{x}$$

(The norm $\|dF(\hat{x})\|_2$ of the operator $dF(\hat{x})$ is equal to the operator l^2 norm in \mathbb{R}^3). The factorization (3.17) of F and the estimates (3.18) on $\tilde{dF}(\tilde{x})$ show that there exists some constant C independent of K and h such that

$$(3.24) \quad \int_K |\vec{v} - \Pi\vec{v}|^2 dx \leq \frac{C}{|\det B|} \|B\|^2 \int_K |\hat{v} - \hat{\Pi}\hat{v}|^2 d\hat{x}$$

Thus from the Bramble-Hilbert lemma [10] and from the inclusion $(P_0(K))^3 \subset D_1(\hat{K})$ it follows :

$$(3.25) \quad \int_{\hat{K}} |\hat{v} - \hat{\Pi}\hat{v}|^2 d\hat{x} \leq C |\hat{v}|_{1,K}^2$$

with $|\hat{v}|_{1,K}^2 = \int_{\hat{K}} \sup_{|\xi| \leq 1, |\eta| \leq 1} (\hat{n}, d\hat{v}(\hat{x}) \cdot \hat{\xi})^2 d\hat{x}$.

We have, after resolution and derivation of (3.6) :

$$(3.26) \quad \begin{aligned} (\hat{n}, d\hat{v}(\hat{x}) \cdot \hat{\xi}) &= J(\hat{x}) ({}^t dF^{-1}(x) \cdot \hat{n}, dv(x) \cdot dF(\hat{x}) \cdot \hat{\xi}) + \\ &+ \sum_{i,j,k} \frac{\partial}{\partial \hat{x}_j} (J(\hat{x}) dF_{ik}^{-1}(\hat{x})) v_k(x) \hat{\xi}_j \hat{n}_i \end{aligned}$$

The square of the first term, due to (3.18) has after integration, the following upper bound :

$$(3.27) \quad C |\det B| \|B^{-1}\|_2^2 \|B\|_2^2 |\vec{v}|_{1,K}^2$$

and the second term of (3.26) can be rewritten as :

$$(3.28) \quad (\det B) \sum_{i,j,k,l,m} B_{il}^{-1} B_{mj} \frac{\partial}{\partial \tilde{x}_m} (\det d\tilde{F}(\tilde{x}) d\tilde{F}_{lk}^{-1}) v_k(x) \hat{\xi}_j \hat{n}_i$$

The expression $(\det d\tilde{F}(\tilde{x}) d\tilde{F}_{lk}^{-1})$ is exactly the cofactor of the element (l,k) of the matrix $d\tilde{F}(\tilde{x})$ thus is polynomial of degree 2 in the variables $d\tilde{F}_{\alpha\beta}(\tilde{x})$ ($\alpha, \beta = 1, 2, 3$). When we differentiate it relatively to \tilde{x}_m , the derivatives

$\frac{\partial}{\partial \tilde{x}_m} d\tilde{F}_{\alpha\beta}(\tilde{x})$ are bounded due to (3.19) and the factors $d\tilde{F}_{\alpha\beta}(\tilde{x})$ are also uniformly bounded (cf. (3.18)). So the integral on \hat{K} of the square of (3.28) is bounded by

$$(3.29) \quad C |\det B| \int_{\hat{K}} |t_{B^{-1}}^{\wedge n}|^2 |B\xi|^2 |\vec{v}(x)|^2 \det B \, d\hat{x} \\ < C |\det B| \|B^{-1}\|_2 \|B\|_2^2 \|\vec{v}\|_{0,K}^2$$

Now from (3.25)-(3.27) and (3.29) we get

$$\int_{\hat{K}} |\hat{v} - \hat{\Pi}\vec{v}|^2 \, d\hat{x} \leq C |\det B| \|B\|_2^2 \|B^{-1}\|_2^2 \|\vec{v}\|_{1,K}^2$$

This last inequality combined with (3.24) and with the classical relations between the norms of B , B^{-1} and the real parameters $h(\tilde{K})$, $\rho(\tilde{K})$ (e.g. CIARLET [14]) gives $\int_K |\vec{v} - \Pi\vec{v}|^2 \, dx \leq C h^2 \|\vec{v}\|_{1,K}^2$. ■

To establish Theorem 3.2 we need two lemmas, one algebraical and one analytical.

LEMMA 3.3 (NEDELEC [37], Lemma 7). *If $\vec{\varphi} \in (P_1)^3$ satisfies $\sigma_a(\vec{\varphi}) = 0$ for each edge a of \hat{K} , then $\text{curl } \vec{\varphi} = 0$.*

LEMMA 3.4 *If Ω is connected, the norm*

$$[\vec{\varphi}] = \left\{ \left(\int_{\Omega} \vec{\varphi} \, dx \right)^2 + \left(\int_{\Omega} \nabla \vec{\varphi} \, dx \right)^2 + \int_{\Omega} \sum_j |\partial_j (\text{curl } \vec{\varphi})|^2 \, dx \right\}^{\frac{1}{2}}$$

is equivalent to the usual norm on $W^2(\Omega)$:

$$\|\vec{\varphi}\|_{W^2(\Omega)} = \left(\|\vec{\varphi}\|_{1,\Omega}^2 + \|\text{curl } \vec{\varphi}\|_{1,\Omega}^2 \right)^{\frac{1}{2}} .$$

PROOF Elementary consequence of the compactness of the inclusion $H^1 \hookrightarrow L^2$. ■

PROOF OF THEOREM 3.2

• The existence of the interpolate function $\Pi_h^R \vec{\varphi}$ is not straightforward if $\vec{\varphi}$ belongs to $W^2(\Omega)$. We verify that the integral $\sigma_a(\vec{\varphi}) = \int_a \vec{\varphi} \cdot \vec{\tau} \, ds$ can be defined : the edge a is included in a face f of the triangulation \mathcal{T}_h (whose normal is denoted by \vec{n}). Then the tangential component $\Pi \vec{\varphi}$ on f belongs to $TH^{\frac{1}{2}}(f)$ (because $\vec{\varphi} \in (H^1(\Omega))^3$), so

$$(3.30) \quad \Pi \vec{\varphi} \in (L^2(f))^2$$

The same argument shows that $\text{curl} \vec{\varphi} \cdot \vec{n} \in L^2(f)$ but we have (Lemma 2.1) $\text{curl}_\Gamma \Pi \vec{\varphi} = \text{curl} \vec{\varphi} \cdot \vec{n}$ and $\text{div}_\Gamma \Pi \vec{\varphi} = \text{curl}(\vec{n} \times \vec{\varphi}) \cdot \vec{n}$. Then, thanks to Theorem 2.7, we have :

$$(3.31) \quad \nabla_\Gamma(\Pi \vec{\varphi}) \in (L^2(f))^4$$

The inclusions (3.30) and (3.31) are equivalent to $\Pi \vec{\varphi} \in (H^1(f))^2$ which leads to $\vec{\varphi} \cdot \vec{\tau} \in H^{\frac{1}{2}}(a)$. This argument does not depend on the choice of the face f , because it is true in the case of regular vector fields.

• We estimate now $\|\vec{\varphi} - \Pi_h^R \vec{\varphi}\|_{H(\text{curl}, \Omega)}$. The inequality

$$\|\vec{\varphi} - \Pi_h^R \vec{\varphi}\|_{0, \Omega} \leq C h \|\vec{\varphi}\|_{1, \Omega}$$

can be derived from the proof of Theorem 3.1. The inequality

$$(3.32) \quad \|\text{curl}(\vec{\varphi} - \Pi \vec{\varphi})\|_{0, K} \leq C h \|\vec{\varphi}\|_{W^2(K)}$$

(with $\Pi \equiv \Pi_h^R$) is what is needed to end the proof. We denote by $\hat{\varphi}$ the element of $H(\text{curl}, \hat{K})$ associated with $\vec{\varphi}$ due to (3.14), and $\hat{\Pi} \hat{\varphi} = \hat{\Pi} \varphi$

its interpolate in R_1 . We also have from (3.14) the equality :

$$(3.33) \quad \partial_i \varphi_j - \partial_j \varphi_i = \sum_{k,1} dF_{ki}^{-1} \left(\frac{\partial \hat{\varphi}_1}{\partial \hat{x}_k} - \frac{\partial \hat{\varphi}_k}{\partial \hat{x}_1} \right) dF_{1j}^{-1}$$

from which we deduce (with help of (3.17).(3.18)) :

$$(3.34) \quad \int_K |\text{curl}(\vec{\varphi} - \Pi\vec{\varphi})|^2 dx \leq C \|B^{-1}\|_2^4 |\det B| \int_K |\text{curl}(\hat{\varphi} - \hat{\Pi}\hat{\varphi})|^2 d\hat{x}$$

Given $\hat{\chi}$ in $(L^2(\hat{K}))^3$, the linear form

$$(3.35) \quad W^2(\hat{K}) \ni \hat{\varphi} \mapsto \int_{\hat{K}} \text{curl}(\hat{\varphi} - \hat{\Pi}\hat{\varphi}) \cdot \hat{\chi} d\hat{x} \in \mathbb{R}$$

is continuous and equal to zero when $\hat{\varphi} \in (P_1)^3$ according to Lemma 3.3.

So (3.35) is continuous on the quotient space $W^2(K)/(P_1)^3$. Moreover, Lemma 3.4 implies that the semi-norm $|\text{curl} \hat{\varphi}|_{1,K}$ is norm equivalent to the quotient-norm on $W^2/(P_1)^3$. Thus we have :

$$\left| \int_{\hat{K}} \text{curl}(\hat{\varphi} - \hat{\Pi}\hat{\varphi}) \cdot \hat{\chi} d\hat{x} \right| \leq C \|\hat{\chi}\|_{0,\hat{K}} |\text{curl} \hat{\varphi}|_{1,\hat{K}}$$

which gives by duality

$$(3.36) \quad \int_{\hat{K}} |\text{curl}(\hat{\varphi} - \hat{\Pi}\hat{\varphi})|^2 d\hat{x} \leq C |\text{curl} \hat{\varphi}|_{1,\hat{K}}^2$$

The end of the proof is then similar to the end of the one in Theorem 3.1.

We have clearly :

$$(3.37) \quad \int_K \left| \frac{\partial}{\partial x_j} \left(\frac{\partial \hat{\varphi}_k}{\partial \hat{x}_1} - \frac{\partial \hat{\varphi}_1}{\partial \hat{x}_k} \right) \right|^2 dx \leq C \frac{\|B\|_2^6}{|\det B|} \int_K |\nabla(\text{curl} \vec{\varphi})|^2 dx$$

and (3.32) is a direct consequence of (3.34), (3.36) and (3.37). ■

We end this part with a useful property which is a straightforward Corollary to Theorem 3.1:

PROPOSITION 3.4 Let $\vec{v} \in H(\text{div}, \Omega)$ and $\Pi_h^D \vec{v}$ its interpolate in $V_h(\Omega)$. We have $\int_K \text{div} \vec{v} dx = \int_K \text{div} \Pi_h^D \vec{v} dx$ for each element K of \mathcal{T}_h .

IV - APPROXIMATION OF THE HOMOGENEOUS PROBLEM

We study in this part the approximation of a divergence-free vector field \vec{u} defined on a simply connected domain Ω which satisfies a homogeneous condition for its normal component on the boundary. More precisely, \vec{u} is solution of

$$(4.1) \quad \operatorname{div} \vec{u} = 0 \quad \Omega$$

$$(4.2) \quad \operatorname{curl} \vec{u} = \vec{\omega} \quad \Omega$$

$$(4.3) \quad \vec{u} \cdot \vec{n} = 0 \quad \Gamma$$

and we search an approximation \vec{u}_h of \vec{u} of the form :

$$(4.4) \quad \vec{u}_h = \operatorname{curl} \vec{\psi}_h$$

with \vec{u}_h (resp. $\vec{\psi}_h$) lying in $V_h(\Omega)$ (resp. $W_h(\Omega)$) [Definition 3.6]. In fact the uniqueness of the potential $\vec{\psi}_h$ will be assumed only if we add some discrete constraints on the space $W_h(\Omega)$. First the equation (4.3) is automatically satisfied if we choose $\vec{\psi}_h \in W_h^0(\Omega)$. Secondly, a gauge condition is necessary ; remind that in the continuous problem, we imposed the Coulomb gauge (cf. Theorem 2.5) : $\operatorname{div} \vec{\psi} = 0$. In [38], J.C. Nedelec proposed to take the weak form

$$(4.5) \quad \vec{\psi}_h \in \left\{ \vec{\psi} \in W_h^0(\Omega), \int_{\Omega} \vec{\psi} \cdot \vec{\nabla} \theta_h \, dx = 0, \forall \theta_h \in H_{0h}^1(\Omega) \right\} .$$

The Definition (4.5) gives good theoretical results but an explicit basis of the corresponding linear space is not natural. In the following a linear space for the choice of $\vec{\psi}_h$ is proposed : we treat the gauge condition in an entirely algebraical way and obtain the axial gauge (GLIMM [27]).

Then the representation (4.4) leads to a mixed discrete formulation of the problem (4.1)-(4.3) ; moreover we obtain a velocity field \vec{u}_h satisfying

$$\|\vec{u} - \vec{u}_h\|_{0,\Omega} < C h \|\vec{\omega}\|_{0,\Omega} .$$

This estimation is optimal because $\vec{\psi}_h$ is polynomial of degree 1 (out of the part $\mathcal{F}_h|_{\partial\Omega}$ near the boundary) so, following (4.4), \vec{u}_h is constant in each finite element.

1) DEFINITION OF THE DISCRETE GAUGE

We suppose that Ω is simply connected, i.e. $N_H = 0$ (figure 4.1). We assume both that the mesh \mathcal{E}_h satisfies the hypotheses 3.1 and 3.2 and :

HYPOTHESIS 4.1 The mesh \mathcal{E}_h is sufficiently refined in order that $\mathcal{E}_h|_{\partial\Omega}$ admits the partition

$$\mathcal{E}_h|_{\partial\Omega} = \bigcup_{i=1}^{N_\Gamma} \mathcal{E}_h|_{\Gamma_i} , \quad \mathcal{E}_h|_{\Gamma_i} \cap \mathcal{E}_h|_{\Gamma_j} = \emptyset \quad \text{with } \mathcal{E}_h|_{\Gamma_i}$$

formed by the elements K of $\mathcal{E}_h|_{\partial\Omega}$ such that $K \cap \Gamma_i$ is not void.

DEFINITION 4.1 If \mathcal{E}_h satisfies Hypothesis 4.1, we denote by N_e (resp. N_f, N_a, N_s) the number of elements (resp. faces, edges, vertices) of \mathcal{E}_h . The part $\mathcal{E}_h|_{\Gamma_i}$ of \mathcal{E}_h admits, for $i=0,1,\dots,N_\Gamma$, n_{fi} (resp. n_{ai}, n_{si}) faces (resp. edges, vertices) lying on the component Γ_i of Γ . Finally, we note $N_f^* = N_f - \sum_{i=0}^{N_\Gamma} n_{fi}$, $N_a^* = N_a - \sum_{i=0}^{N_\Gamma} n_{ai}$, $N_s^* = N_s - \sum_{i=0}^{N_\Gamma} n_{si}$.

We have the Euler-Poincaré relations on the manifolds Ω and Γ_i .

THEOREM 4.1 (Euler-Poincaré)

$$(4.6) \quad \chi(\Omega) \equiv N_s - N_a + N_f - N_e = N_\Gamma + 1$$

$$(4.7) \quad \chi(\Gamma_i) \equiv n_{s_i} - n_{a_i} + n_{f_i} = 2 \quad i = 0, 1, \dots, N_\Gamma \quad .$$

PROOF OF THEOREM 4.1

The domain Ω is simply connected thus for each component of its boundary (4.7) holds (e.g. MASSEY [33]). Moreover each Γ_i is the boundary of some domain whose Euler characteristic is equal to 1. So we have by additivity of the Euler-Poincaré characteristics :

$$\chi(\Omega) + \left(\sum_{i=1}^{N_\Gamma} 1 \right) - \sum_{i=1}^{N_\Gamma} \chi(\Gamma_i) = 1. \quad \blacksquare$$

To construct the discrete space of the vector potential, we need some details on the graph defined in the set of vertices of \mathcal{T}_h by the edges of the mesh. For a general reference on graph theory, we refer to BERGE [8].

DEFINITION 4.2 Let $P_h(\Omega)$ (resp. $P_h(\Gamma_i)$, $P_h(\Gamma)$, $P_h(\overset{\circ}{\Omega})$) be the set of all the vertices of the triangulation \mathcal{T}_h (resp. lying on Γ_i , lying on Γ , internal to the domain) and $A_h(\Omega)$ (resp. $A_h(\Gamma_i)$, $A_h(\Gamma)$, $A_h(\overset{\circ}{\Omega})$) the graph defined on $P_h(\Omega)$ (resp. $P_h(\Gamma_i)$, $P_h(\Gamma)$, $P_h(\overset{\circ}{\Omega})$) by the binary relation

$$\left\{ \begin{array}{l} \forall p, q \text{ vertices of } \mathcal{T}_h \text{ in } \bar{\Omega} \text{ (resp. } \Gamma_i, \Gamma, \overset{\circ}{\Omega}) \\ (p, q) \in A_h(\Omega) \text{ (resp. } A_h(\Gamma_i), A_h(\Gamma), A_h(\overset{\circ}{\Omega})) \text{ if and only if} \\ [p, q] \text{ is an edge of } \mathcal{T}_h \end{array} \right.$$

We identify in the following the sets A_h and the corresponding edges of the triangulation \mathcal{T}_h .

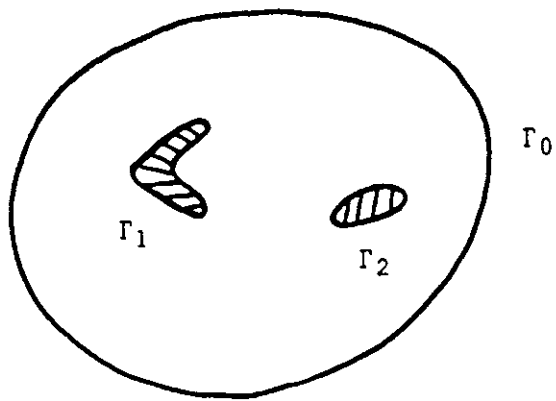

Figure 4.1 $N_{\Gamma} = 2$, $N_H = 0$

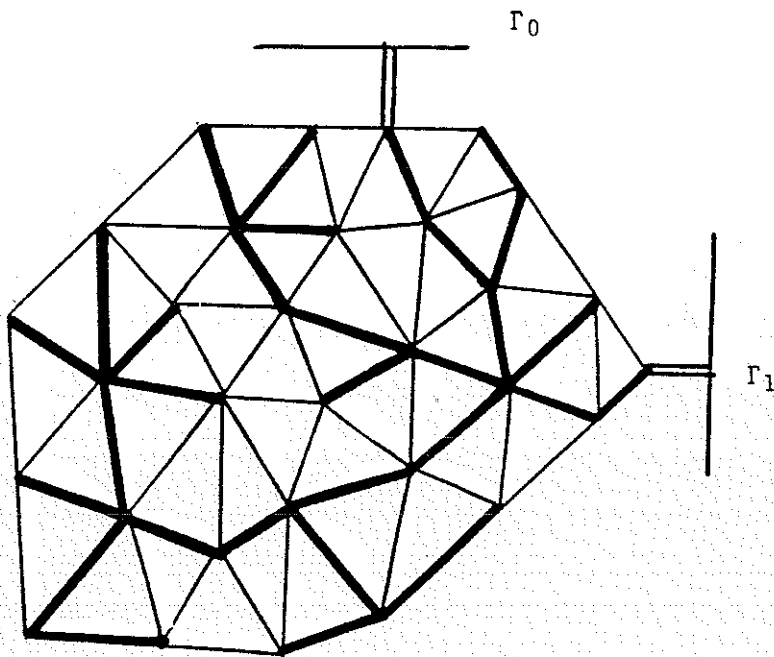

Figure 4.2 Symbolic representation of the graph $A_h(\hat{\Omega})$, the tree $T_h(\hat{\Omega})$ (thick lines) and the isolated edges of $T(\Gamma)$ (double lines)

DEFINITION 4.3 The natural basis of the space $W_h(\Omega)$ is denoted by $\vec{\phi}_a$, $a \in A_h(\Omega)$, it satisfies $\sigma_a(\vec{\phi}_b) = \delta_{a,b}$ for $a, b \in A_h(\Omega)$ and σ_a introduced in Definition 3.6.

PROPOSITION 4.1 We have

$$W_h^0(\Omega) = \text{span} \langle \vec{\phi}_a, a \in (A_h(\Omega) \setminus A_h(\Gamma)) \rangle$$

$$\dim W_h^0(\Omega) = N_a^* \quad , \quad \text{Card}(P_h(\overset{\circ}{\Omega})) = N_s^* .$$

DEFINITION 4.4 Let us fix a maximal tree $T_h(\overset{\circ}{\Omega})$ in the graph $A_h(\overset{\circ}{\Omega})$ ($T_h(\overset{\circ}{\Omega})$ is connected without cycle, admits $(N_s^* - 1)$ edges, if we cut out an edge of $T_h(\overset{\circ}{\Omega})$ it is no more connected, if we add an edge of $A_h(\overset{\circ}{\Omega}) \setminus T_h(\overset{\circ}{\Omega})$ to $T_h(\overset{\circ}{\Omega})$ we obtain a unique cycle). Let us also fix $(N_\Gamma + 1)$ edges $T(\Gamma)$ of $A_h(\Gamma)$ connecting $P_h(\overset{\circ}{\Omega})$ to each $P_h(\Gamma_i)$ for $i = 0, \dots, N_\Gamma$ (cf. figure 4.2). We set $T_h(\Omega) = T_h(\overset{\circ}{\Omega}) \cup T(\Gamma)$.

PROPOSITION 4.2 Let α be an edge of \mathcal{E}_h which does not belong to $A_h(\Gamma) \cup T_h(\Omega)$. The union $A_h(\Gamma) \cup T_h(\Omega) \cup \{\alpha\}$ contains a unique cycle, which is the boundary of a surface of \mathcal{E}_h .

PROOF OF PROPOSITION 4.2

Two cases are possible. First $\alpha \in A_h(\overset{\circ}{\Omega})$, then the cycle exists because $T_h(\overset{\circ}{\Omega})$ is a maximal tree in $A_h(\overset{\circ}{\Omega})$. Secondly $\alpha \in A_h(\Omega) \setminus A_h(\overset{\circ}{\Omega})$ i.e. α connects a point of $P_h(\Gamma_i)$ to a point p of $P_h(\overset{\circ}{\Omega})$: we denote by q the point of $P_h(\overset{\circ}{\Omega})$ connected to $P_h(\Gamma_i)$ according to $a_i \in T(\Gamma)$ and consider the path γ included in $T_h(\overset{\circ}{\Omega})$ joining p to q . Then $\{\alpha\} \cup \gamma \cup \{a_i\}$ connects two vertices of Γ_i and is easily extended by edges of $A_h(\Gamma_i)$ to define a cycle as proposed. ■

We define now the discretization $K_h(\Omega)$ of $H^0(\text{curl}, \Omega)$ satisfying the discrete axial gauge :

DEFINITION 4.5 We set

$$\begin{aligned} K_h(\Omega) &= \left\{ \vec{\varphi} \in W_h^0(\Omega), \sigma_b(\vec{\varphi}) = 0 \text{ if } b \in T_h(\Omega) \right\} \\ &= \text{span} \langle \vec{\varphi}_a, a \in A_h(\Omega) \setminus (A_h(\Gamma) \cup T_h(\Omega)) \rangle . \end{aligned}$$

DEFINITION 4.6

$$\begin{aligned} U_h(\Omega) &= \left\{ \vec{v} \in V_h(\Omega), \text{div } \vec{v} = 0 \right\} \\ U_h^0(\Omega) &= \left\{ \vec{v} \in U_h(\Omega), \vec{v} \cdot \vec{n} = 0 \text{ on } \Gamma \right\} . \end{aligned}$$

We prove now that $K_h(\Omega)$ allows an exact representation of discrete vector fields in $U_h^0(\Omega) \subset H(\text{div}, \Omega)$.

THEOREM 4.2 The mapping curl is one to one from $K_h(\Omega)$ onto $U_h^0(\Omega)$:

$$(4.8) \quad \forall \vec{v}_h \in U_h^0(\Omega), \exists ! \vec{\varphi}_h \in K_h(\Omega), \text{curl } \vec{\varphi}_h = \vec{v}_h .$$

LEMMA 4.1 $\text{curl } W_h(\Omega) \subset V_h(\Omega)$.

PROOF OF LEMMA 4.1

Let $\vec{\varphi}$ be in $W_h(\Omega)$, then clearly $\text{curl } \vec{\varphi} \in H(\text{div}, \Omega)$ and it is enough to prove that in each element K of \mathcal{T}_h , $\text{curl } \vec{\varphi}$ belongs to $D_1(K)$. There exists some $\hat{\varphi} \in R_1(\hat{K})$ (cf. (3.14)) satisfying $\varphi(x) = {}^t dF^{-1}(\hat{x}) \cdot \hat{\varphi}(\hat{x})$. We denote by ϵ_{ijk} the totally antisymmetric tensor (e.g. GERMAIN-MULLER [25]). Then, due to (3.33),

$$(4.9) \quad (\text{curl } \vec{\varphi})_i = \frac{1}{2} \sum_{jklmn} \epsilon_{ijk} dF_{lj}^{-1} \epsilon_{lmn} (\text{curl } \vec{\varphi})_n dF_{mk}^{-1}$$

The sum

$$(4.10) \quad \frac{1}{2} \sum_{jklm} \epsilon_{ijk} \epsilon_{lmn} dF_{lj}^{-1} dF_{mk}^{-1}$$

is equal to $\frac{1}{\det(dF)} dF_{in}(\hat{x})$ because the following identity holds (GERMAIN-MULLER [25]):

$$\sum_{l,m,n} \epsilon_{lmn} dF_{lj}^{-1} dF_{mk}^{-1} dF_{n\alpha}^{-1} = \epsilon_{jk\alpha} \det(dF^{-1})$$

Then, replacing (4.10) in (4.9) we get

$$(4.11) \quad (\text{curl } \vec{\phi})_i = \sum_n \frac{1}{\det(dF(\hat{x}))} dF_{in}(\hat{x}) (\text{curl } \hat{\phi})_n$$

The vector $\text{curl } \hat{\phi}$ is constant in \hat{K} , thus it belongs to $D_1(\hat{K})$. Moreover the identity (4.11) shows that $\text{curl } \vec{\phi}$ is in $D_1(K)$, due to (3.6). ■

LEMMA 4.2 We have the following characterization of $U_h^0(\Omega)$:

$$(4.12) \quad U_h^0(\Omega) = \left\{ \vec{v} \in H(\text{div}, \Omega), \vec{v} \cdot \vec{n}|_{\Gamma} = 0, \exists \hat{v} \in (P_0)^3, (3.6) \text{ holds} \right\}$$

$$(4.13) \quad \dim U_h^0(\Omega) = N_f^* - N_e + 1.$$

PROOF OF LEMMA 4.2

• Let \vec{v} be a vector valued function of $U_h^0(\Omega)$. In the element K of \mathcal{T}_h (3.6) allows us to define $\hat{v} \in D_1$. From (3.8) we deduce easily $\int_K \text{div } \vec{v} dx = \int_{\hat{K}} \text{div } \hat{v} d\hat{x}$. Because $\text{div } \vec{v} = 0$ and $\text{div } \hat{v}$ is constant in \hat{K} , \hat{v} is constant on \hat{K} , and the characterization (4.12) holds.

• Inversely, if \vec{v} and \hat{v} satisfy (3.6) we have the identity

$$\text{div } \vec{v}(F(\hat{x})) = \frac{1}{J} \text{div } \hat{v}(\hat{x}) \quad \forall \hat{x} \in \hat{K}, J = \det dF(\hat{x})$$

which can be directly derived : by taking the divergence of (3.6), we get

$$(4.14) \quad \operatorname{div} \vec{v} = \sum_j \hat{v}_j \sum_{i,k} dF_{ki}^{-1} \frac{\partial}{\partial \hat{x}_k} \left(\frac{1}{J} dF_{ij} \right) + \frac{1}{J} \operatorname{div} \hat{v}$$

The sum over i,k in (4.14) is null because we have the classical identity on determinants :

$$\frac{\partial}{\partial \hat{x}_j} (J(\hat{x})) = \sum_{i,k} J dF_{ki}^{-1} \frac{\partial}{\partial \hat{x}_j} (dF_{ik})$$

Then $\operatorname{div} \vec{v} = 0$ in $\overset{\circ}{K}$. Moreover $\vec{v} \cdot \vec{n}$ is continuous along the faces of the mesh, and $\operatorname{div} \vec{v} = 0$.

- The space $U_h^0(\Omega)$ is defined by N_f^* degrees of freedom and N_e relations due to (4.12). But the family of linear forms

$$V_h^0(\Omega) \ni \vec{v} \mapsto \langle \chi_K, \vec{v} \rangle = \int_K \operatorname{div} \vec{v} \, dx \in \mathbb{R}, \quad K \text{ element of } \mathcal{T}_h$$

generates a linear space of dimension $(N_e - 1)$ because we have the relation

$\sum_{K \in \mathcal{T}_h} \int_K \operatorname{div} \vec{v} \, dx = 0$, for each $\vec{v} \in V_h^0(\Omega)$, and if we fix an element K_0 , let us suppose that the following linear sum is null :

$$(4.15) \quad \sum_{K \neq K_0} \alpha_K \chi_K = 0$$

Fix $K_1 \neq K_0$, θ regular function verifying

$$\begin{cases} \operatorname{supp} \theta \subset \bar{K}_0 \cup \bar{K}_1 \\ \theta > 0 \text{ in } \overset{\circ}{K}_0 ; \theta < 0 \text{ in } \overset{\circ}{K}_1 \\ \int_{\Omega} \theta \, dx = 0 \end{cases}$$

We denote by φ a solution of the problem

$$\begin{cases} \Delta\varphi = 0 & \Omega \\ \frac{\partial\varphi}{\partial n} = 0 & \Gamma \end{cases}$$

and we set : $\vec{v} = \pi_h^D(\nabla\varphi)$. The vector \vec{v} belongs to $V_h^0(\Omega)$ and according to Proposition 3.4 the integral $\int_K \text{div } \vec{v} \, dx$ is null for K different of K_0 and K_1 , and is positive for $K=K_1$. Then testing (4.15) on \vec{v} , we get $\alpha_{K_1} = 0$. So (4.13) holds. ■

PROOF OF THEOREM 4.2

- From Lemma 4.1, curl is well defined $W_h(\Omega) \rightarrow U_h(\Omega)$. Moreover if $\vec{\varphi}$ belongs to $W_h^0(\Omega)$, we have on the boundary of Ω : $\vec{\text{curl}} \vec{\varphi} \cdot \vec{n} \equiv \text{div}_\Gamma \vec{\varphi} \times \vec{n} = 0$, then $\vec{\text{curl}} \vec{\varphi}$ belongs to $U_h^0(\Omega)$.
- The mapping $\text{curl} : K_h(\Omega) \rightarrow U_h^0(\Omega)$ is injective. Let $\vec{\varphi}$ be a vector lying in $K_h(\Omega)$ satisfying $\vec{\text{curl}} \vec{\varphi} = 0$, and α be an edge of $A_h(\Omega) \setminus (A_h(\Gamma) \cup T_h(\Omega))$. Following Proposition 4.2, there exists some discrete surface Σ_α from the triangulation \mathcal{T}_h with a boundary γ_α composed only by edges of $\{\alpha\} \cup A_h(\Gamma) \cup T_h(\Omega)$. When we integrate $\vec{\text{curl}} \vec{\varphi}$ on Σ_α , we find $\int_{\gamma_\alpha} \vec{\varphi} \cdot d\vec{s} = \sigma_\alpha(\vec{\varphi})$, which is null because $\vec{\text{curl}} \vec{\varphi} = 0$.
- The linear spaces $K_h(\Omega)$ and $U_h^0(\Omega)$ have the same dimension. On one hand, we have clearly $\dim K_h(\Omega) = N_a - \sum_{i=1}^{N_\Gamma} n_{ai} - (N_s^* - 1) - (N_\Gamma + 1)$, and on the other hand, thanks to Lemma 4.2 : $\dim U_h^0(\Omega) = N_f^* - N_e + 1$. Moreover Theorem 4.1 shows that $N_s^* - N_a^* + N_f^* - N_e = -(N_\Gamma + 1)$. So (4.8) holds. ■

PROPOSITION 4.3 Suppose that \mathcal{T}_h satisfies Hypothesis 3.1, 3.2, 4.1. Then for $\vec{\varphi} \in (W^2(\Omega) \cap W^1(\Omega))$, there exists $\varphi_h \in K_h(\Omega)$ such that

$$\|\vec{c}\text{url } \vec{\varphi} - \vec{c}\text{url } \vec{\varphi}_h\|_{0,\Omega} \leq C h \|\vec{\varphi}\|_{W^2(\Omega)}$$

for some C independent of h .

PROOF OF PROPOSITION 4.3

From Theorem 3.2, the $H(\text{curl})$ interpolate $\Pi_h^R \vec{\varphi}$ in $W_h(\Omega)$ satisfies

$$\|\vec{\varphi} - \Pi_h^R \vec{\varphi}\|_{H(\text{curl}, \Omega)} \leq C h \|\vec{\varphi}\|_{W^2(\Omega)}$$

Moreover $\Pi_h^R \vec{\varphi} \in W_h^0(\Omega)$ since $\vec{\varphi} \times \vec{n} = 0$ on $\partial\Omega$. So $\vec{c}\text{url}(\Pi_h^R \vec{\varphi})$ belongs to $U_h^0(\Omega)$ and verifies

$$\|\vec{c}\text{url } \vec{\varphi} - \vec{c}\text{url } \Pi_h^R \vec{\varphi}\|_{0,\Omega} \leq C h \|\vec{\varphi}\|_{W^2(\Omega)}$$

Theorem 4.2 gives $\vec{\varphi}_h$ in $K_h(\Omega)$ satisfying

$$\vec{c}\text{url } \vec{\varphi}_h(x) = \vec{c}\text{url } \Pi_h^R \vec{\varphi}(x) \quad \forall x \in \Omega$$

and the Proposition is established. ■

2) MIXED APPROXIMATION AND ERROR ESTIMATE

We are now allowed to formulate a mixed discrete approximation of the continuous problem (4.1)-(4.3) in terms of a pair $(\vec{u}_h, \vec{\psi}_h)$ in $U_h^0(\Omega) \times K_h(\Omega)$.

PROPOSITION 4.4 Let \vec{f} and \vec{g} be two functions in $(L^2(\Omega))^3$. The problem

$$(4.16) \quad \begin{cases} \text{Find } (\vec{u}_h, \vec{\psi}_h) \in U_h^0(\Omega) \times K_h(\Omega) \\ \int_{\Omega} \vec{u}_h \cdot \vec{v}_h \, dx - \int_{\Omega} \vec{c}\text{url } \vec{\psi}_h \cdot \vec{v}_h \, dx = \int_{\Omega} \vec{f} \cdot \vec{v}_h \, dx & \forall \vec{v}_h \in U_h^0(\Omega) \\ \int_{\Omega} \vec{u}_h \cdot \vec{c}\text{url } \vec{\varphi}_h \, dx = \int_{\Omega} \vec{g} \cdot \vec{c}\text{url } \vec{\varphi}_h \, dx & \forall \vec{\varphi}_h \in K_h(\Omega) \end{cases}$$

admits a unique solution. Moreover we have

$$(4.17) \quad \|\vec{u}_h\|_{0,\Omega} + \|\text{curl } \vec{\psi}_h\|_{0,\Omega} \leq \|\vec{f}\|_{0,\Omega} + 2 \|\vec{g}\|_{0,\Omega}.$$

PROOF OF PROPOSITION 4.4

• To prove that (4.16) admits a unique solution we just have to consider the inf-sup property ([2,11]):

$$(4.18) \quad \exists c_h > 0, \forall \vec{\phi}_h \in K_h(\Omega), \sup_{\vec{v}_h \in U_h^0(\Omega)} \frac{\int_{\Omega} \text{curl } \vec{\phi}_h \cdot \vec{v}_h \, dx}{\|\vec{v}_h\|_{U_h^0(\Omega)}} \geq c_h \|\vec{\phi}_h\|_{K_h(\Omega)}$$

From Theorem 4.2, we can define a norm on $K_h(\Omega)$ by $\|\vec{\phi}\|_{K_h(\Omega)} = \|\text{curl } \vec{\phi}\|_{0,\Omega}$ and we choose in $U_h^0(\Omega)$ the norm L^2 . Then, given $\vec{\phi}_h$ in K_h , let us set $\vec{v}_h = -\text{curl } \vec{\phi}_h$. We get

$$\sup_{\vec{v}_h \in U_h^0(\Omega)} \frac{\int_{\Omega} \text{curl } \vec{\phi}_h \cdot \vec{v}_h \, dx}{\|\vec{v}_h\|_{0,\Omega}} \geq \frac{\int_{\Omega} \text{curl } \vec{\phi}_h \cdot \vec{v}_h \, dx}{\|\vec{v}_h\|_{0,\Omega}} = \|\text{curl } \vec{\phi}_h\|_{0,\Omega}$$

that demonstrates (4.18).

• We establish now the stability (4.17). Recall that we denote by $(\vec{u}_h, \vec{\psi}_h)$ the solution of (4.16). In the second equation of (4.16) take $\vec{\phi}_h$ verifying $\text{curl } \vec{\phi}_h = \vec{u}_h$. We clearly deduce

$$(4.19) \quad \|\vec{u}_h\|_{0,\Omega} \leq \|\vec{g}\|_{0,\Omega}$$

Make now the choice $\vec{v}_h = \text{curl } \vec{\psi}_h$ in the first equation, we get

$$\|\text{curl } \vec{\psi}_h\|_{0,\Omega}^2 = \int_{\Omega} \vec{u}_h \cdot \text{curl } \vec{\psi}_h \, dx - \int_{\Omega} \vec{f} \cdot \text{curl } \vec{\psi}_h \, dx$$

$$(4.20) \quad \|\text{curl } \vec{\psi}_h\|_{0,\Omega} \leq \|\vec{u}_h\|_{0,\Omega} + \|\vec{f}\|_{0,\Omega}$$

Thus (4.17) is obtained by adding (4.19) and (4.20). ■

REMARK 4.1 The mixed problem (4.16) has always one and only one solution for each choice of the (small) parameter h . The stability property (4.17) gives a good control of both \vec{u}_h and $\text{curl } \vec{\psi}_h$ which have a real physical meaning, but we have no control independent of h on the L^2 norm of the vector potential $\vec{\psi}_h$ and this is natural : for each value of h , the Definition 4.5 of $K_h(\Omega)$ holds in itself the choice of an arbitrary tree $T_h(\hat{\Omega})$ and arbitrary edges of $T_h(\Gamma)$. Therefore it is hopeless to improve the L^2 estimation with that kind of discrete gauge. Nevertheless, we recall that algebraically the linear system defined by (4.16) has a unique solution ; the numerical tests we have achieved (c.f. the Annex below) show that for a given mesh the change of $T_h(\Omega)$ have had little impact on the difficulty to solve the linear system.

We establish now the main result of this part. Let $\vec{\omega}$ be a given vorticity function on Ω :

$$\vec{\omega} \in (L^2(\Omega))^3, \quad \text{div } \vec{\omega} = 0, \quad P_N \vec{\omega} = 0$$

Consider the velocity field $\vec{u} \in (H^1(\Omega))^3$ satisfying (4.1)-(4.3) (cf. Theorem 2.5). Consider also the L^2 projection $\vec{\omega}_h$ of $\vec{\omega}$ over $U_h^0(\Omega)$:

$$(4.21) \quad \vec{\omega}_h \in U_h^0(\Omega), \quad \|\vec{\omega}_h\|_{0,\Omega} \leq \|\vec{\omega}\|_{0,\Omega}$$

$$(4.22) \quad \int_{\Omega} (\vec{\omega} - \vec{\omega}_h) \cdot \vec{v}_h \, dx = 0 \quad \forall \vec{v}_h \in U_h^0(\Omega)$$

and the following discrete problem :

$$(4.23) \quad \left\{ \begin{array}{l} \vec{u}_h \in U_h^0(\Omega), \quad \vec{\psi}_h \in K_h(\Omega) \\ \int_{\Omega} \vec{u}_h \cdot \vec{v}_h \, dx - \int_{\Omega} \text{curl } \vec{\psi}_h \cdot \vec{v}_h \, dx = 0 \quad \forall \vec{v}_h \in U_h^0(\Omega) \\ \int_{\Omega} \vec{u}_h \cdot \text{curl } \vec{\phi}_h \, dx = \int_{\Omega} \vec{\omega}_h \cdot \vec{\phi}_h \, dx \quad \forall \vec{\phi}_h \in K_h(\Omega) \end{array} \right.$$

We have :

THEOREM 4.3 Let $\vec{\omega}, \vec{\omega}_h, \vec{u}, \vec{u}_h$ be given as above. If \mathcal{F}_h satisfies the hypotheses 3.1, 3.2, 4.1, there exists some constant C (independent of h) such that

$$(4.24) \quad \|\vec{u} - \vec{u}_h\|_{0,\Omega} \leq C h \|\vec{\omega}\|_{0,\Omega} .$$

REMARK 4.2

The practical computation of $\vec{\omega}_h$ is not easy (it requires the inversion of the mass-matrix defined by the degrees of freedom in U_h^0) and we note that $\vec{\omega}_h$ is not the $H(\text{div})$ interpolate of $\vec{\omega}$. However, the estimate (4.24) is of optimal order as we noticed in the introduction.

PROOF OF THEOREM 4.3

We divide the proof in two parts.

- First, we consider the continuous solution \vec{q}_h of

$$(4.25) \quad \begin{cases} \text{div } \vec{q}_h = 0 & \Omega \\ \text{curl } \vec{q}_h = \vec{\omega}_h & \Omega \\ \vec{q}_h \cdot \vec{n} = 0 & \Gamma \end{cases}$$

Let $\vec{\varphi} \in W^1(\Omega)$. Its interpolate $\Pi_h^D \vec{\varphi}$ belongs to $U_h^0(\Omega)$ due to Proposition 3.4, thus we have

$$\begin{aligned} \int_{\Omega} (\vec{u} - \vec{q}_h) \cdot \text{curl } \vec{\varphi} \, dx &= \int_{\Omega} (\vec{\omega} - \vec{\omega}_h) \cdot \vec{\varphi} \, dx \\ &= \int_{\Omega} (\vec{\omega} - \vec{\omega}_h) \cdot (\vec{\varphi} - \Pi_h^D \vec{\varphi}) \, dx \quad (\text{thanks to (4.22)}) \\ &\leq \|\vec{\omega} - \vec{\omega}_h\|_{0,\Omega} \cdot C h \|\vec{\varphi}\|_{1,\Omega} \quad (\text{cf. Th. 3.1}) \\ &\leq 2 C h \|\vec{\omega}\|_{0,\Omega} \|\vec{\varphi}\|_{1,\Omega} \quad (\text{cf. (4.21)}) \end{aligned}$$

$$\int_{\Omega} (\vec{u} - \vec{q}_h) \cdot \text{curl } \vec{\varphi} \, dx \leq C h \|\vec{\omega}\|_{0,\Omega} \|\text{curl } \vec{\varphi}\|_{0,\Omega}$$

according to Proposition 2.4. We choose now $\vec{\varphi}$ as the vector-potential of

$(\vec{u} - \vec{q}_h)$ thanks to Theorem 2.5 ; we get :

$$(4.26) \quad \|\vec{u} - \vec{q}_h\|_{0,\Omega} < C h \|\vec{\omega}\|_{0,\Omega}$$

• Secondly, the field \vec{q}_h introduced above in (4.25) admits a continuous potential \vec{x}_h (according to Theorem 2.5) satisfying:

$$\begin{cases} \int_{\Omega} \vec{q}_h \cdot \vec{v} \, dx - \int_{\Omega} \text{curl} \vec{x}_h \cdot \vec{v} \, dx = 0 & \forall \vec{v} \in (L^2(\Omega))^3 \\ \int_{\Omega} \vec{q}_h \cdot \text{curl} \vec{\varphi} \, dx = \int_{\Omega} \vec{\omega}_h \cdot \vec{\varphi} \, dx & \forall \vec{\varphi} \in W^1(\Omega) \end{cases}$$

Let us fix for a time $(\vec{u}_h, \vec{\psi}_h) \in U_h^0 \times K_h$. Because $U_h^0(\Omega) \subset (L^2(\Omega))^3$, we have :

$$(4.27) \quad \begin{aligned} & \int_{\Omega} (\vec{u}_h - \vec{u}_h) \cdot \vec{v}_h \, dx - \int_{\Omega} \text{curl} (\vec{\psi}_h - \vec{\psi}_h) \cdot \vec{v}_h \, dx = \\ & = \int_{\Omega} (\vec{q}_h - \vec{u}_h) \cdot \vec{v}_h \, dx - \int_{\Omega} \text{curl} (\vec{x}_h - \vec{\psi}_h) \cdot \vec{v}_h \, dx \quad , \quad \forall \vec{v}_h \in U_h^0(\Omega) \end{aligned}$$

Since $K_h(\Omega)$ is not included in $W^1(\Omega)$, we must proceed otherwise with the second equation. We multiply the second line of (4.25) by $\vec{\varphi}_h \in K_h(\Omega)$, we integrate by parts (cf. (1.21)) and the boundary term vanishes because $\vec{\varphi}_h \times \vec{n} = 0$. Thus we have

$$(4.28) \quad \int_{\Omega} \vec{q}_h \cdot \text{curl} \vec{\varphi}_h \, dx = \int_{\Omega} \vec{\omega}_h \cdot \vec{\varphi}_h \, dx$$

We subtract (4.28) from the second equation of (4.23), and we obtain :

$$(4.29) \quad \int_{\Omega} (\vec{u}_h - \vec{u}_h) \cdot \text{curl} \vec{\varphi}_h \, dx = \int_{\Omega} (\vec{q}_h - \vec{u}_h) \cdot \text{curl} \vec{\varphi}_h \, dx \quad , \quad \forall \vec{\varphi}_h \in K_h(\Omega)$$

Then the pair $(\vec{u}_h - \vec{u}_h, \vec{\psi}_h - \vec{\psi}_h)$ is solution (due to (4.27) and (4.29)) of a mixed discrete problem (4.16) ; the Proposition 4.4 gives stability :

$$\|\vec{u}_h - \tilde{u}_h\|_{0,\Omega} \leq C \left(\|\vec{q}_h - \tilde{u}_h\|_{0,\Omega} + \|\text{curl}(\vec{x}_h - \tilde{\psi}_h)\|_{0,\Omega} \right)$$

Then using the triangle inequality we get

$$\|\vec{u}_h - \vec{q}_h\|_{0,\Omega} \leq C \inf_{\tilde{u}_h \in U_h^0, \tilde{\psi}_h \in K_h} \left\{ \|\vec{q}_h - \tilde{u}_h\|_{0,\Omega} + \|\text{curl}(\vec{x}_h - \tilde{\psi}_h)\|_{0,\Omega} \right\}$$

Take now for \tilde{u}_h (resp. $\tilde{\psi}_h$) the interpolate in $U_h^0(\Omega)$ (resp. $K_h(\Omega)$) defined according to Theorem 3.1 (resp. Proposition 4.3) of \vec{q}_h (resp. \vec{x}_h). We deduce

$$\begin{aligned} \|\vec{u}_h - \vec{q}_h\|_{0,\Omega} &\leq C h \left(\|\vec{q}_h\|_{1,\Omega} + \|\vec{x}_h\|_{W^2(\Omega)} \right) \\ &\leq C h \|\vec{\omega}_h\|_{0,\Omega} \end{aligned} \quad (\text{cf. Theorem 2.5})$$

$$(4.30) \quad \|\vec{u}_h - \vec{q}_h\|_{0,\Omega} \leq C h \|\vec{\omega}_h\|_{0,\Omega} \quad (\text{cf. (4.21)}) .$$

The conclusion of the Theorem is consequence of both (4.26) and (4.30). ■

V - THE DIRICHLET BOUNDARY CONDITION

We focus in this last paragraph on the approximation of an harmonic vector field \vec{u} with given mass inflow and outflow on the boundary :

$$(5.1) \quad \operatorname{div} \vec{u} = 0 \quad \Omega$$

$$(5.2) \quad \operatorname{curl} \vec{u} = 0 \quad \Omega$$

$$(5.3) \quad \vec{u} \cdot \vec{n} = g \quad \Gamma$$

We suppose that

$$(5.4) \quad \int_{\Gamma_i} g \, d\gamma = 0 \quad \forall i = 0, 1, \dots, N_\Gamma$$

to be sure that \vec{u} admits a representation in terms of a vector potential $\vec{\psi}$ (cf. Proposition 2.5) : $\vec{u} = \operatorname{curl} \vec{\psi}$. Moreover a boundary equation is satisfied by the tangential component $\Pi \vec{\psi}$ on $\partial\Omega$:

$$(5.5) \quad \operatorname{curl}_\Gamma \Pi \vec{\psi} = g \quad \text{on } \Gamma$$

We first study an approximation of (5.5) : we recall the results of BENDALI [3,5] and NEDELEC [36] for constructing vectorial finite elements on the boundary, and we propose a discrete gauge condition to insure the uniqueness of the tangential component in a discrete version of (5.5). Secondly, we use a discrete extension to replace ourselves in the homogeneous case studied in part IV.

The boundary Γ admits $(N_\Gamma + 1)$ simply connected components Γ_i , and the equation (5.5) is thus decoupled in $(N_\Gamma + 1)$ different boundary equations. Therefore in paragraphs 1 and 2 we look at a connected manifold Γ_i , and in the paragraph 3, we study the boundary Γ of Ω .

1) FINITE ELEMENTS ON THE BOUNDARY

We have developed in the part III curved finite elements in order to insure that the approached domain Ω_h is exactly Ω . Moreover, the boundary $\partial\Omega$ is exactly covered by curved faces of the triangulation \mathcal{T}_h . We will denote by $\mathcal{T}_h(\Gamma)$ the mesh defined on Γ by \mathcal{T}_h (i.e. the points $P_h(\Gamma)$, the edges $A_h(\Gamma)$ and the curvilinear triangles which are the faces of Γ). We can suppose that each triangle k of $\mathcal{T}_h(\Gamma)$ is the range of $\hat{k} = \{(\hat{x}_1, \hat{x}_2, 0) \in \mathbb{R}^3, \hat{x}_1 \geq 0, \hat{x}_2 \geq 0, \hat{x}_1 + \hat{x}_2 \leq 1\}$ by the mapping F defined in (3.1). Moreover as \hat{k} is a face of \hat{K} (Definition 3.1), the triangle k is a face of some curved tetrahedron K of \mathcal{T}_h , and we denote by F_k the restriction of F to \hat{k} . The straight tetrahedron \tilde{K} defined by the vertices of K , and parameterized by $\hat{K} \ni \hat{x} \mapsto (B\hat{x} + b) \in \tilde{K}$ defines a plane triangle \tilde{k} whose union recover an approximated surface Γ_h of Γ . On Figure 5.1, we show that k is parameterized by \tilde{k} due to the normal projection P_Γ on the surface $\tilde{k} \ni \tilde{x} \mapsto x = P_\Gamma(\tilde{x}) \in k$ as it was first proposed by NEDELEC [34].

Moreover let $(\hat{e}_i)_{i=1,2,3}$ be the canonical basis of \mathbb{R}^3 . The total gaussian curvature $G(x)$ and the normal $n(x)$ of Γ at the point $x = F(\hat{x})$ of k admit the expressions :

$$G(x) = |dF(\hat{x}) \cdot \hat{e}_1 \times dF(\hat{x}) \cdot \hat{e}_2|^2$$

$$n(x) = \frac{1}{\sqrt{G(x)}} \left(dF(\hat{x}) \cdot \hat{e}_1 \times dF(\hat{x}) \cdot \hat{e}_2 \right)$$

$$n(x) = \frac{1}{\sqrt{G(x)}} \left(dF_k(\hat{x}) \cdot \hat{e}_1 \times dF_k(\hat{x}) \cdot \hat{e}_2 \right)$$

DEFINITION 5.1 (NEDELEC [36])

$$R'_1 = \left\{ \hat{n} : \hat{k} \rightarrow \mathbb{R}^2, \exists \alpha, \beta, \gamma \in \mathbb{R}, \hat{n}_1(\hat{x}) = \alpha + \gamma \hat{x}_2, \hat{n}_2(\hat{x}) = \beta - \gamma \hat{x}_1 \right\} .$$

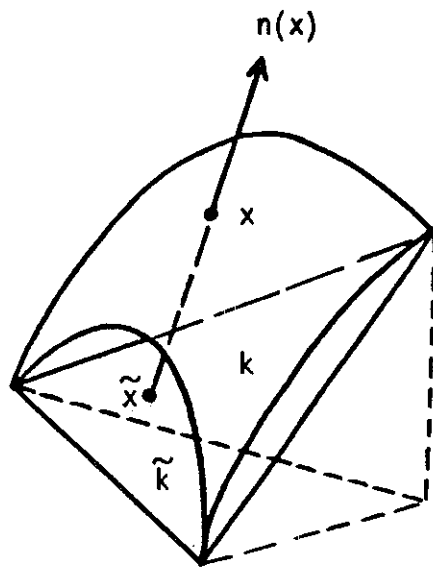

Figure 5.1

Curvilinear triangle on the boundary

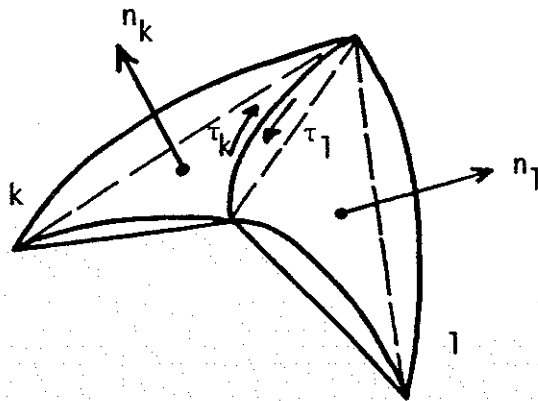

Figure 5.2

Adjacent triangles on the boundary

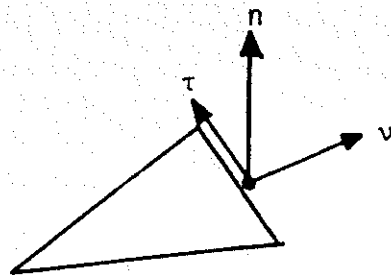

Figure 5.3

DEFINITION 5.2 *Local spaces for the approximation of tangent vectors on Γ .*

$$R_1'(k) = \left\{ \eta : k \rightarrow \mathbb{R}^3, \exists \hat{\eta} \in R_1' / \forall \hat{x} \in \hat{k} \right. \\ \left. \eta(F(\hat{x})) = \frac{1}{\sqrt{G(F(\hat{x}))}} dF(\hat{x}) \cdot \hat{\eta} \right\} .$$

The global finite element spaces for the interpolation of densities (which belong to $M(\Gamma)$) and currents (lying in $TH^{\frac{1}{2}}(\Gamma)$) are given now :

DEFINITION 5.3

$$M_h(\Gamma) = \left\{ w \in L^2(\Gamma), \forall k \in \mathcal{T}_h(\Gamma), \exists \hat{w} \in \mathbb{R}, \forall \hat{x} \in \hat{k}, \right. \\ \left. w(F(\hat{x})) = \frac{\hat{w}}{\sqrt{G(\hat{x})}}, \int_{\Gamma} w \, d\gamma = 0 \right\}$$

For k, l two triangles of $\mathcal{T}_h(\Gamma)$ intersecting themselves in an edge a , we denote by $\vec{\tau}_k$ and $\vec{\tau}_l$ the two tangent vectors which are compatible with the orientation defined on k and l by the external normal to Γ (figure 5.2). We set

$$X_h(\Gamma) = \left\{ \vec{n} : \Gamma \rightarrow \mathbb{R}^3, \forall k \in \mathcal{T}_h(\Gamma), \vec{n}|_k \in R_1'(k), \right. \\ \forall a = k \cap l \text{ edge of } \mathcal{T}_h(\Gamma), \\ \left. \int_a (\vec{n} \cdot \vec{\tau}_k + \vec{n} \cdot \vec{\tau}_l) \, ds = 0 \right\} .$$

(5.6)

The degrees of freedom in $M_h(\Gamma)$ and $X_h(\Gamma)$ are respectively :
 $\sigma_k(w) = \int_k w(x) \, d\gamma(x)$, k element of $\mathcal{T}_h(\Gamma)$ and $\Sigma_a = \left\{ \sigma_a(\vec{n}) = \int_a \vec{n} \cdot \vec{ds}, \right.$
 a edge of $\mathcal{T}_h(\Gamma) \left. \right\}$. We define now interpolation operators in $M_h(\Gamma)$ and $X_h(\Gamma)$.

THEOREM 5.1 (NEDELEC [34]) *There exists an operator $P_h^S : L^2(\Gamma) \cap M(\Gamma) \rightarrow M_h(\Gamma)$ defined by $\int_k P_h^S w \, d\gamma = \int_k w \, d\gamma$, $\forall k \in \mathcal{T}_h(\Gamma)$ and if \mathcal{E}_h is regular (Hypothesis 3.1, 3.2) we have*

$$(5.7) \quad \|w - P_h^S w\|_{-\frac{1}{2}, \Gamma} \leq C h \|w\|_{\frac{1}{2}, \Gamma}, \quad w \in H^{\frac{1}{2}}(\Gamma)$$

for some constant C .

THEOREM 5.2 (BENDALI [5]) *Let s be real, $s > \frac{1}{2}$. There exists an interpolation operator $P_h^C : TH^s(\Gamma) \rightarrow X_h(\Gamma)$ defined by $\int_a P_h^C \vec{n} \cdot \vec{d}s = \int_a \vec{n} \cdot \vec{d}s$, a edge on \mathcal{T}_h , we have :*

$$\|\vec{n} - P_h^C \vec{n}\|_{0, \Gamma} \leq C h^s \|\vec{n}\|_{s, \Gamma}, \quad \frac{1}{2} < s \leq 1, \quad \vec{n} \in TH^s.$$

PROPOSITION 5.1 *We have the following relations between $X_h(\Gamma)$, $M_h(\Gamma)$ and the curl operator on Γ :*

$$(5.8) \quad \text{curl } X_h(\Gamma) \subset M_h(\Gamma)$$

$$(5.9) \quad P_h^S (\text{curl}_\Gamma \vec{n}) = \text{curl}_\Gamma (P_h^C \vec{n}), \quad \forall \vec{n} \in TH^s(\Gamma), \quad s > \frac{1}{2}.$$

PROOF OF PROPOSITION 5.1

• The inclusion $\text{curl}_\Gamma X_h \subset L^2(\Gamma)$ is a direct consequence of the continuity of the tangential component $\vec{n} \cdot \vec{\tau}_a$ of the functions $\vec{n} \in X_h(\Gamma)$ on the edges a of $\mathcal{T}_h(\Gamma)$ according to (5.6). Moreover the integral of $\text{curl}_\Gamma \vec{n}$ on Γ is always null and $\text{curl}_\Gamma X_h \subset M_h(\Gamma)$. In each triangle k of $\mathcal{T}_h(\Gamma)$ we have the general identity :

$$\text{curl}_\Gamma \left\{ \frac{1}{\sqrt{G}} \, dF \cdot \hat{\vec{n}} \right\} = \frac{1}{\sqrt{G}} (\text{curl}_{\mathbb{R}^2} \hat{\vec{n}})$$

Thus if \vec{n} belongs to $R_1'(k)$, \hat{n} lies in R_1' and $\text{curl}_{\mathbb{R}^2} \hat{n}$ is a constant function, which implies (5.8).

- The proof of (5.9) is standard : integrate $P_h^S(\text{curl}_\Gamma \vec{n})$ on k :

$$\begin{aligned} \int_k P_h^S(\text{curl}_\Gamma \vec{n}) d\gamma &= \int_k \text{curl}_\Gamma \vec{n} d\gamma = \int_k \text{div}_\Gamma(\vec{n} \times \vec{n}) d\gamma \\ &= \int_{\partial K} \vec{n} \times \vec{n} \cdot \vec{\nu} ds \quad (\text{cf. figure 5.3}) \\ &= \int_{\partial K} \vec{n} \cdot \vec{ds} = \int_{\partial K} P_h^C \vec{n} \cdot \vec{ds} = \int_k \text{curl}_\Gamma(P_h^C \vec{n}) d\gamma \end{aligned}$$

Thus the two functions of the equality (5.9) have the same degrees of freedom in $M_h(\Gamma)$. Then they are equal. ■

2) APPROXIMATION OF THE BOUNDARY PROBLEM

We first define a discrete subspace of $X_h(\Gamma)$ in which the curl_Γ operator is one to one onto $M_h(\Gamma)$.

DEFINITION 5.4 We define \vec{n}_a as the natural basis of $X_h(\Gamma)$, parameterized by the graph $A_h(\Gamma)$ of the edges of $\mathcal{E}_h(\Gamma)$: $\sigma_a(\vec{n}_b) = \delta_{a,b}$ for a, b edges of $\mathcal{E}_h(\Gamma)$.

DEFINITION 5.5 Let us consider a given tree $T_h(\Gamma)$ in the graph $A_h(\Gamma)$.

We set

$$Y_h(\Gamma) = \text{span} \langle \vec{n}_a, a \in A_h(\Gamma) \setminus T_h(\Gamma) \rangle$$

THEOREM 5.3 The operator curl_Γ is one to one from $Y_h(\Gamma)$ onto $M_h(\Gamma)$:

$$\forall w_h \in M_h(\Gamma), \exists ! \vec{n}_h \in Y_h(\Gamma), \text{curl}_\Gamma \vec{n}_h = w_h$$

PROOF OF THEOREM 5.3

• First the spaces $Y_h(\Gamma)$ and $M_h(\Gamma)$ have dimensions $n_a - (n_s - 1)$ and $n_f - 1$ respectively ; those numbers are equal according to Theorem 4.1 on Euler characteristic.

• Secondly curl_Γ is injective on $Y_h(\Gamma)$. The proof given for the Theorem 4.2 is the same. Let α be an edge of $A_h(\Gamma) \setminus T_h(\Gamma)$; the cycle γ_α generated by α and $T_h(\Gamma)$ is the boundary of some discrete surface Σ_α over which we integrate the null scalar $\text{curl}_\Gamma \vec{n}$ ($\vec{n} \in Y_h(\Gamma)$). We find

$\int_{\Sigma_\alpha} \text{curl}_\Gamma \vec{n} d\gamma = \sigma_\alpha(\vec{n}) = 0$. This statement is true for each edge α of $A_h(\Gamma)$, therefore $\vec{n} = 0$. ■

Let now g be a given scalar function of $H^{\frac{1}{2}}(\Gamma) \cap M(\Gamma)$ and $\vec{\xi}$ the (unique) solution lying in $W^{\frac{1}{2}}(\Gamma)$ of the continuous problem (cf. Proposition 2.7)

$$(5.10) \quad \text{curl}_\Gamma \vec{\xi} = g \quad , \quad \text{div}_\Gamma \vec{\xi} = 0$$

whose mixed variational formulation is (see (2.24))

$$(5.11) \quad \left\{ \begin{array}{l} \vec{\xi} \in W^{\frac{1}{2}}(\Gamma) \quad , \quad \theta \in L^2(\Gamma) \cap M(\Gamma) \\ \int_\Gamma \vec{\xi} \cdot \vec{n} d\gamma - \int_\Gamma \theta \text{curl}_\Gamma \vec{n} d\gamma = 0 \\ \int_\Gamma \text{curl}_\Gamma \vec{\xi} w d\gamma = \int_\Gamma g w d\gamma \end{array} \right. \quad \begin{array}{l} \forall \vec{n} \in W^{\frac{1}{2}}(\Gamma) \\ \forall w \in L^2(\Gamma) \cap M(\Gamma) \end{array}$$

We denote also by g_h the interpolate of g in $M_h(\Gamma)$. We have, according to Theorem 5.1 :

$$(5.12) \quad \|g - g_h\|_{-\frac{1}{2}, \Gamma} \leq C h \|g\|_{\frac{1}{2}, \Gamma}$$

DEFINITION 5.5 We will denote in the following by $\vec{\xi}_h$ the unique vector valued function of $Y_h(\Gamma)$ such that

$$(5.13) \quad \text{curl}_\Gamma \vec{\xi}_h = g_h$$

Due to (5.10) and (5.12) we have

$$(5.14) \quad \|\text{curl}_\Gamma \vec{\xi} - \text{curl}_\Gamma \vec{\xi}_h\|_{-\frac{1}{2}, \Gamma} \leq C h \|g\|_{\frac{1}{2}, \Gamma} .$$

REMARK 5.1

The discrete gauge on the boundary gives a solution $\vec{\xi}_h$ of (5.13) which is very easy to compute ; there indeed exists an enumeration of the edges (related to the tree $T_h(\Gamma)$) such that (5.13) is reduced to a triangular system. The idea of decoupling the discrete gauge in the domain (part IV) and on the boundary was first proposed by ROUX [41] in a particular case.

3) EXTENSION OF THE BOUNDARY PROBLEM

We now solve the part of the original problem (5.1)-(5.4) corresponding to zero prescribed vorticity in Ω and a given nonzero mass flow g on the boundary Γ of Ω . The spaces $X_h(\Gamma_i)$ and $Y_h(\Gamma_i)$ introduced previously can be viewed as subspaces of $W_h(\Omega)$ (cf. Definition 3.4) :

DEFINITION 5.6 Let $\vec{\phi}_a$, $a \in A_h(\Omega)$, be the basis of $W_h(\Omega)$ introduced in Definition 4.3, and let $T_h(\Gamma_i)$ be given trees on the subgraphs $A_h(\Gamma_i)$.

We set

$$X_h(\Omega) = \text{span} \langle \vec{\phi}_a, a \in A_h(\Gamma_i), i=0, \dots, N_\Gamma \rangle$$

$$Y_h(\Omega) = \text{span} \langle \vec{\phi}_a, a \in A_h(\Gamma_i) \setminus T_h(\Gamma_i), i=0, \dots, N_\Gamma \rangle .$$

PROPOSITION 5.2 If $\vec{\varphi}$ belongs to $X_h(\Omega)$ (resp. $Y_h(\Omega)$), its tangential component $\Pi\vec{\varphi}$ belongs to $X_h(\Gamma_i)$ (resp. $Y_h(\Gamma_i)$) for some i .

PROOF OF PROPOSITION 5.2

This is a consequence of the $H(\text{curl}, \Omega)$ unisolvence of $(K, \Sigma_a, R_1(K))$ proved in Proposition 3.2 : the tangential components of $\vec{\varphi}$ on the face k is only function of the degrees of freedom $\sigma_a(\vec{\varphi})$ for the edges a of ∂k . Moreover we see easily that the spaces $R_1'(k)$ are exactly the sets of the tangential components on k of the functions of $R_1(K)$. The statement is thus established. ■

PROPOSITION 5.3 Suppose that \mathcal{F}_h satisfies the Hypothesis 3.1, 3.2, 4.1.

Let us give now g in $H^{\frac{1}{2}}(\Gamma) \cap M(\Gamma)$ verifying $\int_{\Gamma_i} g \, d\gamma = 0$ for $i = 0, 1, \dots, N_\Gamma$. We consider the solution $\vec{\xi}$ of (5.11), the interpolate g_h of g in $M_h(\Gamma) \equiv \bigoplus_{i=0}^{N_\Gamma} M_h(\Gamma_i)$. There exists $\vec{\zeta}_h \in Y_h(\Omega)$ satisfying

$$(5.15) \quad \text{curl}_\Gamma \Pi\vec{\zeta}_h = g_h$$

$$(5.16) \quad \|\text{curl}_\Gamma \vec{\xi} - \text{curl}_\Gamma \Pi\vec{\zeta}_h\|_{-\frac{1}{2}, \Gamma} \leq C h \|g\|_{\frac{1}{2}, \Gamma}$$

for some constant C .

PROOF Direct consequence of (5.14) and of Proposition 5.2. ■

PROPOSITION 5.4 Let $g, g_h, \vec{\zeta}_h$ be defined as above, and \vec{u} be the solution of (5.1)-(5.3). The vector $\Pi_h^D \vec{u} - \text{curl}_\Gamma \vec{\zeta}_h$ belongs to $U_h^0(\Omega)$, and we set

$$(5.17) \quad \vec{u}_h^\sim = \Pi_h^D \vec{u} - \text{curl}_\Gamma \vec{\zeta}_h .$$

PROOF OF PROPOSITION 5.4

The scalar function $\operatorname{div} \Pi_h^D \vec{u}$ is equal to zero according to Proposition 3.4. Moreover, due to Lemma 4.1, $\operatorname{curl} \vec{z}_h$ belongs to $U_h(\Omega)$. We deduce that \tilde{u}_h belongs also to $U_h(\Omega)$. Then we just have to prove that the normal component $(\Pi_h^D \vec{u} - \operatorname{curl} \vec{z}_h) \cdot \vec{n}$ is null on Γ , i.e. that its integral on each face is null, according to Lemma 4.2. But we have

$$\begin{aligned}
 \int_k \Pi_h^D \vec{u} \cdot \vec{n} \, d\gamma &= \int_k \vec{u} \cdot \vec{n} \, d\gamma && \text{(cf. (3.10))} \\
 &= \int_k g \, d\gamma && \text{(cf. (5.3))} \\
 &= \int_k g_h \, d\gamma && \text{(cf. (5.7))} \\
 &= \int_k \operatorname{curl}_\Gamma \Pi z_h \, d\gamma && \text{(cf. (5.15))} \\
 &= \int_k \operatorname{curl} \vec{z}_h \cdot \vec{n} \, d\gamma && \text{(cf. Lemma 2.1) .}
 \end{aligned}$$

THEOREM 5.4 Let $g, \vec{u}, g_h, \vec{z}_h, \tilde{u}_h$ be defined in Proposition 5.4. Consider u_h , represented as $\vec{u}_h = \operatorname{curl} \vec{z}_h + \vec{v}_h$ with \vec{v}_h solution of the discrete mixed problem

$$(5.18) \quad \left\{ \begin{array}{l} v_h \in U_h^0(\Omega), \quad \vec{\psi}_h \in K_h(\Omega) \\ \int_\Omega \vec{v}_h \cdot \vec{w}_h \, dx - \int_\Omega \operatorname{curl} \vec{\psi}_h \cdot \vec{w}_h \, dx = 0 \quad \forall \vec{w}_h \in U_h^0 \\ \int_\Omega \vec{v}_h \cdot \operatorname{curl} \vec{\phi}_h \, dx = - \int_\Omega \operatorname{curl} \vec{z}_h \cdot \operatorname{curl} \vec{\phi}_h \, dx \quad \forall \vec{\phi}_h \in K_h \end{array} \right.$$

Then, if \mathcal{T}_h satisfies the Hypothesis 3.1, 3.2, 4.1, we have :

$$\|\vec{u} - \vec{u}_h\|_{0,\Omega} \leq Ch \|g\|_{\frac{1}{2},\Gamma} .$$

PROOF OF THEOREM 5.4

- We consider first the solution \vec{v} of the continuous problem

$$\begin{cases} \operatorname{div} \vec{v} = 0 & \Omega \\ \operatorname{curl} \vec{v} = -\operatorname{curl} \vec{z}_h & \Omega \\ \vec{v} \cdot \vec{n} = 0 & \Gamma \end{cases}$$

or

$$(5.19) \quad \begin{cases} \vec{v} \in (L^2(\Omega))^3, \vec{\psi} \in W^1(\Omega) \\ \int_{\Omega} \vec{v} \cdot \vec{w} \, dx - \int_{\Omega} \operatorname{curl} \vec{\psi} \cdot \vec{w} \, dx = 0 & \forall \vec{w} \in (L^2(\Omega))^3 \\ \int_{\Omega} \vec{v} \cdot \operatorname{curl} \vec{\phi} \, dx = - \int_{\Omega} \operatorname{curl} \vec{z}_h \cdot \operatorname{curl} \vec{\phi} \, dx & \forall \vec{\phi} \in K_h(\Omega) \end{cases}$$

The field $\vec{u} - (\vec{v} + \operatorname{curl} \vec{z}_h)$ is harmonic (its divergence and curl are null) and its normal component on Γ is exactly $(g - g_h)$. Due to Proposition 2.9 and (5.12) we have

$$(5.20) \quad \|\vec{u} - (\vec{v} + \operatorname{curl} \vec{z}_h)\|_{0,\Omega} \leq C h \|g\|_{\frac{1}{2},\Gamma}.$$

- We just have to establish a similar inequality for the vector $\vec{u}_h - \vec{v} - \operatorname{curl} \vec{z}_h = \vec{v}_h - \vec{v}$. Let $\vec{\phi}_h$ be in $K_h(\Omega)$. Then $\operatorname{curl} \vec{\phi}_h \in (L^2(\Omega))^3$ and Theorem 2.4 (i) gives

$$(5.21) \quad \operatorname{curl} \vec{\phi}_h = \nabla p + \operatorname{curl} \vec{\phi}$$

with $p \in H^1 \cap L_0^2$, $\vec{\phi} \in W^1$. Because $\Pi \vec{\phi}_h = 0$ if $\vec{\phi}_h \in K_h(\Omega)$ we have $\operatorname{div}_{\Gamma} \vec{\phi}_h \times \vec{n} = 0$ and finally $p = 0$. We insert the function $\vec{\phi}$ defined in (5.21) as a test function in the second equation of (5.19). We get

$$\int_{\Omega} \vec{v} \cdot \operatorname{curl} \vec{\phi}_h \, dx = - \int_{\Omega} \operatorname{curl} \vec{z}_h \cdot \operatorname{curl} \vec{\phi}_h \, dx, \quad \forall \vec{\phi}_h \in K_h(\Omega) \text{ and by}$$

subtracting from (5.18) we deduce, due to Theorem 4.2, the equality:

$$(5.22) \quad \int_{\Omega} (\vec{v} - \vec{v}_h) \cdot \vec{w}_h \, dx = 0 \quad \forall \vec{w}_h \in U_h^0(\Omega)$$

But we have

$$(5.23) \quad \vec{v} - \vec{w}_h = (\vec{v} + \text{rot } \zeta_h - \vec{u}) + (\vec{u} - (\text{rot } \zeta_h + \vec{w}_h))$$

We chose $\vec{w}_h = \tilde{u}_h$ of (5.17). According to (5.22) and (5.23)

$$\begin{aligned} \|\vec{v} - \vec{v}_h\|_{0,\Omega} &\leq \|\vec{v} - \tilde{u}_h\|_{0,\Omega} \\ &\leq \|\vec{u} - (\vec{v} + \text{rot } \zeta_h)\|_{0,\Omega} + \|\vec{u} - \Pi_h^D \vec{u}\|_{0,\Omega} \\ &\leq C h \|g\|_{\frac{1}{2},\Gamma} + C h \|\vec{u}\|_{1,\Omega} \end{aligned}$$

then

$$(5.24) \quad \|\vec{v} - \vec{v}_h\|_{0,\Omega} \leq C h \|g\|_{\frac{1}{2},\Gamma}$$

due to Theorem 2.4 (i). The inequalities (5.20) and (5.24) prove the Theorem. ■

CONCLUSION

In this paper, we have studied the discretization of a solenoidal vector field through the curl of a vector potential. We have recalled that two gauge conditions have to be prescribed for this potential, which are both written with divergence operators. We have seen in parts IV and V that these conditions have a discrete analogy in terms of trees in the graph defined by the edges of the mesh. The error estimates obtained only concern the solenoidal field because the arbitrary choice induced by the discrete gauges does not insure any a priori simple L^2 stability for the potential.

A direct application of this work is the numerical study of compressible flow and incompressible Navier-Stokes equations developed in Ecole Polytechnique at Palaiseau (DUBOIS-DUPUY [18,19], ROUX [41]). This study of the numerical error order could be followed in different fields: first to treat approximations of arbitrary order with help of the $H(\text{curl})$ conforming elements proposed by NEDELEC [37] and more recently by BREZZI-DOUGLAS-MARINI [12] and NEDELEC [39]. On the other hand, the hypothesis of smooth boundary could be avoided and one could study more realistic physical problems of fluid dynamics like the Stokes problem in \mathbb{R}^3 in (Ψ, ω) formulation (GIRAULT-RAVIART [26], NEDELEC [38]). Finally the discrete gauge could be generalized to non simply connected domains of \mathbb{R}^3 .

ANNEX. A NUMERICAL EXPERIMENT

The matter presented above explains rigorously how to approximate a divergence free vector field in \mathbb{R}^3 with a vector potential conforming in $H(\text{curl})$ when the domain admits a smooth (eventually non connected) boundary. In practice, most of the computational domains have a polyhedral boundary and the analysis is not applicable. Nevertheless, the numerical procedure developed in parts IV and V can be applied without any modification when $\partial\Omega$ is polyhedral. In this annex, we show that the numerical algorithms described previously can be implemented without any trouble in the case of a very simple problem. More precisely, the discrete spaces $K_h(\Omega)$ (resp $Y_h(\Omega)$) introduced at the definition 4.5 (resp definition 5.6) can be constructed without any help to curved finite elements. However the practical construction of the trees $T_h(\Omega)$ and $T_h(\Gamma)$ gives to the user a great number of degrees of freedom in the choice of the spaces $K_h(\Omega)$ and $Y_h(\Omega)$.

In the following we present the practical solution of a very simple problem posed on $\Omega = (]0,1[)^3$. We have used prismatic finite elements instead of tetrahedrons and we describe quickly the associated discrete function spaces. The choice of the tree $T_h(\Omega)$ on the boundary is the one done by ROUX [41]. The three-dimensional stream function is computed by solving a definite symmetric linear system with a conjugate gradient method. We present also two different choices of the internal tree $T_h(\Omega)$ and their relative influence on the practical solution of the linear system.

1) The test case

The domain Ω is the square $(]0,1[)^3$. The face $(]0,1[)^2 \times \{0\}$ corresponds to the inflow and the opposite face corresponds to the outflow. We solve the problem:

$$\begin{aligned}
(A1) \quad & \operatorname{div} \vec{u} = 0 & \Omega \\
(A2) \quad & \operatorname{curl} \vec{u} = 0 & \Omega \\
(A3) \quad & \vec{u} \cdot \vec{n} = -1 & \Gamma_i = (]0,1[)^2 \times (0) \\
(A4) \quad & \vec{u} \cdot \vec{n} = +1 & \Gamma_o = (]0,1[)^2 \times (1) \\
(A5) \quad & \vec{u} \cdot \vec{n} = 0 & \Gamma_t = \partial\Omega \setminus (\Gamma_i \cup \Gamma_o)
\end{aligned}$$

The exact solution of the system (A1)-(A5) can be obtained in a straightforward manner and we have:

$$\vec{u} \equiv (0,0,1) \equiv \vec{e}_3$$

The mesh is structured, contains $5 \times 5 \times 7$ vertices equally reparted on each edge. The finite elements are prisms whose triangular basis is parallel to $x_1 O x_2$ and they are obtained by cutting each square of the 5×5 bidimensional mesh into two parts (cf. Figure A1).

2) Prismatic finite element conforming in $H(\operatorname{curl})$.

We detail now the choice of the function space proposed by NEDELEC [unpublished], that plays relatively to the prism the same role than the space R_1 for tetrahedrons (cf. Definition 3.4). We restrict ourselves to the "unity prism" \hat{K} :

$$\hat{K} = \left\{ (x_1, x_2, x_3) \in \mathbb{R}^3, 0 \leq x_i \leq 1, x_1 + x_2 \leq 1 \right\}$$

Then the procedure explained in (3.7) (Definition 3.5) can be applied without modification for any given prism. The interpolate vector potential admits the following form:

$$\hat{\varphi}(\hat{x}) = \begin{bmatrix} a+cx_3 \\ b+dx_3 \\ 0 \end{bmatrix} + \begin{bmatrix} -(e+fx_3)x_2 \\ (e+fx_3)x_1 \\ 0 \end{bmatrix} + \begin{bmatrix} 0 \\ 0 \\ \alpha+\beta x_1+\gamma x_2 \end{bmatrix}$$

$$\text{for } \hat{x} = (x_1, x_2, x_3) \in \hat{K}.$$

and depends on the nine real parameters $a, b, c, d, e, f, \alpha, \beta, \gamma$. The corresponding degrees of freedom are the circulations

$$\sigma_a(\vec{\varphi}) = \int_a \vec{\varphi} \cdot d\vec{s} \quad , \quad a \text{ edge of the mesh}$$

as previously and it is an exercise to show that the corresponding finite element associated with that choice of geometry, degrees of freedom and function space is unisolvent and conforming in $H(\text{curl})$.

3) Surfacic gauge.

Due to the particularity of the boundary conditions (A3)-(A5), F.X. ROUX [41] developed a procedure to construct a particular tree $T_h(\Gamma)$ and consequently the space $Y_h(\Omega)$ of the functions $\vec{\zeta}_h$ such that

$$(A6) \quad \text{curl}_{\Gamma} \vec{\zeta}_h \cdot \vec{n} = \vec{u} \cdot \vec{n} \quad \text{on } \partial\Omega$$

This choice ensures that the homogeneous boundary condition (A5) is always satisfied. The result is presented on Figure A1: the tree $T_h(\Gamma)$ is composed by two sub-trees on each face Γ_i and Γ_o . The edges a such that $\sigma_a(\vec{\varphi})$ is not null a priori are represented with a double line. For more details, we refer to [41,19]. The computation of $\vec{\zeta}_h$ satisfying (A6) (or (5.15)) is easy after finding an optimal enumeration of the edges that transforms (A6) into a triangular system. Due to the (relatively) low cost of this step of the algorithm (compared with the next step; the order of the systems (A6) and (A7) are respectively 69 and 249 for our test problem) this procedure has not been compared with a direct Gaussian elimination.

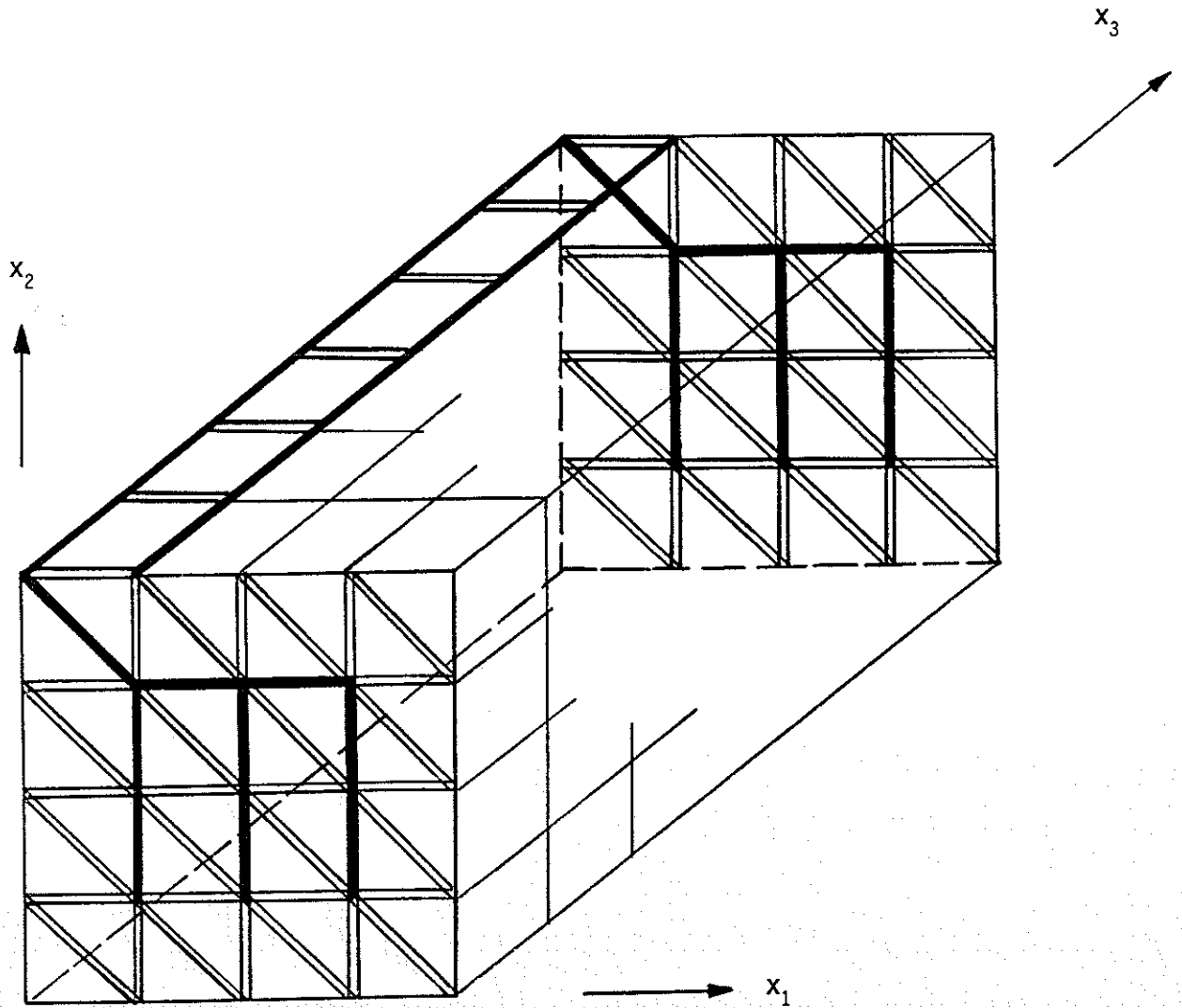

Figure A1. View of the surface tree $T_h(\Gamma)$ on the boundary of the cube $]0,1[^3$. The boundary edges, associated with the degrees of freedom that are a priori not null, are represented with a double line.

4) Solution of the internal problem.

We focus now on the computation of the stream function $\vec{\zeta}_h + \vec{\Psi}_h$ of the discrete velocity field, with $\vec{\zeta}_h$ given at the preceding section and $\vec{\Psi}_h \in K_h(\Omega)$ determined by solving the problem (5.18). We remark that this mixed problem can be rewritten in terms of the only vector potential $\vec{\Psi}_h$ according to Theorem 4.2 (but this is not the case for a general system such as (4.16)). Then the problem (5.18) is equivalent to

$$(A7) \quad \begin{cases} \vec{\Psi}_h \in K_h(\Omega) \\ \int_{\Omega} \text{curl} \vec{\Psi}_h \cdot \text{curl} \vec{\varphi}_h \, dx = - \int_{\Omega} \text{curl} \vec{\zeta}_h \cdot \text{curl} \vec{\varphi}_h \, dx \quad \forall \vec{\varphi}_h \in K_h(\Omega). \end{cases}$$

We recover (as in [18]) a classical conforming variational formulation. The matrix associated with (A7) is symmetric positive definite. We have used a conjugate gradient method (see e.g. LASCAUX-THEODOR [A1]) for solving the problem (A7). We have tested two preconditioners: the incomplete Cholesky factorization and the SSOR factorization of EVANS (see e.g. [A1]). The first has given negative roots during the algorithm with the choice of the internal tree $T_h(\Omega)$ pictured on the Figure A2. This fact proves that the matrix defined by (A7) is a priori not a M-matrix, according to MEIJERINK-VAN DER VORST [A2]. A performing choice for the preconditioner is finally the SSOR factorization that we retain in our present computation as well as for more complicated problems [18]. The discrete velocity field

$$\vec{u}_h = \text{curl} (\vec{\zeta}_h + \vec{\Psi}_h)$$

is in fact the exact solution \vec{e}_3 because the latter is belonging into the affine space $\text{curl} (\vec{\zeta}_h + K_h(\Omega))$ as we verified numerically. We emphasize that the discrete vector potential $\vec{\zeta}_h + \vec{\Psi}_h$ has not any elementary analogous and in particular it has no simple relation with the following family of the polynomial vector potentials $\vec{\Psi}_p$:

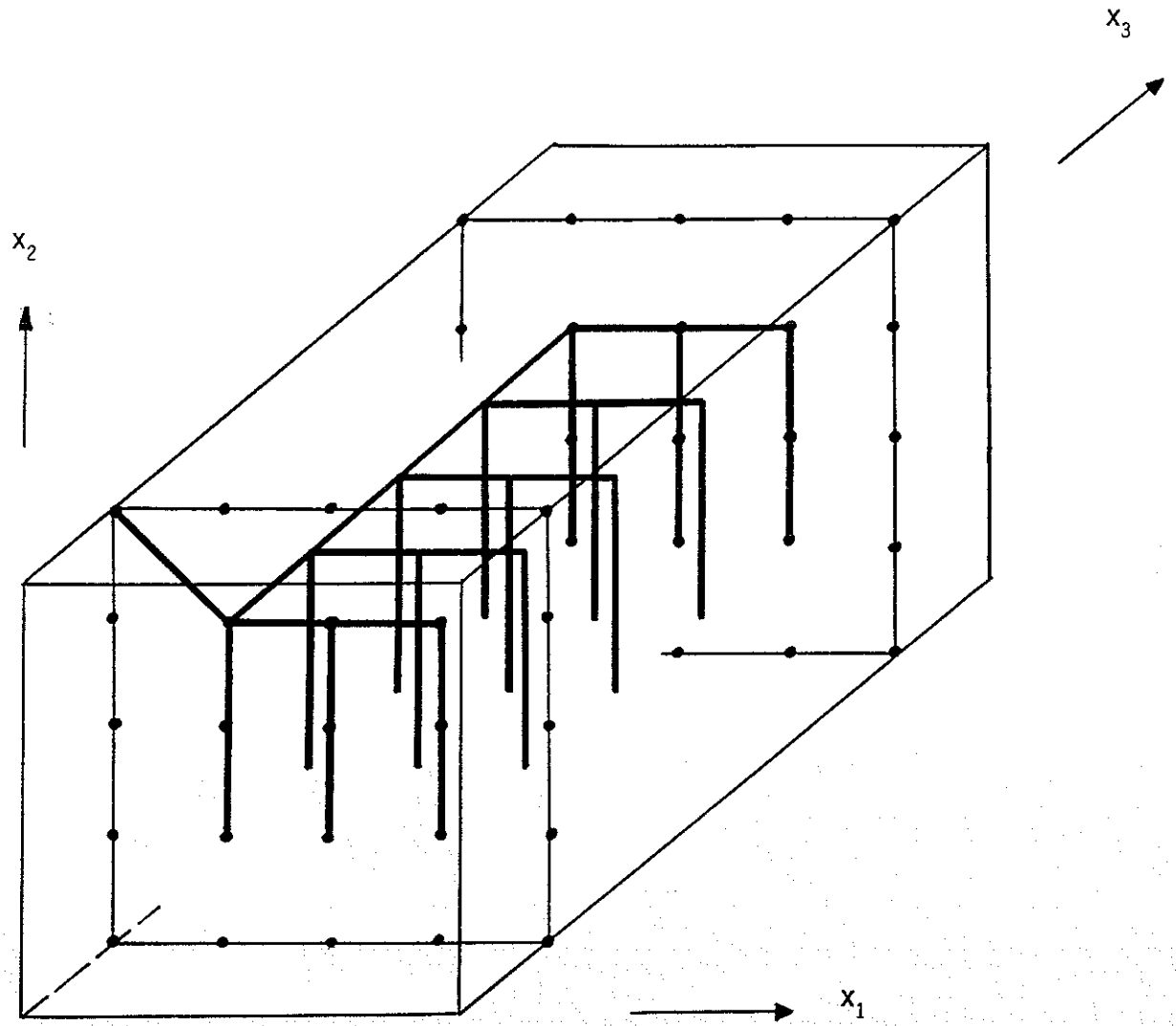

Figure A2. First choice for the internal tree $T_h(\Omega)$ inside the domain.

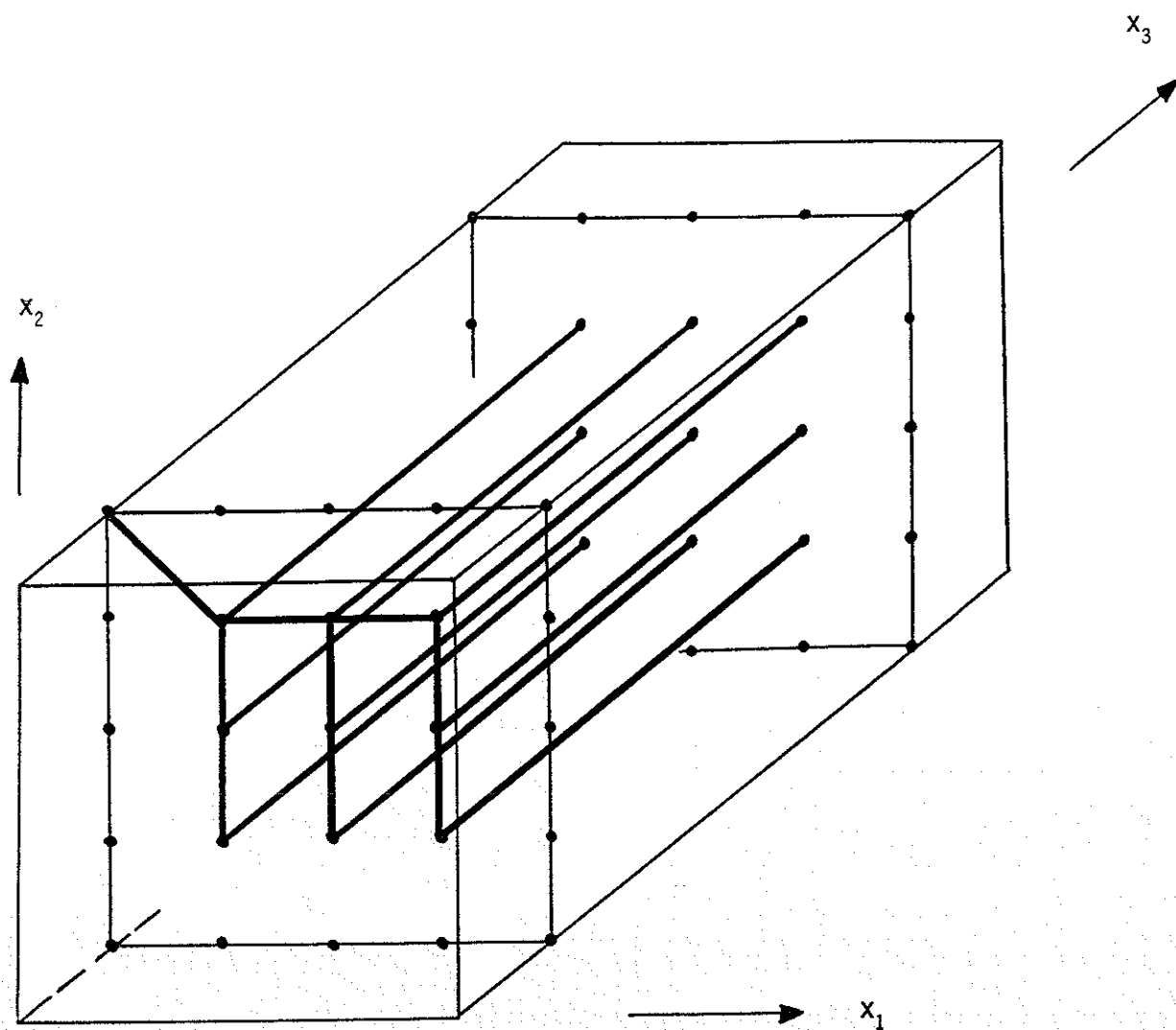

Figure A3. Second choice for the internal tree $T_h(\Omega)$ inside the domain.

$$\vec{\Psi}_p = \frac{1}{2} \vec{e}_3 \otimes \vec{x} \otimes \vec{x} + \text{grad } \phi, \quad \phi \text{ polynomial.}$$

We end this Annex with a comparison between the use of the two internal trees of Figures A2 and A3. The first tree is composed with a majority of horizontal edges when the second contains essentially vertical edges. The first (Figure A2) leads to a better performance for the conjugate gradient algorithm (40 iterations with the SSOR preconditioner to reach a relative error of 10^{-4} relatively to the operator l^2 norm, 74 with the second tree). Curiously the condition numbers $\lambda_{\max}/\lambda_{\min}$ of the two matrices are respectively 14150 (first tree) and 6811 (second tree). This last numerical result shows the great complexity of the repartition of the eigenvalues in the spectrum, according to JENNINGS [A3]. We have also tested in [19] other possibilities for the tree $T_h(\Omega)$ but no simple correlation appears between the geometrical location of the edges in $T_h(\Omega)$ and the performance of the conjugate gradient algorithm. (cf. also Remark 4.1). Nevertheless in all the practical situations that we have been confronted with ([18,19,41]), the linear system (A7) has been solved efficiently with the SSOR preconditioner.

ACKNOWLEDGMENTS

I thank F.X. ROUX and J.M. DUPUY for their intense collaboration during the implementation of the NEDELEC's $H(\text{curl})$ finite element, G. LAUMON for an helpful discussion about algebraic topology and the first Referee for his useful comments and suggestions.

REFERENCES

- [1] ADAMS R.A., *Sobolev Spaces*, Academic Press, New York, 1975.
- [2] BABUSKA I., Error Bound for the Finite Element Method, *Numer. Math.*, 16, pp 322-333, 1971.
- [3] BENDALI A., *Approximation par éléments finis de surface de problèmes de diffraction des ondes électromagnétiques*, Thèse d'Etat, Paris 6 univ, Paris, 1984.
- [4] BENDALI A., *Numerical Analysis of the Exterior Boundary Value Problem for the time Harmonic Maxwell Equations by a Boundary Finite Element Method. Part 1 The Continuous Problem*, *Math of Comp* 43, n° 167, pp 29-46, 1984.
- [5] BENDALI A., *Part 2 The Discrete Problem*, *Math of Comp* 43, n° 167, pp 47-68, 1984.
- [6] BENDALI A., DOMINGUEZ J.M., GALLIC S., *A Variational Approach for the Vector Potential Formulation of the Stokes and Navier-Stokes Problems in Three Dimensional Domains*, *J. of Math Anal and Appl* vol. 107, n° 2, pp537-560, 1985.
- [7] BENDALI A., GALLIC S., *Formulation du système de Stokes en potentiel vecteur*, Internal Report n° 79, Centre de Math. Appl. de l'Ecole Polytechnique, Palaiseau, 1982.
- [8] BERGE C., *Graphes et Hypergraphes*, Dunod, Paris, 1970 (english translation North Holland, 1973).
- [9] BERNARDI C., *Méthodes d'Elements Finis Mixtes pour les Equations de Navier Stokes*, Thèse de 3ème cycle, Paris 6 univ, Paris, 1979.
- [10] BRAMBLE J.H., HILBERT S.R., *Bounds for a Class of Linear Functionals with Applications to Hermite Interpolation*, *Numer. Math.* 16, pp 362-369, 1971.
- [11] BREZZI F., *On the existence, uniqueness and approximation of saddle point problems arising from Lagrangian multipliers*, *Rairo R2*, pp 129-151, 1974.
- [12] BREZZI F., DOUGLAS J., MARINI L.D., *Two Families of Mixed Finite Elements for Second Order Elliptic Problems*, *Numer. Math.* 47, pp 217-235, 1985.
- [13] CHOQUET-BRUHAT Y., *Géométrie Différentielle et Systèmes Extérieurs*, Dunod, Paris, 1968.
- [14] CIARLET P.G., *The finite Element Method for Elliptic Problems*, North Holland, Amsterdam, 1978.

- [15] COURANT R., FRIEDRICHS K.O., Supersonic Flow and Shock Waves, Interscience, New York, 1948.
- [16] DE RHAM G., Variétés Différentiables, Hermann, Paris, 1955.
- [17] DOMINGUEZ J.M., Thèse de 3ème cycle, Paris 6 University, Paris, 1982.
- [18] DUBOIS F., DUPUY J.M., *A Three Dimensional Vector Potential Formulation for Solving Transonic Flows with Mixed Finite Elements in 6° International Symposium : Finite Element Methods in Flow Problems*, Antibes, France, 1986.
- [19] DUBOIS F., Quelques problèmes liés au calcul d'écoulements de fluides parfaits dans les tuyères, Thèse de l'Université Paris 6, 1988.
- [20] DUVAUT G., LIONS J.L., Les inéquations en mécanique et en physique, Dunod, Paris, 1972.
- [21] EL DABAGHI F., PIRONNEAU O., *Stream Vectors in Three Dimensional Aerodynamics*, Numer. Math. 48, pp 561-589, 1986.
- [22] FOIAS C., TEMAM R., *Remarques sur les équations de Navier-Stokes stationnaires et les phénomènes successifs de bifurcation*, Ann Scuola Norm Sup Pisa, S IV, vol. V, n° 1, pp 29-63, 1978.
- [23] FRIEDRICHS K.O., *Differential Forms on Riemannian Manifolds*, Comm. Pure Appl. Math. 8, pp 551-590, 1955.
- [24] GEORGESCU V., *Some Boundary Value Problems for Differential Forms on Compact Riemannian Manifolds*, Ann di Math Pura et Appl., série 4, 122, pp 159-198, 1979.
- [25] GERMAIN P., MULLER P., Introduction à la mécanique des milieux continus, Masson, Paris, 1980.
- [26] GIRAULT V., RAVIART P.A., Finite Element Methods for Navier Stokes Equations. Theory and Applications, Springer Verlag, Berlin, 1986.
- [27] GLIMM J., Personal communication, 1986.
- [28] GUSTAFSON K., HARTMAN R., *Divergence Free Bases for Finite Element Schemes in Hydrodynamics*, SIAM J. Numer. Anal., vol 20 n° 4, pp 697-721, 1983.
- [29] HECHT F., *Construction d'une base de fonctions P_1 non conforme à divergence nulle dans \mathbb{R}^3* , RAIRO Analyse Numérique vol. 15, pp 315-341, 1980.
- [30] JACKSON J.D., Classical Electrodynamics, John Wiley & sons, New York, 1962.

- [31] LENOIR M., *Optimal Isoparametric Finite Elements and Error Estimates for Domains Involving Curved Boundaries*, SIAM J. Numer. Anal., vol 23 n° 3, pp 562-580, 1986.
- [32] LIONS J.L., MAGENES E., *Problèmes aux limites non homogènes et applications*, vol 1, Dunod, Paris, 1968.
- [33] MASSEY W.S., *Algebraic Topology : an Introduction*, Harcourt, Brace & World, Inc, New York, 1967.
- [34] NEDELEC J.C., *Curved Finite Element Methods for the Solution of Singular Integral Equations on Surfaces in \mathbb{R}^3* , Comp. Meth. in Appl. Mech. and Engineering 8, pp 61-80, 1976.
- [35] NEDELEC J.C., *Approximation des équations intégrales en mécanique et en physique*, Cours CEA-EDF-INRIA, Paris, 1977.
- [36] NEDELEC J.C., *Computation of Eddy Currents on a Surface in \mathbb{R}^3 by Finite Element Methods*, SIAM J. Numer. Anal., vol 15, pp 580-594, 1978.
- [37] NEDELEC J.C., *Mixed Finite Elements in \mathbb{R}^3* , Numer. Math. 35, pp 315-341, 1980.
- [38] NEDELEC J.C., *Eléments finis mixtes incompressibles pour l'équation de Stokes dans \mathbb{R}^3* , Numer. Math. 39, pp 97-112, 1982.
- [39] NEDELEC J.C., *A New Family of Mixed Finite Elements in \mathbb{R}^3* , Numer. Math. 50, pp 57-81, 1986.
- [40] RAVIART P.A., THOMAS J.M., *A Mixed Finite Element Method for Second Order Elliptic Problems*, in Lect. Notes in Math. n° 606, Springer Verlag, Berlin, 1977.
- [41] ROUX F.X., Lecture at Paris 6 University, march 1984, and Thesis, to appear.
- [42] SCOTT R., *Interpolated Boundary Conditions in the Finite Element Method*, SIAM J Numer Anal, vol 12, n° 3, pp 404-427, 1975.
- [43] TEMAM R., *Navier Stokes Equations*, North Holland, Amsterdam, 1977.
- [44] TREVES F., *Introduction to Pseudodifferential and Fourier Integral Operators*, vol 2, Plenum Press, New York, 1980.
- [45] ZLAMAL M., *Curved Elements in the Finite Element Method I*, SIAM J, Numer. Anal, vol 10, n° 1, pp 229-240, 1973.
- [46] ZLAMAL M., *Curved Elements in the Finite Element Method II*, SIAM J, Numer. Anal, vol 11, n° 2, pp 347-362, 1974.

- [A1] LASCAUX P., THEODOR R., Analyse numérique matricielle appliquée à l'art de l'ingénieur, Masson, Paris, 1986.
- [A2] MEIJERINK J.A., VAN DER VORST H.A., An Iterative Solution Method for Linear Systems of Which the Coefficient Matrix is a Symmetric M-Matrix, *Math. of Comp.*, 31, n° 137, pp 148-162, 1977.
- [A3] JENNINGS A., Influence of the Eigenvalue Spectrum on the Convergence Rate of the Conjugate Gradient Method, *J. Inst. Maths. Applics.*, 20, pp 61-72, 1977.