



A SURVEY OF V2V CHANNEL MODELING FOR VANET SIMULATIONS

H. Boeglen¹, B. Hilt¹, J. Ledy², A-M. Poussard², R. Vauzelle²
and P. Lorenz¹

¹ Laboratoire MIPS, Université de Haute Alsace, France

² Laboratoire XLIM-SIC, UMR CNRS 6172, Université de Poitiers, France

WONS2011, Bardonecchia

Outline:

- 1 - Introduction
- 2 - Wireless channel modeling and characterization background
- 3 - V2V channel models
- 4 - Towards a realistic VANET simulator
- 5 - Conclusions

The VANET context:

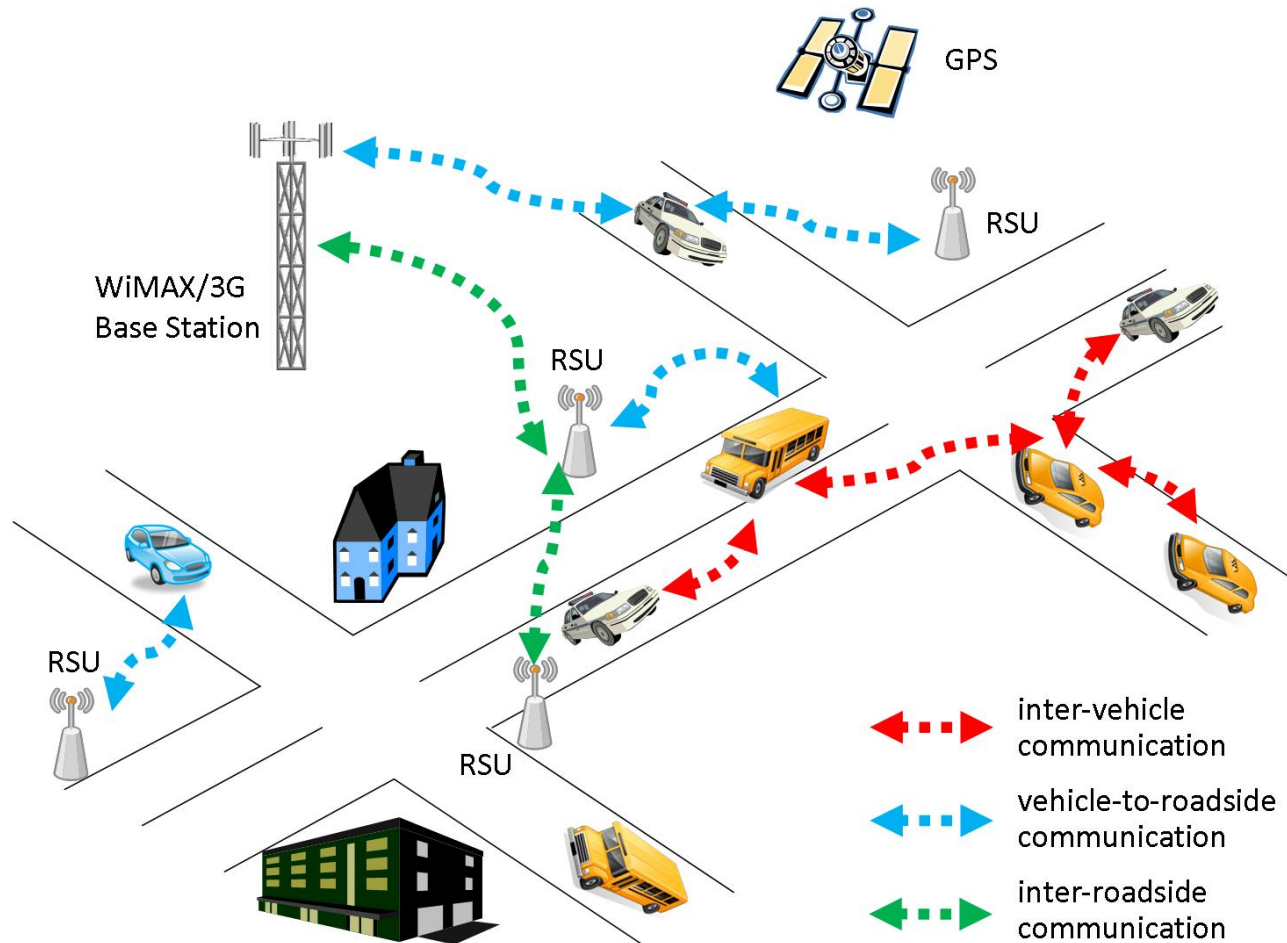

- ➔ Wireless communications at 5.9GHz using 802.11p physical layer.
- ➔ VANET simulations require accurate channels models.
- ➔ VANET channels exhibit specific characteristics: still a research issue.

Channel models fall into two classes:

Deterministic

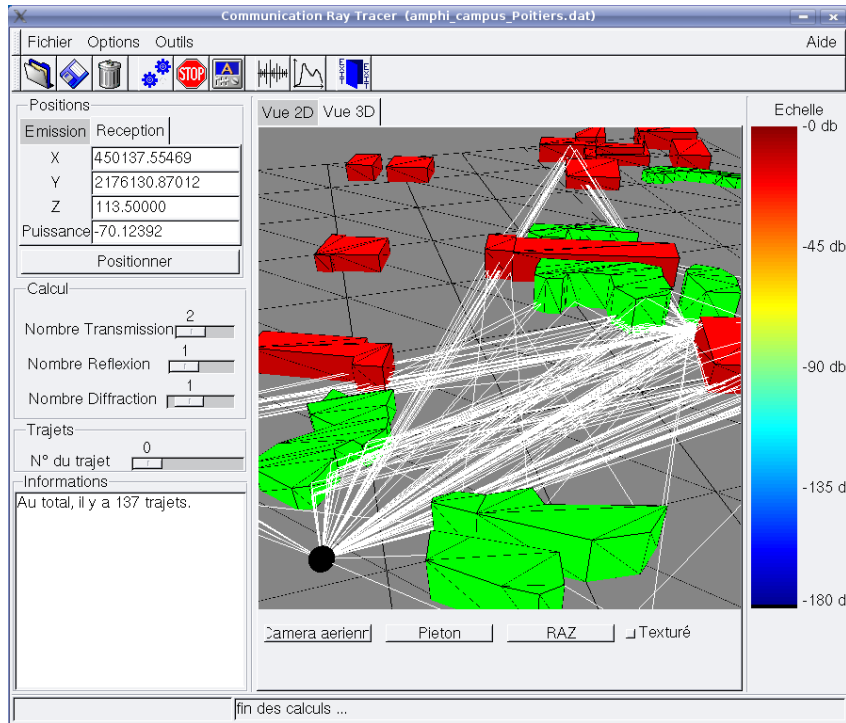

- Very realistic
- Require high computational times
- Site specific

Stochastic

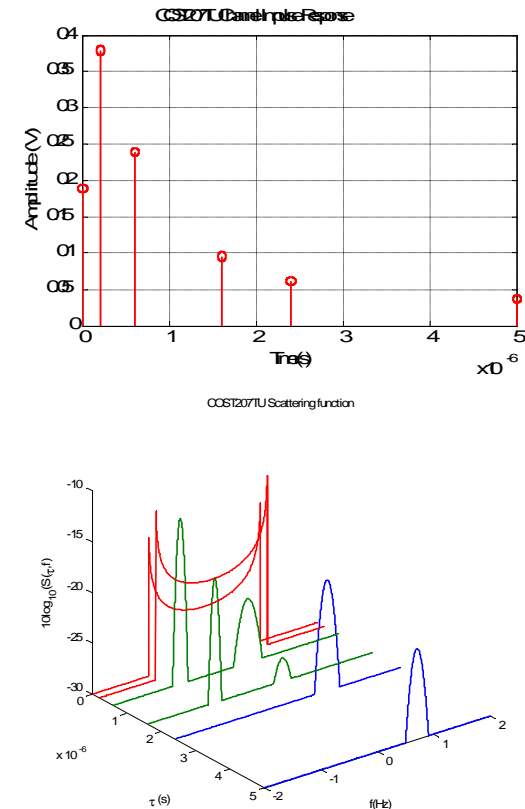

- Computationally efficient
- Emulate variations of the main channel effects

Main characteristics of mobile wireless channels:

Multipath propagation:

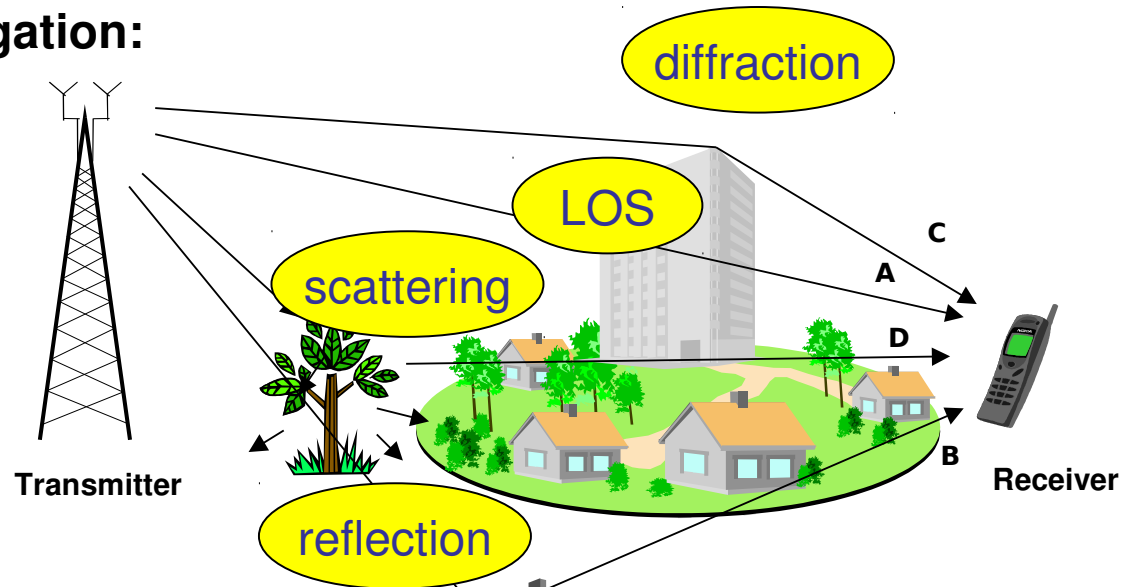

$h(\tau)$

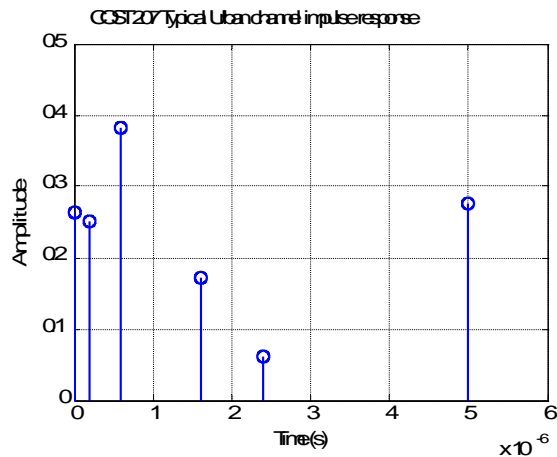

FT

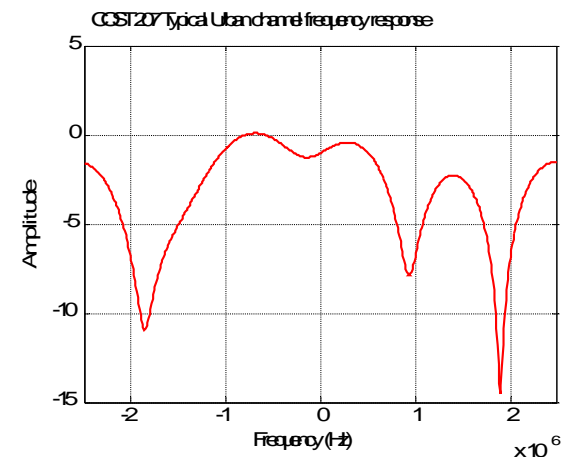

Distortion of the spectrum of the transmitted signal

Doppler effect:

$$f_n = f_{\max} \cdot \cos(\alpha_n)$$

$$f_{\max} = \frac{v}{c_0} \cdot f_0$$

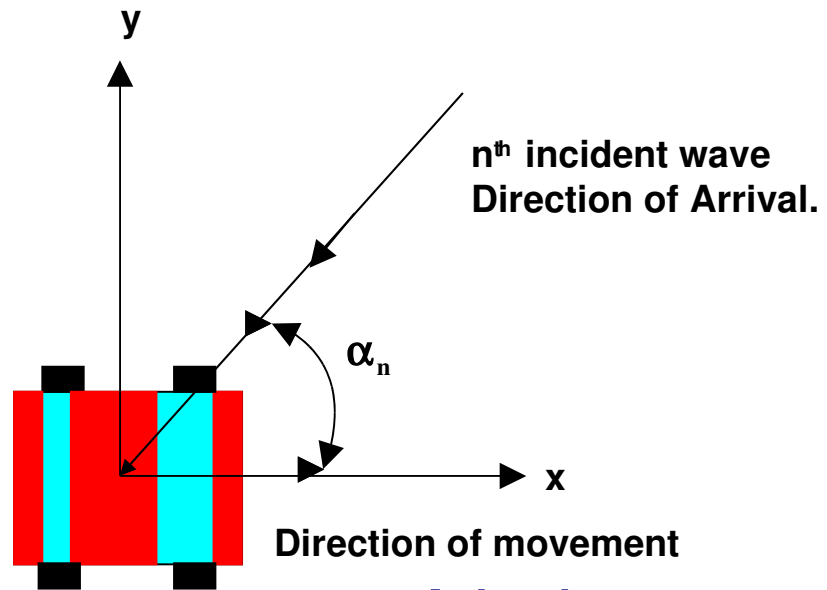

$S(\tau, \nu)$

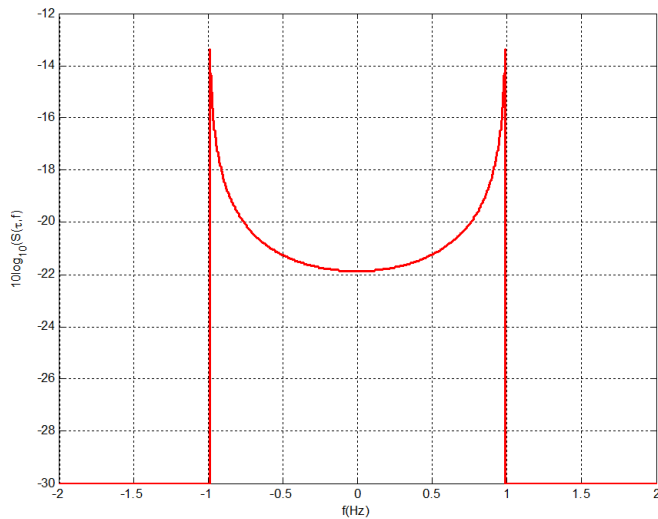

$h(\tau, t)$

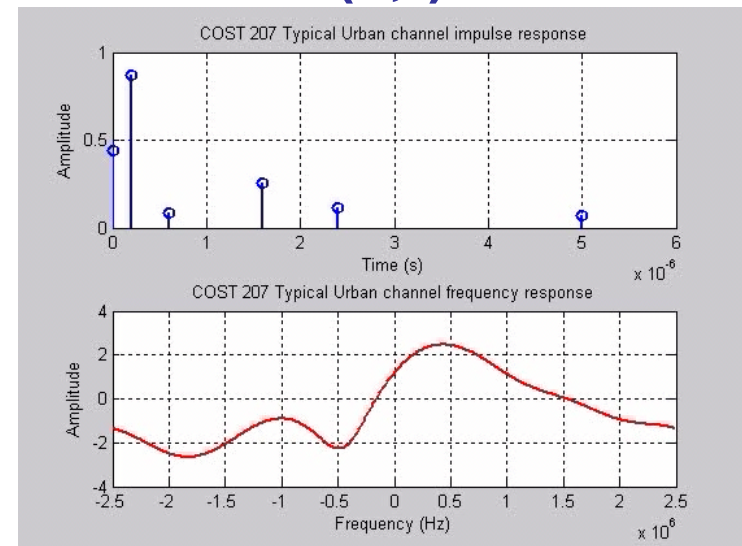

Consequences on the transmitted signal:

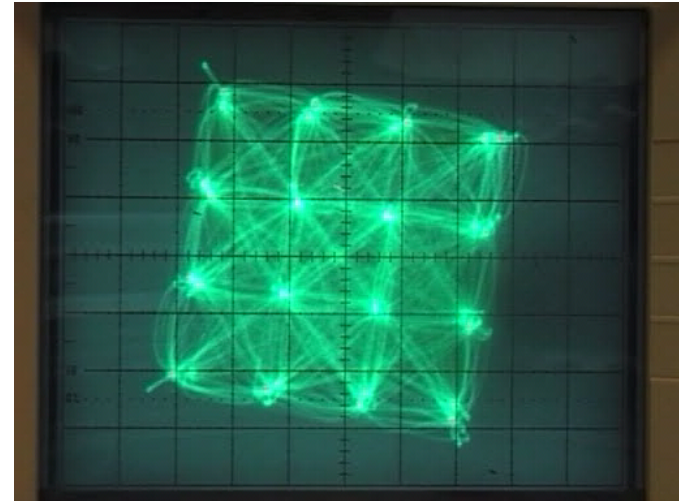
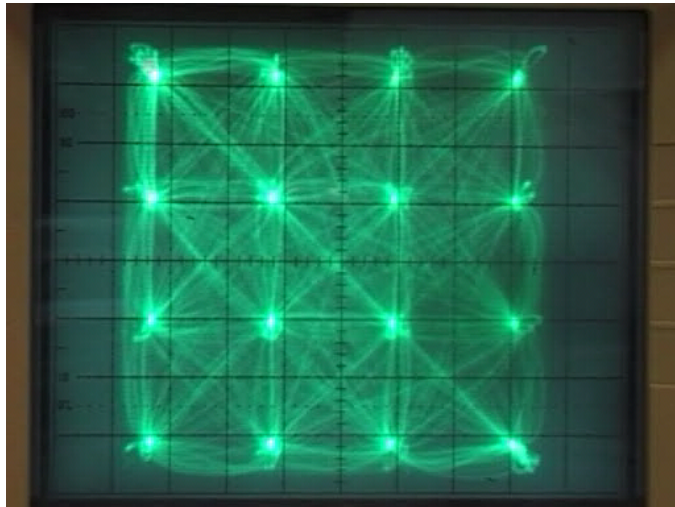
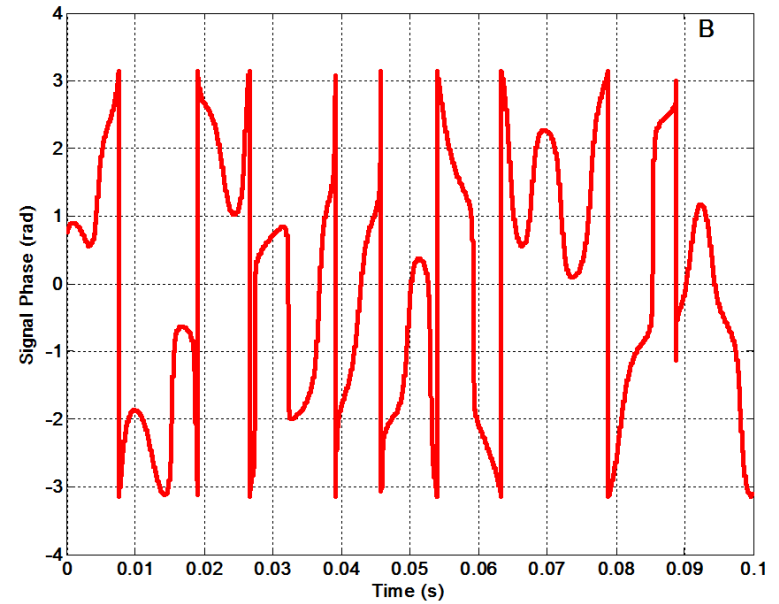
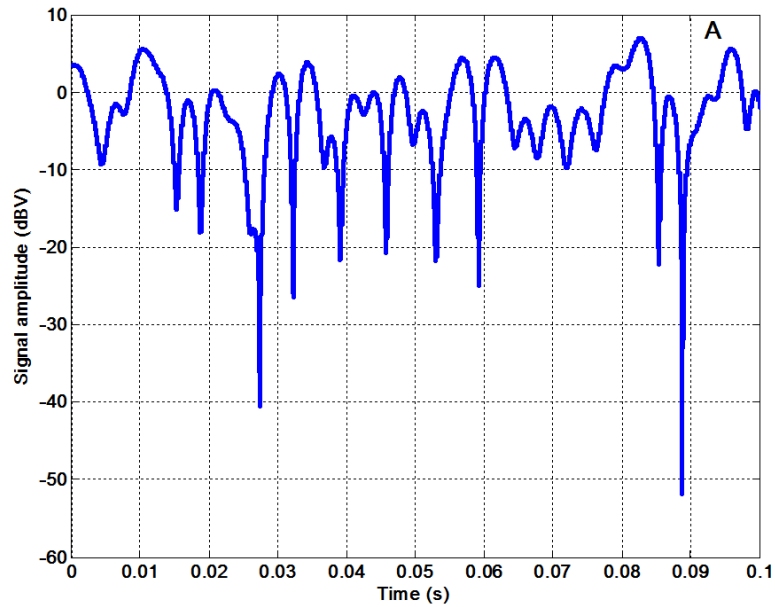

Characterization of the frequency and time selectivities

→ Coherence bandwidth = frequency band on which the channel is non frequency selective:

$$B_c \approx 0.2/\tau_{\text{RMS}}$$

If $B_c \gg B$ the system bandwidth → Narrowband system (i.e. non frequency selective channel)

If $B_c \ll B$ the system bandwidth → wideband system (i.e. frequency selective channel)

→ Coherence time = amount of time during which the channel parameters are stable:

$$T_c \approx 1/f_{\text{Dmax}}$$

Theoretical framework

→ Linear stochastic process → linear filter

→ WSS and US assumptions

Implementation of a wideband stochastic channel model

The Tapped Delay Line (TDL) structure

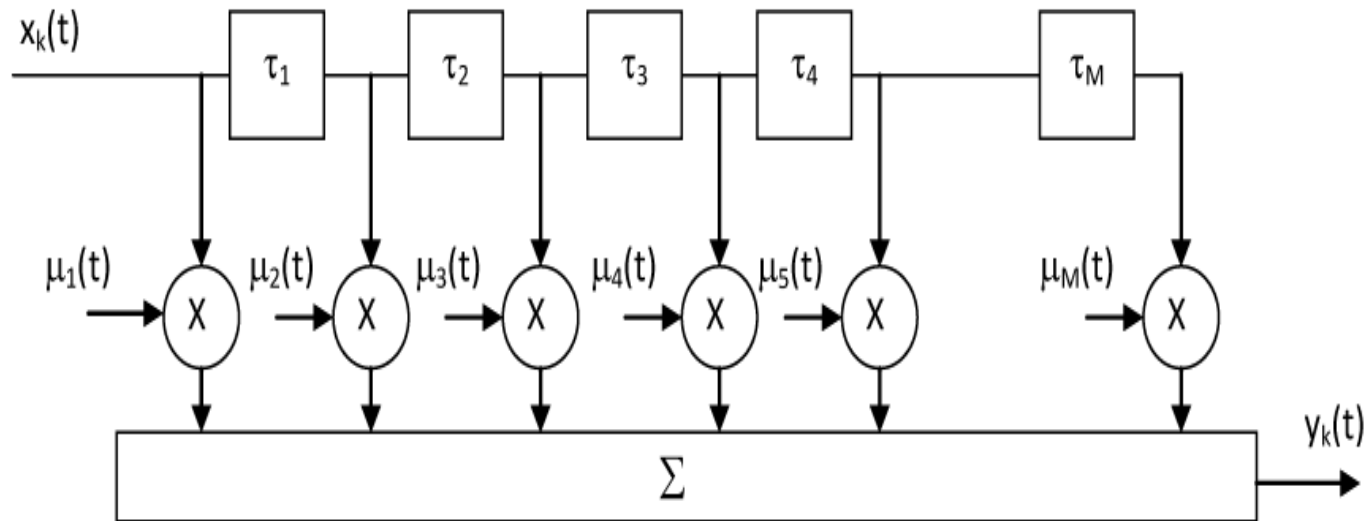

$X_k(t)$: input of the channel

$Y_k(t)$: output of the channel

$\mu_k(t) = \alpha_k(t) \cdot e^{j\phi_k(t)}$ generated according to an amplitude ($\alpha_k(t)$ e.g. Rayleigh) and phase ($\Phi_k(t)$ e.g. uniform) statistical distributions

$\mu_k(t)$ passed into a filter whose shape is obtained from the scattering function $S(\tau, \nu)$ \rightarrow taking into account the Doppler effect

Main characteristics

- TX and RX are at the same height (AOD, AOA, Doppler shape)
- TX and RX and many scatterers are moving (WSSUS assumption no longer valid)
- V2V communications operate in the 5GHz band (higher signal attenuation)
- Propagation environments:
 - Highways: 2 to 6 lanes, speed from 25m/s, different traffic densities
 - Rural streets: 2 lanes, speeds up to 30m/s, few buildings, low traffic density
 - Suburban streets: one or two lanes, speed 15m/s or less, low traffic density
 - Urban streets: wider streets and higher traffic density than suburban streets
- **Three simulation-ready V2V channel models**

1. Channel models used by the 802.11p working group

→ Environments



FIGURE 1 The six environments: (a) V2V—Expressway oncoming. (b) V2V—Urban canyon oncoming. (c) RTV—Suburban street. (d) RTV—Expressway in same direction with wall. (e) RTV—Urban canyon. (f) RTV—Urban canyon.

1. Channel models used by the 802.11p working group

→ Traditional TDL WSSUS models

TABLE 2 V2V Channel Models for the Six Scenarios

Tap No.	Path No.	Tap Power (dB)	Relative Path Loss (dB)	Delay Value (ns)	Rician K (dB)	Frequency Shift (Hz)	Fading Doppler	LOS Doppler (Hz)	Modulation (Hz)	Fading Spectral Shape
1	1	0.0	[0.0, -1.8, 0.0, 0.0, 0.0, -1.4]	0	[-1.6, 7.5, -5.3, 4.0, 3.3, 23.8]	[1451, 574, 769, 1145, 648, -55]	[60, 165, 70, 284, 152, 1407]	[1452, 654, 770, 1263, 635, -60]	Rician	Round
1	2	0.0	[-24.9, -30.5, -36.4, -17.6, -21.5, -5.6]	1	n/a	[884, -97, -22, 833, 171, -20]	[858, 543, 600, 824, 823, 84]	n/a	Rayleigh	[R, C3, R, R, R, R]
[1, 1, 1, 2, 2, 2]	3	[0.0, 0.0, 0.0, -10.0, -9.3, -11.2]	[-25.5, -25.1, -30.0, -12.9, -11.8, -14.2]	[2, 2, 2, 100, 100, 100]	[n/a, n/a, n/a, n/a, n/a, 5.7]	[1005, -89, 535, 707, 582, -56]	[486, 478, 376, 871, 249, 1345]	[n/a, n/a, n/a, n/a, n/a, 40]	[Y, Y, Y, Y, Y, I]	[R, C3, R, R, R, C3]

→ don't take into account the non-stationarity of the CIR

→ Don't take into account the correlation between taps

→ Some authors report this is the worst case situation

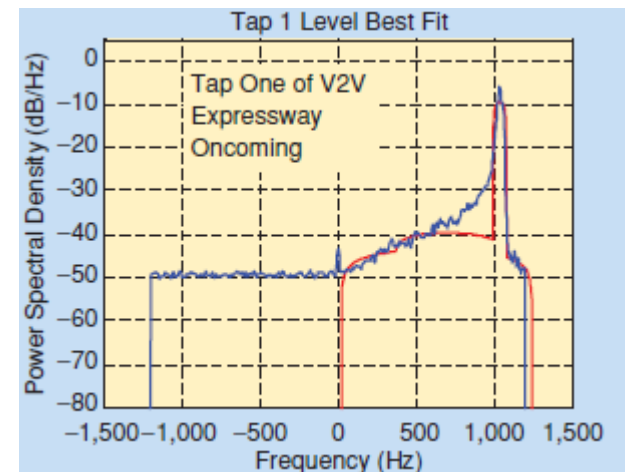

2. The Sen-Matolak implementation

→ Environments

Environment	RMS Delay spread (ns) [MIN ; MEAN ; MAX]
Urban area Inside Car (UIC)	[2.7; 236; 1210]
Urban area Outside Car (UOC)	[3; 125.8; 1328.6]
Open area Low Traffic density (OLT)	[0.3; 53.2; 1113.4]
Open area High Traffic density (OHT)	[0.5; 128.6 1773.4]
Small city (SMALL)	[0.7; 160; 1276]



2. The Sen-Matolak implementation

➔ Taking into account the non-stationarity of the CIR and the correlation between taps:

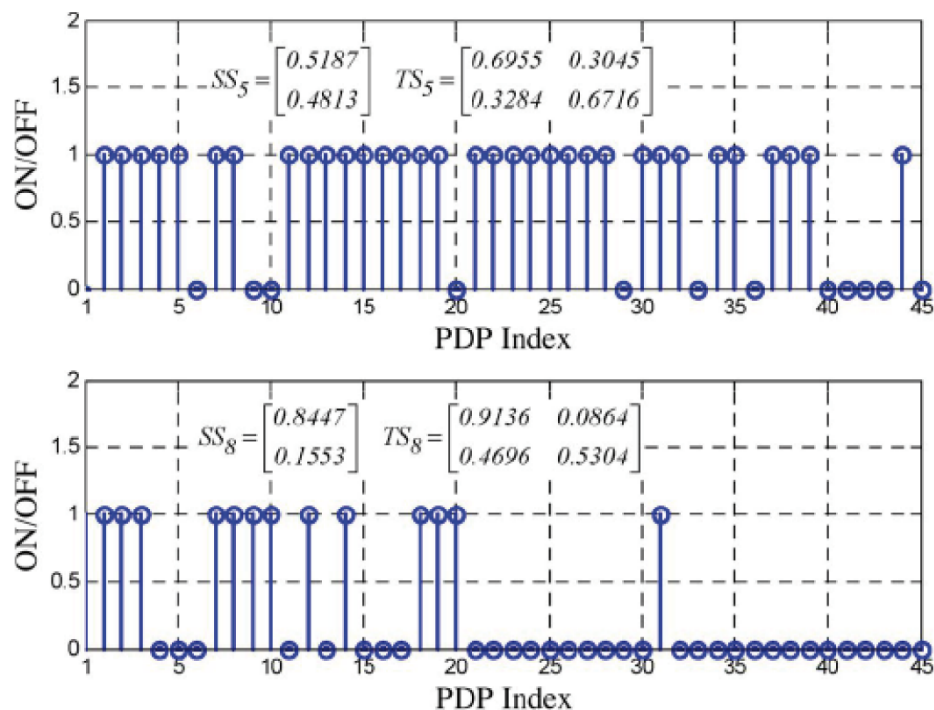

TABLE VII
CORRELATION MATRICES FOR 10- AND 5-MHz CHANNELS FOR UOC
(LOWER TRIANGULAR PART: 10 MHz, UPPER TRIANGULAR PART: 5-MHz)

i, j	1	2	3	4
1	1.00	0.7243	0.5528	NA
2	0.6898	1.00	0.5260	NA
3	0.6518	0.4922	1.00	NA
4	0.5772	0.5142	0.8479	1.00

TABLE VIII
CORRELATION MATRICES FOR 10- AND 5-MHz CHANNELS
FOR SMALL CITY (LOWER TRIANGULAR PART: 10 MHz,
UPPER TRIANGULAR PART: 5-MHz)

i, j	1	2	3
1	1.00	0.0293	NA
2	0.0338	1.00	NA
3	0.6813	0.0684	1.00

TABLE IX
CORRELATION MATRICES FOR 10- AND 5-MHz CHANNELS FOR OHT
(LOWER TRIANGULAR PART: 10 MHz, UPPER TRIANGULAR PART: 5 MHz)

i, j	1	2	3
1	1.00	0.3953	NA
2	0.5441	1.00	NA
3	0.4157	0.1707	1.00

2. The Sen-Matolak implementation

→ Parameters for the 10MHz channels:

CHANNEL MODELS FOR 10-MHZ CHANNELS

TAP INDEX K	ENERGY	WEIBULL SHAPE FACTOR (β_K)	$P_{00,K}$	$P_{11,K}$	P_1
UOC					
1	0.88	3.19	NA	1.0000	1.0000
2	0.08	1.61	0.2717	0.9150	0.8956
3	0.03	1.63	0.4401	0.8171	0.7538
4	0.01	1.73	0.5571	0.7488	0.6382
SMALL CITY					
1	0.90	3.95	NA	1.0000	1.0000
2	0.08	1.91	0.4839	0.9446	0.9034
3	0.02	2.02	0.3452	0.7712	0.7383
OHT					
1	0.95	4.3	NA	1.0000	1.0000
2	0.04	1.64	0.3625	0.8366	0.7960
3	0.01	1.89	0.5999	0.6973	0.5696
OLT					
1	0.96	5.15	NA	1.0000	1.0000
2	0.04	1.63	0.3836	0.8525	0.8073
UIC					
1	0.756	2.49	NA	1.0000	1
2	0.120	1.75	0.0769	0.9640	0.9625
3	0.051	1.68	0.3103	0.8993	0.8732
4	0.034	1.72	0.3280	0.8521	0.8199
5	0.019	1.65	0.5217	0.7963	0.7017
6	0.012	1.6	0.6429	0.7393	0.5764
7	0.006	1.69	0.6734	0.6686	0.4971

→ Doppler effect taken into account by simple lowpass filtering

3. A MIMO Geometry-based Stochastic Channel Model (GSCM):

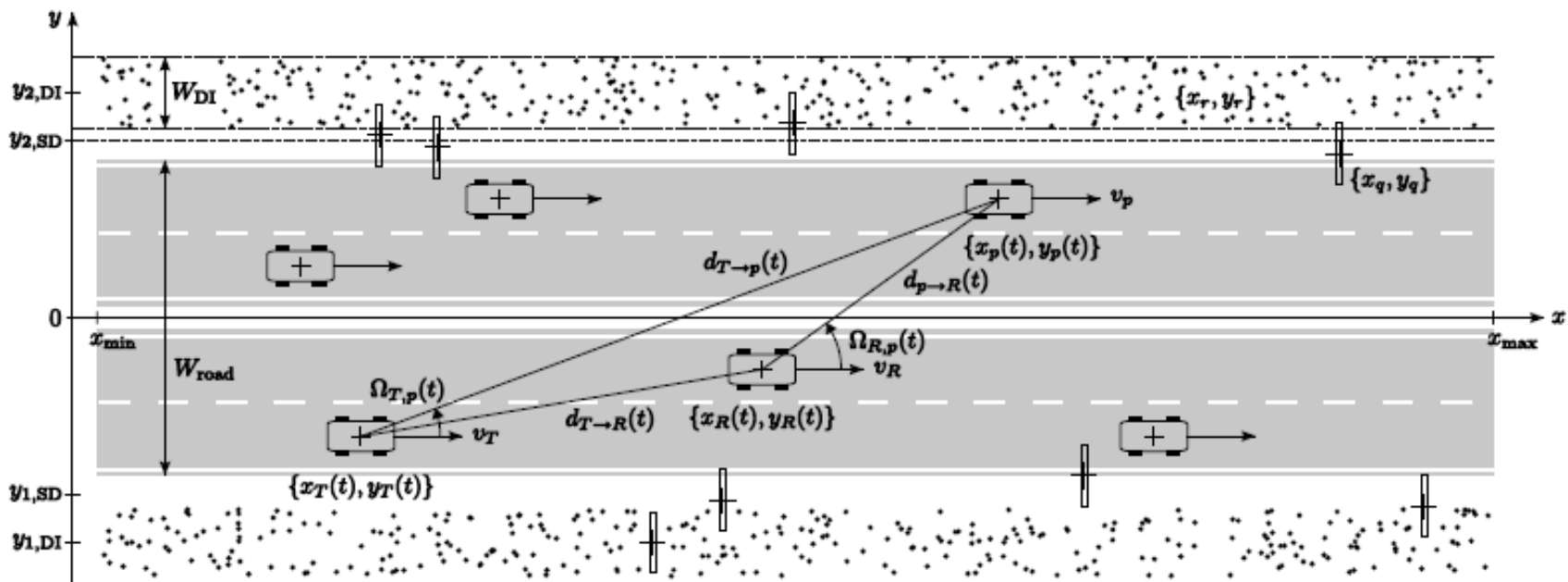

- Place scatterers with scattering properties at random in the scene
- Determine contributions of the scatterers by simplified ray-tracing
- Sum up the contributions at the receiver side

3. A MIMO Geometry-based Stochastic Channel Model (GSCM):

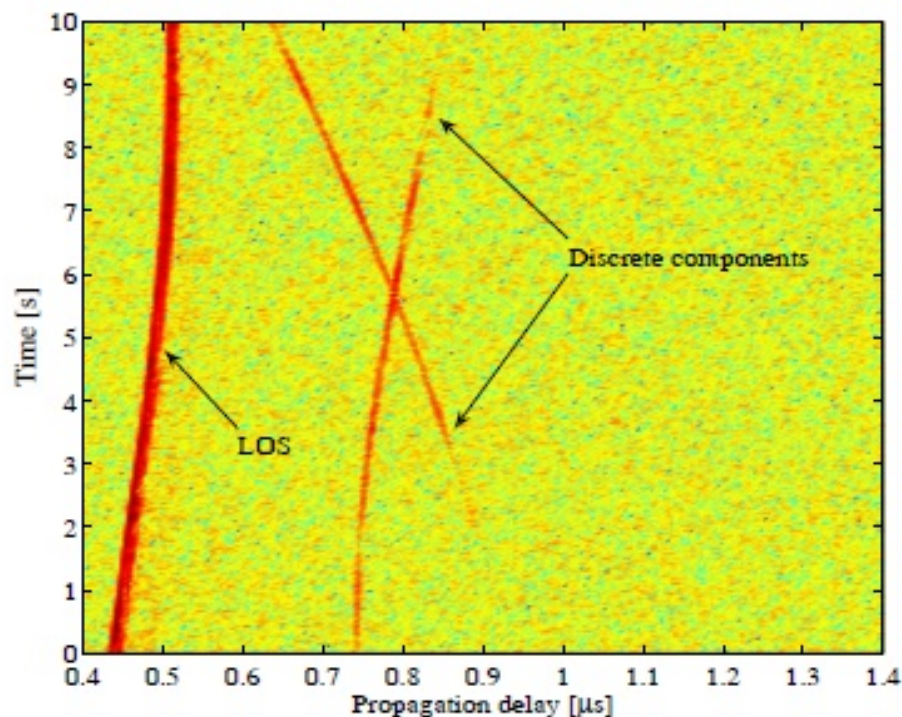

Measured CIR contains 4 parts:

LOS component

Discrete components, reflections from mobile scatterers

Discrete components, reflections from fixed scatterers

Diffuse components (environment along the roads)

- ➔ Natively MIMO (takes into account AOA and AOD)
- ➔ Handles non-WSSUS conditions and Doppler spectrum

1. UM-CRT a realistic channel model integrated into NS2

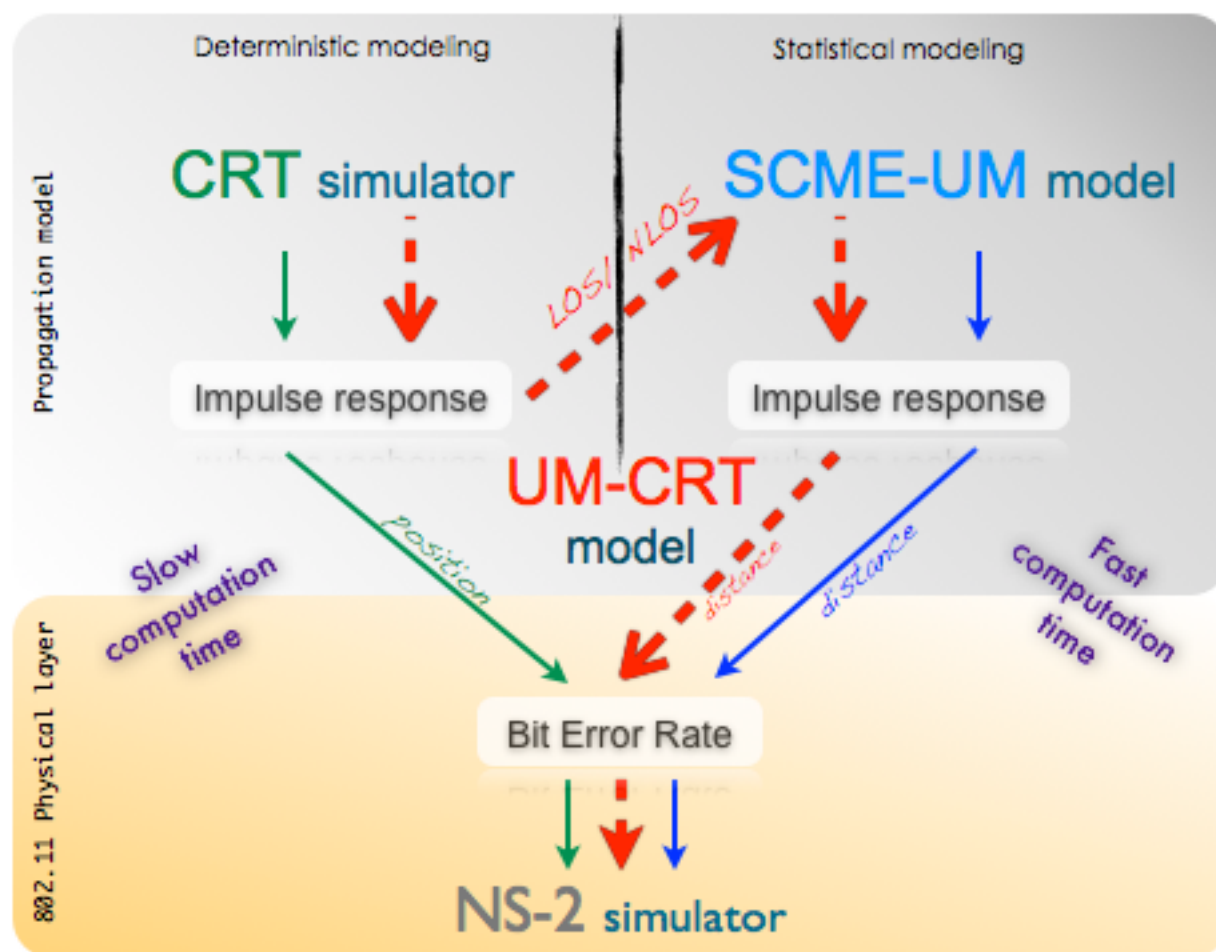

- ➔ Compromise between a deterministic simulator (high computational time) and a stochastic channel model (fast simulation).
- ➔ Combined with a realistic 802.11p physical layer

1. UM-CRT a realistic channel model integrated into NS2

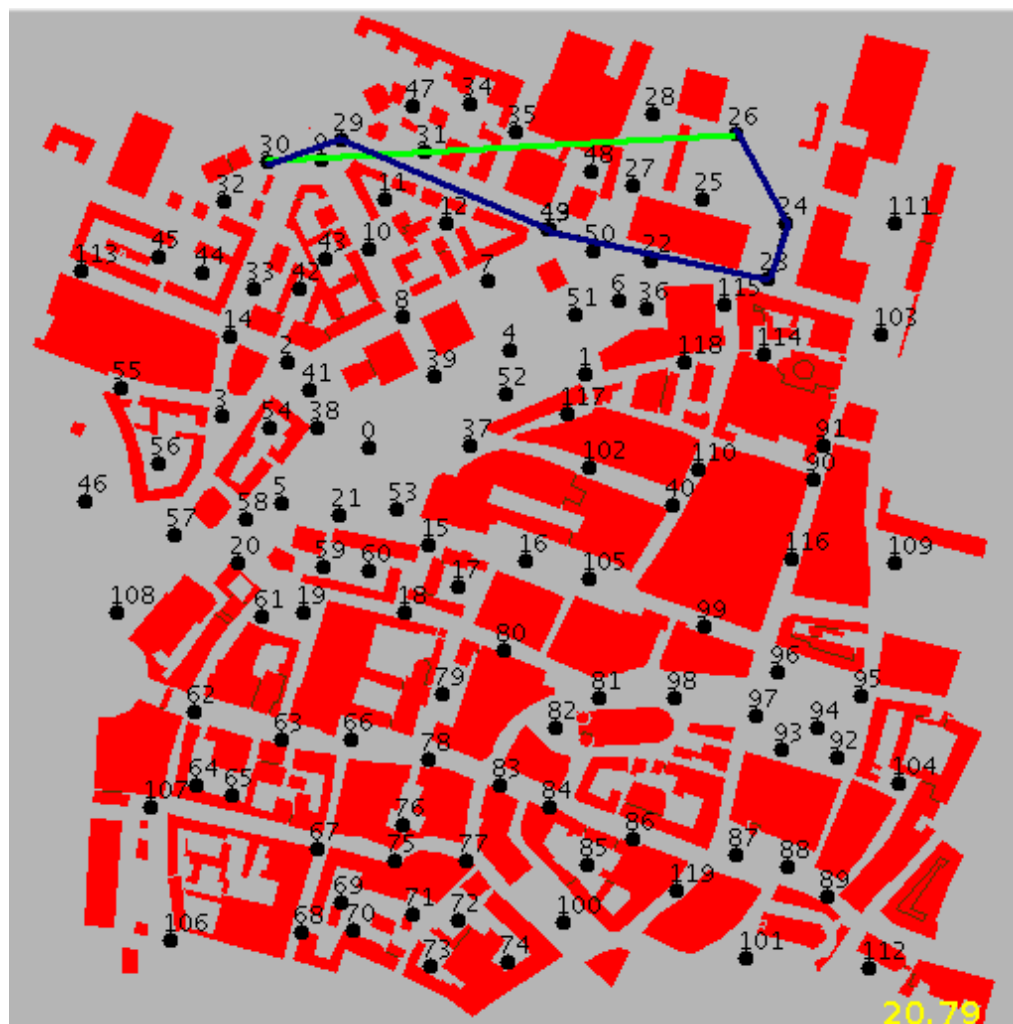

Example FreeSpace vs UM-CRT:

SISO, 120 nodes,
802.11p, 1 communication.

FreeSpace Propagation model
(1 Hop)

UM-CRT Propagation model
(5 Hops)

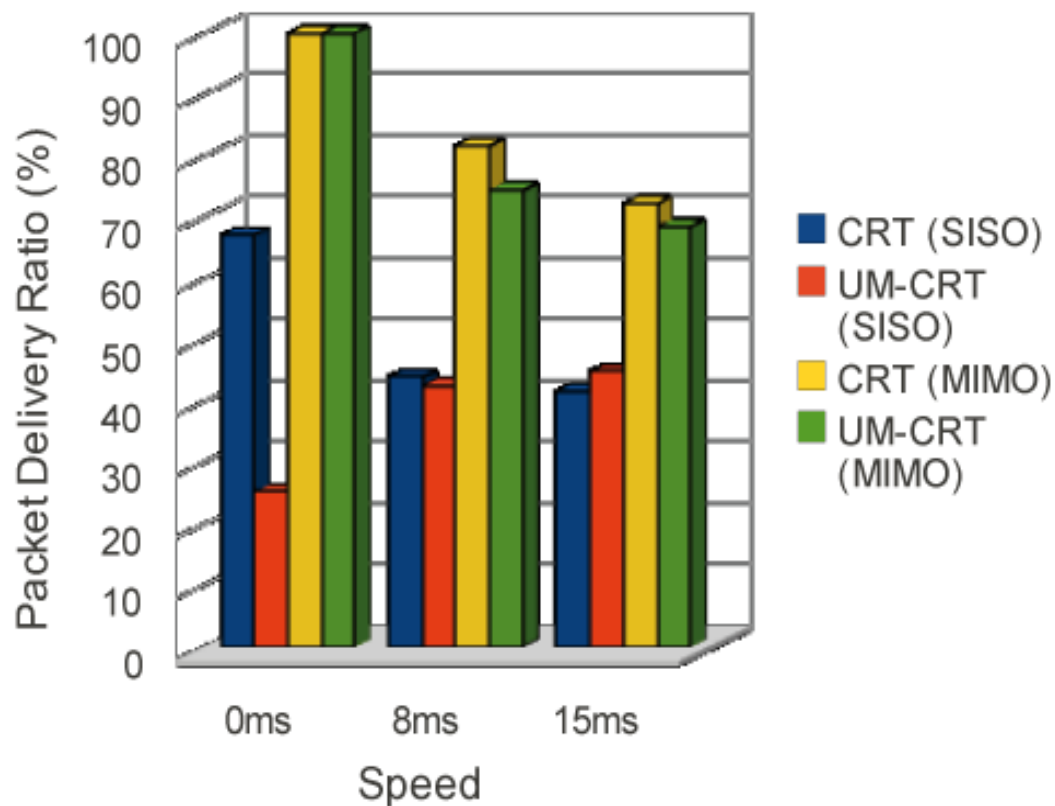

1. UM-CRT a realistic channel model integrated into NS2

→ Evaluation



- MIMO 2X2 (Alamouti scheme) improves the communication
- Have to find more relevant criteria to characterize the CIR
- Still quite high computational time

1. PhySimWiFi for NS3

Decentralized Systems and Network Services Research Group - TM & SCC

- Home
- News
- Staff
- Teaching
- Research
- Publications
- Traffic Telematics Junior Research Group
- ▾ Miscellaneous / Software
 - PhySimWiFi for NS-3
 - BitMON
 - JaaS Dispatcher
 - JAAS Dispatcher
 - EMDV Visualizer

PhySimWiFi for NS-3

Contact: [Jens Mittag](#), Stylianos Papanastasiou (CSS)

Project Group: DSN, Chalmers University of Technology - Signals and Systems (CSS)

Overview

PhySim-WiFi for [NS-3](#) is a detailed and accurate implementation of the OFDM-based IEEE 802.11 standard within the popular network simulator [NS-3](#). Compared to the default 802.11 PHY implementation of [NS-3](#), which abstracts packets by considering only an average signal strength per packet and the length of the packet, the PhySim-WiFi implementation simulates the underlying signal processing steps of a transceiver down to the signal level, and introduces an increase in accuracy for the decision whether a packet could be received correctly or not. At the same time, the new implementation allows to incorporate more sophisticated channel models. For instance, due to the modeling of packets on a signal level, channel models can emulate multi-path effects much more accurately and are able to reflect Doppler effects and their impact on the physical layer signal processing algorithm. The PhySim-WiFi implementation is a drop-in replacement of the default YansWifiPhy model, thus, it can be used with only minor modifications in the existing simulation code and the existing scenario setups.

For additional information, please have a look at the

- [PhySimWiFi Manual 1.0](#)

- ➔ Fully compliant 802.11p physical layer down to the channel estimation algorithms
- ➔ Includes 802.11p channel models

1. PhySimWiFi for NS3

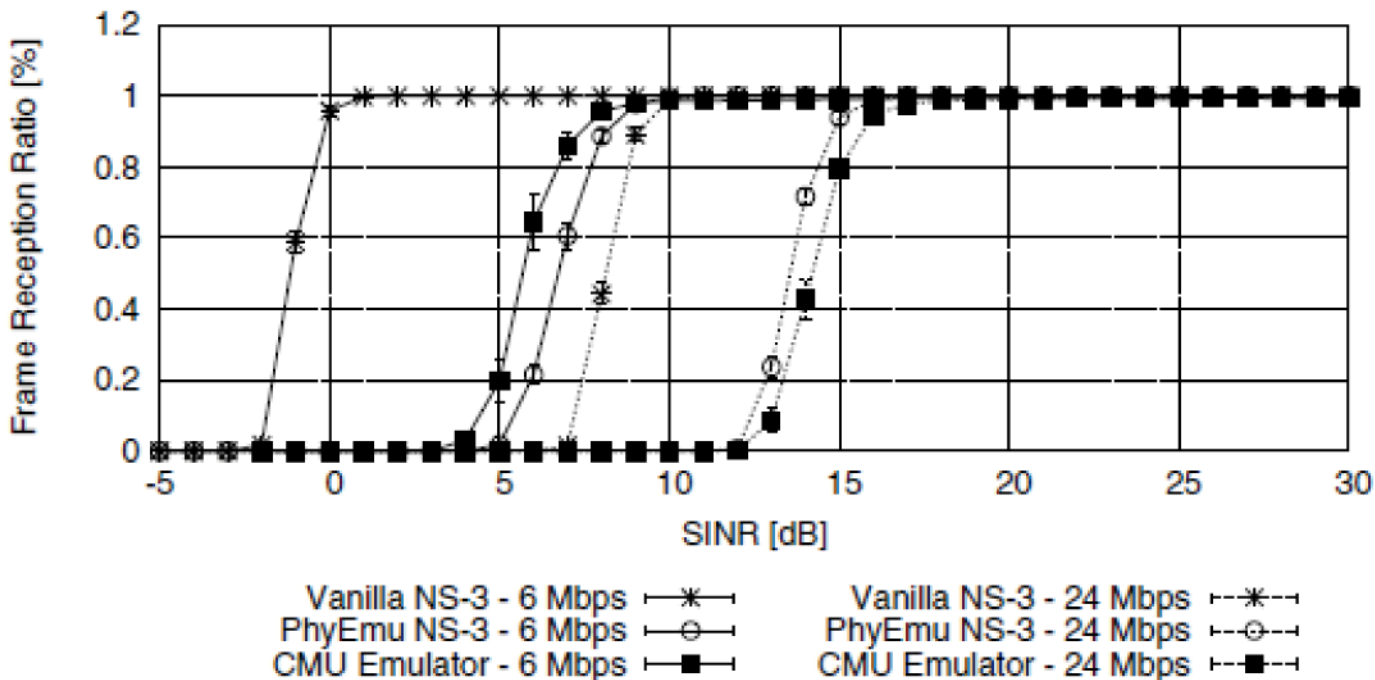

- ➔ Has been tested against real 802.11 Atheros chipsets (CMU network emulator)
- ➔ 7dB in SINR between plain vanilla NS3 and PhySimWiFi!

- To be accurate VANET simulators **HAVE TO** integrate realistic propagation models
- Stochastic channel models are computationally efficient and have proved to be very accurate (mobile telephony)
- Need for more measurement campaigns all over the world → to get the relevant parameters to parameterize the channel models
- 802.11p physical layer needs to improve (MIMO ?)
- There are very few works dealing with appropriate digital communication strategies for V2V

THANK YOU !

QUESTIONS ?

[1]