



HAL
open science

Global technique analysis for reconfigurable reflectarray antennas

Clement Yann, Renaud Loison, Raphaël Gillard, Michèle Labeyrie, Jean-Paul Martinaud

► **To cite this version:**

Clement Yann, Renaud Loison, Raphaël Gillard, Michèle Labeyrie, Jean-Paul Martinaud. Global technique analysis for reconfigurable reflectarray antennas. European Conference on Antennas and Propagation, Apr 2011, Rome, Italy. pp.147-151. hal-00657321

HAL Id: hal-00657321

<https://hal.science/hal-00657321>

Submitted on 6 Jan 2012

HAL is a multi-disciplinary open access archive for the deposit and dissemination of scientific research documents, whether they are published or not. The documents may come from teaching and research institutions in France or abroad, or from public or private research centers.

L'archive ouverte pluridisciplinaire **HAL**, est destinée au dépôt et à la diffusion de documents scientifiques de niveau recherche, publiés ou non, émanant des établissements d'enseignement et de recherche français ou étrangers, des laboratoires publics ou privés.

Global technique analysis for reconfigurable reflectarray antennas

C. Yann^{*}, R. Loison⁺, R. Gillard[#], M. Labeyrie, J-P Martinaud

^{**#} *European University of Brittany, France, INSA, IETR, UMR 6164, F-35708 Rennes,*

^{*}*Clement.Yann@insa-rennes.fr*

⁺*Renaud.Loison@insa-rennes.fr*

[#]*Raphael.Gillard@insa-rennes.fr*

Abstract— This paper focuses on the simulation of reconfigurable reflectarrays. A new method combining the 'surrounded-cell' approach and the compression method is presented. The method considers the real environment of the radiated elements and it only requires one lightweight electromagnetic simulation for the whole reflectarray.

I. INTRODUCTION

In recent years, reflectarray technology [1] is of growing interest in the field of telecommunications as it combines attractive features of reflector and array antennas. Reflectarrays have numerous advantages such as their ease of fabrication, low-profile, high-gain, lightweight, and electrically steerable capability. A microstrip reflectarray antenna consists of a reflecting surface fed by a horn antenna (Fig. 1).

This paper focuses on the simulation of reconfigurable reflectarrays. The concept of reconfigurable reflectarray is based on dynamic phase control of the scattered wave. Every cell is loaded with commutation elements such as diodes or MEMS [2]. The radiating elements have a similar physical structure and they differ only by active element states. This type of cell is able to adaptively change the phase of the radiated wave by electronically switching the active elements state. When all the active elements are switched in optimal positions, it defines a configuration of the reflectarray. Consequently, by changing the configuration dynamically, the far-field pattern can be controlled.

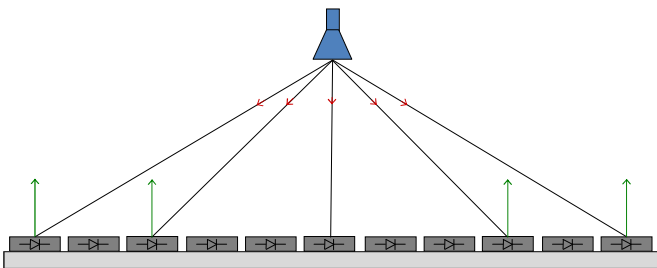

Fig. 1 reconfigurable reflectarray antenna in 2D

Reflectarray analysis is a major issue and due to the problem size, segmented methods have been developed.

In the case of passive reflectarrays, two commonly used methods are the Floquet approach [3], and the 'surrounded-cell' method [4]. The first one assumes that the unitary cell is extracted from an infinite periodic array of identical cells. However, it approximates mutual coupling given the fact that, in reality, the cells within the reflectarray are different. The 'surrounded cell' approach has been developed to take into account mutual coupling. This method is based on the analysis of the studied cell together with its neighbours.

For reconfigurable reflectarrays, the Floquet approach can be combined to the compression approach [5], [6] to simulate each unit-cell loaded by active elements. A unit cell extracted from an infinite array is electromagnetically simulated and a circuit simulation is realized to derive the cell response for all possible cell configurations [7].

In this paper, a new method combining the 'surrounded-cell' approach and the compression method is presented.

II. PRINCIPLE

In order to compute the reflectarray radiation pattern, the proposed method consists in summing up the field radiated by each cell taking into account its actual environment. The radiation pattern of each surrounded element is computed through the simulation of sub-arrays composed of the considered cell and its neighbours. In order to compute the radiation pattern of the considered cell, the whole sub-array is illuminated and the field radiated by the considered cell is determined. The fact that cells only differ by active element states permits to determine all surrounded radiation patterns thanks to only one electromagnetic analysis and light post-processing computations.

Each cell of the reflecting array surface is studied one after the other along with its neighbours (Fig. 2). For convenience, the unit cell is a dipole and only one active element, which is a diode, per cell is considered. Moreover, a sub-array of nine cells is considered but the method is expandable to a larger sub-array. The excitation surface includes the whole sub-array while the Huygens surface only surrounds the studied cell. This surface permits to determine the resulting far-field from the studied cell when all the cells of the sub-array are excited.

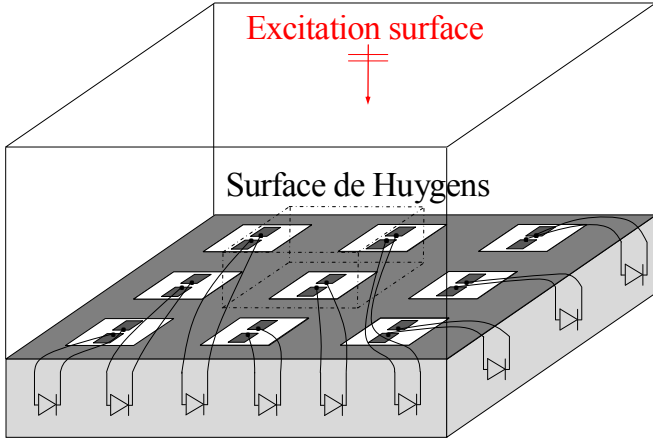

Fig.2 sub-array composed of 9 cells

Active elements, such as diodes in this example, have negligible size compared to wavelength so they can be considered as localized elements. The structure is decomposed into two parts. The first part includes localized elements and the second one, the distributed passive part, includes the sub-array in which localized elements are replaced by ports (Fig. 3). The electromagnetic simulation of the distributed passive part is first carried out.

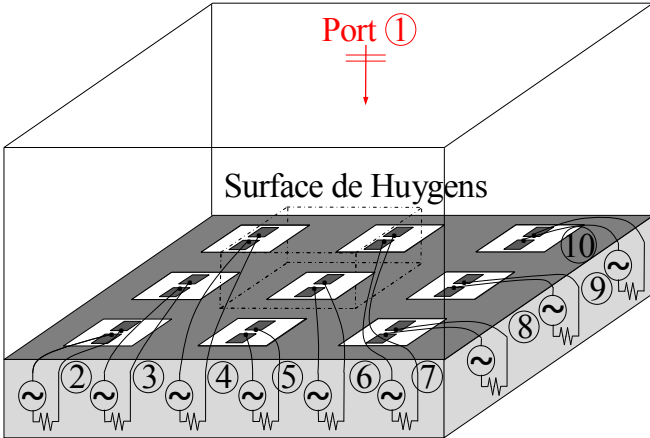

Fig. 3 electromagnetic simulation of the 3x3 sub-array

Next, each of the 9 localized ports plus the plane wave excitation port is excited independently. When one port is excited, the others are terminated with 50-Ohm impedance. When port k is excited, an incident wave a_k is injected and the normalized far-field $\vec{\mathcal{E}}_k^r = \frac{\vec{E}_k^r}{a_k}$ radiated from the central cell is recorded. Reflection and transmission parameters between ports are gathered in a generalized scattering matrix $[S]$.

Then, the compression method is applied in order to take into account on- and off-state equivalent impedances of diodes. A circuit simulation is realized (Fig. 4), that is to say a wave a_1 is sent on port 1 and the simulator computes the other coefficients a_k and b_k . The coefficient a_1 associated to the

incident plane wave on port 1 depends on the desired amplitude and is equal to $a_1 = \sqrt{\frac{\|\vec{E}_1^{\text{inc}}\|^2}{\eta_0}} S$ with S the excitation

surface, \vec{E}_1^{inc} the incident E-field on port 1 and η_0 the vacuum impedance. The compute coefficients a_i $2 \leq i \leq 10$ corresponds to the combinations between the radiation patterns of the loaded structure previously exported.

Finally, the cell response is obtained by summing the contribution of each port. The E-field radiated by the cell is : $\vec{E}_{\text{cellule}}^r = \sum_{k=1}^{10} a_k \vec{\mathcal{E}}_k^r$.

Note that the method is described for one polarization and one incidence angle of the incident field. The generalization is achieved simply by adding an excitation port for each polarization and incidence.

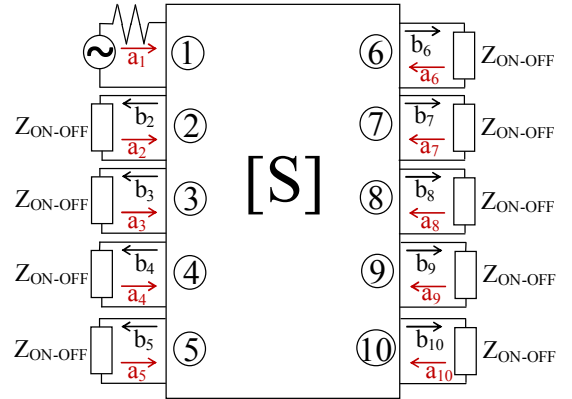

Fig. 4 generalized S-matrix

The same procedure is repeated for all cells using the same electromagnetic simulation and individual responses are computed. In agreement with the superposition principle, the radiation pattern of the global antenna is the sum of all the unit-cell contributions.

III. METHOD ADVANTAGES

The major advantage of this method is that it allows actual mutual coupling effects to be accounted for. Unlike Floquet method, it considers the real environment of the radiated elements.

Moreover, it requires only one lightweight electromagnetic simulation for the whole reconfigurable reflectarray antenna which is time-saving.

Furthermore, the radiation pattern of any configuration of the reflectarray is determined promptly by circuit simulation. The method is independent of the number of cells in the array and it is expandable to analyze electrically large structures.

Lastly, any numerical simulation method, as for example MoM, FEM or FDTD, can be used for the electromagnetic simulation.

IV. RESULTS

A reconfigurable reflectarray composed of 64 cells is simulated using the electromagnetic HFSS® commercial software and with different approaches at 8.7GHz.

The unit cell consists of a printed circuit with 4 diodes inside a rectangular waveguide [8] as shown on Fig. 5. The two pairs of diodes, located on the printed circuit, exhibit 4 phase values. Diodes have a forward "On" resistance of fractions of Ohms (Z_{On}) while their reverse blocking capacitance "Off" (Z_{Off}) is in the femtofarad range.

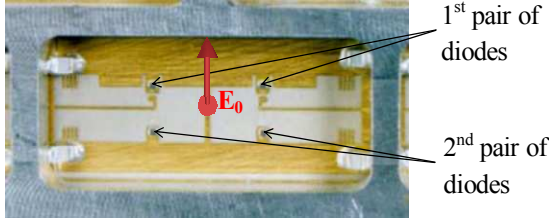

Fig. 5 reflectarray phase shifting cell

360° phase shift is achieved with about 90° progressive steps between each state (Table I). By turning on or off the diodes, it permits to electronically vary the electromagnetic wave path and thus obtain the desired phase response.

TABLE I
PHASE VALUES OF THE CELL WITH FLOQUET APPROACH AT NORMAL INCIDENCE

State	Phase
On-On	0°
Off-Off	-93.1°
On-Off	-176.5°
Off-On	-224.6°

The cells are geometrically identical but the diodes are switched in different positions to control the far-field characteristics.

In this example, a small-sized array of 64 cells (Fig. 6) is studied so that the whole array can be simulated at one time with HFSS®, replacing diodes by their equivalent impedances, Z_{On} or Z_{Off} . This reference simulation allows to compare results from different approaches and to validate the proposed method. The array is illuminated by a normal-incident plane wave and the incident electric field is orthogonal to the slot.

As an example, the desired radiation pattern has a null in the $\theta = 0^\circ$ direction and a main beam on each side of this null

of radiation. To get these characteristics of the radiation pattern, the state of all diodes has to be fixed. The array is divided into two equal parts and the diodes are switched in such a way that there is 180° out of phase from each other. Then, destructive interference occurs, resulting in a null of amplitude at $\theta = 0^\circ$. As shown on Table I, approximately 180° out of phase is obtained between the On-On and the On-Off states of the cell. As a result, diodes on half part of the reflectarray are turned on while the other cells are in On-Off position (Fig. 6).

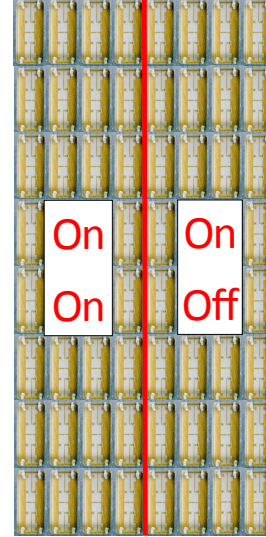

Fig. 6 8x8 reflectarray

The reconfigurable reflectarray is simulated with different approaches :

- global simulation of the reflectarray replacing the diodes with their equivalent impedances,
- Floquet approach combined with the compression technique,
- proposed approach : surrounded cell method combined with the compression technique with 3x3 and 5x5 sub-arrays.

The radiation patterns of the reflectarray with the different methods are overlaid on Fig. 7. The green trace shows the reference and corresponds to the global simulation. The proposed method with 5x5 sub-arrays is represented in red and the blue pattern is obtained with the same approach using 3x3 sub-arrays.

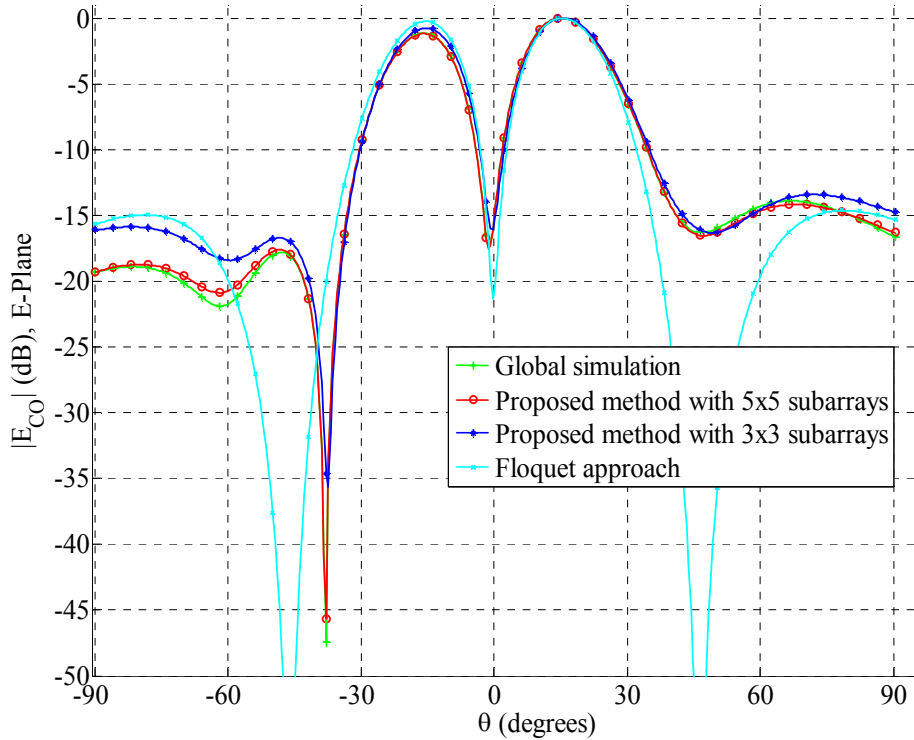

Fig. 7 comparison of the proposed method with 3x3, 5x5 sub-arrays and the Floquet approach for a 8x8 reflectarray

First of all, the proposed approach gives better results than the Floquet approach, in cyan on Fig. 7. Secondly, the reconstruction from sub-arrays composed of 5x5 cells is more accurate than the method with 3x3 sub-arrays. As a consequence, the more neighbours are included in the simulation, the better the prediction is.

The statistical results set out in Table II compare the different approaches to the global simulation, which is the reference for this study. The $\epsilon_{\text{central}}$ parameter estimates the amplitude difference between the studied approach and the reference in the $\theta = 0^\circ$ direction. This central error is 6.5dB for Floquet and less than 1dB for the proposed method. The specified parameter σ is the standard deviation of the amplitude difference between the method under consideration and the reference for θ over the interval $[-90, 90]$ degrees. With the proposed technique using 5x5 subarrays, σ is equal to 1.4dB which is low compared to the 10dB obtained with the Floquet method. The MAE parameter, which stands for “Mean Absolute Error”, is an average of the absolute differences between the method and the reference over the same interval as the previous parameter. A distinct improvement is observed with the proposed method.

Moreover, for each parameter, the proposed method with 5x5 sub-arrays is more accurate than the same method using 3x3 sub-arrays. Thus, the more cells are included in the sub-arrays, the more accurate the results are.

TABLE II
STATISTICAL RESULTS

	Floquet	Proposed method with 3x3 sub-arrays	Proposed method with 5x5 sub-arrays
$\epsilon_{\text{central}}$ (dB)	6.5	0.73	0.08
σ (dB)	10	1.5	0.31
MAE(dB)	5.8	1.2	0.21

In addition, with 49 Go RAM and an Intel[®] Xeon[®] E5506 2.13GHz Quad Core, the simulation of the global antenna requires 407 minutes for each configuration of the reconfigurable reflectarray. In comparison, the new technique analysis requires 72 minutes for the first state and only 38 seconds for any configuration. In this paper, one specific configuration is studied but the method can easily analyze any configuration.

V. CONCLUSIONS

In the present article, a fast and accurate technique to simulate a reconfigurable reflectarray is described and validated. This new method combines the 'surrounded-cell' and the 'compression' approaches and takes into account the actual coupling effects of neighbouring cells. The results show clearly that the proposed method is more accurate than the Floquet approach. Besides, the method requires only one electromagnetic simulation and light post-processing computations. Furthermore, this method is well-adapted for reconfigurable reflectarray no matter what the configuration is and how large the array is.

ACKNOWLEDGMENT

The authors thank Thales Systèmes Aéroportés, Elancourt, France for funding the study.

REFERENCES

- [1] D. Berry, R. Malech and W. Kennedy, "The reflectarray antenna", *IEEE Transactions on Antennas and Propagation*, volume 11, n°6, pp. 645–651, November 1963.
- [2] H. Legay, B. Pinte, M. Charrier, A. Ziaei, E. Girard and R. Gillard, "A steerable reflectarray antenna with MEMS controls", *IEEE International Symposium on Phased Array Systems and Technology*, pp. 494–499, October 2003.
- [3] J. Montgomery, "Scattering by an infinite periodic array of microstrip elements", *IEEE Transactions on Antennas and Propagation*, volume 26, n°6, pp. 850–854, November 1978.
- [4] M.-A. Milon, D. Cadoret, R. Gillard and H. Legay, "Surrounded-element approach for the simulation of reflectarray radiating cells", *IET Microwaves, Antennas & Propagation*, volume 1, n°2, pp. 289–293, April 2007.
- [5] J. Kunisch, M. Rittweger, S. Heinen and I. Wolff, *The compression approach : a new technique for the analysis of distributed circuits containing non linear elements*, 21st EuMC Proceedings, Proceedings of European Conference on Antennas and Propagation, Germany: Stuttgart, September 1991.
- [6] S. Dauguet, R. Gillard, J. Citerne and G. Piton, "Extension of the compression approach to include the treatment of radiation pattern in the electromagnetic analysis of active planar antennas", *Antennas and Propagation Society International Symposium*, volume 1, pp. 22–25, July 1997.
- [7] R. Pereira, R. Gillard, R. Sauleau, P. Potier, T. Dousset and X. Delestre, "Four-state dual polarisation unit-cells for reflectarray applications", *Electronics letters*, volume 46, n°11, May 2010.
- [8] X. Delestre, T. Dousset, M. Labeyrie, C. Renard, "New Challenges for Active ReflectArrays", *International Radar Conference*, Bordeaux, France, 13th October 2009