

**Phosphorylation of HtrA2 by Cyclin Dependant Kinase 5 is important for mitochondrial function.**

Phosphorylation of HtrA2 by Cyclin Dependant Kinase 5

Julia C. Fitzgerald<sup>1</sup>, Marta Delgado Camprubi<sup>1</sup>, Laura Dunn<sup>1</sup>, Hsiu-Chuan Wu<sup>1</sup>, Nancy Y. Ip<sup>4</sup>, Rejko Kruger<sup>2</sup>, L. Miguel Martins<sup>3</sup>, Nicholas W. Wood<sup>1</sup> and H el ene Plun-Favreau<sup>1\*</sup>.

1. Department of Molecular Neuroscience, UCL Institute of Neurology, Queen Square, London, WC1N 3BG, UK.

2. Department of Neurodegeneration, Hertie Institute for Clinical Brain Research and German Research Center for Neurodegenerative Diseases (DZNE), 72076 T ubingen, Germany.

3. Cell Death Regulation Laboratory, MRC Toxicology Unit, Lancaster Road, Leicester, LE1 9HN, UK.

4. Section of Biochemistry and Cell Biology, Division of Life Sciences, Hong Kong University Science and Technology, Hong Kong, China.

\*Correspondence should be addressed to H. PF, Department of Molecular Neuroscience, UCL Institute of Neurology, Queen Square, London, WC1N 3BG. UK, Telephone: 0207 8373611 ext. 4063, e-mail: h.plun-favreau@ion.ucl.ac.uk

**Abstract**

The role of the serine protease HtrA2 in neuroprotection was initially identified by the demonstration of neurodegeneration in mice lacking HtrA2 expression

or function and the interesting finding that mutations adjacent to two putative phosphorylation sites (serines 142 and 400) have been found in Parkinson's disease (PD) patients. However, the mechanism of this neuroprotection and the signalling pathways associated with it remain mostly unknown. Here we report that cyclin dependant kinase 5 (Cdk5), a kinase implicated in the pathogenesis of several neurodegenerative diseases, is responsible for phosphorylating HtrA2 at serine 400 [S400]. HtrA2 and Cdk5 interact in human and mouse cell lines and brain and Cdk5 phosphorylates S400 on HtrA2 in a p38 dependant manner. Phosphorylation of HtrA2 at S400 is involved in maintaining mitochondrial membrane potential under stress conditions and is important for mitochondrial function, conferring cells protection against cellular stress.

### **Keywords**

HtrA2, Cdk5, Phosphorylation, Mitochondria, Parkinson's disease.

### **Introduction**

The serine protease HtrA2 belongs to the high temperature requirement protein family which contain a trypsin-like protease domain and a regulatory C-terminal PDZ domain (1, 2). HtrA2 is imported into mitochondria by a mitochondrial targeting sequence (MTS) and is then inserted into the inner mitochondrial membrane (IMM). A mature form is generated by proteolysis close to the transmembrane domain (TM) and resides within the inner membrane space (3). Upon initiation of apoptosis, mature HtrA2 is released into the cytosol, where it exacerbates apoptosis by binding and neutralising

inhibitor of apoptosis proteins (IAPs). Cytosolic HtrA2 also promotes apoptosis directly via its protease activity (4). Mice lacking HtrA2 protease activity die prematurely and have a parkinsonian, neurodegenerative phenotype (5, 6). Screening of the HtrA2 gene in German Parkinson's disease (PD) patients identified a G399S mutation and an A141S polymorphism (7). An additional R404W mutation was found in a Belgian population (8), but the HtrA2 link to PD has been disputed (9). Functional analyses revealed that the G399S mutation and to a lesser extent A141S results in decreased HtrA2 protease activity, mitochondrial dysfunction, altered mitochondrial morphology and increased susceptibility to cellular stress (7). Notably, these mutations are positioned one amino acid residue downstream of putative kinase phosphorylation sites, S142 and S400 respectively. HtrA2 is phosphorylated close to its TM at S142 upon activation of the p38 signalling pathway and this phosphorylation is dependent on PINK1 (10), a mitochondrial putative kinase associated with PD (11). Phosphorylation at S142 increases HtrA2 protease activity, which in turn increases its protective effect (10). Mimicking phosphorylation at S400, which lies in the PDZ domain of HtrA2, dramatically increases HtrA2 protease activity and might be involved in neuroprotection (10). This prompted us to attempt to identify potential kinases that could phosphorylate HtrA2 at S400.

Cdk5 is a serine/threonine kinase (12) and a member of the highly conserved family of cyclin dependant kinases (13). Cdk5 is unique amongst its family; firstly, it is not activated by cyclins but is regulated exclusively by the brain-specific activator p35, its isoform p39 and their respective truncated forms

p25/p29 (14-16). Secondly, Cdk5 does not regulate cell cycle, rather it has a multi-functional role with diverse reported substrates (17-24). Moreover, mice lacking Cdk5 die prematurely and show disruption of neuronal layering (17). Abnormal Cdk5 activity is associated with several neurodegenerative diseases. In particular, Cdk5 accumulates in neurons with early stage neurofibrillary tangles, in Lewy bodies and in inclusions, principal hallmarks of Alzheimer's disease (AD) (25), PD and amyotrophic lateral sclerosis (ALS) patients respectively (26, 27). Deregulation of Cdk5 is proposed to be a result of the conversion of p35 to p25; since p25 is less readily turned over than p35, this causes aberrant activation of Cdk5 (28). Neurotoxicity causes cleavage of p35 to p25 by calpain (29) and Cdk5-p25 has been confirmed as a key factor in tau aggregation and tangle formation, two hallmarks of AD (30). Strict control of Cdk5 activity in vital neuronal processes such as mitochondrial function (23, 24) may explain why deregulation is associated with neurodegenerative diseases, where dysfunctional mitochondria is implicated (31, 32).

We report that Cdk5 is the kinase responsible for the phosphorylation of HtrA2 at S400 upon activation of the p38 signalling pathway. The interaction between HtrA2 and Cdk5 can occur both in the cytosol and in mitochondria and Cdk5 translocates to mitochondria under stress conditions. Our data suggests that phosphorylation of HtrA2 S400 is important for maintaining mitochondrial membrane potential.

## **RESULTS**

**HtrA2 interacts with Cdk5.** We initially screened for a range of kinases that would phosphorylate recombinant HtrA2 *in vitro* and identified Cdk5 as one of the candidate kinases responsible for HtrA2 phosphorylation (Supplementary Figure S1A). In two human cell lines, the Hek293T embryonic kidney cells and the SH-SY5Y neuroblastoma cells, endogenous Cdk5 is detected in HtrA2 complexes after immunoprecipitation (IP) using a HtrA2 specific antibody, but not an immunoglobulin G (IgG) control antibody (Figure 1A and 1B). These data demonstrate that Cdk5 and HtrA2 interact in both neuronal and non-neuronal human cell lines under normal physiological conditions. The interaction was then validated in human brain tissue. We used exon array data generated in our laboratory to check that Cdk5 mRNA was expressed in human occipital cortex (Supplementary Figure S2A) before we prepared lysates from tissue. We found that Cdk5 and HtrA2 are present in occipital cortex lysates at the protein level and that they interact (Figure 1C). Finally, we investigated whether Cdk5 and HtrA2 interact in cortex and midbrain from wild type [WT] mice and mice overexpressing the Cdk5 activator p25. Cdk5 and HtrA2 interact in the cortex of both WT and p25 transgenic mice (Figure 1D). Protein levels of Cdk5 are increased in midbrains of the p25 transgenic mice compared to WT animals (Figure 1E). As a result, the interaction is greatly increased in the midbrains of the p25 transgenic mice (Figure 1E). The extents to which Cdk5 and HtrA2 interact under normal physiological conditions vary between cortex and midbrain in these mice (Figure 1D and 1E).

**Regulation of Cdk5/HtrA2 interaction.** Targeted siRNA against Cdk5 in Hek293T cells knocks down Cdk5 expression by approximately 80% at the protein level compared to scramble sequence siRNA control (Supplementary Figure S2B). As a result, co-IP from Cdk5 knockdown [KD] cells was undetectable (Figure 2A). The Cdk5 inhibitor Roscovitine also significantly reduced the interaction between Cdk5 and HtrA2 detected by co-IP in SH-SY5Y cells (Figure 2B) and Hek293T cells (Figure 2C). These experiments suggest that the active Cdk5 enzyme preferentially interacts with HtrA2. Consistently, HtrA2 and Cdk5 interact in WT Mouse Embryonic Fibroblasts (MEFs) but not in HtrA2 KO MEFs (Figure 2D). Cdk5 has previously been shown to be activated by a number of stimuli *in vitro* including epidermal growth factor (EGF), calcium ionophore and glutamate (33). Accordingly, glutamate increased the interaction between HtrA2 and Cdk5 detected by co-IP in Hek293T cells (Supplementary Figure S2C). Furthermore, we tested whether the interaction between Cdk5 and HtrA2 could be enhanced upon stimulation of the c-jun N terminal kinase (JNK), p38 stress-activated mitogen-activated protein kinase (MAPK), ERK MAPK and Akt pathways. For this, we used 4-hydroxytamoxifen (4OH-Tx) inducible-stable versions of MEKK1, MEKK3, Akt and Raf (Hek293:  $\Delta$ MEKK1-ER,  $\Delta$ MEKK3-ER and NIH3T3: myrAkt-ER and  $\Delta$ Raf-DD-ER stable cell lines) (10, 34). These experiments showed that only activation of the p38 signalling pathway induced significant phosphorylation of HtrA2 (S400) (Supplementary Figure S1B). The interaction between Cdk5 and HtrA2 is increased upon stimulation of the p38 signalling pathway compared to control conditions (Figure 2E). These data indicate that

the interaction of HtrA2 and Cdk5 is enhanced following activation of stress signalling pathways.

**Cdk5 Phosphorylates HtrA2 at serine 400.** S400 of HtrA2 forms part of a motif (S/T)PX(K/H/R) identified by Scansite ([www.scansite.mit.edu/](http://www.scansite.mit.edu/)) to be a consensus sequence for Cdk5 phosphorylation (underlined in Figure 3A). *In vitro*, Cdk5/p25 preferentially and strongly phosphorylates a S400 containing HtrA2 peptide substrate and not a serine 142 [S142] containing HtrA2 peptide, whilst it is unable to phosphorylate the S400 peptide where the S400 is mutated to an alanine (Supplementary Figure S1C). To further investigate the phosphorylation of HtrA2 by Cdk5, we performed *in vitro* kinase assays with Cdk5/p25 and recombinant HtrA2. A generic substrate (myelin basic protein-MBP) and a known substrate of Cdk5 (human recombinant Tau) were used as controls. Cdk5 phosphorylates MBP, Tau, WT HtrA2 and HtrA2 S142A. However, HtrA2 S400A and HtrA2 S142/400A are phosphorylated by approximately 60% less than WT HtrA2 (Supplementary Figure S1D), suggesting that Cdk5 preferentially phosphorylates HtrA2 at S400 *in vitro*. To investigate the phosphorylation of HtrA2 by Cdk5 *in situ*, we raised an antibody that specifically recognised HtrA2 only when phosphorylated on S400. Phospho-S400 HtrA2 signal was detected in  $\Delta$ MEKK3-ER Hek293 cells after activation with 4OH-Tx, strongly suggesting that HtrA2 is phosphorylated at this site following activation of the p38 stress pathway (Figure 3B). KD of Cdk5 using targeted siRNA significantly reduces phosphorylation of HtrA2 at S400 upon 4OH-Tx stimulation in  $\Delta$ MEKK3-ER Hek293 cells, indicating that Cdk5 is important for phosphorylation of HtrA2 at this site upon stimulation of

the p38 stress pathway (Figure 3C). Consistently, inhibition of Cdk5 activity with Roscovitine significantly reduces phosphorylation of HtrA2 at S400 in Hek293T cells (Figure 3D) and phosphorylation of HtrA2 S400 in Cdk5 KO MEF cells is decreased compared to WT controls (Figure 3E). These data indicate that Cdk5 is important for phosphorylation of HtrA2 at the S400 site. This is not to say that Cdk5 is the only kinase responsible for phosphorylating S400 and residual phosphorylation at this site in siRNA or Roscovitine treated cells or in Cdk5 KO MEF cells may be due to phosphorylation by other kinases such as p38, Cdc2 or GSK3 $\beta$ . Indeed, we have observed some phosphorylation of the S400 peptide by p38 and Cdc2 *in vitro* (Supplementary Figure S1C) and a weak interaction between HtrA2 and Cdc2 by co-IP (Data not shown).

Next we overexpressed HtrA2 and the non-phosphorylatable HtrA2 mutants S142A, S400A and S142/400A in HtrA2 KD  $\Delta$ MEKK3-ER cells with or without stimulation of the p38 pathway. We found that WT and S142A HtrA2 were phosphorylated at S400 upon stimulation of the p38 pathway, whereas the S400A HtrA2 mutant was phosphorylated to a much less extent and S142/400A HtrA2 mutant was decreased (Figure 3F). These data confirm the specificity of the Phospho-S400 HtrA2 antibody. Notably the S142/400A double phosphomutant is the least able to be phosphorylated, suggesting that regulation of HtrA2 by Cdk5 requires a functional serine at the 142 position.

The G399S HtrA2 mutation reported in German PD patients is positioned one amino acid downstream of S400 (7, 10). We sought to investigate whether this mutation can affect the phosphorylation of HtrA2 at S400 by Cdk5. We



therefore, assessed HtrA2 phosphorylation at S400 in cortex from transgenic mice expressing the G399S HtrA2 mutation. Interestingly, these brains contain less phospho-HtrA2 S400 compared with WT mice brains whenever the levels of HtrA2 are equivalent (Figure 3G). This indicates that the G399S HtrA2 mutation reduces its ability to be phosphorylated at the adjacent S400. In addition, we tested the ability of overexpressed G399S HtrA2 to interact with endogenous Cdk5 in Hek293T cells. We found that G399S HtrA2 interacts with endogenous Cdk5 in a similar manner to overexpressed WT HtrA2 (Supplementary Figure S2E), suggesting that the decreased phosphorylation of G399S HtrA2 at S400 is not due to its inability to interact with Cdk5.

**Cdk5 and HtrA2 interact in cytosol and mitochondria.** Cdk5 is commonly thought to be distributed throughout the cytoplasm of mammalian cells (13). Cdk5 has also been reported to localise to the nucleus and mitochondria in the central nervous system of WT mice and rats respectively (35, 36). To determine the localisation of Cdk5 in Hek293T and SH-SY5Y cells, cytosolic and mitochondrial subcellular fractionation was performed. Cdk5 was found in both cytoplasm and inner mitochondrial membrane (IMM) fractions (Figure 4A). The purity of each fraction was assessed by probing for cytosolic and mitochondrial markers (Figure 4A, lower panels). To confirm these observations Cdk5 was immunostained in SH-SY5Y cells expressing the dsREDmito plasmid, which labels mitochondria red. Merging the signal for Cdk5 and mitochondria using high resolution confocal microscopy revealed that Cdk5 is indeed localised both in the cytoplasm and mitochondria (Figure 4B). To investigate whether stress might influence the mitochondrial location

of Cdk5 we used immunostaining of Cdk5 in SH-SY5Y cells expressing the dsREDmito plasmid with glutamate treatment. Co-localisation of Cdk5 and mitochondria was determined using high resolution confocal microscopy, where 3D images were quantified using Pearson's correlation (Zeiss co-localisation software). Interestingly, glutamate treatment significantly increases the mitochondrial pool of Cdk5. This is also the case for Cdk5 activators p35/p25 (Figure 4C). This suggests that Cdk5 and its activators translocate to mitochondria under stress conditions and that Cdk5 location may be an important requirement for interaction with mitochondrial substrates such as HtrA2. Consistently, the interaction between HtrA2 and Cdk5 occurs in both cytosolic and mitochondrial fractions and this interaction is increased with glutamate treatment (Figure 4D). These data show that HtrA2 and Cdk5 interact in mitochondria and in the cytosol. Cdk5 translocation to mitochondria may be important for regulating the protease activity of HtrA2 within mitochondria, which is known to be important for maintaining mitochondrial quality control, respiration status and preventing increased oxidative stress/cell death (37).

**HtrA2 Phosphorylation at serine 400 by Cdk5 is important for mitochondrial function.** The neuroprotective function of HtrA2 has been attributed to its mitochondrial role but little is understood about the exact mechanism. We therefore investigated the relevance of HtrA2 phosphorylation at S400 to mitochondrial membrane potential ( $\Delta\psi_m$ ), a marker of mitochondrial health, using TMRM, a cationic, mitochondrial selective probe with live cell microscopy. We overexpressed HtrA2 and non-phosphorylatable

HtrA2 carrying S to A mutations in an HtrA2 KD. We then measured  $\Delta\psi_m$  in these cells under normal conditions and following activation of the p38 signalling pathway. HtrA2 KD was confirmed by Western blot (Supplementary Figure S2B). Silencing HtrA2 results in a significantly lower (~50%)  $\Delta\psi_m$  in cells where the p38 pathway is activated (Figure 5A), whereas HtrA2 silencing in non-stressed cells does not have any significant effect on  $\Delta\psi_m$ . Loss of  $\Delta\psi_m$  in HtrA2 silenced cells where the p38 pathway is activated is restored by overexpression of WT and S142A HtrA2 but not by S400A or S142/400A HtrA2 overexpression (Figure 5A). Furthermore, we measured  $\Delta\psi_m$  in Hek293T cells in the presence of the Cdk5 inhibitor Roscovitine. We found a subtle, but consistently lower  $\Delta\psi_m$  in cells where Cdk5 activity was inhibited (15% reduction; Figure 5B). These data suggest that Cdk5 when activated under stress conditions is likely to phosphorylate HtrA2 at S400 in order to maintain mitochondrial health. We have previously reported that mutations mimicking phosphorylation of HtrA2 at S400 are important for regulating the protease activity of this enzyme (10). According to our current data, phosphorylation of S400 of HtrA2 appears to be instrumental to mitochondrial health and phosphorylation within the PDZ domain of HtrA2 at S400 by Cdk5 may be an important mechanism to modulate HtrA2 activity under stress conditions.

## **DISCUSSION**

We have previously shown that phosphomimetic mutants of HtrA2 at S400 result in increased proteolytic activity and contribute to enhanced resistance to mitochondrial stress (10). Here we show that one of the kinases responsible

for phosphorylation of HtrA2 at S400 is Cdk5. The interaction between HtrA2 and Cdk5 occurs in both mitochondria and cytosol. Activation of Cdk5 activity increases its interaction with HtrA2, the phosphorylation of HtrA2 at S400 and translocation of Cdk5 to mitochondria.  $\Delta\psi_m$  is compromised in cells where the p38 pathway is activated and HtrA2 is silenced. Overexpression of WT HtrA2 but not non-phosphorylatable S400A HtrA2 mutant rescues this phenotype, suggesting that phosphorylation of HtrA2 at S400 by Cdk5 is important for mitochondrial health.

HtrA2 is phosphorylated at S400 upon stimulation of the p38 stress signalling pathway. We have previously shown that activation of this pathway induced phosphorylation of HtrA2 at another site, S142, also adjacent to an amino acid found mutated in patients with PD (10). Taken together, these findings suggest that HtrA2 phosphorylation at both of these sites is important for the cellular stress response. HtrA2 is also known to be phosphorylated at S212 by Akt, which reduces its serine protease activity and pro-apoptotic function, thereby promoting cell survival (38). By phosphorylating S400, Cdk5 could also regulate the pro-apoptotic function of HtrA2 once it is released into the cytosol from the mitochondria. Phosphorylation at S400 was previously shown to increase HtrA2 serine protease activity *in vitro* (10). HtrA2 promotes cell death by its ability to bind IAPs but also through its serine protease activity (1, 4) and might therefore, also modulate its pro-apoptotic function, especially since the interaction between Cdk5 and HtrA2 is partly detected in cytosolic fractions.

In mitochondria, HtrA2 is thought to function in a similar manner to that of its bacterial homologues DegS and DegP, which are involved in protection against cell stress (6). Loss of HtrA2 results in accumulation of unfolded proteins in mitochondria, defective mitochondrial respiration and increased oxidative stress (37). Increase in HtrA2 protease activity by Cdk5 phosphorylation, might be important in removing unfolded/damaged proteins in mitochondria. Indeed, both HtrA2 and Cdk5 have recently been linked to autophagy and mitochondrial fission (39, 40, 41), two processes that can be initiated by damage to mitochondrial proteins and which are critical for mitochondrial health. Whether HtrA2 phosphorylation at S400 occurs in the cytosol and/or in the mitochondria, remains to be determined. However, we demonstrate that Cdk5 partially localises with mitochondria in the human SH-SY5Y neuroblastoma cells and that the mitochondrial pool of Cdk5 and its activators p35/p25 is increased following glutamate treatment, suggesting that Cdk5 is available at the mitochondria for phosphorylating HtrA2 under stress conditions where increased protease activity is required.

Certain kinases play an increasingly recognised role in mitochondrial processes (32) and some kinases that are required in mitochondria, including Cdk5, do not contain a mitochondrial targeting sequence (MTS). How they gain entry to the mitochondria remains unclear. It is possible that they could associate with scaffold proteins imported to the mitochondria via a MTS. In the case of Cdk5 it is possible that the distribution of the active protein is dictated by its association with p35. p35 contains an amino terminal myristoylation

signal motif (28), which targets the protein complex to cellular membranes, where many substrates of Cdk5 reside.

Mitochondrial dysfunction is increasingly recognised as playing a crucial role in neurodegenerative diseases; in particular PD. PD-associated proteins PINK1, Parkin and HtrA2 all play important roles at the mitochondria. Contrary to PINK1 and HtrA2, Parkin does not include a MTS (42), yet parkin was recently shown to be recruited by PINK1 to depolarised mitochondria for initiating their clearance from the cell by autophagy (43-46). PINK1, parkin and HtrA2 have been proposed to be components of inter-connected molecular pathways that ultimately lead to mitochondrial dysfunction in PD (47, 11), but the necessity for HtrA2 in these pathways has been disputed, in particular in *Drosophila* (48). Similarly, in humans, whether or not HtrA2 contributes to PD pathogenesis is an area of debate (9). We show here that the PD-associated kinase PINK1, previously shown to bind HtrA2 (10), is not required for the interaction between HtrA2 and Cdk5 (Figure S2D). Though importantly, Cdk5 also phosphorylates the PD-associated protein Parkin and regulates its E3 ubiquitin ligase activity (49), emphasising cellular cross-talk between the pathways associated with neurodegeneration.

Strikingly, we show that HtrA2 phosphorylation at S400 is significantly reduced in brain of mice carrying the G399S HtrA2 mutation, although total levels of HtrA2 protein remain unchanged. This could indicate that HtrA2 phosphorylation (and therefore, increase of its proteolytic activity) is important for mitochondrial function, known to be deregulated in neurodegenerative disorders. We also found that mice overexpressing the Cdk5 activator

associated with neurodegeneration, p25, have increased interaction between Cdk5 and HtrA2 in midbrain, the brain region preferably destroyed in PD. These mice have a well characterised neurodegenerative phenotype with age related deficits in learning and memory (50, 51). Our data suggest that active Cdk5 interacts with HtrA2 and that this is important for HtrA2 protective function in mitochondria. This modulation of HtrA2 may reflect the fine tuning necessary to respond to cellular signals accordingly. Although we suggest that activation of Cdk5 under stress conditions increases the interaction between HtrA2 and Cdk5, this appears to promote mitochondrial health as a stress response. One could hypothesise that the interaction of HtrA2 and Cdk5 could also be proapoptotic, in particular if Cdk5 and HtrA2 interact in the cytosol. Deregulation of Cdk5 is widely reported to promote neurodegeneration; however it is the constitutive activation of Cdk5 rather than activation of Cdk5 that is thought to promote neurodegeneration (28, for a review see 13). Therefore, we propose that transient phosphorylation of HtrA2 by Cdk5 under normal conditions does not contribute to neurodegeneration directly, rather it is a key process responsible for modulating HtrA2 function to fine tune the correct response to the cellular environment.

The exact mechanism of HtrA2 function in mitochondria awaits further characterisation. HtrA2 may be a key player in maintaining mitochondrial protein quality control via its ability to clear damaged or misfolded proteins. We have shown that loss of  $\Delta\psi_m$  in HtrA2 silenced cells under stress induced by the activation of the p38 pathway was rescued by expressing WT and S142A HtrA2 but not the non-phosphorylatable S400A or S142/400A HtrA2

mutants. These data suggest that HtrA2 phosphorylation at S400, and likely subsequent increase of its protease activity, may be important for HtrA2 mitochondrial function. Indeed, previous work indicated that phosphorylation of HtrA2 S400 conferred protection from cell death (10). Since mitochondria do not have an ubiquitin proteasome system, clearance of damaged mitochondrial proteins or regulation of the levels of proteins involved in mitochondrial dynamics is an essential process which in mitochondrial compartments is thought to be heavily reliant upon mitochondrial proteases such as HtrA2. Indeed, modulation of the levels of the intramitochondrial fusion protein OPA1 by HtrA2 protease activity has been shown recently (52). Mitochondrial function is of critical importance in neurons and mitochondrial dysfunction is well documented to be a major factor underlying the pathogenesis of neurodegenerative diseases (53). We have defined a mitochondrial stress response pathway involving Cdk5 and HtrA2, two proteins associated with neurodegeneration. These events may be relevant for neurodegenerative diseases and further characterisation of the pathway involving HtrA2 and Cdk5 that lead to mitochondrial dysfunction may allow better understanding of disease pathogenesis.

## **METHODS**

**Antibodies.** Anti-HtrA2 rabbit polyclonal and Phospho-Cdk5 rabbit polyclonal (Y15) antibodies were from R&D Systems (Minneapolis, MN). Anti-Cdk5 mouse monoclonal (clone DC17) was from Millipore (Billerica, MA). Anti-P35/P25 rabbit polyclonal antibody was from Santa Cruz Biotechnology (Santa Cruz, CA). Anti-Apotrack™ cocktail (Anti-ATP synthase CV $\alpha$ , Anti-



Pyruvate dehydrogenase E1 $\alpha$ , Anti-Glyceraldehyde 3-phosphate dehydrogenase and Anti-Cytochrome c monoclonal antibodies) was from Mitosciences (Eugene, OR). Anti-cdc2 mouse monoclonal was from Cell Signaling Technology (Beverley, MA). The anti-S400 HtrA2 phospho-specific rabbit polyclonal antibody was generated against peptide [C]-Ahx-KVILG-pS-PAHRAG-amide, on the basis of the sequence surrounding the S400 residue on human HtrA2 by Cambridge Research Biochemicals (Cambridge, UK). Anti-mouse and Anti-rabbit antibodies coupled to horseradish peroxidase and bovine immunoglobulins (IgG) were from Sigma Aldrich (Poole, UK). Anti-mouse and Anti-rabbit antibodies coupled to Alexa fluor 488 and TMRM were from Molecular Probes, Invitrogen, Life Technologies (Carlsbad, CA).

**Plasmids and reagents.** Expression constructs encoding HtrA2 were generated using the polymerase chain reaction (PCR) and subcloning the HtrA2 cDNA into the pcDNA3 vector (Invitrogen, Carlsbad, CA). S306A, S142A, S400A and S142A/S400A HtrA2 mutants were generated by site-directed mutagenesis with the QuickChange kit (Stratagene, La Jolla, CA) and confirmed by DNA sequencing. The Cdk5-HA pCMV vector was a gift from Florian Plattner. The p35-myc and p25-GFP vectors were purchased from Addgene. The pBP3:hbER\* vector encoding human  $\Delta$ MEKK1:ER\* and the  $\Delta$ MEKK3:ER stable cell line was a gift from Simon Cook. The myrAkt:ER and  $\Delta$ Raf-DD:ER stable cell lines were a gift from A. Schulze (CR-UK, London). ER stable cell lines were serum starved 16h before treatment with 100nM 4OH-Tx for 8h. 4OH-Tx was from Sigma Adrich (Poole, UK). The dsRED Mito expression vector was a purchased from Clontech (Mountain View, CA).

Effectene transfection reagent was from Qiagen (Hilden, Germany). Non-targeting scramble siRNA and targeted siRNA (siGenome SMARTpool) against Human Cdk5 and PINK1 and Dharmafect transfection reagent were from Dharmacon, Thermo Fisher Scientific (Waltham, MA). Targeted siRNA directed against a site at the 3' UTR of human HtrA2 was purchased from Sigma Genosys (Dorset, U.K) #Hs01\_00010310. Recombinant ERK1, ERK2, Cdk5, p38 $\alpha$ , p38 $\beta$ , p38 $\gamma$  and p38 $\delta$  were obtained from Millipore (Billerica, MA). Recombinant Cdc2 was from New England Biolabs (Ipswich, MA). Recombinant MBP and Human Tau were from Sigma Aldrich (Poole, UK).

**Cell culture.** Human neuroblastoma (SH-SY5Y) cells were a gift from E. E. Billett (NTU, U.K) and Hek293T cells were purchased from ECCAC. Stable cell lines expressing  $\Delta$ MEKK1-ER (Hek293) and dsRED mito (SH-SY5Y) were cloned in our laboratory under initial antibiotic selection. For experiments, all cells were seeded at a density of approximately  $4 \times 10^4$  cells/cm<sup>2</sup> on plastic culture plates, cover slips or flasks and grown to 75-80 % confluence in Dulbecco's Modified Eagles Medium (DMEM) medium containing 10 % (v/v) foetal bovine serum [FBS] (or 10 % (v/v) foetal calf serum [FCS] for MEFs) and 2 mM L-glutamine at 37°C in a 5% CO<sub>2</sub> humidified atmosphere. Overexpression of HtrA2 was achieved using Effectene transfection reagent from Qiagen (Hilden, Germany) according to the manufacturer's instructions. KD of Cdk5, PINK1, HtrA2 or scramble sequence control KD using siRNA were achieved using Dharmafect 1 transfection reagent from Dharmacon, Thermo Fisher Scientific (Waltham, MA) according to the manufacturer's instructions.

**Protein biochemistry.** Cells were lysed in 10 mM Tris–HCl pH 7.6, 5 mM EDTA, 50 mM NaCl, 30 mM sodium pyrophosphate, 50 mM sodium fluoride, 1 mM sodium orthovanadate and 2% (v/v) CHAPS(3-[(3-cholamidopropyl)dimethylammonio]-2-hydroxy-1-propanesulfonic acid) and the insoluble pellet removed before denaturation by boiling in SDS gel sample buffer and being resolved by SDS–PAGE. For IP, cells were lysed in the same buffer. After insoluble material had been pelleted, the supernatants were divided into two equal parts; one was immunoprecipitated overnight with an antibody raised against HtrA2 (2.5µg) and the other immunoprecipitated overnight with bovine IgG antibody (1µg) as a control. Both HtrA2 and control IgG-complexes were then isolated using Protein A–Sepharose beads (30 µl washed in lysis buffer) and subjected to SDS–PAGE. Mitochondria-enriched and cytosolic fractions used for IP were obtained as described previously (54). Cell fractions including mitochondrial subfractions were obtained as described previously (55). All gels were transferred to Immobilon PVDF membranes (Millipore, Billerica, MA). Membranes to be incubated with Anti-HtrA2 Phospho S400 antibody were autoclaved between glass plates containing a sandwich of paper towels and chromatography paper soaked in PBS-tween. All membranes were subsequently incubated with the indicated primary antibody before being incubated with the appropriate secondary antibody.

**Human and mouse brain tissue.** Human brain tissue was obtained from the Queen Square Brain Bank (London) (where it had been donated with informed consent from the next-of kin) with approval from the National Hospital for

Neurology and Neurosurgery–Institute of Neurology Joint Research Ethics Committee. Four flash-frozen brains with idiopathic PD, and four control brains, were used as age-matched and pH-matched controls. Frozen sections were obtained from occipital cortex and white matter from four unaffected individuals. Tissue was homogenized in 10 mM Tris-HCl pH 7.6, 5 mM EDTA, 50 mM NaCl, 30 mM sodium pyrophosphate, 50 mM sodium fluoride, 1 mM sodium orthovanadate and 2% CHAPS, incubated on ice for 45 min, and centrifuged at 13,000g for 15 min at 4 °C. Flash-frozen whole mouse brains from p25 overexpressing transgenic mice and corresponding age and sex matched WT controls were a kind gift from Florian Plattner. Animal husbandry and experimental procedures were performed in full compliance with the United Kingdom Animal (Scientific Procedures) Act of 1986. Mouse tissue of equal weight was homogenised and prepared for SDS-PAGE and/or IP as described above for human tissue. Tissue supernatant lysates from cortex of mice overexpressing G399S HtrA2 under the control of the murine prion promoter were provided by R.K., as cortex was among the brain regions showing highest expression levels of the transgene (unpublished data).

**In vitro kinase assay.** Recombinant HtrA2 (5 µg) was incubated with 100 ng of the indicated kinase in a buffer containing 20 µCi of [ $\gamma$ -<sup>33</sup>P]ATP, 50 mM Tris-HCl pH 7.6, 10 mM MgCl<sub>2</sub>, 10 µM for 1h at 30 °C in a final volume of 12 µl. The assays with recombinant HtrA2, MBP or Tau as a substrate were resolved on a NuPAGE 4–12% Bis-Tris gel (Invitrogen) and the assays, using a peptide as a substrate, were separated on 16% Tricine gels (Invitrogen). After electrophoresis, proteins were transferred to Immobilon PVDF

membrane and exposed to a phosphoscreen. The incorporated radioactivity was detected by autoradiography.

**Microscopy-Immunocytochemistry-Colocalisation.** SH-SY5Y cells expressing dsRedMito were plated on glass coverslips and were treated or not with 5mM glutamate for 4h. Cells were fixed using methanol 90% (v/v) in PBS for 30 min at -20°C. Fixed cells were then permeabilised using 0.5% (v/v) Triton X-100 in PBS for 5 min at room temperature (RT). The detergent was washed out with three changes of PBS before blocking with 1% (w/v) bovine serum albumin (BSA) in PBS for 30 min at RT. The primary antibody was diluted according to the manufacturer's instructions in 1% (w/v) BSA in PBS and incubated in a humidity chamber for 1-2h at RT. Unbound antibody was washed out with three changes of PBS before incubation with anti-mouse or rabbit secondary antibody conjugated to Alexa fluor-488 for 0.5-1h at RT. Unbound antibody was washed out with three changes of PBS. The fixed cells were stained with 1µM DAPI for 5 min at RT before being washed and mounted on glass slides using Vectashield™ mounting medium. To determine colocalisation between antibody (green) and mitochondria (bright red), confocal images were obtained using a Zeiss 510 uv-vis C.

LSM equipped with a META detection system and a 63× oil immersion objective. The 488 nm Argon laser was used to excite the dye bound to antibody and a 580 laser used to excite the dsREDmito. Laser power was kept to a minimum and confocal images were collected in the Y and Z plane and 3D image was generated. The Co-localisation score was quantified using Zeiss software to analyse the overlap of red and green on each 3D image of a

field of view. At least three fields of view were analysed for each independent experiment and  $n=3$ . Laser power was kept constant throughout each image in each experiment.

**Live Microscopy-Mitochondrial Membrane Potential.** Cells were loaded with TMRM (50nM) in Hank's Buffered Salt Solution with calcium and magnesium ions for 40 min at 37°C in a 5% CO<sub>2</sub> humidified atmosphere. TMRM was excited using the 543 nm laser line and fluorescence measured using a 560 nm long pass filter. Confocal images were obtained using a Zeiss 510 uv-vis CLSM equipped with a META detection system and a 40× oil immersion objective. Illumination intensity was kept to a minimum (at 0.1%–0.2% of laser output) to avoid phototoxicity, and the pinhole was set to give an optical slice of 2 mm. Mean, maximum TMRM fluorescence was determined for approximately 80-100 individual mitochondria in a field of view for each condition, for each independent experiment ( $n=3$ ), from Z stack images using Andor IQ™ (Belfast, UK) analysis software.

**Statistical analyses.** All measurements were performed in triplicate, and data are expressed as means  $\pm$  standard deviation mean or mean % control  $\pm$  % control standard deviation. Statistical significance for multiple comparisons was performed using one way ANOVA followed by LSD correction and statistical significance for comparison of two variables was performed using Students T-test. In all cases,  $p < 0.05$  was considered significant.

### **Acknowledgements**

Dr Mina Ryten (UCL, Institute of Neurology) and MRC Sudden Death Brain

Bank, Edinburgh for providing control human brain tissue for co-IP experiments. Dr Florian Plattner (UCL, Institute of Neurology) for providing p25 overexpressing mouse brains and WT age matched controls. Dr Emma Deas (UCL, Institute of Neurology) for providing the SH-SY5Y cells stably expressing dsRED mito. This work was supported by a career development award from the MRC (G0700183). This work was also supported in part by the Wellcome Trust/MRC Joint Call in Neurodegeneration award (WT089698) to the UK Parkinson's Disease Consortium (UKPDC) whose members are from the UCL/Institute of Neurology, the University of Sheffield and the MRC Protein Phosphorylation Unit at the University of Dundee. Generation and characterization of HtrA2 transgenic mice was supported by grants from the Faculty of Medicine, University of Tübingen (Fortuene 1517-0-0) and the German Research Council (DFG, KR2119/3-2) to R.K.

### **Conflict of Interest**

The authors declare no conflict of interest.

### **Supplementary Information**

Supplementary information is available at Cell Death and Differentiation's website

### **References**

1. Li W, Srinivasula SM, Chai J, Li P, Wu JW, Zhang Z, et al. Structural insights into the pro-apoptotic function of mitochondrial serine protease HtrA2/Omi. *Nat Struct Biol.* 2002 Jun;9(6):436-41.

2. Faccio L, Fusco C, Chen A, Martinotti S, Bonventre JV, Zervos AS. Characterization of a novel human serine protease that has extensive homology to bacterial heat shock endoprotease HtrA and is regulated by kidney ischemia. *J Biol Chem*. 2000 Jan 28;275(4):2581-8.
3. Vande Walle L, Lamkanfi M, Vandenabeele P. The mitochondrial serine protease HtrA2/Omi: an overview. *Cell Death Differ*. 2008;15(3):453-60.
4. Van Loo G, van Gurp M, Depuydt B, Srinivasula SM, Rodriguez I, Alnemri ES, et al. The serine protease Omi/HtrA2 is released from mitochondria during apoptosis. Omi interacts with caspase-inhibitor XIAP and induces enhanced caspase activity. *Cell Death and Differentiation*. 2002 Jan;9(1):20-6.
5. Jones JM, Datta P, Srinivasula SM, Ji W, Gupta S, Zhang Z, et al. Loss of Omi mitochondrial protease activity causes the neuromuscular disorder of mnd2 mutant mice. *Nature*. 2003 Oct 16;425(6959):721-7.
6. Martins LM, Morrison A, Klupsch K, Fedele V, Moiso N, Teismann P, et al. Neuroprotective role of the Reaper-related serine protease HtrA2/Omi revealed by targeted deletion in mice. *Mol Cell Biol*. 2004 Nov;24(22):9848-62.
7. Strauss KM, Martins LM, Plun-Favreau H, Marx FP, Kautzmann S, Berg D, et al. Loss of function mutations in the gene encoding Omi/HtrA2 in Parkinson's disease. *Hum Mol Genet*. 2005 Aug 1;14(15):2099-111.
8. Bogaerts V, Nuytemans K, Reumers J, Pals P, Engelborghs S, Pickut B, et al. Genetic variability in the mitochondrial serine protease HTRA2 contributes to risk for Parkinson disease. *Hum Mutat*. 2008 Jun;29(6):832-40.
9. Simon-Sanchez J, Singleton AB. Sequencing analysis of OMI/HTRA2 shows previously reported pathogenic mutations in neurologically normal controls. *Hum Mol Genet*. 2008 Jul 1;17(13):1988-93.



10. Plun-Favreau H, Klupsch K, Moiso N, Gandhi S, Kjaer S, Frith D, et al. The mitochondrial protease HtrA2 is regulated by Parkinson's disease-associated kinase PINK1. *Nat Cell Biol.* 2007 Nov;9(11):1243-52.
11. Fitzgerald JC, Plun-Favreau H. Emerging pathways in genetic Parkinson's disease: autosomal-recessive genes in Parkinson's disease-a common pathway? *FEBS J.* 2008 Dec;275(23):5758-66.
12. Beaudette KN, Lew J, Wang JH. Substrate specificity characterization of a cdc2-like protein kinase purified from bovine brain. *Journal of Biological Chemistry.* 1993 October 5, 1993;268(28):20825-30.
13. Dhavan R, Tsai LH. A decade of CDK5. *Nat Rev Mol Cell Biol.* 2001 Oct;2(10):749-59.
14. Lew J, Huang QQ, Qi Z, Winkfein RJ, Aebersold R, Hunt T, et al. A brain-specific activator of cyclin-dependent kinase 5. *Nature.* 1994 Sep 29;371(6496):423-6.
15. Tsai LH, Delalle I, Caviness VS, Jr., Chae T, Harlow E. p35 is a neural-specific regulatory subunit of cyclin-dependent kinase 5. *Nature.* 1994 Sep 29;371(6496):419-23.
16. Tang D, Yeung J, Lee KY, Matsushita M, Matsui H, Tomizawa K, et al. An isoform of the neuronal cyclin-dependent kinase 5 (Cdk5) activator. *J Biol Chem.* 1995 Nov 10;270(45):26897-903.
17. Ohshima T, Ward JM, Huh CG, Longenecker G, Veeranna, Pant HC, et al. Targeted disruption of the cyclin-dependent kinase 5 gene results in abnormal corticogenesis, neuronal pathology and perinatal death. *Proceedings of the National Academy of Sciences of the United States of America.* 1996 October 1, 1996;93(20):11173-8.

18. Chae T, Kwon YT, Bronson R, Dikkes P, Li E, Tsai LH. Mice lacking p35, a neuronal specific activator of Cdk5, display cortical lamination defects, seizures, and adult lethality. *Neuron*. 1997 Jan;18(1):29-42.
19. Zukerberg LR, Patrick GN, Nikolic M, Humbert S, Wu CL, Lanier LM, et al. Cables links Cdk5 and c-Abl and facilitates Cdk5 tyrosine phosphorylation, kinase upregulation, and neurite outgrowth. *Neuron*. 2000 Jun;26(3):633-46.
20. Niethammer M, Smith DS, Ayala R, Peng J, Ko J, Lee MS, et al. NUDEL is a novel Cdk5 substrate that associates with LIS1 and cytoplasmic dynein. *Neuron*. 2000 Dec;28(3):697-711.
21. Lazaro JB, Kitzmann M, Poul MA, Vandromme M, Lamb NJ, Fernandez A. Cyclin dependent kinase 5, cdk5, is a positive regulator of myogenesis in mouse C2 cells. *J Cell Sci*. 1997 May;110 ( Pt 10):1251-60.
22. Li BS, Ma W, Jaffe H, Zheng Y, Takahashi S, Zhang L, et al. Cyclin-dependent kinase-5 is involved in neuregulin-dependent activation of phosphatidylinositol 3-kinase and Akt activity mediating neuronal survival. *J Biol Chem*. 2003 Sep 12;278(37):35702-9.
23. Qu D, Rashidian J, Mount MP, Aleyasin H, Parsanejad M, Lira A, et al. Role of Cdk5-mediated phosphorylation of Prx2 in MPTP toxicity and Parkinson's disease. *Neuron*. 2007 Jul 5;55(1):37-52.
24. Sun KH, de Pablo Y, Vincent F, Shah K. Deregulated Cdk5 promotes oxidative stress and mitochondrial dysfunction. *J Neurochem*. 2008 Oct;107(1):265-78.
25. Pei JJ, Grundke-Iqbal I, Iqbal K, Bogdanovic N, Winblad B, Cowburn RF. Accumulation of cyclin-dependent kinase 5 (cdk5) in neurons with early stages

of Alzheimer's disease neurofibrillary degeneration. *Brain Res.* 1998 Jun 29;797(2):267-77.

26. Nakamura S, Kawamoto Y, Nakano S, Akiguchi I, Kimura J. p35(nck5a) and cyclin-dependent kinase 5 colocalize in Lewy bodies of brains with Parkinson's disease. *Acta Neuropathol.* 1997 Aug;94(2):153-7.

27. Nakamura S, Kawamoto Y, Nakano S, Ikemoto A, Akiguchi I, Kimura J. Cyclin-dependent kinase 5 in Lewy body-like inclusions in anterior horn cells of a patient with sporadic amyotrophic lateral sclerosis. *Neurology.* 1997 Jan;48(1):267-70.

28. Patrick GN, Zukerberg L, Nikolic M, de la Monte S, Dikkes P, Tsai LH. Conversion of p35 to p25 deregulates Cdk5 activity and promotes neurodegeneration. *Nature.* 1999 Dec 9;402(6762):615-22.

29. Lee MS, Kwon YT, Li MW, Peng JM, Friedlander RM, Tsai LH. Neurotoxicity induces cleavage of p35 to p25 by calpain. *Nature.* 2000 May 18;405(6784):360-4.

30. Noble W, Olm V, Takata K, Casey E, Mary O, Meyerson J, et al. Cdk5 is a key factor in tau aggregation and tangle formation in vivo. *Neuron.* 2003 May 22;38(4):555-65.

31. Burchell VS, Gandhi S, Deas E, Wood NW, Abramov AY, Plun-Favreau H. Targeting mitochondrial dysfunction in neurodegenerative disease: Part I. *Expert Opin Ther Targets.* 2010 Apr;14(4):369-85.

32. Burchell VS, Gandhi S, Deas E, Wood NW, Abramov AY, Plun-Favreau H. Targeting mitochondrial dysfunction in neurodegenerative disease: Part II. *Expert Opin Ther Targets.* 2010 May;14(5):497-511.

33. Cheung ZH, Fu AKY and Ip NY. Synaptic roles of Cdk5: Implications in higher cognitive functions and neurodegenerative diseases. 2006 April;50:13-18.
34. Garner AP, Weston CR, Todd DE, Balmano K, Cook SJ. Delta MEKK3:ER\* activation induces a p38 alpha/beta 2-dependent cell cycle arrest at the G2 checkpoint. *Oncogene*. 2002 Nov 21;21(53):8089-104.
35. Xie Z, Sanada K, Samuels BA, Shih H, Tsai LH. Serine 732 phosphorylation of FAK by Cdk5 is important for microtubule organization, nuclear movement, and neuronal migration. *Cell*. 2003 Aug 22;114(4):469-82.
36. Sugiyama K, Fujii H. Intracellular Localization of Cyclin-dependent Kinase 5 (CDK5) in Rat Central Nervous System. *Journal of Meikai University School of Dentistry*. 2001;30(1):37-46.
37. Moiso N, Klupsch K, Fedele V, East P, Sharma S, Renton A, et al. Mitochondrial dysfunction triggered by loss of HtrA2 results in the activation of a brain-specific transcriptional stress response. *Cell Death Differ*. 2009 Mar;16(3):449-64.
38. Yang L, Sun M, Sun XM, Cheng GZ, Nicosia SV and Cheng JQ. Akt attenuation of the serine protease activity of HtrA2/Omi through phosphorylation of serine 212. *J Biol Chem*. 2007 Apr;282(15):10981-7.
39. Wong ASL, Lee RHK, Cheung AY, Yeung PK, Chung SK, Cheung ZH and Ip NY. Cdk5-mediated phosphorylation of endophilin B1 is required for induced autophagy in models of Parkinson's disease. *Nature Cell Biology*. 2011 Apr; 13:568-79.

40. Meurer K, Suppanz IE, Lingor P, Planchamp V, Gorické B, Fichtner L, et al. Cyclin-dependent kinase 5 is an upstream regulator of mitochondrial fission during neuronal apoptosis. *Cell Death Differ.* 2007 Apr;14(4):651-61.
41. Li B, Hu Q, Wang H, Man N, Ren H, Wen L, et al. Omi/HtrA2 is a positive regulator of autophagy that facilitates the degradation of mutant proteins involved in neurodegenerative diseases. *Cell Death Differ.* 2010 Nov;17(11):1773-84.
42. Shimura H, Hattori N, Kubo S, Mizuno Y, Asakawa S, Minoshima S, et al. Familial Parkinson disease gene product, parkin, is a ubiquitin-protein ligase. *Nat Genet.* 2000 Jul;25(3):302-5.
43. Deas E, Wood NW, Plun-Favreau H. Mitophagy and Parkinson's disease: The PINK1-parkin link. *Biochim Biophys Acta.* 2010 Aug 21.
44. Narendra D, Tanaka A, Suen DF, Youle RJ. Parkin-induced mitophagy in the pathogenesis of Parkinson disease. *Autophagy.* 2009 Jul 1;5(5):706-8.
45. Matsuda N, Sato S, Shiba K, Okatsu K, Saisho K, Gautier CA, et al. PINK1 stabilized by mitochondrial depolarization recruits Parkin to damaged mitochondria and activates latent Parkin for mitophagy. *J Cell Biol.* 2010 Apr 19;189(2):211-21.
46. Vives-Bauza C, Zhou C, Huang Y, Cui M, de Vries RL, Kim J, et al. PINK1-dependent recruitment of Parkin to mitochondria in mitophagy. *Proc Natl Acad Sci U S A.* 2010 Jan 5;107(1):378-83.
47. Whitworth AJ, Lee JR, Ho VM, Flick R, Chowdhury R, McQuibban GA. Rhomboid-7 and HtrA2/Omi act in a common pathway with the Parkinson's disease factors Pink1 and Parkin. *Dis Model Mech.* 2008 Sep-Oct;1(2-3):168-74;.

48. Yun J, Cao JH, Dodson MW, Clark IE, Kapahi P, Chowdhury RB, et al. Loss-of-function analysis suggests that Omi/HtrA2 is not an essential component of the PINK1/PARKIN pathway in vivo. *J Neurosci*. 2008 Dec 31;28(53):14500-10.
49. Avraham E, Rott R, Liani E, Szargel R and Engelender S. Phosphorylation of Parkin by the Cyclin-dependent Kinase 5 at the Linker Region Modulates its Ubiquitin-Ligase Activity and Aggregation. *J Biol Chem*. 2007 April 27; 282(17): 12842-50.
50. Cruz JC, Tseng HC, Goldman JA, Shih H, Tsai LH. Aberrant Cdk5 activation by p25 triggers pathological events leading to neurodegeneration and neurofibrillary tangles. *Neuron*. 2003 Oct 30;40(3):471-83.
51. Fischer A, Sananbenesi F, Pang PT, Lu B, Tsai LH. Opposing roles of transient and prolonged expression of p25 in synaptic plasticity and hippocampus-dependent memory. *Neuron*. 2005 Dec 8;48(5):825-38.
52. Kieper N, Holmstrom KM, Ciceri D, Fiesel FC, Wolburg H, Ziviani E, et al. Modulation of mitochondrial function and morphology by interaction of Omi/HtrA2 with the mitochondrial fusion factor OPA1. *Exp Cell Res*. 2010 Apr 15;316(7):1213-24.
53. Abou-Sleiman PM, Muqit MM, Wood NW. Expanding insights of mitochondrial dysfunction in Parkinson's disease. *Nat Rev Neurosci*. 2006 Mar;7(3):207-19.54.
54. Samali A, Cai J, Zhivotovsky B, Jones DP, Orrenius S. Presence of a pre-apoptotic complex of pro-caspase-3, Hsp60 and Hsp10 in the mitochondrial fraction of jurkat cells. *EMBO J*. 1999 Apr 15;18(8):2040-8.

55. Stanyer L, Jorgensen W, Hori O, Clark JB, Heales SJ. Inactivation of brain mitochondrial Lon protease by peroxynitrite precedes electron transport chain dysfunction. *Neurochem Int.* 2008 Sep;53(3-4):95-101.

# Figure 1

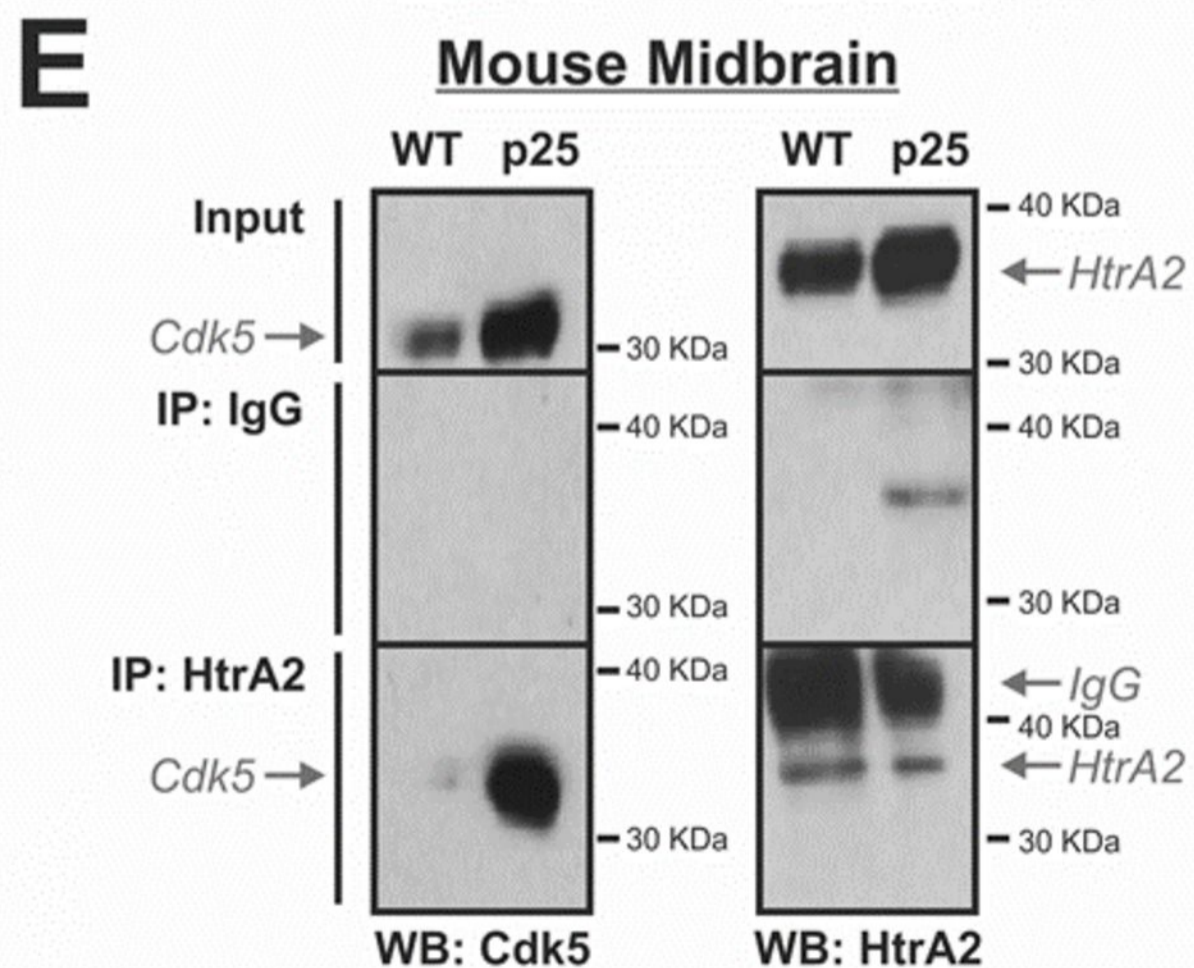
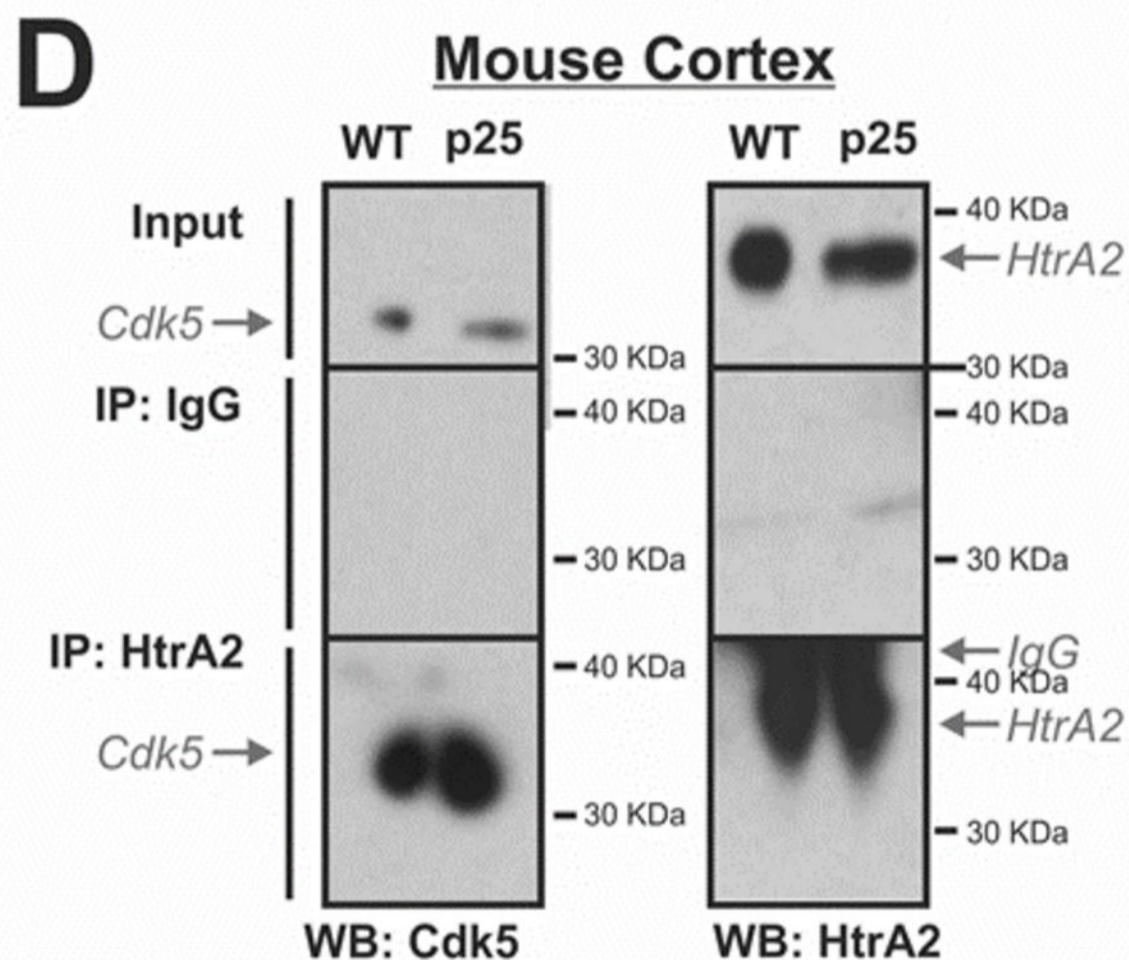
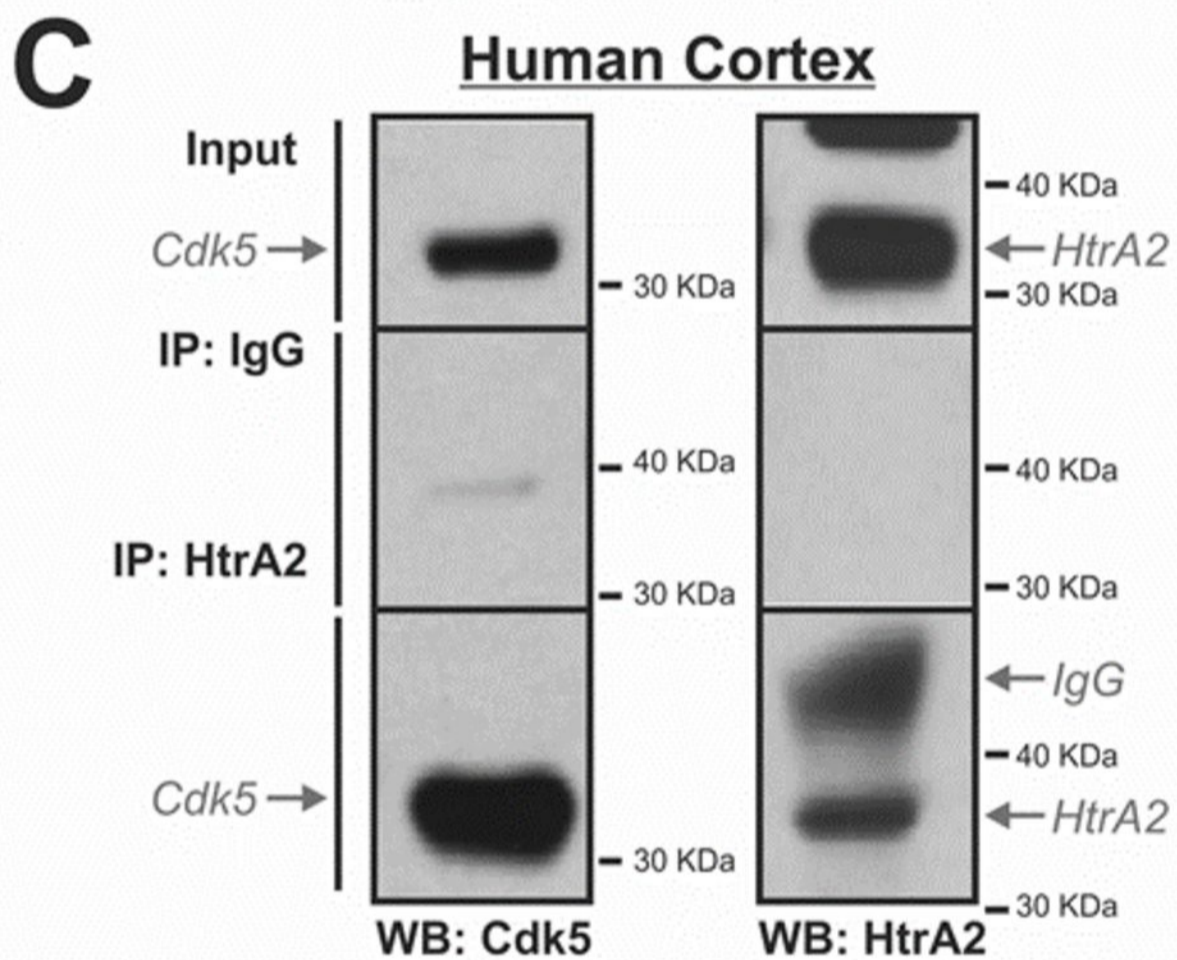
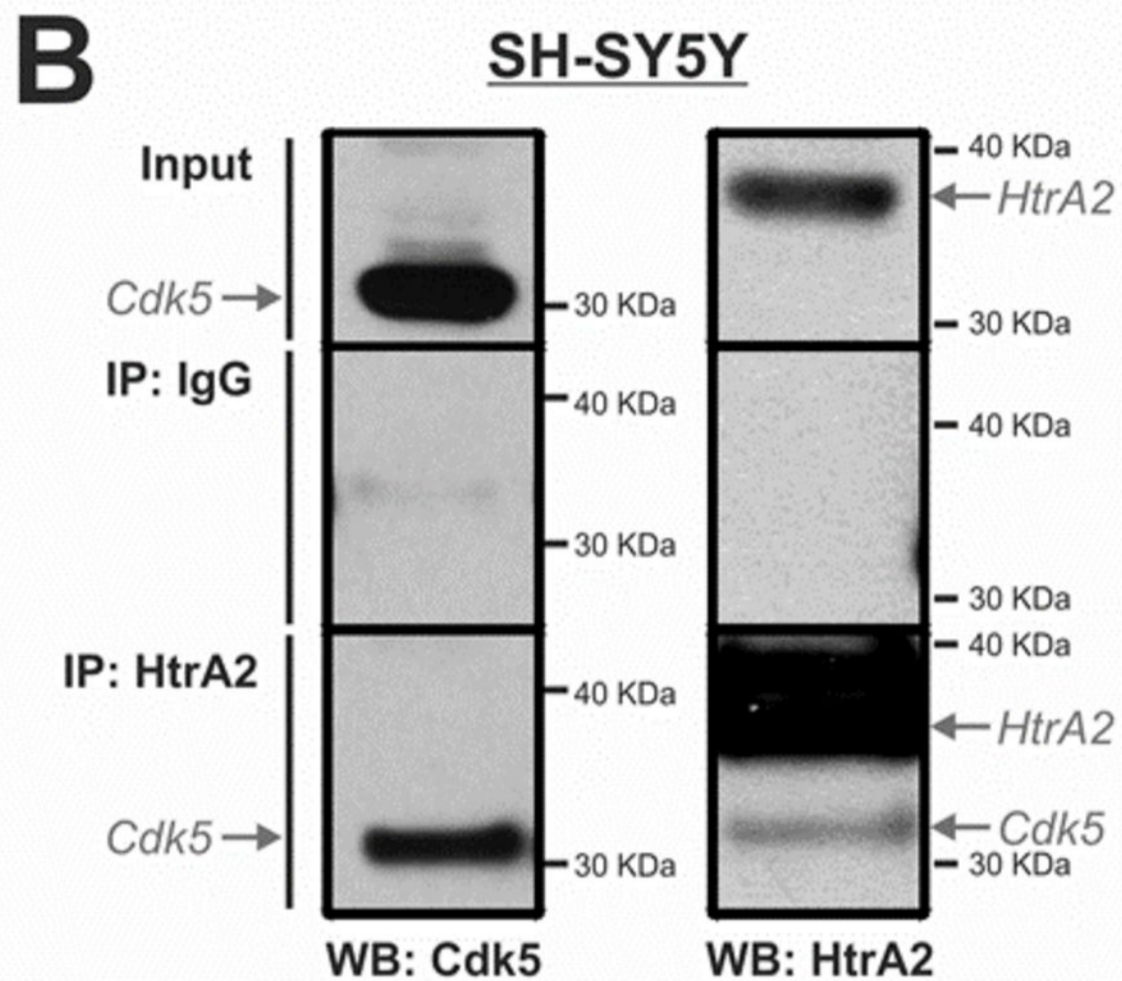
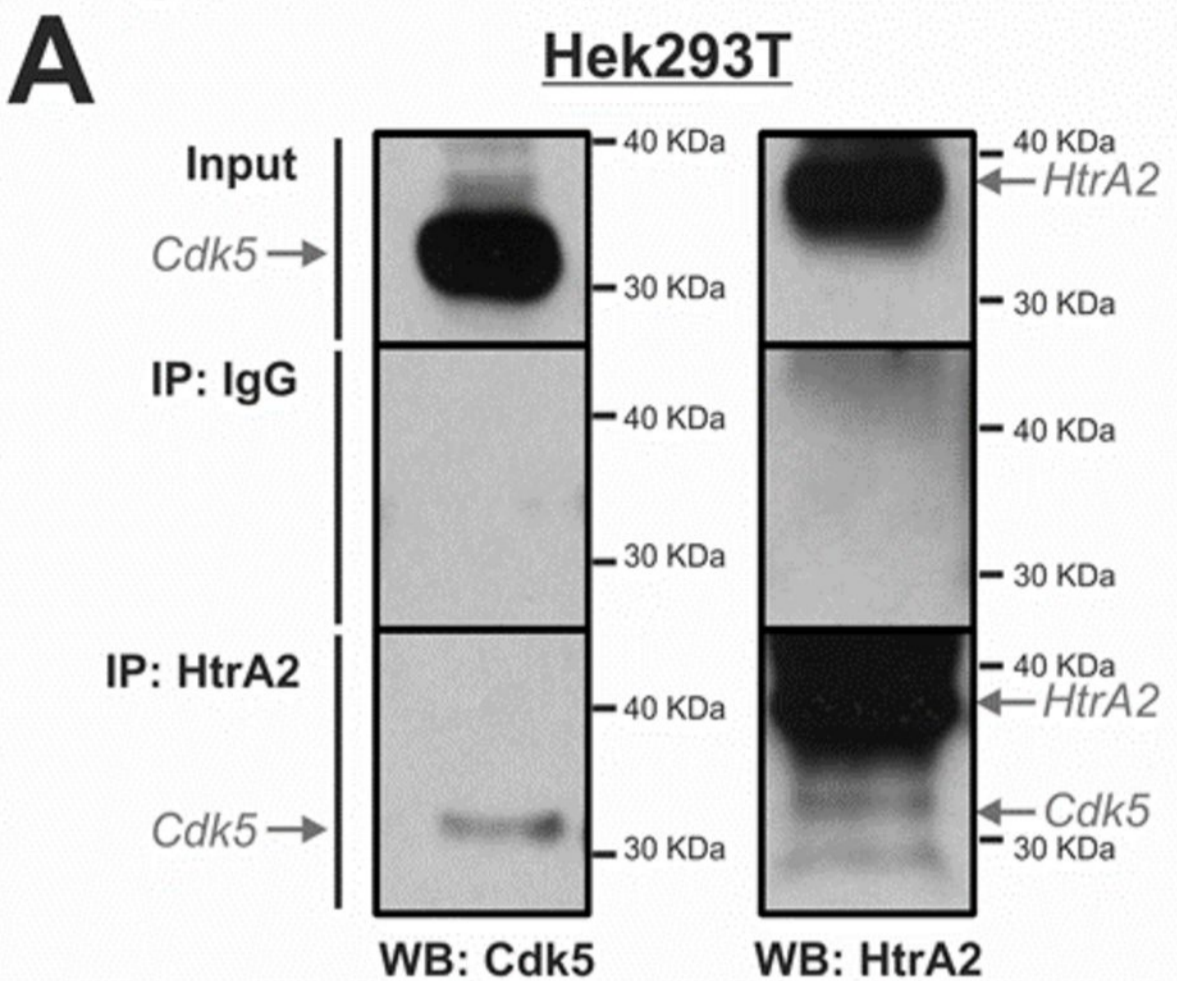



# Figure 2

## A

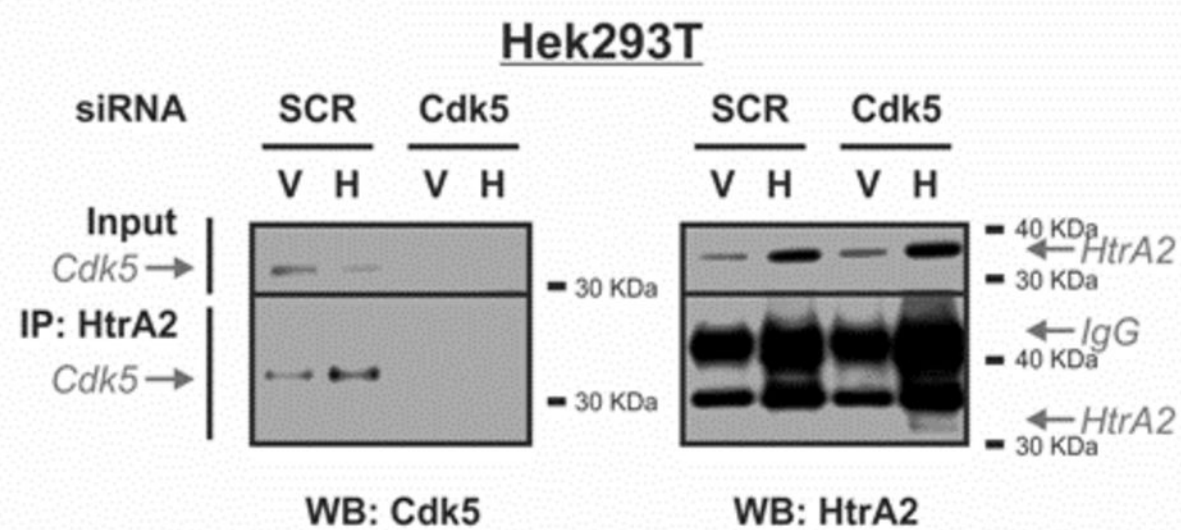

## B

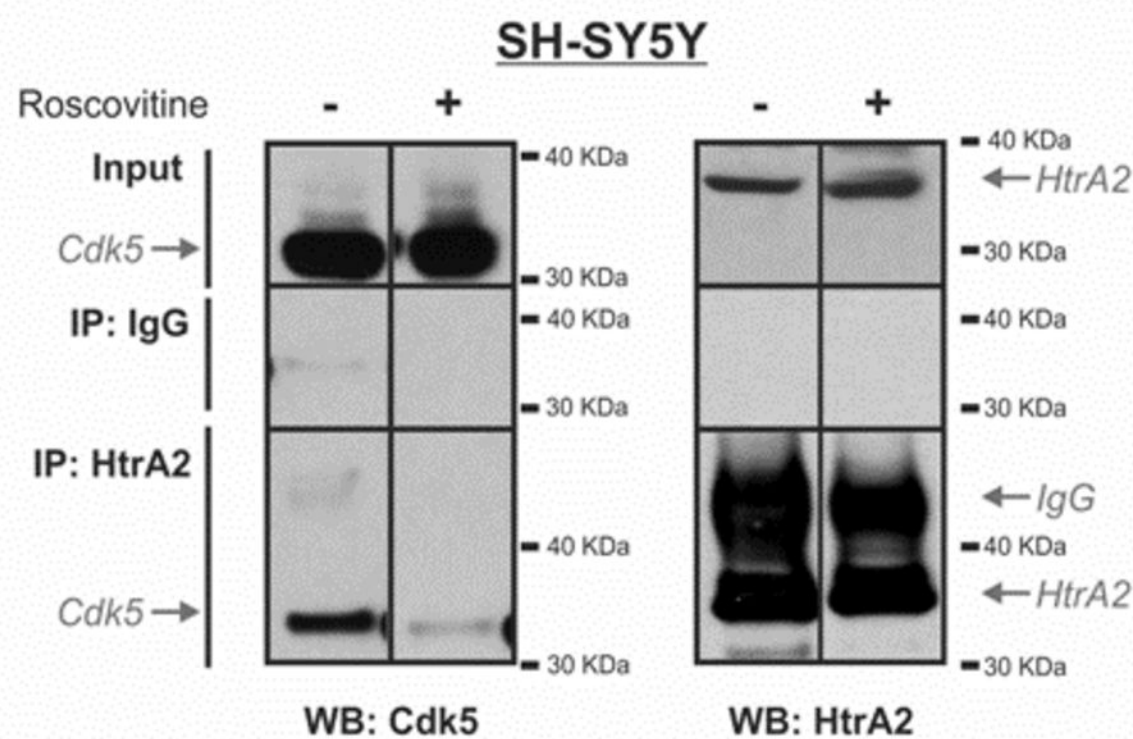

## C

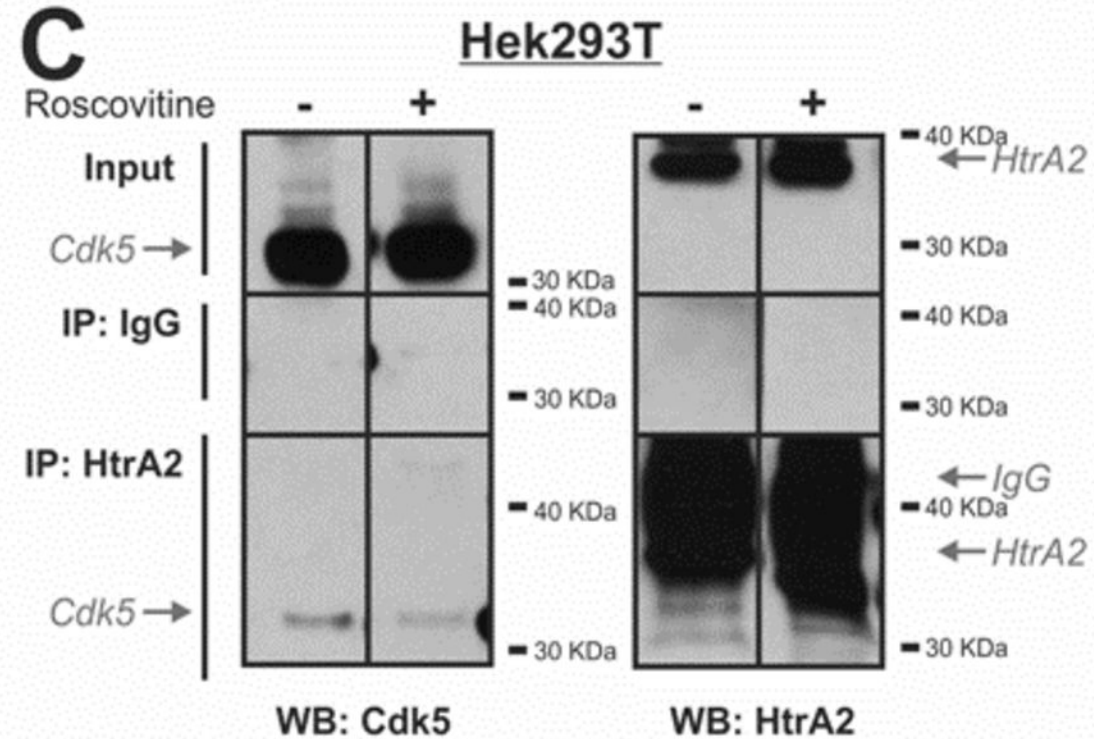

## D

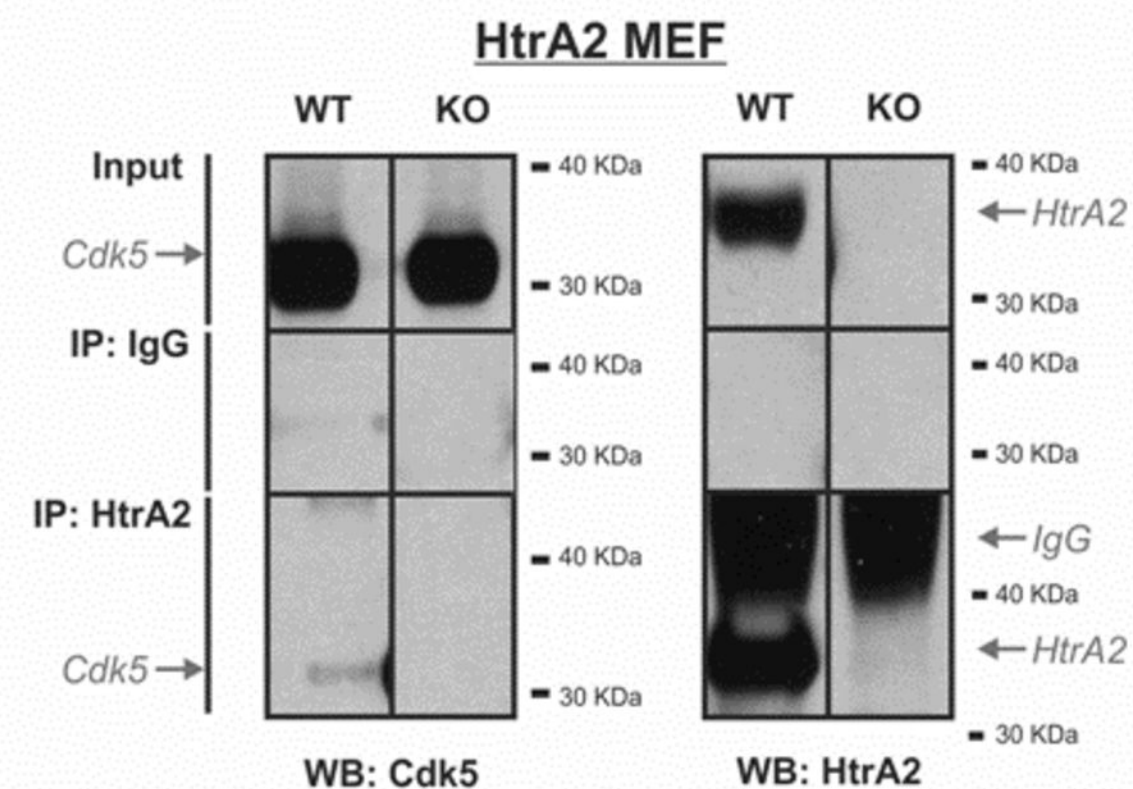

## E

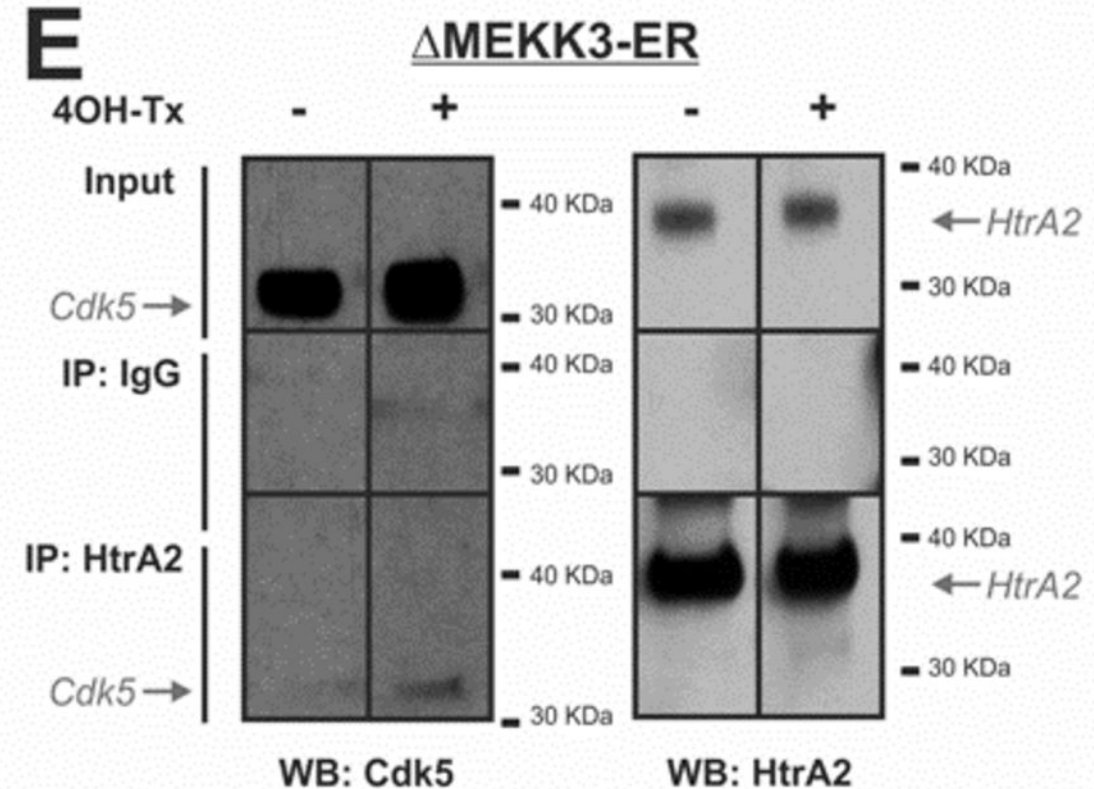

# Figure 3

## A

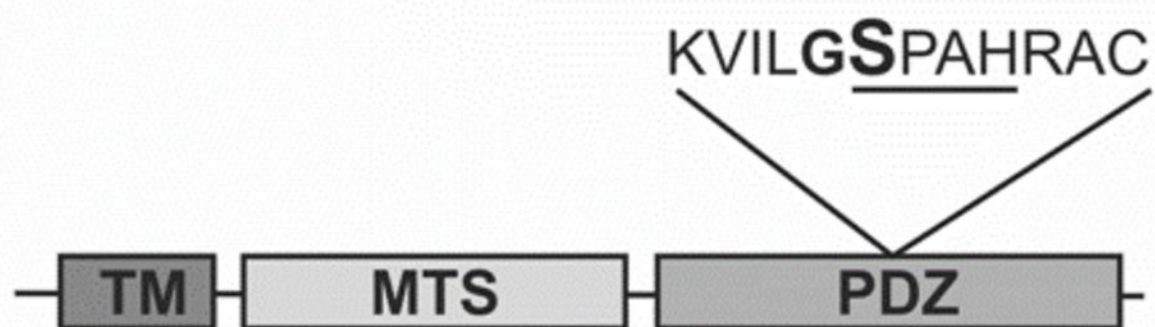

## B

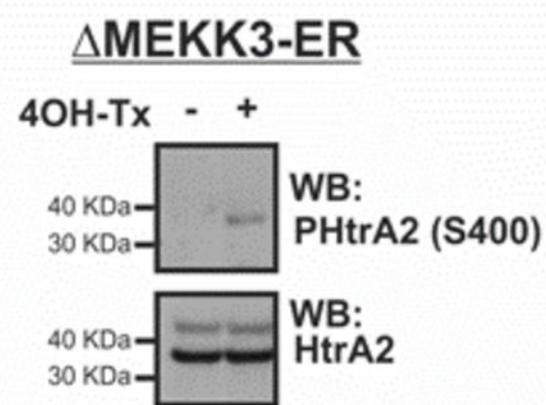

## C

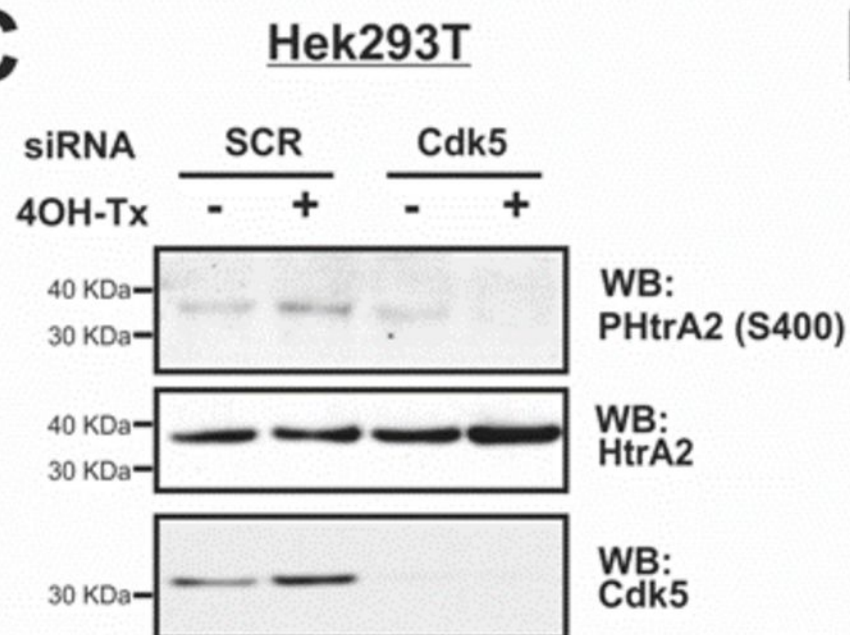

## D

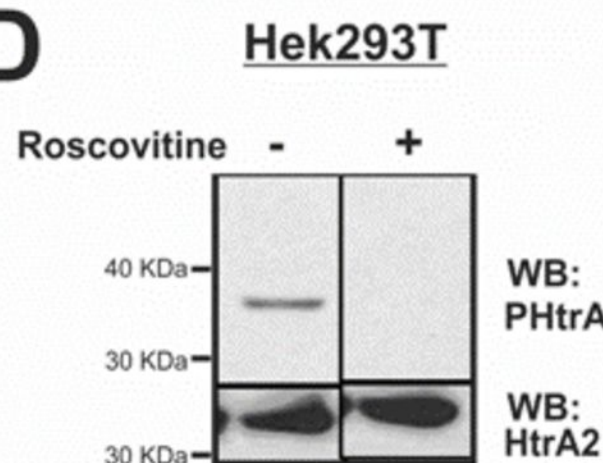

## E

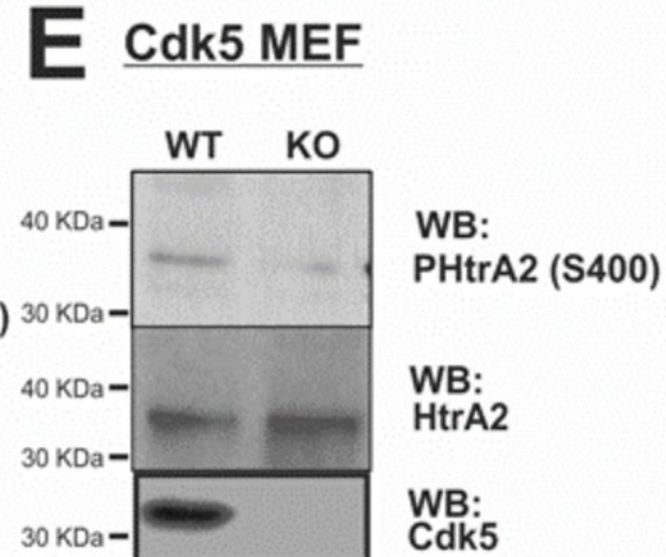

## F

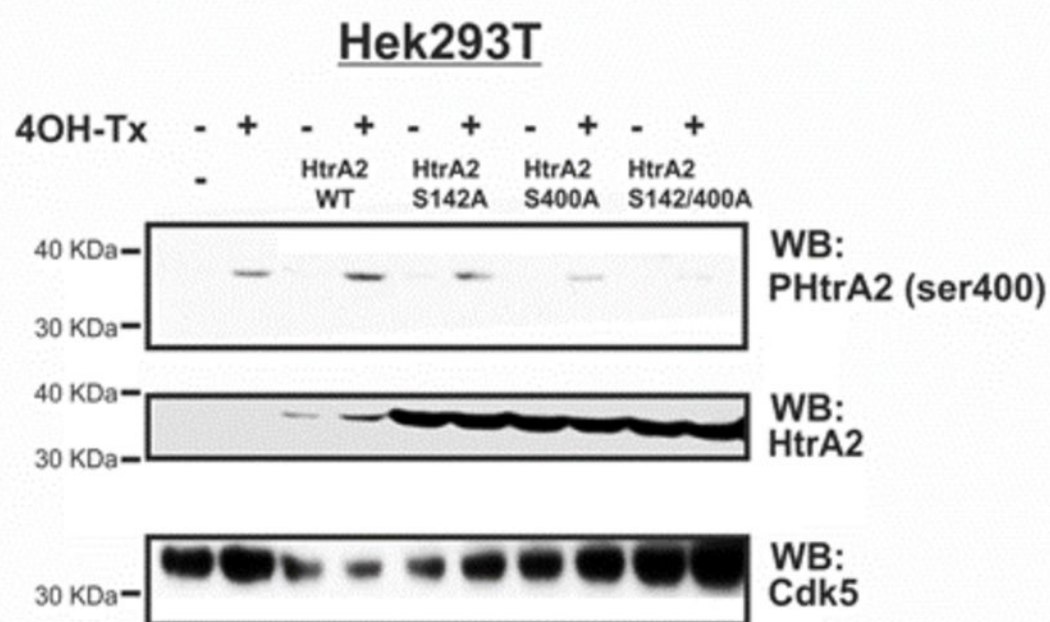

## G



# Figure 4

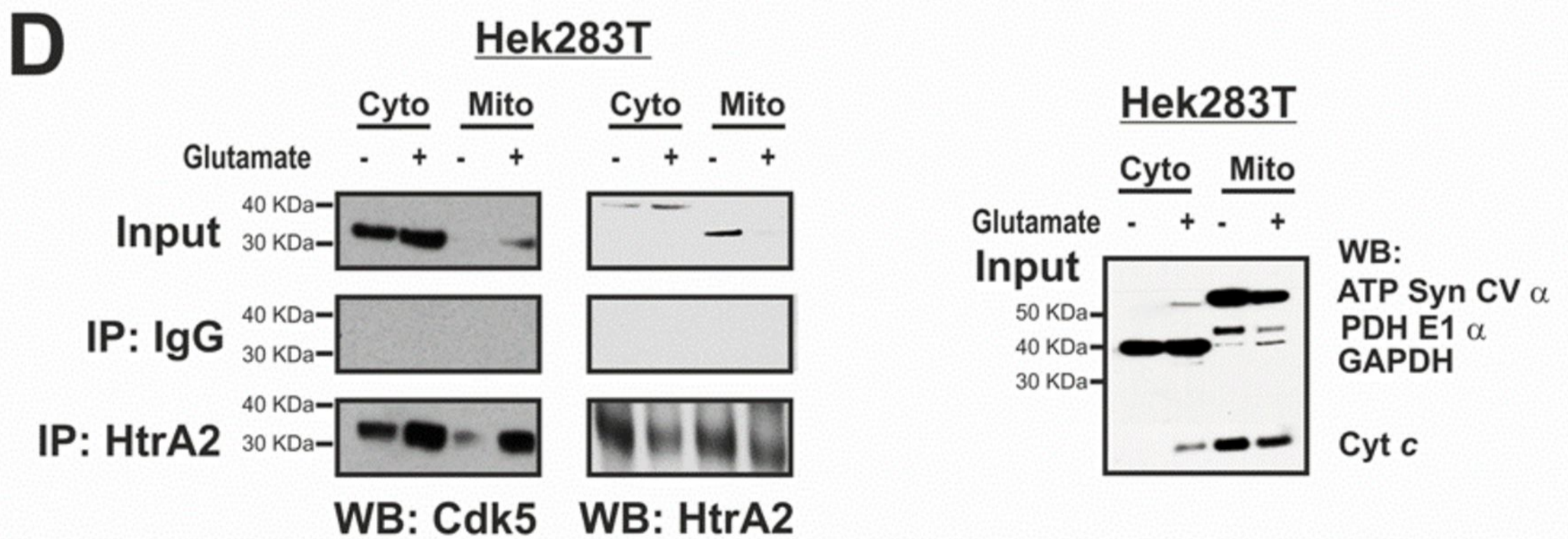
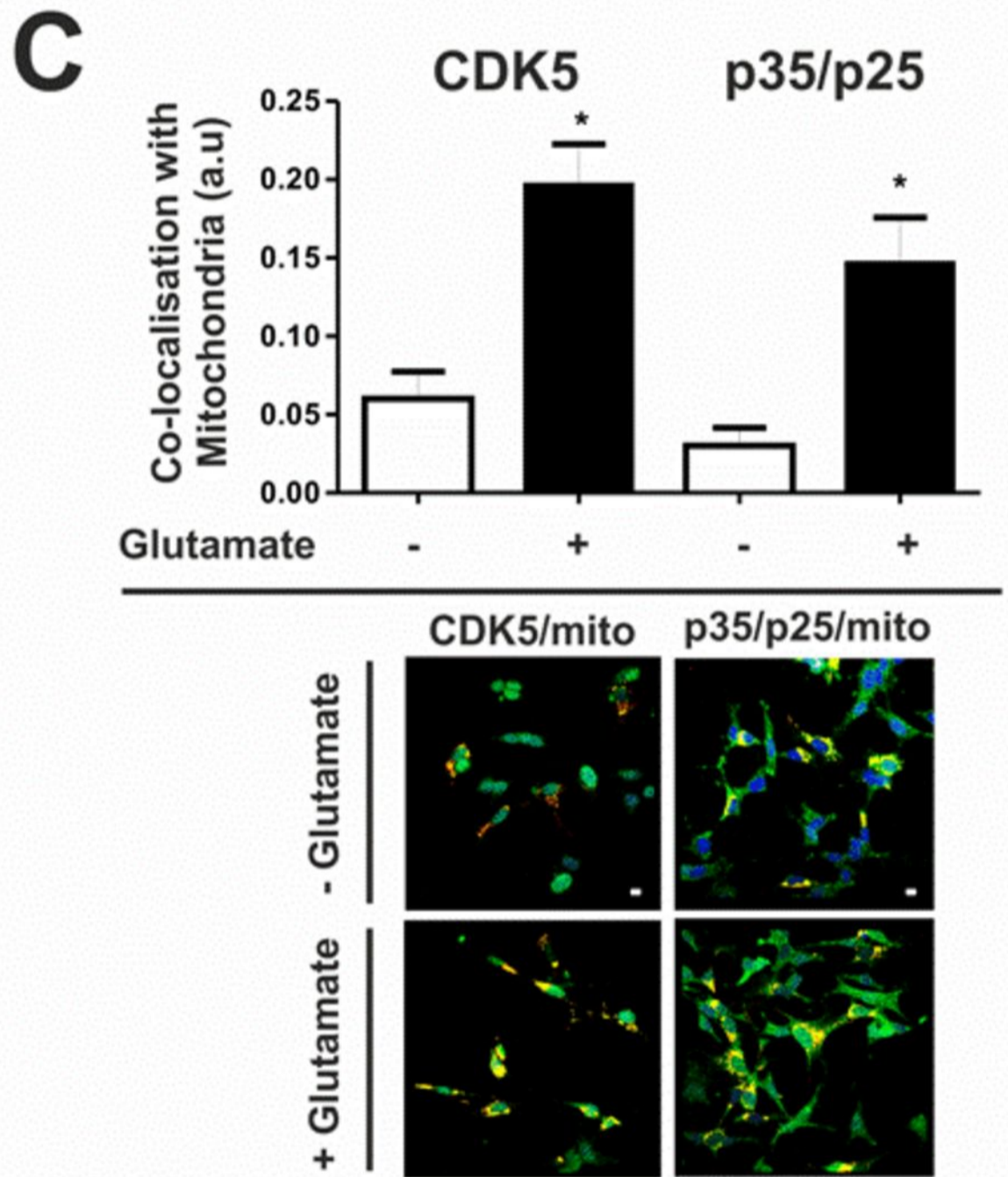
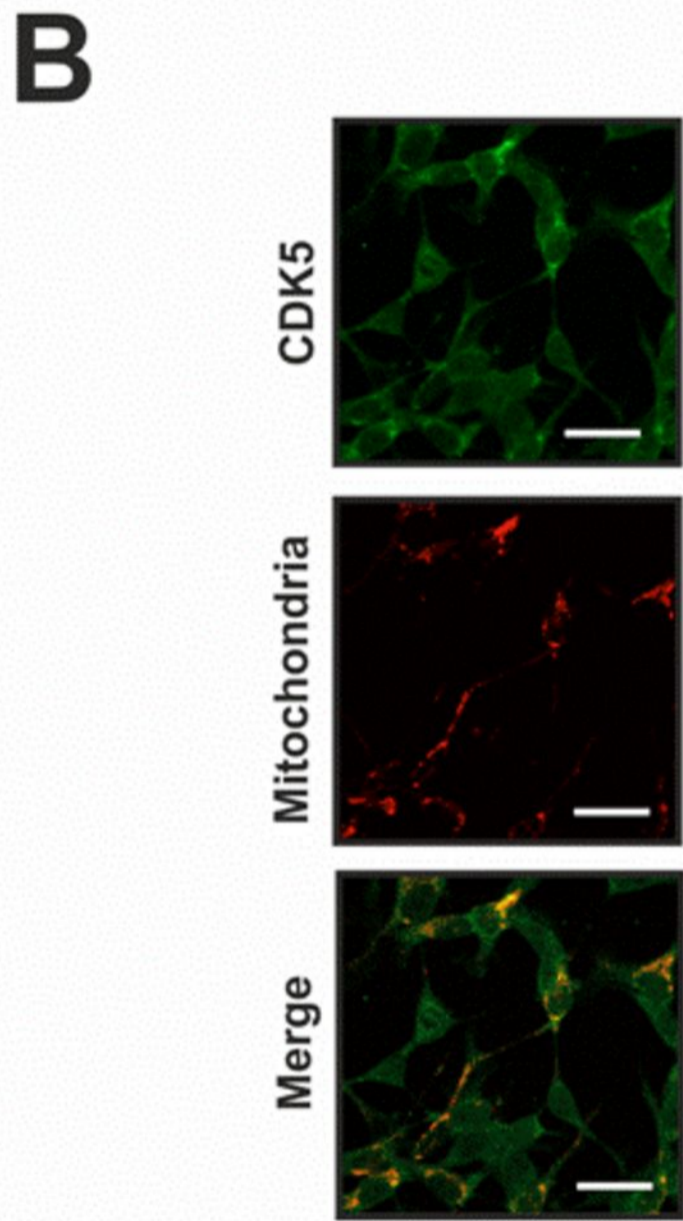
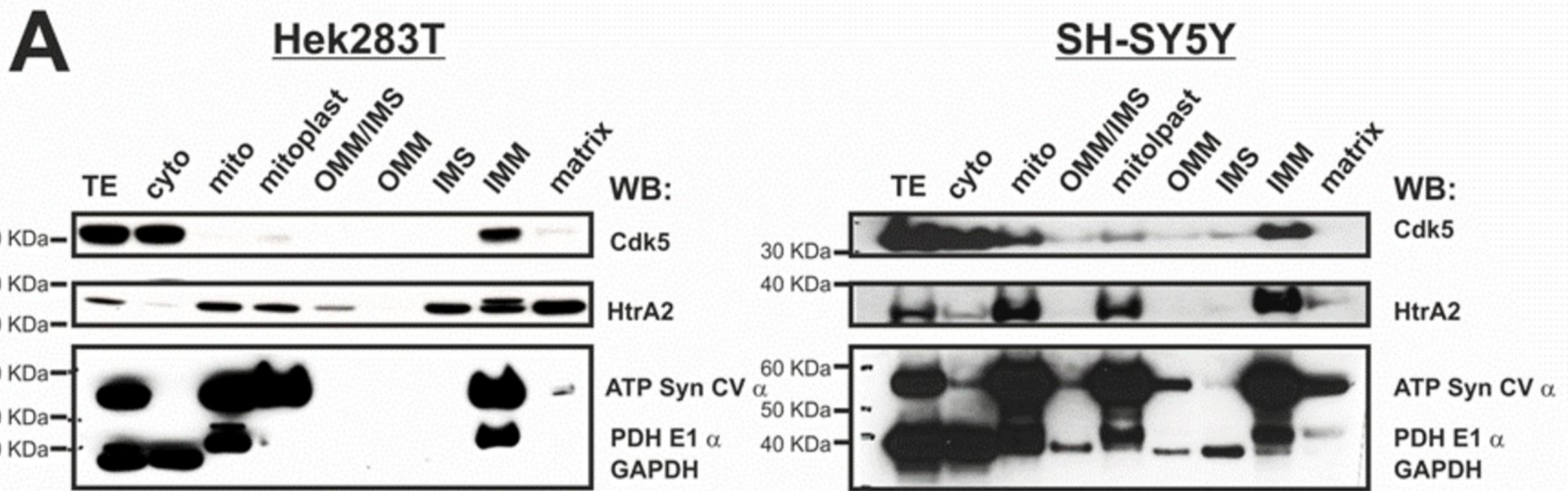

# Figure 5

## A

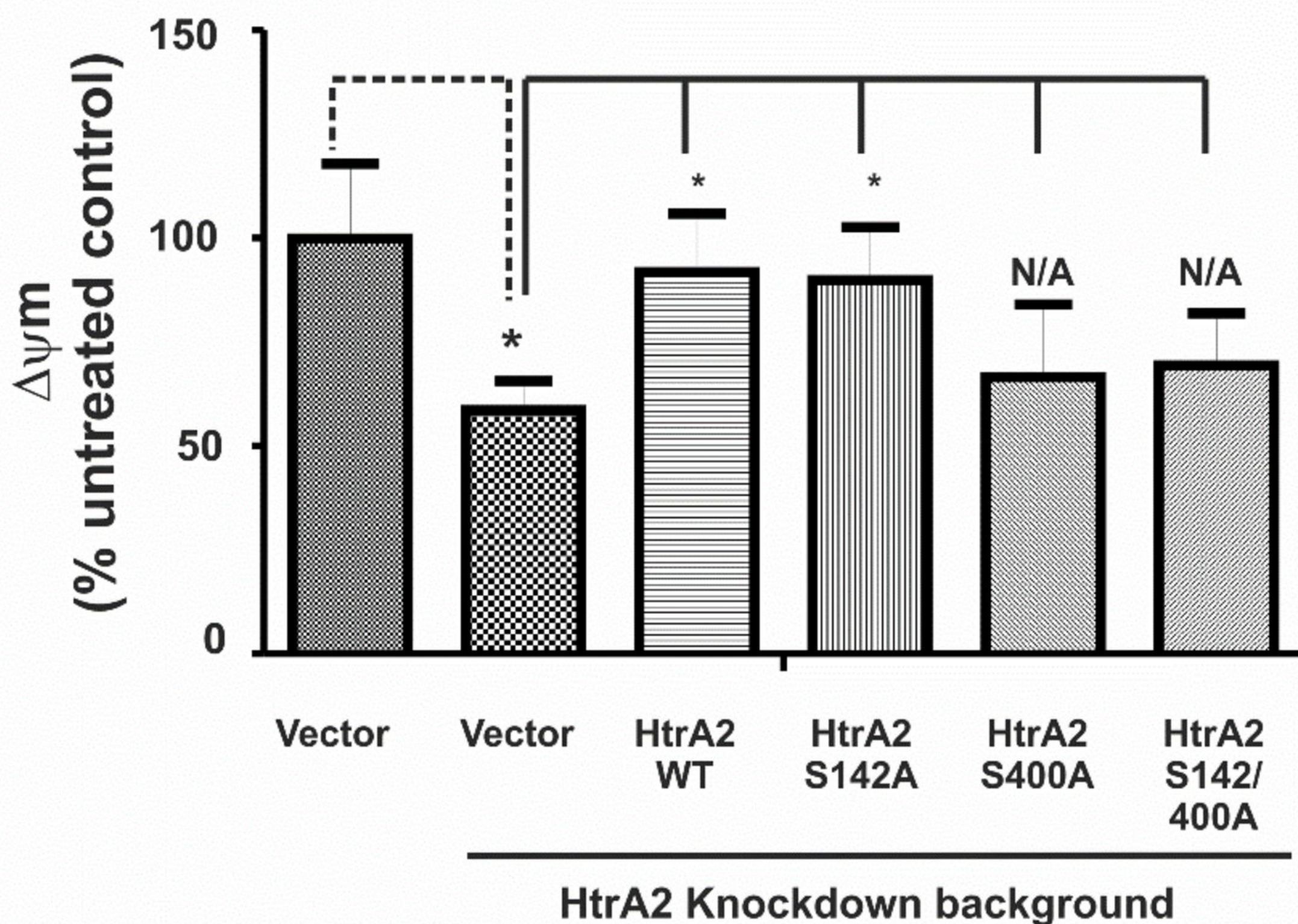

## B

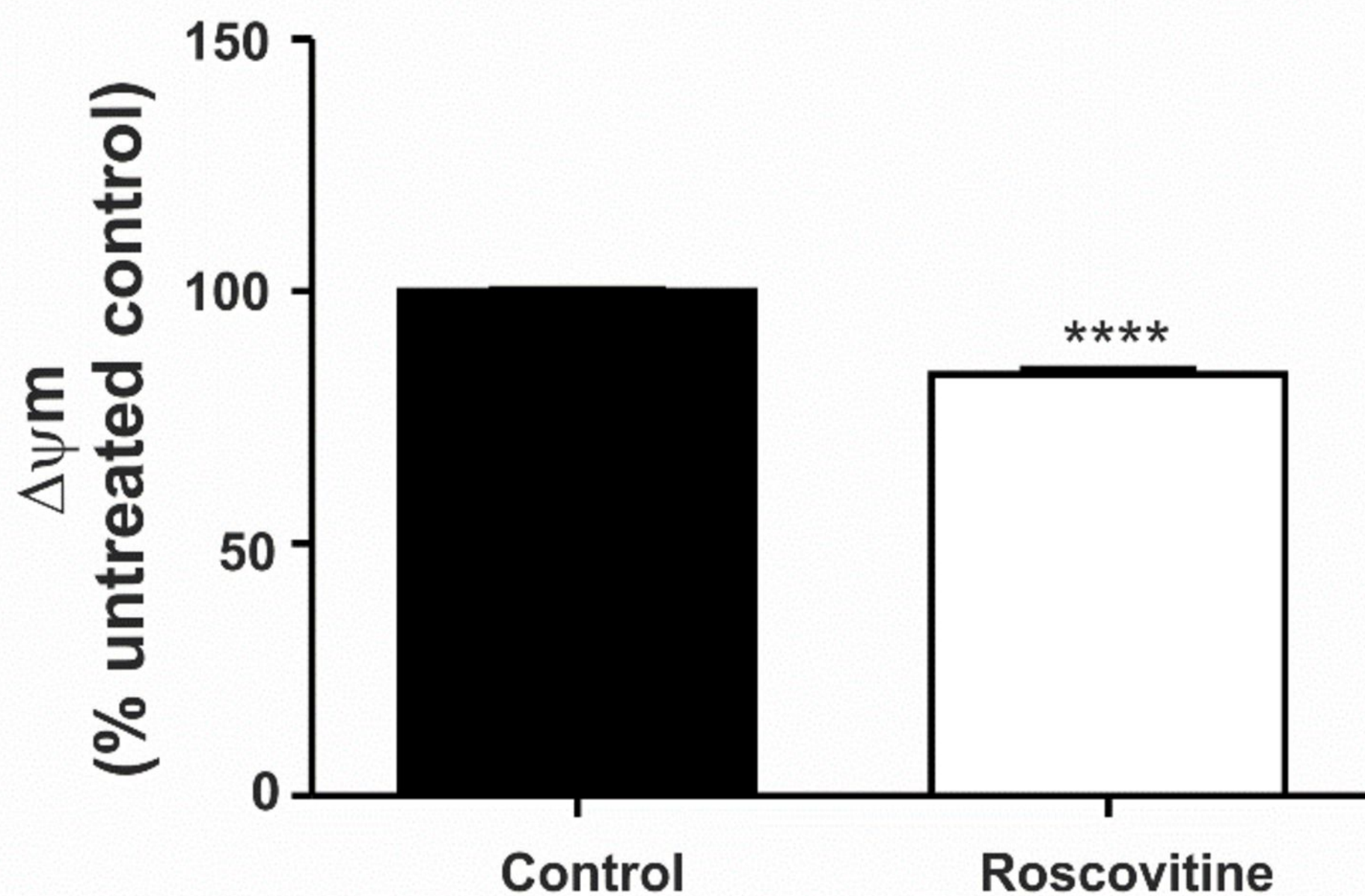

# Figure S1

## A

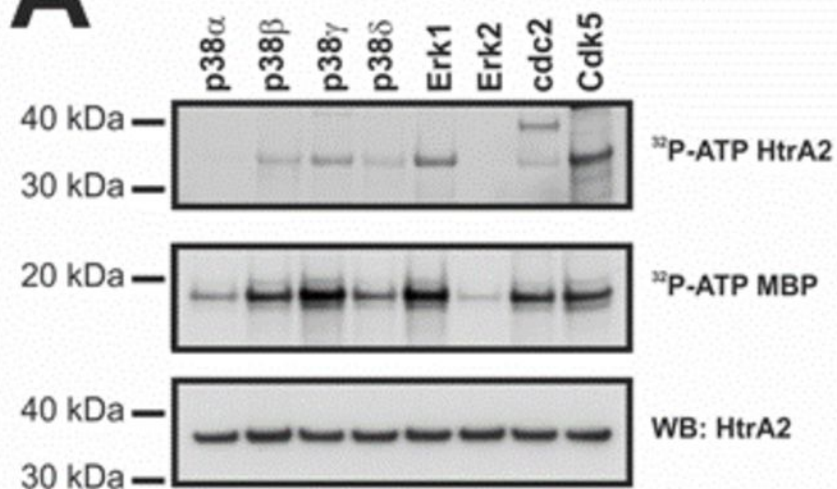

## B

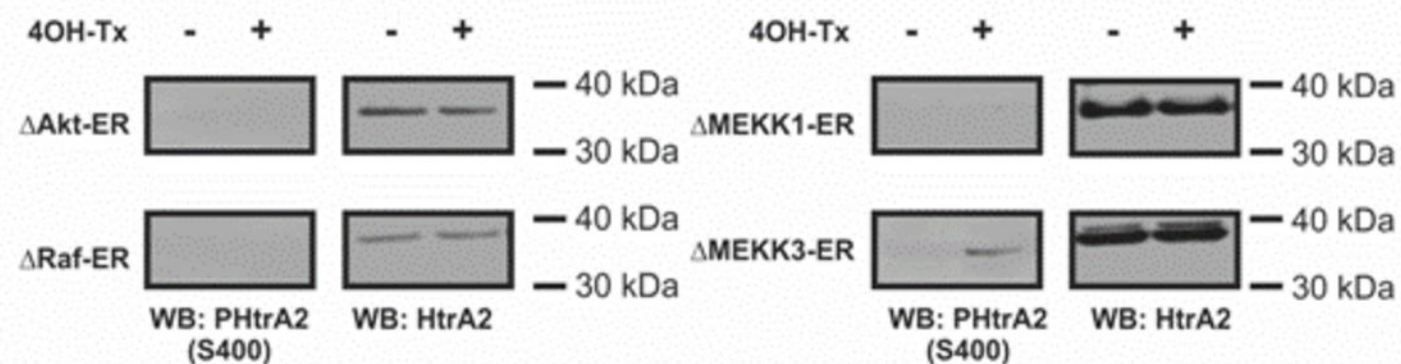

## C

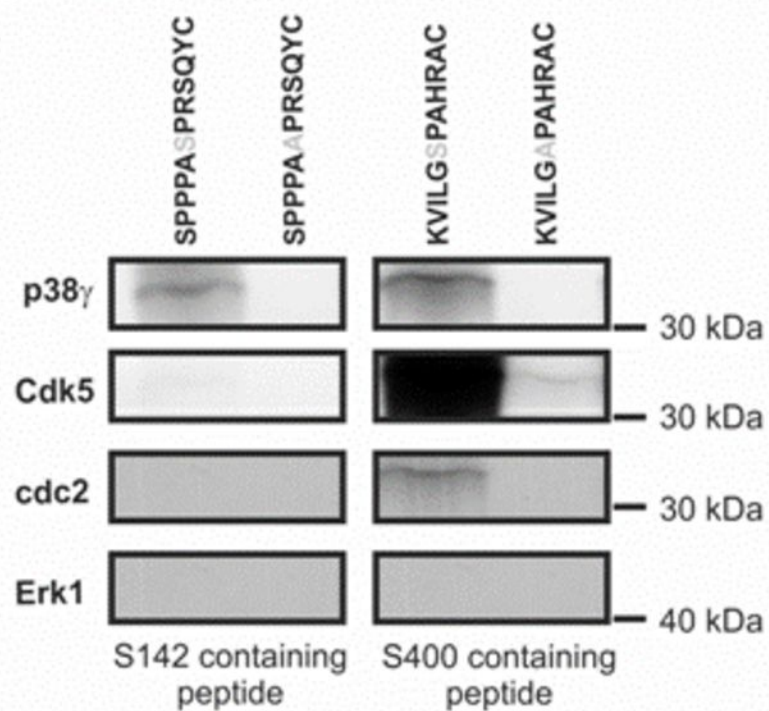

## D

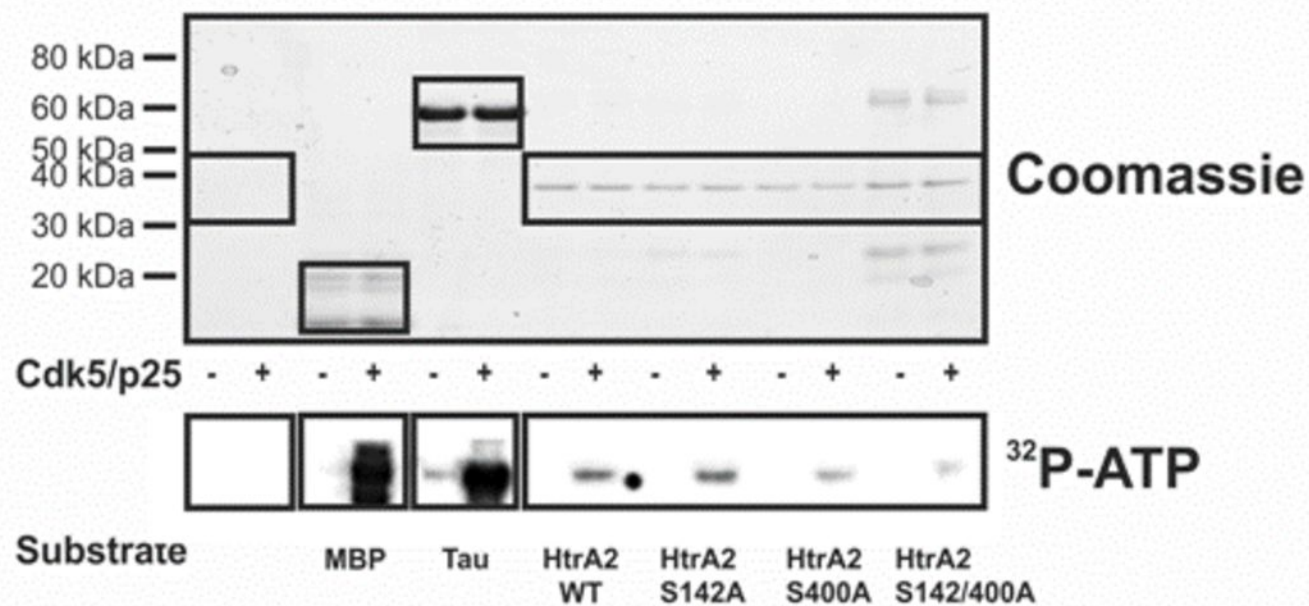

# Figure S2

## A

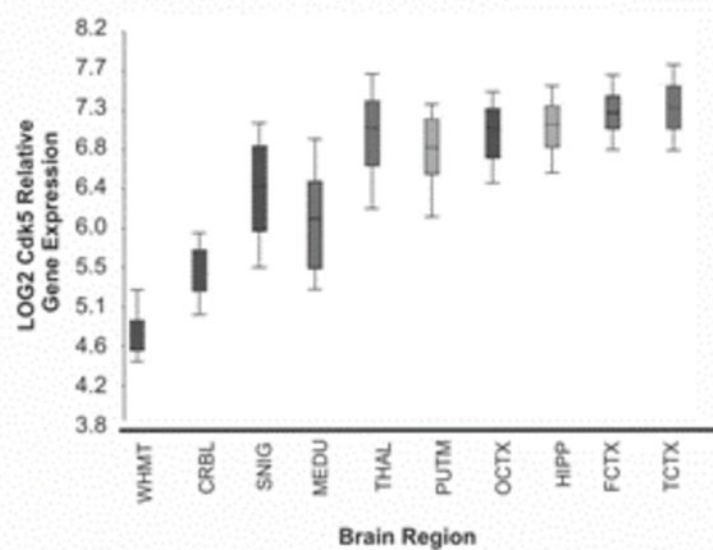

## B

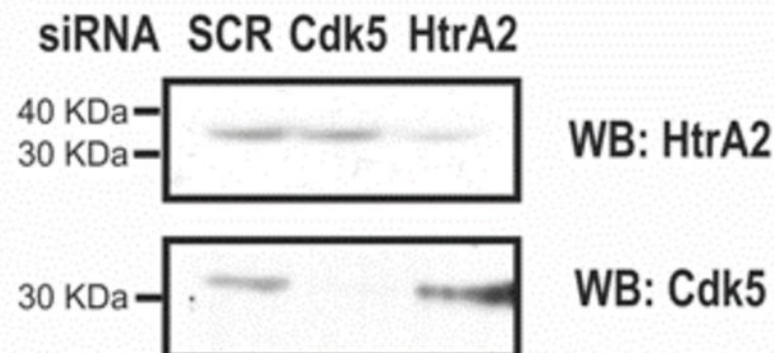

## C

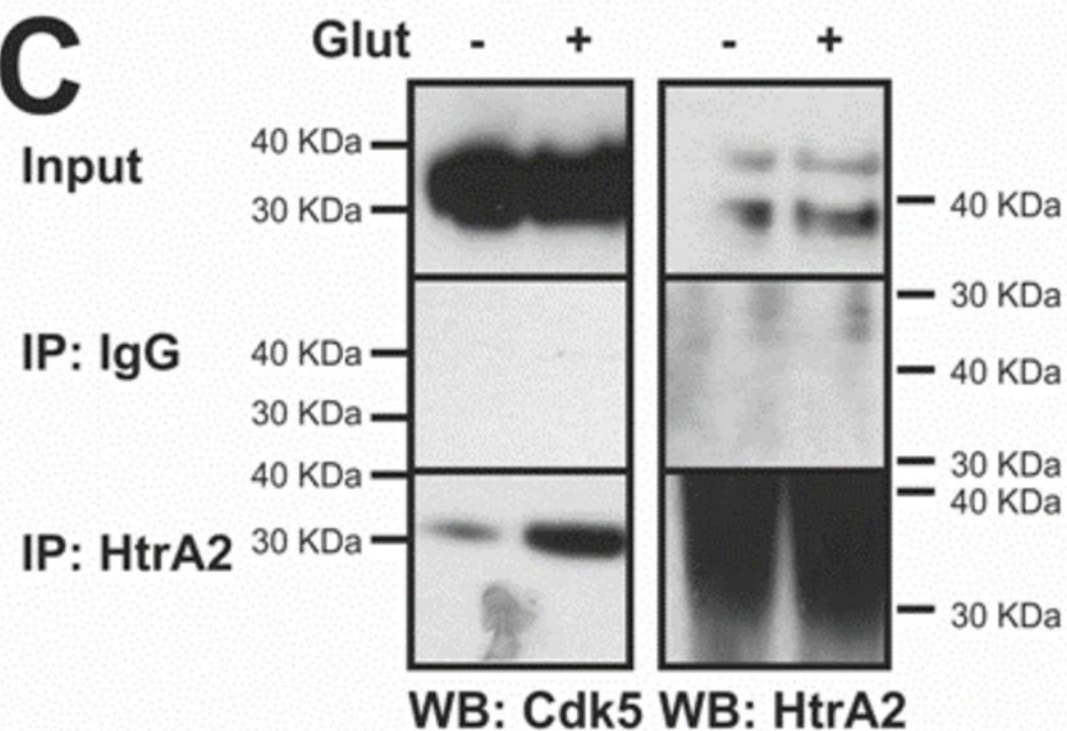

## D

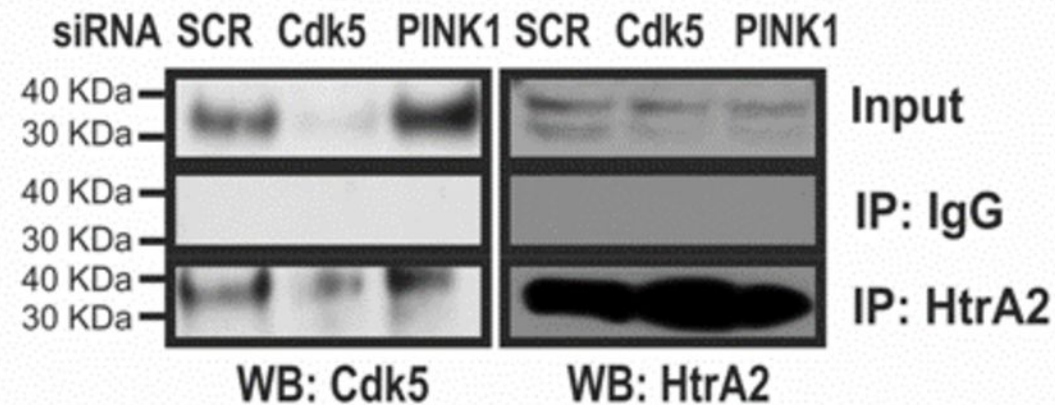

## E

