



HAL
open science

Cohomology of Deligne-Lusztig varieties for short-length regular elements in exceptional groups

Olivier Dudas

► **To cite this version:**

Olivier Dudas. Cohomology of Deligne-Lusztig varieties for short-length regular elements in exceptional groups. 2011. hal-00654558

HAL Id: hal-00654558

<https://hal.science/hal-00654558>

Preprint submitted on 22 Dec 2011

HAL is a multi-disciplinary open access archive for the deposit and dissemination of scientific research documents, whether they are published or not. The documents may come from teaching and research institutions in France or abroad, or from public or private research centers.

L'archive ouverte pluridisciplinaire **HAL**, est destinée au dépôt et à la diffusion de documents scientifiques de niveau recherche, publiés ou non, émanant des établissements d'enseignement et de recherche français ou étrangers, des laboratoires publics ou privés.

Cohomology of Deligne-Lusztig varieties for short-length regular elements in exceptional groups

Olivier Dudas^{*†}

December 22, 2011

Abstract

We determine the cohomology of Deligne-Lusztig varieties associated to some short-length regular elements for split groups of type F_4 and E_n . As a byproduct, we obtain conjectural Brauer trees for the principal Φ_{14} -block of E_7 and the principal Φ_{24} -block of E_8 .

Introduction

Let G be a finite group and ℓ be a prime number. The ℓ -modular representation theory of G is somehow controlled by the representation theory of local subgroups, namely the ℓ -subgroups of G and their normalisers. Broué's abelian defect conjecture is one of the major open problems in this framework: it predicts that an ℓ -block of G with abelian defect group is derived equivalent to its Brauer correspondent. From the work of Rickard [24], we know that such an equivalence should be induced by a perfect complex. Unfortunately, there is no canonical construction in general.

When $G = \mathbf{G}^F$ is a finite reductive group, Broué's suggested that the complex representing the cohomology of some Deligne-Lusztig variety should be a good candidate. Together with Michel in [3], they made precise which specific Deligne-Lusztig varieties would be associated to principal Φ_d -blocks when d is a regular number. They introduced the notion of *good d -regular elements* $w \in W$ and conjectured that

- for $i \neq j$, the groups $H_c^i(X(w), \overline{\mathbb{Q}}_\ell)$ and $H_c^j(X(w), \overline{\mathbb{Q}}_\ell)$ have no irreducible constituents in common;

^{*}Oxford Mathematical Institute.

[†]The author is supported by the EPSRC, Project No EP/H026568/1 and by Magdalen College, Oxford.

- the irreducible constituents of $H_c^*(X(w), \overline{\mathbb{Q}}_\ell)$ are exactly the unipotent characters lying in the principal Φ_d -block;
- the endomorphism algebra $\text{End}_{\mathbb{G}^F}(H_c^*(X(w), \overline{\mathbb{Q}}_\ell))$ is a d -cyclotomic Hecke algebra.

As for now, these statements have been verified in very few cases only. Computing the cohomology of a Deligne-Lusztig variety is a difficult problem, and the only results in this direction have been obtained by Lusztig in [20] when d is the Coxeter number (that is when w is a Coxeter element of W), for groups of rank 2 by Digne, Michel and Rouquier in [11] and for $d = n$ in type A_n and $d = 4$ in type D_4 by Digne and Michel in [9]. The purpose of this paper is to provide new examples for exceptional groups and in the spirit of Broué's conjecture, to deduce structural properties of the corresponding Φ_d -block.

We shall adapt Lusztig's strategy: if a character is non-cuspidal then it should appear in the cohomology of a certain quotient of the Deligne-Lusztig variety $X(w)$. In the Coxeter case, Lusztig proved that this quotient can be expressed in terms of a Deligne-Lusztig variety associated to a "smaller" Coxeter element, providing an inductive method to compute the cohomology of $X(w)$. The first step towards our main result is to show an analogous property for the d -regular elements we are interested in. To this end we will make extensive use of [14]. Unfortunately, this will not give enough information to deal with non-principal series. In order to compute the cuspidal part of the cohomology of $X(w)$, we shall, as in [20], introduce compactifications of $X(w)$. Unlike the Coxeter case, the cuspidal part of $H_c^*(X(w), \overline{\mathbb{Q}}_\ell)$ might not be concentrated in degree $\ell(w)$ since some of the divisors of $\overline{X}(w)$ might provide cuspidal characters. However, the results in [11] are sufficient to determine explicitly in which groups they actually appear and we obtain the following result:

Theorem. *Let w be a good d -regular element. Then the contribution of the principal series and the discrete series to the cohomology of the Deligne-Lusztig variety $X(w)$ is explicitly known in the following cases:*

- (\mathbf{G}, F) has type F_4 and $d = 8$;
- (\mathbf{G}, F) has type E_6 and $d = 9$;
- (\mathbf{G}, F) has type E_7 and $d = 14$;
- (\mathbf{G}, F) has type E_8 and $d = 24$.

We will also obtain partial results for the other series, as well as predictions on their contribution, in line with the formula given by Craven in [6].

Using Lusztig's results in the Coxeter case, Hiss, Lübeck and Malle have conjectured that the Brauer tree of the principal Φ_h -block can be read off the cohomology of the Coxeter variety [19]. Using the existing Brauer trees and the previous theorem, we propose conjectural planar embedded Brauer trees for the principal Φ_{14} -block of E_7 and for the principal Φ_{24} -block of E_8 (see Figure 3 and 4). We believe that a further study of the cohomology of the corresponding

Deligne-Lusztig varieties as in [12], [13] and [15] should give credit to these predictions.

1 Methods for determining the cohomology

Let \mathbf{G} be a connected reductive group, together with a Frobenius F defining a \mathbb{F}_q -structure on \mathbf{G} . If \mathbf{H} is any F -stable algebraic subgroup of \mathbf{G} , we will denote by H the finite group of fixed points \mathbf{H}^F . We fix a Borel subgroup \mathbf{B} containing a maximal torus \mathbf{T} of \mathbf{G} such that both \mathbf{B} and \mathbf{T} are F -stable. The associated Weyl group is $W = N_{\mathbf{G}}(\mathbf{T})/\mathbf{T}$ and the set of simple reflections will be denoted by S . We will assume that (\mathbf{G}, F) is split, so that F acts trivially on W .

Recall from [7] that to any element $w \in W$ one can associate a *Deligne-Lusztig variety*

$$X(w) = \{g\mathbf{B} \in \mathbf{G}/\mathbf{B} \mid g^{-1}Fg \in \mathbf{B}w\mathbf{B}\}.$$

It is a quasi-projective variety of pure dimension $\ell(w)$, on which G acts by left multiplication. This definition has been subsequently generalized in [3] to elements of the Artin-Tits monoid B^+ .

The ℓ -adic cohomology of $X(w)$ carries a lot of information on ordinary and modular representations of G . Throughout this paper, we will be interested in the case where w is a good d -regular element, or equivalently when w is a d -root of $\pi = \mathbf{w}_0^2$ in the Braid group of W . In that case, it is conjectured that the cohomology of $X(w)$ gives a good model for the unipotent part of the principal Φ_d -block (see for example [3] and [2] or the introduction for more details).

1.1 Non-cuspidal characters

To any subset $I \subset S$ one can associate a standard parabolic subgroup \mathbf{P}_I containing \mathbf{B} and a standard Levi subgroup \mathbf{L}_I containing \mathbf{T} . If \mathbf{U}_I denotes the unipotent radical of \mathbf{P}_I , the parabolic subgroup decomposes as $\mathbf{P}_I = \mathbf{L}_I\mathbf{U}_I$ and both \mathbf{L}_I and \mathbf{U}_I are F -stable. By [17, XVII, 6.2.5], the U_I -invariant part of the cohomology of $X(w)$ is isomorphic to the cohomology of $U_I \backslash X(w)$. Consequently, one can detect the presence of non-cuspidal modules in the cohomology of $X(w)$ by studying the quotient variety $U_I \backslash X(w)$ for various subsets I . In some specific cases, we can express such a quotient (or at least its cohomology) by means of smaller Deligne-Lusztig varieties.

Let $\mathbf{b} = \mathbf{w}_1 \cdots \mathbf{w}_r \in B^+$ be an element of the Braid monoid, written as a product of reduced elements (i.e. $w_i \in W$). Recall from [14] that the decomposition of \mathbf{G}/\mathbf{B} into \mathbf{P}_I -orbits induces a decomposition of $X(\mathbf{b})$ into locally closed P_I -subvarieties, called *pieces*

$$X_{(W_I x_1, \dots, W_I x_r)}(\mathbf{b}) = X(\mathbf{b}) \cap (\mathbf{P}_I x_1 \mathbf{B}/\mathbf{B} \times \cdots \times \mathbf{P}_I x_r \mathbf{B}/\mathbf{B})$$

where each x_i runs over the set of I -reduced elements of W . When I and \mathbf{b} are clear from context, we shall simply denote this variety by $X_{(x_1, \dots, x_r)}$. Throughout

this paper, we will make extensive use of a particular case of the main theorem of [14]. It can be deduced from [14, Remark 3.12] when each set I_i is empty and all the x_i 's are equal to the same element:

Theorem 1.1. *Let $\mathbf{b} = \mathbf{w}_1 \cdots \mathbf{w}_r \in B^+$ with $w_i \in W$, I be a subset of S and x be an I -reduced element of W . We assume that each w_i can be decomposed as $w_i = \gamma_i w'_i$ with $\gamma_i \in S \cup \{1\}$ and $w'_i \leq w_i$ be such that*

- (a) *if $\gamma_i = 1$ then $v_i = xw_i x^{-1} \in W_I$;*
- (b) *if $\gamma_i \in S$ then $x\gamma_i x^{-1} \notin W_I$, $v_i = xw'_i x^{-1} \in W_I$ and $\ell(w'_i) = \ell(v_i)$.*

Let d be the number of w_i 's satisfying condition (b) and $e = \sum \dim(\mathbf{U}_I^x \cap w'_i \mathbf{U} \cap \mathbf{U}^-)$. Then we have the following isomorphism of graded $L_I \times \langle F \rangle$ -modules:

$$H_c^\bullet(U_I \backslash X_{(x, \dots, x)}) \simeq H_c^\bullet((\mathbb{G}_m)^d \times X_{L_I}(\mathbf{v}_1 \cdots \mathbf{v}_r))[-2e](e).$$

Remark 1.2. In the particular cases we will be interested in, \mathbf{b} will always be reduced. In that case, it corresponds to an element $w \in W$ and we have $w = w_1 \cdots w_r$ with $\ell(w) = \ell(w_1) + \cdots + \ell(w_r)$. Note that in general the variety $X(\mathbf{b}) \subset (\mathbf{G}/\mathbf{B})^r$ can have much more pieces that $X(w) \subset \mathbf{G}/\mathbf{B}$, since

$$X_{W_I x}(w) = \bigcup_{\substack{x_2, \dots, x_r \\ I\text{-reduced}}} X_{(W_I x, W_I x_2, \dots, W_I x_r)}(\mathbf{b}).$$

However, in our specific examples we will observe that the piece $X_{(W_I x, W_I x_2, \dots, W_I x_r)}$ will be empty unless $x_2 = \cdots = x_r = x$, so that $X_x \simeq X_{(x, x, \dots, x)}$.

1.2 Cuspidal characters

By definition, cuspidal representations of G have no non-zero element invariant under the action of U_I unless $I = S$. In particular, the cohomology of the quotient variety $U_I \backslash X(w)$ contains no information on the cuspidal characters that can appear in $X(w)$. In this section we shall briefly review some methods developed in [9] and [11] in order to solve the problem of finding cuspidal characters in the cohomology of Deligne-Lusztig varieties.

Let $\mathbf{b} = \mathbf{w}_1 \cdots \mathbf{w}_r$ with $w_i \in W$. Recall that the variety $X(\mathbf{b})$ has a nice compactification

$$X(\underline{w}_1 \cdots \underline{w}_r) = \{(g_0, g_1, \dots, g_r) \in (\mathbf{G}/\mathbf{B})^{r+1} \mid g_{i-1}^{-1} g_i \in \overline{\mathbf{B}w_i \mathbf{B}} \text{ and } g_r^{-1} F(g_0) \in \mathbf{B}\}$$

which has the following properties (see [9] and [11]) :

Proposition 1.3. *Let w_1, \dots, w_r be elements of W ,*

- (i) *$X(\underline{w}_1 \cdots \underline{w}_r)$ is a projective variety of dimension $\ell(w_1) + \cdots + \ell(w_r)$;*
- (ii) *$X(\underline{w}_1 \cdots \underline{w}_r)$ is smooth whenever each variety $\overline{\mathbf{B}w_i \mathbf{B}}$ is;*
- (iii) *$X(\underline{w}_1 \cdots \underline{w}_r)$ is rationally smooth whenever each variety $\overline{\mathbf{B}w_i \mathbf{B}}$ is;*
- (iv) *$X(\underline{w}_1 \cdots \underline{w}_r)$ has a filtration by closed subvarieties $X(\underline{v}_1 \cdots \underline{v}_r)$ where the v_i 's satisfy $v_i \leq w_i$.*

Remark 1.4. A particular case is when each w_i is a simple reflection s_i . Then the variety $X(\underline{w}_1 \cdots \underline{w}_r)$ coincides with the smooth compactification introduced by Deligne and Lusztig in [7].

Let $w \in W$. In order to compute the cuspidal part of the cohomology of $X(w)$ using the previous compactifications, we will use the following results:

- (C1) the cohomology of $X(w)$ over $\overline{\mathbb{Q}}_\ell$ is zero outside the degrees $\ell(w), \dots, 2\ell(w)$ [11, Corollary 3.3.22];
- (C2) the following triangle is distinguished in $D^b(\overline{\mathbb{Q}}_\ell G\text{-Mod})$:

$$\mathrm{R}\Gamma_c(X(w), \overline{\mathbb{Q}}_\ell) \longrightarrow \mathrm{R}\Gamma_c(X(\underline{w}), \overline{\mathbb{Q}}_\ell) \longrightarrow \mathrm{R}\Gamma_c\left(\bigcup_{v < w} X(v), \overline{\mathbb{Q}}_\ell\right) \rightsquigarrow$$

- (C3) when $X(\underline{w})$ is rationally smooth, its cohomology as a graded $G \times \langle F \rangle_{\mathrm{mon}}$ -module can be explicitly computed using [11, Corollary 3.3.8];
- (C4) let ρ be a cuspidal representation of G that appears in the cohomology of a Deligne-Lusztig variety associated to a Coxeter element of W . If w itself is not a Coxeter element, any eigenvalue λ of F on $H_c^{\ell(w)}(X(w), \overline{\mathbb{Q}}_\ell)_\rho$ satisfy $|\lambda| < |q^{\ell(w)/2}|$. This is a particular case of [11, Proposition 3.3.21].

Note finally that the property of being rationally smooth of $X(w)$ can be read off the Kazhdan-Lusztig polynomials of W [11, proposition 3.2.5]. If $X(\underline{w})$ happens to be not rationally smooth, we can always decompose w into a product $w = w_1 \cdots w_r$ such that each variety $\overline{\mathbf{B}w_i\mathbf{B}}$ is.

2 Some particular cases

For short-length regular elements, one can observe that only a small number of pieces X_x are non-empty. In addition, they very often satisfy the assumptions of Theorem 1.1. For some of these elements, we can therefore compute explicitly the cohomology of the quotient $U_I \backslash X(w)$, and eventually deduce the cohomology of $X(w)$ using the results discussed in Section 1.2.

To make the computations easier, we shall use the notation introduced in [9]: the cohomology of the Deligne-Lusztig variety $X(w)$ as a graded $G \times \langle F \rangle_{\mathrm{mon}}$ -module will be represented by a polynomial $H_{X(w)}(t^{1/2}, h)$ with coefficients in the semi-group $\mathbb{N}\mathrm{Irr}G$. By a theorem of Lusztig, when ρ is a unipotent character, any eigenvalue of F on the ρ -isotypic part of $H_c^i(X(w), \overline{\mathbb{Q}}_\ell)$ can be written $\lambda_\rho q^{j/2}$, where λ_ρ is a root of unity independent of w and i . The multiplicity of ρ in $H_c^i(X(w), \overline{\mathbb{Q}}_\ell)$ with eigenvalue $\lambda_\rho q^{j/2}$ will be encoded by the coefficient of $h^i t^{j/2}$ in the polynomial $H_{X(w)}(t^{1/2}, h)$. For example, if $X(s)$ is the Drinfeld curve for $\mathbf{G} = \mathrm{SL}_2(\overline{\mathbb{F}}_p)$ then $H_{X(w)} = h\mathrm{St} + h^2 t \mathrm{Id}$.

Since we are dealing with exceptional Weyl groups, and more specifically with the combinatorics of distinguished subexpressions, we will use the package CHEVIE in GAP. We have written a couple of useful functions to determine

whether a piece of a Deligne-Lusztig variety is non-empty, and to describe it that case its quotient by a finite unipotent group. These functions can be found in [22] (or will be soon available) under the name `deodhar.g`.

2.1 8-regular elements for groups of type F_4

Let (\mathbf{G}, F) be a split group of type F_4 . To fix the notation we will consider the following Dynkin diagram:

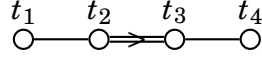

where t_1, t_2, t_3 and t_4 are the simple reflections.

Recall that there exist d -regular elements for $d \in \{1, 2, 3, 4, 6, 8, 12\}$ only (see for example [25]). Note that the largest integer corresponds to the Coxeter number. By [3], for any such d one can find a particular d -regular element which is a d -th root of π in the Braid monoid. By [1, 11.22] and [10, Proposition 5.5], the cohomology of the corresponding Deligne-Lusztig variety does not depend on the choice of a root. For our purposes we will take

$$w = t_1 t_2 t_3 t_2 t_3 t_4.$$

2.1.1. Cohomology of $U_I \backslash X(w)$. We start by computing the cohomology of the quotient $U_I \backslash X(w)$ where $I = \{t_2, t_3\}$. Using the criterion given in [9, Lemma 8.3] and the package CHEVIE in GAP one can check that there are only three non-empty pieces X_x , corresponding to the cosets $W_I x = W_I w_0$, $W_I w_0 t_1 t_2$ and $W_I w_0 t_4 t_3$. Theorem 1.1 does not apply directly to all of these cells, but we can add an intermediate step. Let $J = \{t_2, t_3, t_4\}$ and $K = \{t_1, t_2, t_3\}$. We have $W_J w_0 = W_J w_0 t_4 t_3$ (resp. $W_K w_0 = W_K w_0 t_1 t_2$) whereas $X_{W_I w_0 t_1 t_2} = X_{W_J w_0 t_1 t_2}$ (resp. $X_{W_J w_0 t_4 t_3}$) is stable by P_J (resp. P_K). Therefore only two pieces appear in the decomposition of $U_J \backslash X(w)$ (resp. $U_K \backslash X(w)$).

- Let y be the minimal element of $W_J w_0 t_1 t_2$. Since $t_1 t_2$ is J -reduced, $y = w_J w_0 t_1 t_2$. Let us decompose w as $w = w_1 w_2$ with $w_1 = t_1 t_2 t_3 t_2$ and $w_2 = t_3 t_4 = t_3 w'_2$. We have ${}^y w_1 = t_2 t_3 \in W_J$ and ${}^y w'_2 = t_4$ and therefore we can apply Theorem 1.1 to compute the cohomology of the piece of $X(\mathbf{w}_1 \mathbf{w}_2)$ corresponding to $(W_J y, W_J y)$. Furthermore, one can check (using GAP again) that the pieces corresponding to $(W_J y, W_J y')$ are empty unless y and y' lie in the same coset. In particular, $X_{W_J y}(w) \simeq X_{W_J y, W_J y}(\mathbf{w}_1 \mathbf{w}_2)$ and

$$H_c^\bullet(X_{W_J y}, \overline{\mathbb{Q}}_\ell)^{U_J} \simeq H_c^\bullet(\mathbb{G}_a \times \mathbb{G}_m \times X_{\mathbf{L}_J}(t_2 t_3 t_4), \overline{\mathbb{Q}}_\ell).$$

Now $X_{\mathbf{L}_J}(t_2 t_3 t_4)$ is a Deligne-Lusztig variety associated to a Coxeter element, and therefore the cohomology of its quotient by $U_I \cap \mathbf{L}_J$ is given by [20, Corollary 2.10]. We obtain

$$\begin{aligned} H_c^\bullet(X_{W_I w_0 t_1 t_2}, \overline{\mathbb{Q}}_\ell)^{U_I} &\simeq (H_c^\bullet(\mathbb{G}_a \times \mathbb{G}_m \times X_{\mathbf{L}_J}(t_2 t_3 t_4), \overline{\mathbb{Q}}_\ell))^{U_I \cap \mathbf{L}_J} \\ &\simeq H_c^\bullet(\mathbb{G}_a \times (\mathbb{G}_m)^2 \times X_{\mathbf{L}_I}(t_2 t_3), \overline{\mathbb{Q}}_\ell). \end{aligned}$$

- For the piece $X_{W_I w_0 t_4 t_3}$ we proceed as above: the minimal element z of $W_K w_0 t_4 t_3$ is clearly $z = w_K w_0 t_4 t_3$ since $t_4 t_3$ is K -reduced. We can decompose w as $w = w_1 w_2 w_3$ where $w_1 = t_1$, $w_2 = t_2 = t_2 w_2'$ and $w_3 = t_3 t_2 t_3 t_4$. We observe that ${}^z w_1 = t_1$, ${}^z w_2' = 1$ and ${}^z w_3 = t_2 t_3$ are elements of W_K . In addition, we can check by explicit computation that a piece of $X(\mathbf{w}_1 \mathbf{w}_2 \mathbf{w}_3)$ corresponding to $(W_K z, W_K z', W_K z'')$ is empty unless z, z' and z'' lie in the same coset. Consequently, we can apply Theorem 1.1 to relate the cohomology of $X_{W_K z}$ to the cohomology of $X_{\mathbf{L}_K}(t_1 t_2 t_3)$ and then use [20] to obtain

$$\begin{aligned} H_c^*(X_{W_I w_0 t_4 t_3}, \overline{\mathbb{Q}}_\ell)^{U_I} &\simeq (H_c^*(\mathbb{G}_a \times \mathbb{G}_m \times X_{\mathbf{L}_K}(t_1 t_2 t_3), \overline{\mathbb{Q}}_\ell)^{U_I \cap \mathbf{L}_K}) \\ &\simeq H_c^*(\mathbb{G}_a \times (\mathbb{G}_m)^2 \times X_{\mathbf{L}_I}(t_2 t_3), \overline{\mathbb{Q}}_\ell). \end{aligned}$$

- For the open piece $X_{W_I w_0}$ we can directly apply Theorem 1.1 by decomposing w as $w = w_1 w_2$ with $w_1 = t_1(t_2 t_3 t_2 t_3)$ and $w_2 = t_4$. We only have to check that $X_{W_I w_0}(w) = X_{(W_I w_0, W_I w_0)}(\mathbf{w}_1 \mathbf{w}_2)$ which can be done using GAP. We deduce

$$H_c^*(X_{W_I w_0}, \overline{\mathbb{Q}}_\ell)^{U_I} \simeq H_c^*((\mathbb{G}_m)^2 \times X_{\mathbf{L}_I}(t_2 t_3 t_2 t_3), \overline{\mathbb{Q}}_\ell).$$

Note that the variety $X_{W_I w_0 t_1 t_2} \cup X_{W_I w_0 t_4 t_3}$ is closed in $X(w)$. Furthermore, the elements in $W_I w_0 t_1 t_2$ and $W_I w_0 t_4 t_3$ are not comparable in the Bruhat order and therefore both $X_{W_I w_0 t_1 t_2}$ and $X_{W_I w_0 t_4 t_3}$ are closed subvarieties of the union. In particular

$$H_c^*(X_{W_I w_0 t_1 t_2} \cup X_{W_I w_0 t_4 t_3}, \overline{\mathbb{Q}}_\ell)^{U_I} \simeq \left(H_c^*(\mathbb{G}_a \times (\mathbb{G}_m)^2 \times X_{\mathbf{L}_I}(t_3 t_2), \overline{\mathbb{Q}}_\ell) \right)^{\oplus 2}.$$

The Weyl group of \mathbf{L}_I has type B_2 . Let us denote by ε the sign representation of W_I , by θ the one-dimensional representation such that $\theta(t_2) = 1$ and $\theta(t_3) = -1$ and by r the reflection representation. Then the unipotent characters of L_I are $\{\text{Id}, \text{St}, \rho_\theta, \rho_{\theta\varepsilon}, \rho_r, \theta_{10}\}$ where θ_{10} is the unique unipotent cuspidal character. Using [11, Theorem 4.3.4] we obtain

$$\begin{aligned} H_{U_I \backslash X_{W_I w_0}} &= (h^2 t + h)^2 (h^4 \text{St} + h^5 t^2 (\rho_\theta + \rho_{\theta\varepsilon} + 2\theta_{10}) + h^8 t^4 \text{Id}) \\ &= h^6 \text{St} + h^7 (2t \text{St} + t^2 (\rho_\theta + \rho_{\theta\varepsilon} + 2\theta_{10})) + h^8 (t^2 \text{St} + 2t^3 (\rho_\theta + \rho_{\theta\varepsilon} + 2\theta_{10})) \\ &\quad + h^9 t^4 (\rho_\theta + \rho_{\theta\varepsilon} + 2\theta_{10}) + h^{10} t^4 \text{Id} + 2h^{11} t^5 \text{Id} + h^{12} t^6 \text{Id} \end{aligned}$$

and also

$$\begin{aligned} H_{U_I \backslash X_{W_I w_0 t_1 t_2}} &= h^2 t (h^2 t + h)^2 (h^2 (\text{St} + t\theta_{10}) + h^3 t \rho_r + h^4 t^2 \text{Id}) \\ &= h^6 (t \text{St} + t^2 \theta_{10}) + h^7 (t^2 (2\text{St} + \rho_r) + 2t^3 \theta_{10}) \\ &\quad + h^8 (t^3 (\text{St} + 2\rho_r + \text{Id}) + t^4 \theta_{10}) + h^9 t^4 (\rho_r + 2\text{Id}) + h^{10} t^5 \text{Id}. \end{aligned}$$

We observe that the unipotent characters ρ_θ , $\rho_{\theta\varepsilon}$ and ρ_r appear in the cohomology of only one of the two varieties. Using the long exact sequence associated to the decomposition $U_I \backslash X(w) = U_I \backslash X_{W_I w_0} \cup (U_I \backslash X_{W_I w_0 t_1 t_2} \cup U_I \backslash X_{W_I w_0 t_4 t_3})$

we deduce the isotypic part of these characters in the cohomology of $U_I \backslash X(w)$. It is given by

$$h^7 t^2(\rho_\theta + \rho_{\theta_\varepsilon} + 2\rho_r) + h^8 t^3(2\rho_\theta + 2\rho_{\theta_\varepsilon} + 4\rho_r) + h^9 t^4(\rho_\theta + \rho_{\theta_\varepsilon} + 2\rho_r). \quad (2.1)$$

The isotypic parts for the unipotent characters St and Id fit into the following exact sequences:

$$\begin{aligned} 0 \longrightarrow \text{St} \longrightarrow \mathrm{H}_c^6(U_I \backslash X(w))_{\text{St}} \longrightarrow 2t\text{St} \longrightarrow 2t\text{St} \longrightarrow \mathrm{H}_c^7(U_I \backslash X(w))_{\text{St}} \\ \longrightarrow 4t^2\text{St} \longrightarrow t^2\text{St} \longrightarrow \mathrm{H}_c^8(U_I \backslash X(w))_{\text{St}} \longrightarrow 2t^3\text{St} \longrightarrow 0 \end{aligned}$$

$$0 \longrightarrow \mathrm{H}_c^8(U_I \backslash X(w))_{\text{Id}} \longrightarrow 2t^3\text{Id} \longrightarrow 0$$

$$\begin{aligned} 0 \longrightarrow \mathrm{H}_c^9(U_I \backslash X(w))_{\text{Id}} \longrightarrow 4t^4\text{Id} \longrightarrow t^4\text{Id} \longrightarrow \mathrm{H}_c^{10}(U_I \backslash X(w))_{\text{Id}} \\ \longrightarrow 2t^5\text{Id} \longrightarrow 2t^5\text{Id} \longrightarrow \mathrm{H}_c^{11}(U_I \backslash X(w))_{\text{Id}} \longrightarrow 0 \end{aligned}$$

$$0 \longrightarrow t^6\text{Id} \longrightarrow \mathrm{H}_c^{12}(U_I \backslash X(w))_{\text{Id}} \longrightarrow 0$$

Any morphism above is F -equivariant so that we can consider each power of t separately. On the other hand, the only unipotent character of G whose restriction is St_{L_I} (resp. Id_{L_I}) is St_G (resp. Id_G). But from [11, Proposition 3.3.14 and 3.3.15] we know exactly where these characters can appear in the cohomology of $X(w)$ as well as the corresponding eigenvalue of F . Using 2.1 we deduce that $t\text{St}$ (resp. $t^2\text{St}$) cannot appear in $\mathrm{H}_c^6(U_I \backslash X(w))$ or in $\mathrm{H}_c^7(U_I \backslash X(w))$ (resp. in $\mathrm{H}_c^8(U_I \backslash X(w))$) and that $t^4\text{Id}$ (resp. $t^5\text{Id}$) cannot appear in $\mathrm{H}_c^{10}(U_I \backslash X(w))$ (resp. in $\mathrm{H}_c^{11}(U_I \backslash X(w))$). With the previous exact sequences, this forces the isotypic part of St and Id in the cohomology of $U_I \backslash X(w)$ to be

$$h^6\text{St} + 3h^7 t^2\text{St} + h^8 t^3(2\text{St} + 2\text{Id}) + 3h^9 t^4\text{Id} + h^{12} t^6\text{Id}.$$

Together with 2.1 we finally obtain

Proposition 2.2. *Let $w = t_1 t_2 t_3 t_2 t_3 t_4$ and $I = \{t_2, t_3\}$. The characters of the principal series in the cohomology of $U_I \backslash X(w)$ are given by*

$$\begin{aligned} h^6\text{St} + h^7 t^2(3\text{St} + \rho_\theta + \rho_{\theta_\varepsilon} + 2\rho_r) + h^8 t^3(2\text{St} + 2\rho_\theta + 2\rho_{\theta_\varepsilon} + 4\rho_r + 2\text{Id}) \\ + h^9 t^4(\rho_\theta + \rho_{\theta_\varepsilon} + 2\rho_r + 3\text{Id}) + h^{12} t^6\text{Id}. \end{aligned}$$

Remark 2.3. The long exact sequence coming from the decomposition of the variety $U_I \backslash X(w)$ does not give enough information to determine the θ_{10} -isotypic part:

$$\begin{aligned} 0 \longrightarrow \mathrm{H}_c^6(U_I \backslash X(w))_{\theta_{10}} \longrightarrow 2t^2\theta_{10} \longrightarrow 2t^2\theta_{10} \longrightarrow \mathrm{H}_c^7(U_I \backslash X(w))_{\theta_{10}} \longrightarrow 4t^3\theta_{10} \\ \longrightarrow 4t^3\theta_{10} \longrightarrow \mathrm{H}_c^8(U_I \backslash X(w))_{\theta_{10}} \longrightarrow 2t^4\theta_{10} \longrightarrow 2t^4\theta_{10} \longrightarrow \mathrm{H}_c^9(U_I \backslash X(w))_{\theta_{10}} \longrightarrow 0. \end{aligned}$$

One could nonetheless hope that in this particular situation the boundary maps are isomorphisms, which would imply that θ_{10} cannot appear in the cohomology of $U_I \backslash X(w)$. This will be the case if and only if the graded endomorphism ring $\text{End}_G(\mathrm{H}_c^*(X(w), \overline{\mathbb{Q}}_\ell))$ is concentrated in degree 0.

2.1.2. Cuspidal characters. From [2] we know that the irreducible constituents of the alternating sum of the comology of $X(w)$ are the unipotent characters in the principal Φ_8 -block, namely $\{\text{Id}_G, \text{St}_G, \phi_{9,10}, \phi_{16,5}, \phi_{9,2}\}$ for the principal series and $\{\text{F}_4[-1], \text{F}_4[i], \text{F}_4[-i]\}$ for the cuspidal characters (with the notation in [5]). We observe that the restriction of these characters to L_I are exactly the one obtained in the previous proposition. Since the Harish-Chandra restriction preserves the Harish-Chandra series, we can deduce the contribution of the principal series to the cohomology of $X(w)$. The missing ones are either in the series associated to θ_{10} – which we could not determine – or are cuspidal characters. We shall deduce the contribution of the latter using the results in Section 1.2.

Recall that G has 7 cuspidal unipotent characters, namely $\text{F}_4[-1], \text{F}_4[i], \text{F}_4[-i], \text{F}_4[\theta], \text{F}_4[\theta^2], \text{F}_4^I[1]$ and $\text{F}_4^{II}[1]$ where i (resp. θ) is a primitive 4th root of unity (resp. a primitive 3rd root of unity). Let ρ be a cuspidal unipotent character and let $v \leq w$. By cuspidality ρ cannot appear in the cohomology of Deligne-Lusztig varieties associated to elements lying in a proper parabolic subgroup of W . In particular it cannot appear in the cohomology of $X(v)$ or $X(\underline{v})$ unless v is in the following set

$$\mathcal{V} = \{w, t_1 t_2 t_3 t_2 t_4, t_1 t_3 t_2 t_3 t_4, t_1 t_2 t_3 t_4, t_1 t_3 t_2 t_4\}.$$

Define $Z = X(\underline{t_1 t_2 t_3 t_2 t_4}) \cup X(\underline{t_1 t_3 t_2 t_3 t_4})$ and $Z' = X(\underline{t_1 t_2 t_3 t_4}) \cup X(\underline{t_1 t_3 t_2 t_4})$. The property (C2) yields the following exact sequences:

$$\cdots \longrightarrow H_c^i(X(w))_\rho \longrightarrow H_c^i(X(\underline{w}))_\rho \longrightarrow H_c^i(Z)_\rho \longrightarrow \cdots \quad (2.4)$$

$$\cdots \longrightarrow H_c^i(X(\underline{t_1 t_2 t_3 t_2 t_4}))_\rho \longrightarrow H_c^i(X(\underline{t_1 t_2 t_3 t_2 t_4}))_\rho \longrightarrow H_c^i(Z')_\rho \longrightarrow \cdots \quad (2.5)$$

$$\cdots \longrightarrow H_c^i(X(\underline{t_1 t_3 t_2 t_3 t_4}))_\rho \longrightarrow H_c^i(X(\underline{t_1 t_3 t_2 t_3 t_4}))_\rho \longrightarrow H_c^i(Z')_\rho \longrightarrow \cdots \quad (2.6)$$

Moreover, one can check that each of these compactifications is actually rationally smooth, and therefore one can use (C3) to compute the cuspidal part of their cohomology, denoted by $\underline{H}_X(t^{1/2}, h)$. They are given by

$$\underline{H}_{X(w)} = h^6 t^3 (\text{F}_4[-1] + \text{F}_4[i] + \text{F}_4[-i] + 2\text{F}_4[\theta] + 2\text{F}_4[\theta^2]) \quad (2.7)$$

and $\underline{H}_{X(\underline{t_1 t_2 t_3 t_2 t_4})} = \underline{H}_{X(\underline{t_1 t_3 t_2 t_3 t_4})} = (h^4 t^2 + h^6 t^3)(\text{F}_4[i] + \text{F}_4[-i] + \text{F}_4[\theta] + \text{F}_4[\theta^2])$.

Furthermore, the elements $t_1 t_2 t_3 t_4$ and $t_1 t_3 t_2 t_4$ are minimal in the set \mathcal{V} for the Bruhat order, so that for any unipotent cuspidal character ρ

$$H_c^i(Z')_\rho \simeq H_c^i(X(\underline{t_1 t_2 t_3 t_4}))_\rho \oplus H_c^i(X(\underline{t_1 t_3 t_2 t_4}))_\rho \simeq H_c^i(X(c))_\rho^{\oplus 2}$$

where c is any Coxeter element of W . Using [20, table 7.3] we deduce that

$$\underline{H}_{Z'} = 2h^4 t^2 (\text{F}_4[i] + \text{F}_4[-i] + \text{F}_4[\theta] + \text{F}_4[\theta^2]).$$

Together with 2.5 and 2.6, and the fact that the cohomology of $X(\underline{t_1 t_2 t_3 t_2 t_4})$ and $X(\underline{t_1 t_3 t_2 t_3 t_4})$ vanishes in degree 4, we obtain

$$\underline{H}_{X(\underline{t_1 t_2 t_3 t_2 t_4})} = \underline{H}_{X(\underline{t_1 t_3 t_2 t_3 t_4})} = (h^5 t^2 + h^6 t^3)(\text{F}_4[i] + \text{F}_4[-i] + \text{F}_4[\theta] + \text{F}_4[\theta^2]).$$

From these results, one can now partially determine the cohomology of Z : for any unipotent cuspidal character, we use the following exact sequence

$$\cdots \longrightarrow H_c^i(X(t_1 t_2 t_3 t_2 t_4))_\rho \oplus H_c^i(X(t_1 t_3 t_2 t_3 t_4))_\rho \longrightarrow H_c^i(Z)_\rho \longrightarrow H_c^i(Z')_\rho \longrightarrow \cdots$$

to deduce that there exist integers $0 \leq \varepsilon_i \leq 2$ such that

$$\begin{aligned} \underline{H}_Z = (h^4 + h^5)t^2(\varepsilon_1 F_4[i] + \varepsilon_2 F_4[-i] + \varepsilon_3 F_4[\theta] + \varepsilon_4 F_4[\theta^2]) \\ + 2h^6 t^3(F_4[i] + F_4[-i] + F_4[\theta] + F_4[\theta^2]). \end{aligned}$$

However 2.4 forces each character $\varepsilon_i \rho$ to be a component of $H_c^5(X(w))$ since $H_c^4(X(w))$ is zero by 2.7. But the cohomology of $X(w)$ vanishes outside the degrees $6, \dots, 12$, and hence the ε_i 's must be zero. Consequently, the exact sequence 2.4 can be decomposed into

$$\begin{aligned} 0 \longrightarrow H_c^6(X(w))_{F_4[-1]} \longrightarrow t^3 F_4[-1] \longrightarrow 0 \\ 0 \longrightarrow H_c^6(X(w))_{F_4[\pm i]} \longrightarrow t^3 F_4[\pm i] \longrightarrow 2t^3 F_4[\pm i] \longrightarrow H_c^7(X(w))_{F_4[\pm i]} \longrightarrow 0 \\ 0 \longrightarrow H_c^6(X(w))_{F_4[\theta^j]} \longrightarrow 2t^3 F_4[\theta^j] \longrightarrow 2t^3 F_4[\theta^j] \longrightarrow H_c^7(X(w))_{F_4[\theta^j]} \longrightarrow 0. \end{aligned}$$

We use (C4) to conclude: the characters $F_4[\pm i]$, and $F_4[\theta^j]$ already occur in the cohomology of the Deligne-Lusztig variety associated to a Coxeter element. Since w is not F -conjugate to a Coxeter element, they cannot appear in $H_c^6(X(w))$ with an eigenvalue of absolute value q^3 , and the previous exact sequences determine the cuspidal part of the cohomology of $X(w)$.

Proposition 2.8. *Let $w = t_1 t_2 t_3 t_2 t_4$. The cuspidal part of the cohomology of $X(w)$ is given by*

$$h^6 t^3 F_4[-1] + h^7 t^3 (F_4[i] + F_4[-i]).$$

2.1.3. Cohomology of $X(w)$. The unipotent characters in the principal Φ_8 -block b are given by $b_{\text{uni}} = \{\text{Id}, \text{St}_G, \phi_{9,10}, \phi_{16,5}, \phi_{9,2}, F_4[-1], F_4[i], F_4[-i]\}$. From Proposition 2.2 and 2.8 we deduce the contribution to the cohomology of $X(w)$ of any unipotent character in the block:

Theorem 2.9. *Let (G, F) be a split group of type F_4 and w be a good 8-regular element. The contribution to the cohomology of the Deligne-Lusztig $X(w)$ of the principal series and the cuspidal characters coincides with the contribution of the principal Φ_8 -block, and it is given by*

i	6	7	8	9	10	11	12
$bH^i(X(w), \overline{\mathbb{Q}}_\ell)$	St $-q^3 F_4[-1]$	$q^2 \phi_{9,10}$ $i q^3 F_4[i]$ $-i q^3 F_4[-i]$	$q^3 \phi_{16,5}$	$q^4 \phi_{9,2}$			$q^6 \text{Id}$

2.2 9-regular elements for groups of type E_6

In this section we assume that (\mathbf{G}, F) is a split group of type E_6 . The largest regular number (excluding the Coxeter number) being 9, we are interested in computing the cohomology of $X(w)$ for any 9th root of π , or equivalently for any good 9-regular element. We will label the simple reflections as follows

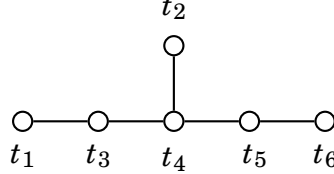

As before, we may, and we will, consider a particular root of π , since the cohomology of the corresponding Deligne-Lusztig variety $X(w)$ does not depend on this choice. We set

$$w = t_1 t_3 t_4 t_3 t_2 t_4 t_5 t_6.$$

2.2.1. Cohomology of $U_I \backslash X(w)$. We decompose the quotient of $X(w)$ by U_I for $I = \{t_2, t_3, t_4, t_5\}$. The situation is similar to the one studied in Section 2.1.1: a piece X_x is non-empty if and only if $W_I x$ is one of the three cosets among $W_I w_0$, $W_I w_0 t_6 t_5 t_4$ and $W_I w_0 t_1 t_3$.

- Let $J = S \setminus \{t_1\}$. We have $W_J w_0 t_1 t_3 = W_J w_0$ and therefore the piece corresponding to $W_I w_0 t_6 t_5 t_4$ is stable by the action of P_J . Let y be the minimal element of $W_J w_0 t_6 t_5 t_4$. Since $w_0(t_6 t_5 t_4) = t_1 t_3 t_4$ is J -reduced, $y = w_J w_0 t_6 t_5 t_4$. Let us decompose w as $w = w_1 w_2 w_3$ with $w_1 = t_1$, $w_2 = t_3 = t_3 w'_2$ and $w_3 = t_4 t_3 t_2 t_4 t_5 t_6$. Then ${}^y w_1 = t_6$, ${}^y w'_2 = 1$ and ${}^y w_3 = t_3 t_5 t_4 t_2$ are all elements of W_J . In addition, they satisfy the assumptions of Theorem 1.1 (see also Remark 1.2) so that

$$H_c^*(X_{W_J y}, \overline{\mathbb{Q}}_\ell)^{U_J} \simeq H_c^*(\mathbb{G}_a \times \mathbb{G}_m \times X_{\mathbf{L}_J}(t_6 t_3 t_5 t_4 t_2), \overline{\mathbb{Q}}_\ell).$$

Now $X_{\mathbf{L}_J}(t_6 t_3 t_5 t_4 t_2)$ is a Deligne-Lusztig variety associated to a Coxeter element, and therefore the cohomology of its quotient by $U_I \cap \mathbf{L}_J$ is given by [20]. We obtain

$$\begin{aligned} H_c^*(X_{W_I w_0 t_6 t_5 t_4}, \overline{\mathbb{Q}}_\ell)^{U_I} &\simeq (H_c^*(\mathbb{G}_a \times \mathbb{G}_m \times X_{\mathbf{L}_J}(t_6 t_3 t_5 t_4 t_2), \overline{\mathbb{Q}}_\ell))^{U_I \cap \mathbf{L}_J} \\ &\simeq H_c^*(\mathbb{G}_a \times (\mathbb{G}_m)^2 \times X_{\mathbf{L}_I}(t_2 t_5 t_4 t_3), \overline{\mathbb{Q}}_\ell). \end{aligned}$$

- For the piece $X_{W_I w_0 t_1 t_3}$, we proceed as above: let $K = S \setminus \{t_6\}$ and z be the minimal element of $W_K w_0 t_1 t_3$. It is clearly $z = w_K w_0 t_1 t_3$ since $t_6 t_5$ is K -reduced. We can decompose w as $w = w_1 w_2$ where $w_1 = t_1 t_3 t_4 t_3 t_2$ and $w_2 = t_4(t_5 t_6) = t_4 w'_2$. We have ${}^z w_1 = t_2 t_4 t_5$ and ${}^z w'_2 = t_3 t_1$ so that with Theorem 1.1 and [20] we obtain

$$\begin{aligned} H_c^*(X_{W_I w_0 t_1 t_3}, \overline{\mathbb{Q}}_\ell)^{U_I} &\simeq (H_c^*(\mathbb{G}_a \times \mathbb{G}_m \times X_{\mathbf{L}_K}(t_2 t_4 t_5 t_3 t_1), \overline{\mathbb{Q}}_\ell))^{U_I \cap \mathbf{L}_K} \\ &\simeq H_c^*(\mathbb{G}_a \times (\mathbb{G}_m)^2 \times X_{\mathbf{L}_I}(t_5 t_4 t_2 t_3), \overline{\mathbb{Q}}_\ell). \end{aligned}$$

- For the open piece $X_{W_I w_0}$ we can directly apply Theorem 1.1 by decomposing w as $w = w_1 w_2$ with $w_1 = t_1(t_3 t_4 t_3 t_2 t_4 t_5)$ and $w_2 = t_6$. We deduce

$$H_c^*(X_{W_I w_0}, \overline{\mathbb{Q}}_\ell)^{U_I} \simeq H_c^*((\mathbb{G}_m)^2 \times X_{L_I}(t_5 t_4 t_5 t_2 t_4 t_3), \overline{\mathbb{Q}}_\ell).$$

By the properties of the Bruhat order the varieties $X_{W_I w_0 t_6 t_5 t_4}$ and $X_{W_I w_0 t_1 t_3}$ are both closed subvarieties of $X(w)$. Therefore the cohomology of the union $X_f = U_I \backslash X_{W_I w_0 t_6 t_5 t_4} \cup U_I \backslash X_{W_I w_0 t_1 t_3}$ can be deduced from [20, Table 7.3] whereas the cohomology of $X_o = U_I \backslash X_{W_I w_0}$ is given by [9, Theorem 12.4]:

$$H_{X_o} = (h^2 t + h)^2 (h^6 \text{St} + h^7 (t^2 (\rho_{1^2+} + \rho_{1^2-} + \rho_{21^2}) + 2t^3 D_4) + 2h^8 t^3 \rho_{1.21} + h^9 t^4 (\rho_{2+} + \rho_{2-} + \rho_{31}) + h^{12} t^6 \text{Id})$$

$$H_{X_f} = 2h^2 t (h^2 t + h)^2 (h^4 (\text{St} + t^2 D_4) + h^5 t \rho_{1.1^3} + h^6 t^2 \rho_{1^2.2} + h^7 t^3 \rho_{1.3} + h^8 t^4 \text{Id})$$

where ρ_λ is the unipotent character (in the principal series) associated to the character λ of W_I and D_4 is the unique unipotent cuspidal character of L_I .

As before, any character in the principal series which is different from St and Id cannot appear in the cohomology of both of the varieties, so that the isotypic part on the cohomology of $U_I \backslash X(w)$ is the sum of the isotypic part on $H_c^*(X_f)$ and $H_c^*(X_o)$. For the characters St and Id , we proceed exactly as in Section 2.1.1 using [11, Proposition 3.3.14] and [11, Proposition 3.3.15].

Proposition 2.10. *Let $w = t_1 t_3 t_4 t_3 t_2 t_4 t_5 t_6$ and $I = \{t_2, t_3, t_4, t_5\}$. The contribution of the characters in the principal series to the cohomology of $U_I \backslash X(w)$ is given by*

$$\begin{aligned} & h^8 \text{St} + h^9 t^2 (3\text{St} + \rho_{1^2+} + \rho_{1^2-} + \rho_{21^2} + 2\rho_{1.1^3}) \\ & + h^{10} t^3 (2\text{St} + 2\rho_{1^2+} + 2\rho_{1^2-} + 2\rho_{21^2} + 4\rho_{1.1^3} + 2\rho_{1.21} + 2\rho_{1^2.2}) \\ & + h^{11} t^4 (\rho_{1^2+} + \rho_{1^2-} + \rho_{21^2} + 2\rho_{1.1^3} + 4\rho_{1.21} + 4\rho_{1^2.2} + \rho_{2+} + \rho_{2-} + \rho_{31} + 2\rho_{1.3}) \\ & + h^{12} t^5 (2\rho_{1.21} + 2\rho_{1^2.2} + 2\rho_{2+} + 2\rho_{2-} + 2\rho_{31} + 4\rho_{1.3} + 2\text{Id}) \\ & + h^{13} t^6 (\rho_{2+} + \rho_{2-} + \rho_{31} + 2\rho_{1.3} + 3\text{Id}) + h^{16} t^8 \text{Id}. \end{aligned}$$

Remark 2.11. Unfortunately, this method is not sufficient for determining the D_4 -isotypic part (see also Remark 2.3).

2.2.2. Cuspidal characters. The group G has only two cuspidal characters, denoted by $E_6[\theta]$ and $E_6[\theta^2]$ where θ is a primitive 3rd root of unity. In order to determine they contribution to the cohomology of $X(w)$, we use the compactifications $X(\underline{v})$ for $v \leq w$. However, unlike the type F_4 , they are not always rationally smooth and we shall rather work with "bigger" compactifications, obtained by underlining all the simple reflections. For details on the explicit computations we refer to Section 2.1.2. We start by defining the following closed subvariety of $\overline{X}(w)$:

$$Z = X(\underline{t_1 t_4 t_3 t_2 t_4 t_5 t_6}) \cup X(\underline{t_1 t_3 t_3 t_2 t_4 t_5 t_6}) \cup X(\underline{t_1 t_3 t_4 t_2 t_4 t_5 t_6}) \cup X(\underline{t_1 t_3 t_4 t_3 t_2 t_5 t_6})$$

so that we obtain, for any cuspidal character ρ , a long exact sequence

$$\cdots \longrightarrow H_c^i(X(w))_\rho \longrightarrow H_c^i(\overline{X}(w))_\rho \longrightarrow H_c^i(Z)_\rho \longrightarrow \cdots \quad (2.12)$$

We determine the cuspidal part of Z as follows: we compute, for any element $v \in \{t_1 t_4 t_3 t_2 t_4 t_5 t_6, t_1 t_3 t_4 t_2 t_4 t_5 t_6, t_1 t_3 t_4 t_3 t_2 t_5 t_6\}$

$$\underline{H}_{X(\mathbf{v})} = \underline{H}_{X(v)} = (h^7 t^3 + h^8 t^4)(\mathbf{E}_6[\theta] + \mathbf{E}_6[\theta^2])$$

by means of the following exact sequences

$$\cdots \longrightarrow H_c^i(X(v))_\rho \longrightarrow H_c^i(\overline{X}(v))_\rho \longrightarrow (H_c^i(\overline{X}(c))_\rho)^{\oplus 2} \longrightarrow \cdots$$

and the precise values

$$\underline{H}_{\overline{X}(v)} = (h^6 t^3 + h^8 t^4)(\mathbf{E}_6[\theta] + \mathbf{E}_6[\theta^2])$$

and

$$\underline{H}_{\overline{X}(c)} = h^6 t^3 (\mathbf{E}_6[\theta] + \mathbf{E}_6[\theta^2])$$

that can be found using **(C3)**. Note that we have also used the fact that the cohomology of $X(v)$ is zero outside the degrees $7, \dots, 14$. For the element $\mathbf{v} = t_1 t_3 t_3 t_2 t_4 t_5 t_6$ we use [11, Proposition 3.2.10] and we obtain the same value again:

$$\underline{H}_{X(\mathbf{v})} = (h^2 t + h) \underline{H}_{\overline{X}(c)} = (h^7 t^3 + h^8 t^4)(\mathbf{E}_6[\theta] + \mathbf{E}_6[\theta^2])$$

In particular, the cohomology of Z fits into the following long exact sequence

$$\cdots \longrightarrow (H_c^i(X(\mathbf{v}))_\rho)^{\oplus 4} \longrightarrow H_c^i(Z)_\rho \longrightarrow (H_c^i(\overline{X}(c))_\rho)^{\oplus 4} \longrightarrow \cdots$$

We claim that

$$\underline{H}_Z = 4h^8 t^4 (\mathbf{E}_6[\theta] + \mathbf{E}_6[\theta^2]). \quad (2.13)$$

Again, the exact sequence itself is not enough to compute this value, but it can be deduced from the following properties:

- the cohomology of $X(w)$ vanishes in degree 7 by **(C1)**;
- $\underline{H}_{\overline{X}(w)} = 3h^8 t^4 (\mathbf{E}_6[\theta] + \mathbf{E}_6[\theta^2])$ which forces in particular $H_c^6(\overline{X}(w))$ to have no cuspidal constituent.

These properties, together with 2.12, ensure that the coefficient of h^6 in \underline{H}_Z is zero, and we deduce 2.13.

Consequently, the decomposition $\overline{X}(w) = X(w) \cup Z$ yields the following exact sequence for any cuspidal character ρ :

$$0 \longrightarrow H_c^8(X(w))_\rho \longrightarrow 3t^4 \rho \longrightarrow 4t^4 \rho \longrightarrow H_c^9(X(w))_\rho \longrightarrow 0.$$

Finally, by **(C4)** the group $H_c^8(X(w))$ cannot contain any unipotent cuspidal character with an eigenvalue of absolute value q^4 and we obtain:

Proposition 2.14. *Let $w = t_1 t_3 t_4 t_3 t_2 t_4 t_5 t_6$. The contribution of the cuspidal characters of G to the cohomology of $X(w)$ is given by*

$$h^9 t^4 (\mathbf{E}_6[\theta] + \mathbf{E}_6[\theta^2]).$$

2.2.3. Cohomology of $X(w)$. By [4], the irreducible constituents of the virtual character associated to the cohomology of $X(w)$ are exactly the unipotent characters in the principal Φ_9 -block, namely $b_{\text{uni}} = \{\text{Id}_G, \text{St}_G, \phi_{20,20}, \phi_{64,13}, \phi_{90,8}, \phi_{64,4}, \phi_{20,2}, E_6[\theta], E_6[\theta^2]\}$. By looking at the Harish-Chandra restriction of these characters, we can deduce from Proposition 2.10 and 2.14 the following theorem:

Theorem 2.15. *Let (G, F) be a split group of type E_6 and w be a good 9-regular element of W . The contribution to the cohomology of the Deligne-Lusztig $X(w)$ of the principal series and the cuspidal characters coincides with the contribution of the principal Φ_9 -block, and it is given by*

i	8	9	10	11	12	13	14	15	16
$bH^i(X(w), \overline{\mathbb{Q}}_\ell)$	St	$q^2\phi_{20,20}$ $\theta q^4 E_6[\theta]$ $\theta^2 q^4 E_6[\theta^2]$	$q^3\phi_{64,13}$	$q^4\phi_{90,8}$	$q^5\phi_{64,4}$	$q^6\phi_{20,2}$			$q^8\text{Id}$

Conjecturally, for good regular elements, there should be no cancelation in the virtual character $\sum (-1)^i H_c^i(X(w), \overline{\mathbb{Q}}_\ell) \in K_0(G\text{-mod})$ [3, Conjecture 5.7]. In particular, the series associated to the cuspidal character of D_4 should not appear in the cohomology of $X(w)$:

Assumption 2.16. For good 9-regular elements in E_6 , the cohomology of $X(w)$ has no constituent in the Harish-Chandra series associated to the cuspidal representation of D_4 .

This assumption will be essential to study the contribution of the D_4 -series for groups of type E_7 and E_8 (see Theorem 2.20 and 2.26).

2.3 14-regular elements for groups of type E_7

We now assume that (G, F) is a split group of type E_7 and we are interested in computing the cohomology of Deligne-Lusztig varieties associated to good 14-regular elements. We will label the simple reflections according to the following Dynkin diagram

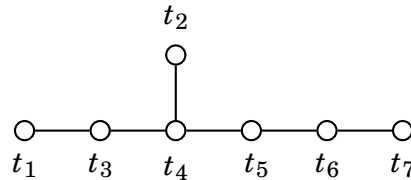

and consider a specific 9th root of π :

$$w = t_7 t_6 t_5 t_4 t_5 t_2 t_4 t_3 t_1.$$

2.3.1. Cohomology of $U_I \backslash X(w)$. Let $I = S \setminus \{t_7\}$. The group L_I has type E_6 and we can use the results in the previous section to compute the cohomology of the

quotient of $X(w)$ by U_I . In the decomposition of $X(w)$ by \mathbf{P}_I -cosets in \mathbf{G}/\mathbf{B} , only two pieces are non-empty, with associated cosets $W_I w_0$ and $W_I w_0 t_7 t_6 t_5$. We can apply Theorem 1.1 in these two cases:

- when $y = w_I w_0 t_7 t_6 t_5$ we decompose w as $w = w_1 w_2$ with $w_1 = t_7 t_6 t_5 t_4 t_5 t_2$ and $w_2 = t_4 (t_3 t_1) = t_4 w'_2$. We have ${}^y w_1 = t_1 t_3 t_4 t_2$ and ${}^y w'_2 = t_5 t_6$ so that

$$H_c^*(X_{W_I y}, \overline{\mathbb{Q}}_\ell)^{U_I} \simeq H_c^*(\mathbb{G}_a \times \mathbb{G}_m \times X_{L_I}(t_1 t_3 t_4 t_2 t_5 t_6), \overline{\mathbb{Q}}_\ell).$$

- for $x = w_I w_0$ we observe that $w = t_7 (t_6 t_5 t_4 t_5 t_2 t_4 t_3 t_1) = t_7 w'$ with ${}^x w' \in W_J$ and deduce that

$$H_c^*(X_{W_I w_0}, \overline{\mathbb{Q}}_\ell)^{U_I} \simeq H_c^*(\mathbb{G}_m \times X_{L_I}(t_1 t_3 t_4 t_3 t_2 t_4 t_5 t_6), \overline{\mathbb{Q}}_\ell).$$

The cohomology of these varieties is known by Theorem 2.15 and [20, Table 7.3]. Recall that for any Coxeter element c_I of W_I , the cohomology of the corresponding variety is given by

$$\begin{aligned} H_{X_{L_I}(c_I)} &= h^6(\text{St} + t^2 D_{4,\varepsilon} + t^3 E_6[\theta] + t^3 E_6[\theta^2]) + h^7(t\phi_{6,25} + t^3 D_{4,r}) \\ &\quad + h^8(t^2\phi_{15,17} + t^4 D_{4,\text{Id}}) + h^9 t^3 \phi_{20,10} + h^{10} t^4 \phi_{15,5} + h^{11} t^5 \phi_{6,1} + h^{12} t^6 \text{Id}. \end{aligned}$$

If we exclude St and Id, none of the characters in the principal series that appear here can appear in the cohomology of $U_I \backslash X_{W_I w_0}$. From that observation one can readily deduce the contribution of the principal series to the cohomology of $U_I \backslash X(w)$. Note that in the case of St and Id we can proceed as in Section 2.1.1.

Proposition 2.17. *Let $w = t_7 t_6 t_5 t_4 t_5 t_2 t_4 t_3 t_1$ and $I = \Delta \setminus \{t_7\}$. The contribution of the principal series to the cohomology of $U_I \backslash X(w)$ is given by*

$$\begin{aligned} &h^9 \text{St} + h^{10} t^2 (\text{St} + \phi_{6,25} + \phi_{20,20}) + h^{11} t^3 (\phi_{6,25} + \phi_{20,20} + \phi_{15,17} + \phi_{64,13}) \\ &+ h^{12} t^4 (\phi_{15,17} + \phi_{64,13} + \phi_{20,10} + \phi_{90,8}) + h^{13} t^5 (\phi_{20,10} + \phi_{90,8} + \phi_{15,5} + \phi_{64,4}) \\ &+ h^{14} t^6 (\phi_{15,5} + \phi_{64,4} + \phi_{6,1} + \phi_{20,2}) + h^{15} t^7 (\phi_{6,1} + \phi_{20,2} + \text{Id}) + h^{18} t^9 \text{Id}. \end{aligned}$$

The case of the Harish-Chandra series associated to the cuspidal character of D_4 remains undetermined unless we know the contribution of this series to the cohomology of the open part. However, in our situation, none of these characters should appear, and the isotypic part on the cohomology of the union $U_I \backslash X(w)$ should come from the Coxeter variety only.

Proposition 2.18. *Assume that 2.16 holds, and let $w = t_7 t_6 t_5 t_4 t_5 t_2 t_4 t_3 t_1$ and $I = \Delta \setminus \{t_7\}$. Then the contribution of the Harish-Chandra series associated to the cuspidal character of D_4 to the cohomology of $U_I \backslash X(w)$ is given by*

$$h^9 t^3 D_{4,\varepsilon} + h^{10} t^4 (D_{4,\varepsilon} + D_{4,r}) + h^{11} t^5 (D_{4,r} + D_{4,\text{Id}}) + h^{12} t^6 D_{4,\text{Id}}.$$

Finally, for the cuspidal characters $E_6[\theta]$ and $E_6[\theta^2]$, we have a long exact sequence

$$\begin{aligned} 0 \longrightarrow H_c^9(U_I \backslash X(w))_{E_6[\theta]} &\longrightarrow t^4 E_6[\theta] \longrightarrow t^4 E_6[\theta] \longrightarrow H_c^{10}(U_I \backslash X(w))_{E_6[\theta]} \\ &\longrightarrow t^5 E_6[\theta] \longrightarrow t^5 E_6[\theta] \longrightarrow H_c^{11}(U_I \backslash X(w))_{E_6[\theta]} \longrightarrow 0. \end{aligned}$$

This is not enough to determine their contribution and we can only hope that they actually do not appear in the cohomology of $U_I \backslash X(w)$.

2.3.2. Cuspidal characters. The group G has only two cuspidal unipotent characters, namely $E_7[i]$ and $E_7[-i]$, where i is a primitive 4th root of unity. The method to determine their contribution to the cohomology is strictly identical to the case of E_6 and yields

Proposition 2.19. *Let $w = t_7 t_6 t_5 t_4 t_5 t_2 t_4 t_3 t_1$. The cuspidal part of the cohomology of $X(w)$ is given by*

$$h^{10} t^{9/2} (E_7[i] + E_7[-i]).$$

2.3.3. Cohomology of $X(w)$. By combining Proposition 2.17 and 2.18, we obtain the Harish-Chandra restriction to E_6 of the cohomology of the variety $X(w)$. If we compare these to the restriction of the characters in the principal Φ_{14} -block $b_{\text{uni}} = \{\text{St}_G, \text{Id}_G, \phi_{27,37}, \phi_{105,26}, \phi_{189,17}, \phi_{189,10}, \phi_{105,5}, \phi_{27,2}, D_{4,1^3}, D_{4,1^2,1}, D_{4,1,2}, D_{4,3}, E_7[i], E_7[-i]\}$ (and the fact that these actually occur as constituents of the cohomology) we deduce their exact contribution. Adding the cuspidal characters obtained in 2.19, we get

Theorem 2.20. *Let (G, F) be a split group of type E_7 and w be a good 14-regular element of W . The contribution to the cohomology of the Deligne-Lusztig $X(w)$ of the principal series, the D_4 -series and the cuspidal characters coincides with the contribution of the principal Φ_{14} -block, and it is given by*

i	9	10	11	12	13
$bH^i(X(w), \overline{\mathbb{Q}}_\ell)$	St $-q^3 D_{4,1^3}$	$q^2 \phi_{27,37}$ $-q^4 D_{4,1^2,1}$ $i q^{9/2} E_7[i]$ $-i q^{9/2} E_7[-i]$	$q^3 \phi_{105,26}$ $-q^5 D_{4,1,2}$	$q^4 \phi_{189,17}$ $-q^6 D_{4,3}$	$q^5 \phi_{189,10}$

i	14	15	16	17	18
$bH^i(X(w), \overline{\mathbb{Q}}_\ell)$	$q^6 \phi_{105,5}$	$q^7 \phi_{27,2}$			$q^9 \text{Id}$

where the D_4 -series is given under Assumption 2.16.

In our situation, the non-cancellation for the corresponding Deligne-Lusztig virtual character is equivalent to the following:

Assumption 2.21. The characters lying in the Harish-Chandra series associated to the cuspidal characters $E_6[\theta]$ and $E_6[\theta^2]$ do not appear in the cohomology of $X(w)$.

2.4 24-regular elements for groups of type E_8

We close this section by studying the cohomology of Deligne-Lusztig varieties associated to good 24-regular elements in E_8 . We will label the simple reflections as follows

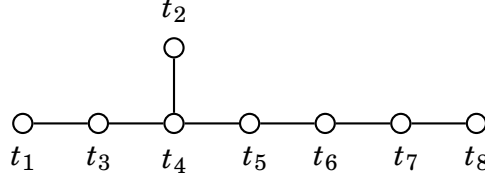

and choose the following 24th root of π :

$$w = t_8 t_7 t_6 t_5 t_4 t_5 t_2 t_4 t_3 t_1.$$

2.4.1. Cohomology of $U_I \backslash X(w)$. The situation is very similar to the case of E_7 so we will omit the details. When $I = S \setminus \{t_8\}$, the pieces corresponding to $W_I w_0$ and $W_I w_0 t_8 t_7 t_6 t_5$ are the only non-empty pieces, and the cohomology of their quotient by U_I is given by

$$\mathbf{H}_c^*(U_I \backslash X_{W_I w_0 t_8 t_7 t_6 t_5}, \overline{\mathbb{Q}}_\ell) \simeq \mathbf{H}_c^*(\mathbb{G}_a \times \mathbb{G}_m \times X_{L_I}(t_7 t_6 t_5 t_4 t_2 t_3 t_1), \overline{\mathbb{Q}}_\ell)$$

and $\mathbf{H}_c^*(U_I \backslash X_{W_I w_0}, \overline{\mathbb{Q}}_\ell) \simeq \mathbf{H}_c^*(\mathbb{G}_m \times X_{L_I}(t_7 t_6 t_5 t_4 t_5 t_2 t_4 t_3 t_1), \overline{\mathbb{Q}}_\ell)$.

The latter has been computed in the previous section, whereas the cohomology of a Deligne-Lusztig variety associated to any Coxeter element c_I of W_I can be deduced from [20, Table 7.3]:

$$\begin{aligned} \mathbf{H}_{X_{L_I}(c_I)} = & h^7 (\text{St} + t^2 \mathbf{D}_{4,\varepsilon} + t^3 (\mathbf{E}_6[\theta]_\varepsilon + \mathbf{E}_6[\theta^2]_\varepsilon) + t^{7/2} (\mathbf{E}_7[\text{i}] + \mathbf{E}_7[-\text{i}])) \\ & + h^8 (t\phi_{7,46} + t^3 \mathbf{D}_{4,1.1^2} + t^4 (\mathbf{E}_6[\theta]_{\text{Id}} + \mathbf{E}_6[\theta^2]_{\text{Id}})) \\ & + h^9 (t^2 \phi_{21,33} + t^4 \mathbf{D}_{4,2.1}) + h^{10} (t^3 \phi_{35,22} + t^5 \mathbf{D}_{4,\text{Id}}) \\ & + h^{11} t^4 \phi_{35,13} + h^{12} t^5 \phi_{21,6} + h^{13} t^6 \phi_{7,1} + h^{14} t^7 \text{Id}. \end{aligned}$$

Together with Theorem 2.20, this is enough to determine the contribution of the principal series:

Proposition 2.22. *Let $w = t_8 t_7 t_6 t_5 t_4 t_5 t_2 t_4 t_3 t_1$ and $I = \Delta \setminus \{t_8\}$. The contribution of the principal series to the cohomology of $U_I \backslash X(w)$ is given by*

$$\begin{aligned} & h^{10} \text{St} + h^{11} t^2 (\text{St} + \phi_{7,46} + \phi_{27,37}) + h^{12} t^3 (\phi_{7,46} + \phi_{27,37} + \phi_{21,33} + \phi_{105,26}) \\ & + h^{13} t^4 (\phi_{21,33} + \phi_{105,26} + \phi_{35,22} + \phi_{189,17}) + h^{14} t^5 (\phi_{35,22} + \phi_{189,17} + \phi_{35,13} + \phi_{189,10}) \\ & + h^{15} t^6 (\phi_{35,13} + \phi_{189,10} + \phi_{21,6} + \phi_{105,5}) + h^{16} t^7 (\phi_{21,6} + \phi_{105,5} + \phi_{7,1} + \phi_{27,2}) \\ & + h^{17} t^8 (\phi_{7,1} + \phi_{27,2} + \text{Id}) + h^{20} t^{10} \text{Id}. \end{aligned}$$

The results for the intermediate series depend whether the assumptions 2.16 and 2.21 are satisfied. If they hold, we can easily obtain:

Proposition 2.23. *Let $w = t_8 t_7 t_6 t_5 t_4 t_5 t_2 t_4 t_3 t_1$ and $I = \Delta \setminus \{t_8\}$.*

- (i) Under Assumption 2.16, the contribution of the D_4 -series to the cohomology of $U_I \backslash X(w)$ is given by

$$\begin{aligned} & h^{10}t^3(D_{4,\varepsilon} + D_{4,1^3}) + h^{11}t^4(D_{4,\varepsilon} + D_{4,1^3} + D_{4,1,1^2} + D_{4,1^2,1}) \\ & + h^{12}t^5(D_{4,1,1^2} + D_{4,1^2,1} + D_{4,2,1} + D_{4,1,2}) \\ & + h^{13}t^6(D_{4,2,1} + D_{4,1,2} + D_{4,\text{Id}} + D_{4,3}) + h^{14}t^7(D_{4,\text{Id}} + D_{4,3}). \end{aligned}$$

- (ii) Under Assumption 2.21, the contribution of the E_6 -series to the cohomology of $U_I \backslash X(w)$ is given by

$$h^{10}t^4E_6[\theta]_\varepsilon + h^{11}t^5(E_6[\theta]_\varepsilon + E_6[\theta]_{\text{Id}}) + h^{12}t^6E_6[\theta]_{\text{Id}}$$

$$\text{and } h^{10}t^4E_6[\theta^2]_\varepsilon + h^{11}t^5(E_6[\theta^2]_\varepsilon + E_6[\theta^2]_{\text{Id}}) + h^{12}t^6E_6[\theta^2]_{\text{Id}}.$$

2.4.2. Cuspidal characters. The group G has several cuspidal unipotent characters, denoted in [5] by $E_8[\pm i], E_8[\pm \theta], E_8[\pm \theta^2], E_8^I[1], E_8^{II}[1]$ and $E_8[\zeta^j]$ where ζ is a primitive 5th root of unity and $j = 1, 2, 3, 4$. We proceed as in the previous cases to determine their contribution to the cohomology of $X(w)$. However, due to the large number of cuspidal characters, the calculations are a bit more tedious.

We start by considering the closed subvariety Z of $\overline{X}(w)$ consisting of the union of the varieties $X(v)$ where v runs over the set

$$\{t_8t_7t_6t_4t_5t_2t_4t_3t_1, t_8t_7t_6t_5t_4t_2t_4t_3t_1, t_8t_7t_6t_5t_4t_5t_2t_3t_1, t_8t_7t_6t_5t_5t_2t_4t_3t_1\}.$$

The cohomology of this variety fits in the following long exact sequence, for any cuspidal character ρ

$$\cdots \longrightarrow H_c^i(X(w))_\rho \longrightarrow H_c^i(\overline{X}(w))_\rho \longrightarrow H_c^i(Z)_\rho \longrightarrow \cdots \quad (2.24)$$

The elements of the Braid monoid obtained by un-underlying the elements v will be denoted by $\mathbf{v}_1, \mathbf{v}_2, \mathbf{v}_3$ et \mathbf{v}_4 . Note that only \mathbf{v}_4 is not the canonical lift of an element of W . For $j = 1, 2, 3$, the cuspidal part of the cohomology of $X(\mathbf{v}_j) \simeq X(v_j)$ can be deduced from the following exact sequence

$$\cdots \longrightarrow H_c^i(X(v_j))_\rho \longrightarrow H_c^i(\overline{X}(v_j))_\rho \longrightarrow (H_c^i(\overline{X}(c))_\rho)^{\oplus 2} \longrightarrow \cdots$$

together with the following properties

- the cuspidal part of $H_c^*(\overline{X}(v_j))$ can be explicitly computed using (C3):

$$\underline{H}_{\overline{X}(v_j)} = (h^8t^4 + h^{10}t^5)(E_8[-\theta] + E_8[-\theta^2] + E_8[\zeta] + E_8[\zeta^2] + E_8[\zeta^3] + E_8[\zeta^4])$$

- the cuspidal part of a variety associated to a Coxeter element is given by [20] (or equivalently can be computed using (C3)):

$$\underline{H}_{\overline{X}(c)} = h^8t^4(E_8[-\theta] + E_8[-\theta^2] + E_8[\zeta] + E_8[\zeta^2] + E_8[\zeta^3] + E_8[\zeta^4])$$

- the cohomology of $X(v_j)$ vanishes in degree 8.

We obtain, for $j = 1, 2, 3$:

$$\underline{H}_{X(v_j)} = (h^9 t^4 + h^{10} t^5)(\mathbf{E}_8[-\theta] + \mathbf{E}_8[-\theta^2] + \mathbf{E}_8[\zeta] + \mathbf{E}_8[\zeta^2] + \mathbf{E}_8[\zeta^3] + \mathbf{E}_8[\zeta^4]).$$

Using [11, Proposition 3.2.10], one can check that it is also the cuspidal part of the cohomology of $X(\mathbf{v}_4)$.

We claim that we can derive the cohomology of Z : for any cuspidal character ρ , we have an exact sequence

$$\cdots \longrightarrow \bigoplus_{j=1}^4 \mathbf{H}_c^i(X(\mathbf{v}_j))_\rho \longrightarrow \mathbf{H}_c^i(Z)_\rho \longrightarrow (\mathbf{H}_c^i(X(c))_\rho)^{\oplus 4} \longrightarrow \cdots$$

Furthermore, the cohomology of $X(w)$ vanishes in degree 9 and the cuspidal part of $\mathbf{H}_c^\bullet(\overline{X}(w))$ is concentrated in degree 10, given by

$$h^{10} t^5 (\mathbf{E}_8[i] + \mathbf{E}_8[-i] + 3(\mathbf{E}_8[-\theta] + \mathbf{E}_8[-\theta^2]) + 4(\mathbf{E}_8[\zeta] + \mathbf{E}_8[\zeta^2] + \mathbf{E}_8[\zeta^3] + \mathbf{E}_8[\zeta^4]))$$

Consequently, the cuspidal part of $\mathbf{H}_c^8(Z)$ is zero by 2.24 and we obtain

$$\underline{H}_Z = 4h^{10} t^5 (\mathbf{E}_8[-\theta] + \mathbf{E}_8[-\theta^2] + \mathbf{E}_8[\zeta] + \mathbf{E}_8[\zeta^2] + \mathbf{E}_8[\zeta^3] + \mathbf{E}_8[\zeta^4]).$$

In particular, we can unpack the exact sequence 2.24 according to the different cuspidal characters as follows

$$0 \longrightarrow \mathbf{H}_c^{10}(X(w))_{\mathbf{E}_8[\pm i]} \longrightarrow t^5 \mathbf{E}_8[\pm i] \longrightarrow 0$$

$$0 \longrightarrow \mathbf{H}_c^{10}(X(w))_{\mathbf{E}_8[-\theta^i]} \longrightarrow 3t^5 \mathbf{E}_8[-\theta^i] \longrightarrow 4t^5 \mathbf{E}_8[-\theta^i] \longrightarrow \mathbf{H}_c^{11}(X(w))_{\mathbf{E}_8[-\theta^i]} \longrightarrow 0$$

$$0 \longrightarrow \mathbf{H}_c^{10}(X(w))_{\mathbf{E}_8[\zeta^j]} \longrightarrow 4t^5 \mathbf{E}_8[\zeta^j] \longrightarrow 4t^5 \mathbf{E}_8[\zeta^j] \longrightarrow \mathbf{H}_c^{11}(X(w))_{\mathbf{E}_8[\zeta^j]} \longrightarrow 0$$

To conclude, we observe that the unipotent characters $\mathbf{E}_8[-\theta^i]$ and $\mathbf{E}_8[\zeta^j]$ already appear in the Coxeter variety, and for that reason they cannot be constituents of $\mathbf{H}_c^{10}(X(w))$ with an eigenvalue of absolute value q^5 (see (C4)).

Proposition 2.25. *Let $w = t_8 t_7 t_6 t_5 t_4 t_5 t_2 t_4 t_3 t_1$. The cuspidal part of the cohomology of $X(w)$ is given by*

$$h^{10} t^5 (\mathbf{E}_8[i] + \mathbf{E}_8[-i]) + h^{11} t^5 (\mathbf{E}_8[-\theta] + \mathbf{E}_8[-\theta^2]).$$

2.4.3. Cohomology of $X(w)$. We summarize the results obtained in this section. The unipotent characters in the principal Φ_{24} -bloc b are given by

$$\begin{aligned} b_{\text{uni}} = \{ & \text{Id}_G, \text{St}_G, \phi_{35,74}, \phi_{160,55}, \phi_{350,38}, \phi_{448,25}, \phi_{350,14}, \phi_{160,16}, \phi_{35,2}, D_{4,\phi_{2,16}'}, \\ & D_{4,\phi_{8,9}'}, D_{4,\phi_{12,4}'}, D_{4,\phi_{8,3}'}, D_{4,\phi_{2,4}'}, E_6[\theta]_{\phi_{1,3}'}, E_6[\theta]_{\phi_{2,2}'}, E_6[\theta]_{\phi_{1,3}''}, E_6[\theta^2]_{\phi_{1,3}'}, \\ & E_6[\theta^2]_{\phi_{2,2}'}, E_6[\theta^2]_{\phi_{1,3}''}, E_8[i], E_8[-i], E_8[-\theta], E_8[-\theta^2] \} \end{aligned}$$

By comparing the restriction to E_7 of these characters and Proposition 2.22, 2.23 and 2.25 we obtain a good approximation of the cohomology of $X(w)$.

Theorem 2.26. *Let (G, F) be a split group of type E_8 and w be a good 24-regular element of W . The contribution to the cohomology of the Deligne-Lusztig $X(w)$ of the principal series, the D_4 -series, the E_6 -series and the cuspidal characters coincides with the contribution of the principal Φ_{24} -block, and it is given by*

i	10	11	12	13
$bH^i(X(w), \overline{\mathbb{Q}}_\ell)$	St $-q^3 D_{4, \phi''_{2,16}}$ $\theta q^4 E_6[\theta]_{\phi'_{1,3}}$ $\theta^2 q^4 E_6[\theta^2]_{\phi'_{1,3}}$ $i q^5 E_8[i]$ $-i q^5 E_8[-i]$	$q^2 \phi_{35,74}$ $-q^4 D_{4, \phi''_{8,9}}$ $\theta q^5 E_6[\theta]_{\phi_{2,2}}$ $\theta^2 q^5 E_6[\theta^2]_{\phi_{2,2}}$ $-\theta q^5 E_8[-\theta]$ $-\theta^2 q^5 E_8[-\theta^2]$	$q^3 \phi_{160,55}$ $-q^5 D_{4, \phi_{12,4}}$ $\theta q^6 E_6[\theta]_{\phi''_{1,3}}$ $\theta^2 q^6 E_6[\theta^2]_{\phi''_{1,3}}$	$q^4 \phi_{350,38}$ $-q^6 D_{4, \phi'_{8,3}}$

i	14	15	16	17	18	19	20
$bH^i(X(w), \overline{\mathbb{Q}}_\ell)$	$q^5 \phi_{448,25}$ $-q^7 D_{4, \phi'_{2,4}}$	$q^6 \phi_{350,14}$	$q^7 \phi_{160,7}$	$q^8 \phi_{35,2}$			$q^{10} \text{Id}$

where the D_4 -series is given under Assumption 2.16 and the E_6 -series under Assumption 2.21.

3 Conjectures on associated Brauer trees

Having computed the cohomology of some Deligne-Lusztig varieties for exceptional groups, we would like to propose conjectures on Brauer trees for the corresponding principal Φ_d -blocks.

Recall from [2] that if d is a regular number, and w is a d -regular element, the irreducible constituent of the virtual character $R_{T_w}^G(1) = \sum (-1)^i H_c(X(w), \overline{\mathbb{Q}}_\ell)$ are exactly the unipotent characters in the principal Φ_d -block. If moreover $C_W(wF) \simeq N_G(\mathbf{T}_w)/C_G(\mathbf{T}_w)$ is cyclic, then the Φ_d -block is generically of cyclic defect: if ℓ divides $\Phi_d(q)$ but does not divide $|W|$, then any Sylow subgroup of G is cyclic. In that case, the representation theory of the block (i.e. the module category over the block) can be described by its Brauer tree. More precisely, in this situation:

- any ℓ -character θ of T_w is in general position and the associated irreducible character $\chi_\theta = (-1)^{\ell(w)} R_{T_w}^G(\theta)$ is cuspidal by [21, Proposition 2.18]. Moreover, using [8, Proposition 12.2] it can be shown that its restriction to the set of ℓ -regular elements is independent from θ . Any character of this form is said to be a *exceptional*;

- there are $e = |C_W(w)|$ unipotent characters $\{\chi_0, \dots, \chi_{e-1}\}$ in the block, which will be referred as the *non-exceptional* characters;

Now if we consider the sum χ_{exc} of all distinct unipotent characters, any projective indecomposable $\overline{\mathbb{F}}_\ell G$ -module lifts uniquely, up to isomorphism, to a $\overline{\mathbb{Z}}_\ell$ -module P whose character is $[P] = \chi + \chi'$ for χ, χ' two distinct characters in $\mathcal{V} = \{\chi_{\text{exc}}, \chi_0, \dots, \chi_{e-1}\}$. We define the *Brauer tree* Γ of the block to be the graph with vertices labelled by \mathcal{V} and edges $\chi - \chi'$ whenever there exists a projective indecomposable module with character $\chi + \chi'$. This graph is a tree and its planar embedding determines the module category over the block up to Morita equivalence.

When $d = h$ is a the Coxeter number, Hiss, Lübeck and Malle have formulated in [19] a conjecture relating the cohomology of the Deligne-Lusztig variety associated to a Coxeter element (together with the action of F) and the planar embedded Brauer tree of the principal Φ_h -block. Using the explicit results on the cohomology of Deligne-Lusztig varieties that we have obtained, and the Brauer trees that we already already know from [18] and [19], we shall propose two conjectural Brauer trees for groups of type E_7 and E_8 .

3.1 Observations

Let (\mathbf{G}, F) be a split group of type F_4 and w be a good 8-regular element. When ℓ divides $\Phi_8(q)$ and does not divide the order of W , we can observe that the classes in \mathbb{F}_ℓ of the eigenvalues of F on $bH_c^*(X(w), \overline{\mathbb{Q}}_\ell)$ form the group of 8th roots of unity, generated by the class of q . Therefore to any non-exceptional character χ one can associate an integer j_χ such that the class of the corresponding eigenvalue of F coincides with the class of q^{j_χ} . By [18], the Brauer tree of the block, together with the integers j_χ is given by

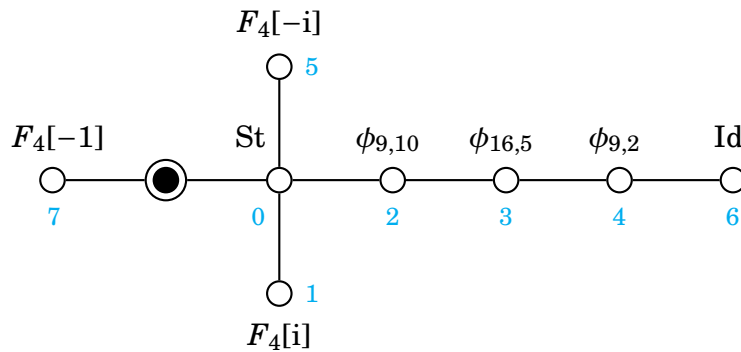
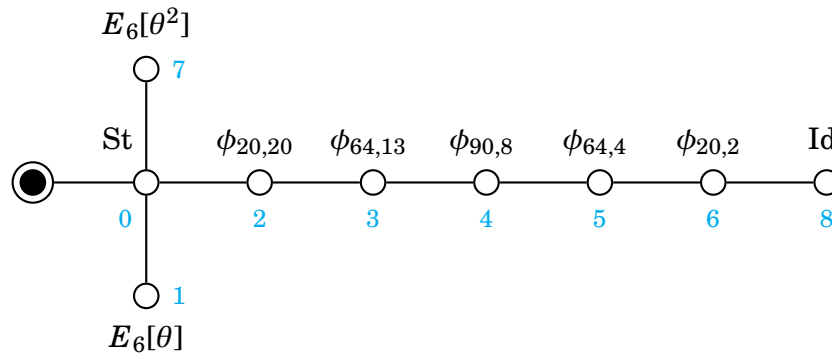

Figure 1: Brauer tree of the principal Φ_8 -block of F_4

Now assume that (\mathbf{G}, F) is a split group of type E_6 . The Brauer tree of the principal Φ_9 -block of G has been determined in [19]. It corresponds to the following picture:

Figure 2: Brauer tree of the principal Φ_9 -block of E_6

Remark 3.1. Unlike the Coxeter case (see [12] and [13]), the cohomology of the Deligne-Lusztig variety $\tilde{X}(w)$ with coefficients in \mathbb{Z}_ℓ is not torsion-free. Indeed, it is impossible to represent the generalized (q^2) -eigenspace of F on $\tilde{X}(w)$ with a complex of projective modules $0 \rightarrow P \xrightarrow{f} Q \rightarrow 0$ where the cokernel of f is torsion-free. Note that even the cohomology of the complex constructed by Rickard in [23, Section 4] will also have a non-trivial torsion part (one can show nevertheless that the torsion is always cuspidal).

3.2 Conjectures

From the results obtained in Theorem 2.20 and 2.26, it is not difficult to extrapolate the previous trees to the case of E_7 and E_8 . We conjecture that the Brauer trees of the principal Φ_{14} -block in E_7 and the principal Φ_{24} -block in E_8 are given by Figure 3 and 4. Note that

- the lines represented by each Harish-Chandra series, as well as the real steam, are known from [16];
- the simple modules corresponding to edges connecting two different series are necessarily cuspidal.

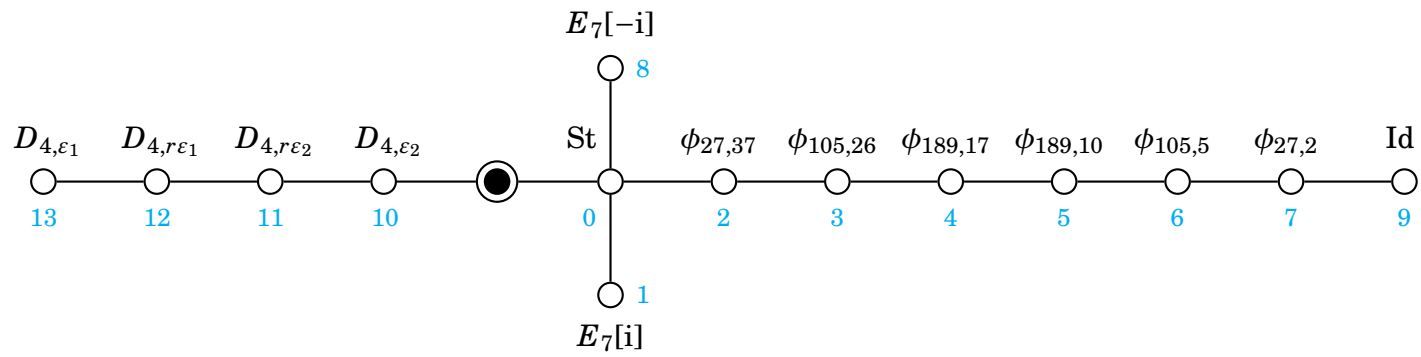

Figure 3: Brauer tree of the principal Φ_{14} -block of E_7

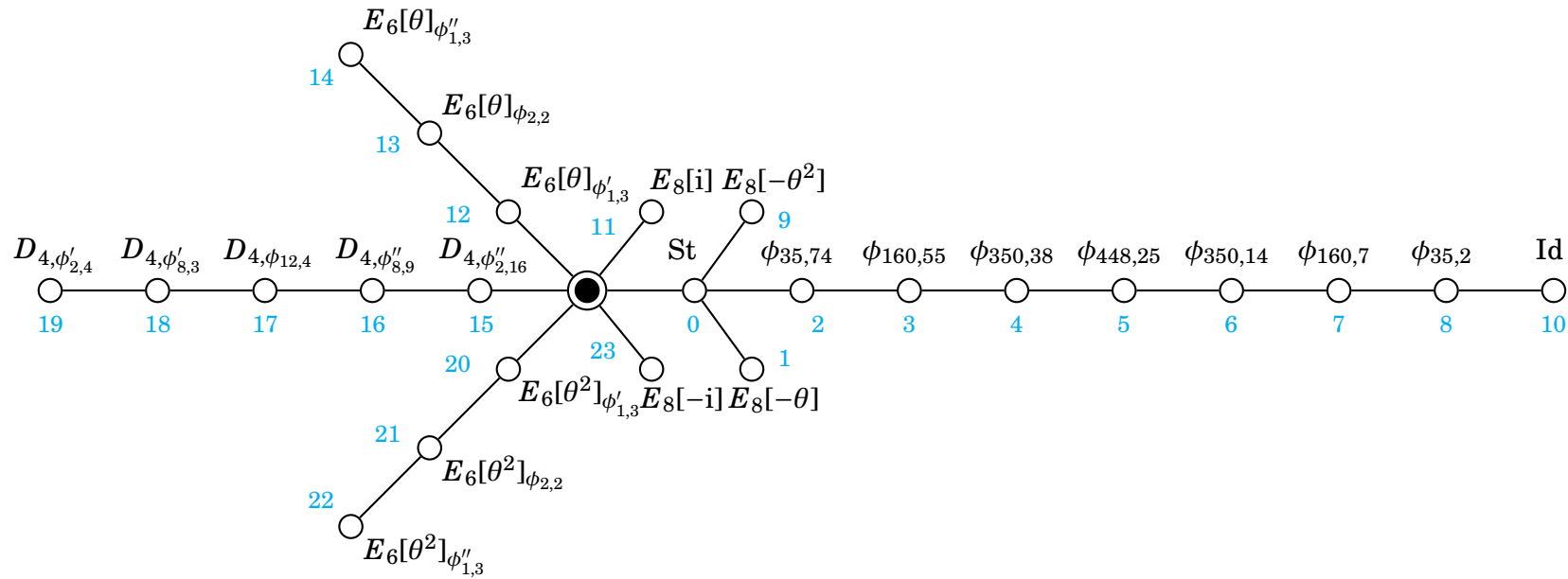

Figure 4: Brauer tree of the principal Φ_{24} -block of E_8

Acknowledgements

I am indebted to Jean Michel for introducing me to the methods of [11] and [9] which I have used throughout this paper. Most of this work was carried out while I was visiting him and François Digne. I would like to thank them for many valuable comments and suggestions.

References

- [1] D. Bessis. Finite complex reflection arrangements are $k(\pi, 1)$, arXiv:math.gt/0610777. *Preprint*, 2006.
- [2] M. Broué, G. Malle, and J. Michel. Generic blocks of finite reductive groups. *Astérisque*, (212):7–92, 1993. Représentations unipotentes génériques et blocs des groupes réductifs finis.
- [3] M. Broué and J. Michel. Sur certains éléments réguliers des groupes de Weyl et les variétés de Deligne-Lusztig associées. In *Finite reductive groups (Luminy, 1994)*, volume 141 of *Progr. Math.*, pages 73–139.
- [4] M. Broué and J. Michel. Blocs et séries de Lusztig dans un groupe réductif fini. *J. Reine Angew. Math.*, 395:56–67, 1989.
- [5] R. W. Carter. *Finite groups of Lie type*. Wiley Classics Library. John Wiley & Sons Ltd., Chichester, 1993. Conjugacy classes and complex characters, Reprint of the 1985 original, A Wiley-Interscience Publication.
- [6] D. Craven. On the cohomology of Deligne-Lusztig varieties, arXiv:math/1107.1871. *Preprint*, 2011.
- [7] P. Deligne and G. Lusztig. Representations of reductive groups over finite fields. *Ann. of Math. (2)*, 103(1):103–161, 1976.
- [8] F. Digne and J. Michel. *Representations of finite groups of Lie type*, volume 21 of *London Mathematical Society Student Texts*. Cambridge University Press, Cambridge, 1991.
- [9] F. Digne and J. Michel. Endomorphisms of Deligne-Lusztig varieties. *Nagoya Math. J.*, 183:35–103, 2006.
- [10] F. Digne and J. Michel. Parabolic Deligne-Lusztig varieties, arXiv:math/1110.4863. *preprint*, 2011.
- [11] F. Digne, J. Michel, and R. Rouquier. Cohomologie des variétés de Deligne-Lusztig. *Adv. Math.*, 209(2):749–822, 2007.
- [12] O. Dudas. Coxeter Orbits and Brauer trees I, arXiv:math/1011.5476. *preprint*, 2010.

- [13] O. Dudas. Coxeter Orbits and Brauer trees II, arXiv:math/1011.5478. *preprint*, 2010.
- [14] O. Dudas. Quotient of Deligne-Lusztig varieties, arXiv:math/1112.4942. *preprint*, 2011.
- [15] O. Dudas and R. Rouquier. Coxeter Orbits and Brauer trees III. *in preparation*, 2011.
- [16] M. Geck. Brauer trees of Hecke algebras. *Comm. Algebra*, 20(10):2937–2973, 1992.
- [17] A. Grothendieck and al. *Théorie des topos et cohomologie étale des schémas. Tome 2*. Lecture Notes in Mathematics, Vol. 270. Springer-Verlag, Berlin, 1972. Séminaire de Géométrie Algébrique du Bois-Marie 1963–1964 (SGA 4).
- [18] G. Hiss and F. Lübeck. The Brauer trees of the exceptional Chevalley groups of types F_4 and 2E_6 . *Arch. Math. (Basel)*, 70(1):16–21, 1998.
- [19] G. Hiss, F. Lübeck, and G. Malle. The Brauer trees of the exceptional Chevalley groups of type E_6 . *Manuscripta Math.*, 87(1):131–144, 1995.
- [20] G. Lusztig. Coxeter orbits and eigenspaces of Frobenius. *Invent. Math.*, 38(2):101–159, 1976/77.
- [21] G. Lusztig. Representations of finite Chevalley groups. 39:v+48, 1978. Expository lectures from the CBMS Regional Conference held at Madison, Wis., August 8–12, 1977.
- [22] J. Michel. Development version of the GAP part of CHEVIE, see <http://www.institut.math.jussieu.fr/~jmichel/chevie/chevie.html>.
- [23] J. Rickard. Derived categories and stable equivalence. *J. Pure Appl. Algebra*, 61(3):303–317, 1989.
- [24] J. Rickard. Morita theory for derived categories. *J. London Math. Soc. (2)*, 39(3):436–456, 1989.
- [25] T. A. Springer. Regular elements of finite reflection groups. *Invent. Math.*, 25:159–198, 1974.