



HAL
open science

The adjustment and monitoring of freeform surfaces using inertial tolerancing.

Dimitri Denimal, Maurice Pillet, Alain Sergent

► **To cite this version:**

Dimitri Denimal, Maurice Pillet, Alain Sergent. The adjustment and monitoring of freeform surfaces using inertial tolerancing.. ASIGURAREA CALITATII - QUALITY ASSURANCE, 2011, XVII (65). hal-00651111

HAL Id: hal-00651111

<https://hal.science/hal-00651111>

Submitted on 2 Jan 2012

HAL is a multi-disciplinary open access archive for the deposit and dissemination of scientific research documents, whether they are published or not. The documents may come from teaching and research institutions in France or abroad, or from public or private research centers.

L'archive ouverte pluridisciplinaire **HAL**, est destinée au dépôt et à la diffusion de documents scientifiques de niveau recherche, publiés ou non, émanant des établissements d'enseignement et de recherche français ou étrangers, des laboratoires publics ou privés.

The Adjustment and Monitoring of Freeform Surfaces using Inertial Tolerancing

Dimitri DENIMAL, Maurice PILLET*, Alain SERGENT

Symme Laboratory, University of Savoie, Annecy, France

Abstract

At present, the manufacturing process allows one to make parts easily having one or several freeform surfaces thanks to the numerical link between Computer Aided Design (CAD) and Computer Numerical Control (CNC). Indeed, from a part defined by a CAD software the designer realizes the program of the CNC and can produce, if the CNC is supplied. However, during the step of production, the operator meets some difficulties to monitor and control. Indeed the ISO tolerancing of this kind of part is often complex and the setting of the manufacturer process is complex to adjust a part to its target values (numerical model). In this paper, we propose an original approach which simplifies the monitoring of freeform surface. We introduce this approach, we present the concept and we conclude by two industrial cases.

Keywords: *Monitoring, freeform surface, tolerance, measure.*

1. INTRODUCTION

In recent years, the development process has covered all the automated production phases, from the design to manufacture and finally through to the inspection of the parts. Since then, the design and the manufacture of complex surfaces has become a current practice in industry. Thus, the literature presents different works on the tool path generation using the digital model of a part (Duc E et al 1999, Li H et al, 2004), the metrology of freeform-shaped parts (Li Y et al, 2005, Savio E, 2007 or Jiang X et al, 2007), the monitoring of freeform surfaces (Yang My et al 1993, Klocke et al, 2008), or the certification method for the milling process (Thiebaut F et al, 1999, and Cho HD, 1993). These studies essentially highlight the problems related to the conformity and the production of parts with freeform surfaces.

This paper takes an interest in the monitoring and adjustment of the milling process which allows a part composed of one or a set of freeform surfaces to be obtained. The aim is to introduce an approach which allows a quick and efficient adjustment of a manufactured process using a group of measured deviations.

In the context of milling machines, we have identified three approaches which deduce the correction values using measured points (obtained by Coordinate Measuring Machines (CMM)).

- The first approach consists in defining the spatial location the volume of a numerical part inside a cast part before a machining operation. The principle is the following, from a measured cast part the approach computes the parameters of the process in function of several defined. These requirements can be functional, physical... The spatial location is defined mathematically by a transfer matrix between the reference system of the cast part (R_0) and the reference system of the numerical part (*Figure 1*) (Li and Gu, Y 2005) (Frank Fontanili 1992)
- The second approach is to consider the tool path as an invariable, but it can be affected by the variation in the parameters of the tool (for example, the corrector of a tool). Consequently, the aim is to adjust the path of the tool using the parameters of the tool. *Figure 2* is an illustration of the second approach. The numerical model is

* Correspondence to Prof.dr. Maurice Pillet, e-mail: srdjan.tomic76@gmail.com.

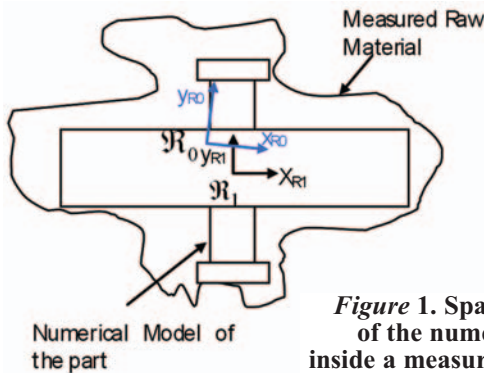

Figure 1. Spatial location of the numerical model inside a measured cast part

presented by a dashed line and the measured part by a continuous line. Consequently, if you want the measured part to be on the target, one must adjust the parameters CR and CL (Figure 2).

- The third approach consists in the adjustment of the path tool to a group of measured points. For example, we want to machine a porthole in a hull. During the machining operation, the hull is put onto three supports (Isostatic support) therefore the hull bends because of the weight of the keel. Thus, the form of the porthole becomes elliptic. Hence, the question is what is the path of the tool to guarantee a circular porthole in a real context (when the hull is on the sea)? The response consists in adapting the path tool in function of the bend of the hull.

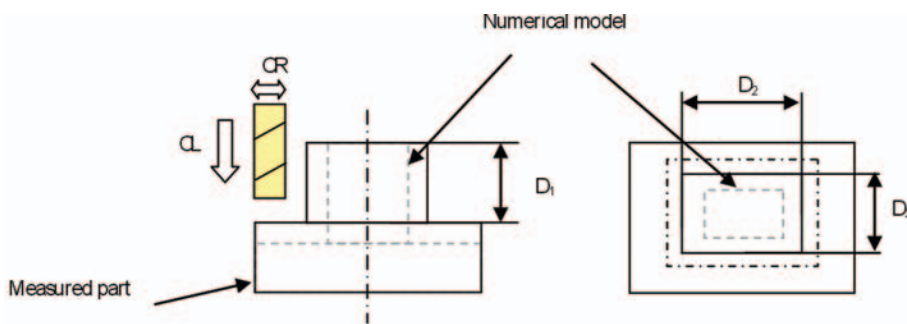

Figure 2. Adjustment of the tool

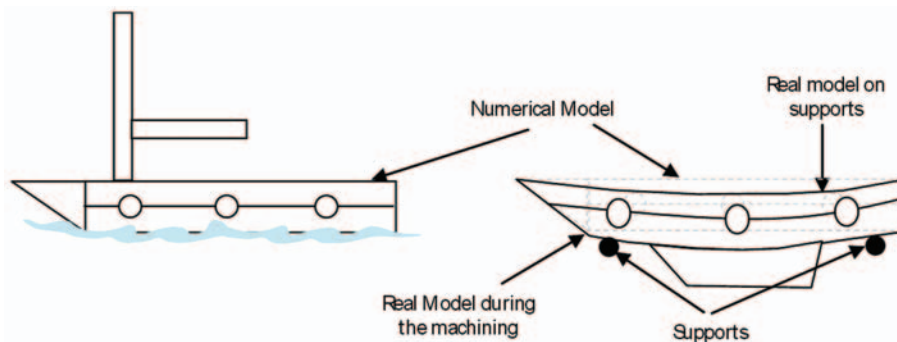

Figure 3. Adaptive path tool

The first and the third approaches have been introduced in several works by different authors (Li 2005, Dubois 2008, Desplatz 2008, Goldschmidt 2009, Bouchenitfa 2009). In addition, a collaboration with the company DELCAM[©] and CETIM (French Technical Centre for Mechanical Industry) has developed a software programme (Power Milling[©]) which allows us to adapt the tool path using a measured part. Nevertheless, to our knowledge, the second approach has not been introduced in research yet. Indeed, we think that the first and the third approaches are really adapted to fit a part on the numerical model, consequently these approaches mainly concern small production batches and the calculation takes some time.

In the context of mass production, the second approach seems more adapted if the calculation time takes a few seconds. In fact, our industrial backgrounds show us that the adjustment phase can be strenuous and very time-consuming.

In this paper, we will firstly present the mathematical principle of our method, and secondly, two industrial case studies.

2. PRESENTATION OF THE MATHEMATICAL PROCEDURE

2.1. General approach

The aim of a production is to comply with the functional requirements. These requirements are materialized by a numerical model of a part for which a level of variability is defined on each surface. Since any manufacturing process induces variability, the control of the process is required in order to respect the required level of variability.

By achieving a balance in the production environment it finds that:

- The manufacturing process is controlled through a group of correctors which is defined by a vector, Y . For example, in the case of a CNC machine, these correctors can be an offset, a radius corrector, a corrector of rotation... The size of the vector Y is equal to the number of available parameters to adjust a given part.

□ The machined part has deviations in comparison to its numerical model (*NM*). These differences are represented by a vector *E* which corresponds to the differences between the target (*NM*) and the measured values. This vector contains all the deviations and its size is relative to the number of measured points. For example, in the case of scanning, the size of the vector *E* is equal to several thousand points.

We propose to link these two vectors (*Y* and *E*) by a linear relationship matrix (1). We call this matrix: incidence matrix *X*. The incidence matrix synthesizes the impact of each corrector (*Y*) on each measured point (*E*). Consequently, by knowing one of the vectors (*Y* or *E*), it is possible to deduce the other:

$$E = XY \tag{1}$$

The parameter *X* in the relation (1) corresponds to a matrix which describes the relation between the vectors *E* and *Y*. Its dimension is equal to *m* x *n* for which *m* is the size of the vector *Y* and *n* the size of the vector *E*. This matrix is called an incidence matrix. The impact of each corrector is calculated using the normal of the numerical surface of each point, we present this point in the part „Determination of the matrix *X*“.

The main purpose is to suggest the adjustment in order to reduce or eliminate the set of deviations (Vector *E*). The relation (1) defines a set of inequalities and, to solve this mathematical operation, we suggest calculating the pseudo inverse of the incidence matrix *X* (Saporta 2006, Nisbet 2009). The pseudo-inverse method corresponds to at least the square optimization, we call this pseudo-inverse, *X**.

$$X^* = (X'X)^{-1} X' \tag{2}$$

Finally, the relation (3) presents the mathematical model which gives the adjustment vector (*Y*) for a deviation vector, *E*.

$$Y = X^* E' \tag{3}$$

In the next parts, we will present the calculation of the *E* vector and then the *X* matrix.

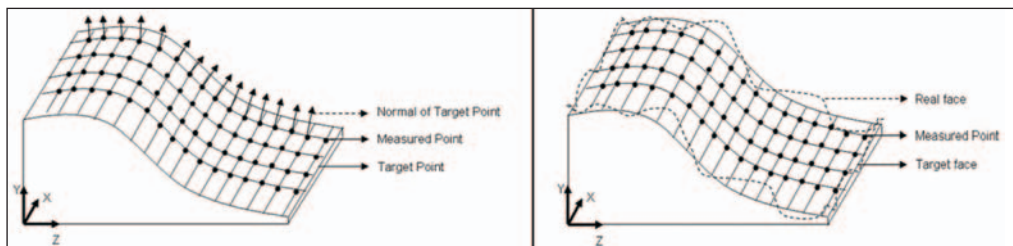

Figure 4. Illustration of the *E* vector

2.2. Determination of the vector *E*

The vector *E* is composed of a set of scalar projection of the deviation δ_i between the coordinate of the measured point and the target point appertaining to the theoretical topology of surfaces (Figure 4) (Equation (4)).

$$E = \begin{pmatrix} \delta_1 \\ \delta_2 \\ \dots \\ \delta_n \end{pmatrix} \tag{4}$$

The coordinate of the measured point and the target point are defined in the CMM reference system. For a target point *i*, the deviation δ between the measured and the target is formulated by:

$$\delta_i = \vec{T_i X_i} \cdot \vec{n_i} = \begin{pmatrix} X_{xi} & T_{xi} \\ X_{yi} & T_{yi} \\ X_{zi} & T_{zi} \end{pmatrix} \cdot \begin{pmatrix} n_{xi} \\ n_{yi} \\ n_{zi} \end{pmatrix} \tag{5}$$

Note that:

X_i : Measured point *i* in the CMM reference system,

T_i : Target point *i* in the CMM reference system,

n_i : Normal Vector of the target point *i*.

The normal vector is normalized and it is defined as positive on the external side of the surface.

This approach implies that the CMM measure is in accordance with the normal vector of the target point *i*.

From the relation (4), we can represent the overall defect of the part by a scalar. This scalar is called inertia of the part *i* (Pillet 2004, Adragna 2007).

$$I_E = \sqrt{\frac{1}{n} \sum_{i=1}^n \delta_i^2} \tag{6}$$

This last relation is used to evaluate the overall defect of the part.

2.3. Determination of the matrix *X*

In the case of the milling process, the incidence matrix *X* is composed of a set of correctors (*C_i*) which are independent and for which the impact has been calculated for each measured point.

Nowadays, the milling machine presents the operator with a lot of possibilities of adjustment. Consequently in this part, we will present an approach to build the

matrix X of the milling process using a set of correctors. We introduce four kinds of correctors and discuss the building of the X matrix in the case of injection molding machines.

2.3.1. Location Corrector (Dec)

Figure 5 (a) illustrates the location of a hole in a reference system (RS) of the measure. Here, we consider the RS of the measure to coincide with the RS of the machine. In order to adjust the location of the hole, the machine operator can modify the corrector DEC_1 and the corrector DEC_2 . The first corrector adjusts following the x -axis and the second, following the y -axis.

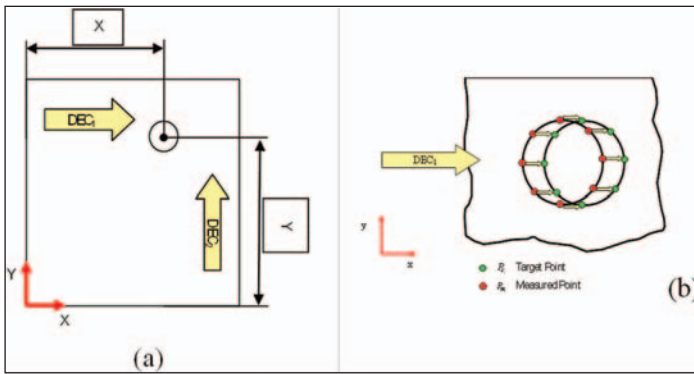

Figure 5. Location of a hole

Figure 5 (b) presents the location problem. The operator would like to adjust the hole location. In Figure 5 (b), the target hole location is presented by a circle defined by 8 green points (P_{Ti}). The measured location is given by the 8 red points (P_{Mi}). The yellow arrows correspond to the value of the adjustment on the x axis. The influence of the corrector DEC_1 is calculated using the impact on the measured point following the direction of the corrector \vec{n}_i for one unit.

$$DEC_i = \overrightarrow{(P_{C_i}P_{M_i})} \cdot \vec{n}_i \quad (7)$$

With \cdot corresponding to the scalar product.

2.3.2. Length Corrector (L)

Figure 6 (a) shows the principle of the length corrector. The dashed line is the target framework while the continuous line presents the measured framework. Each surface is defined by a set of points; the target point (P_{Ti}) in the RS, and R_0 and P_{Mi} on the measured point. The deviation between P_{Ti} and P_{Mi} following the normal direction to the surface targeted correspond to the deviation to adjust.

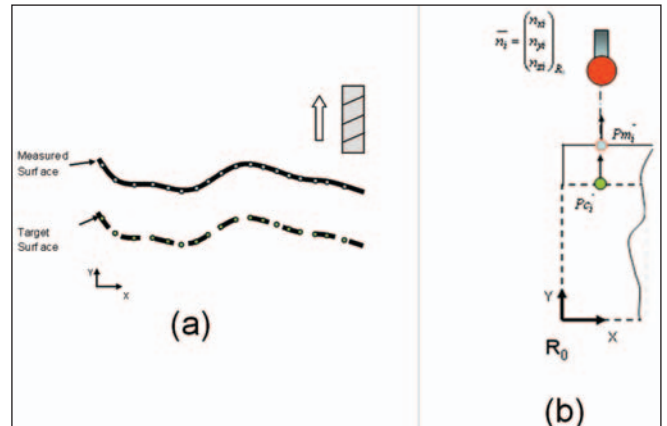

Figure 6. Principle of the length corrector

The impact of the corrector L_i is given by the relation:

$$L_i = \overrightarrow{(P_{C_i}P_{M_i})} \cdot \vec{n}_i \quad (8)$$

2.3.3. Rotation corrector (R)

This corrector corresponds to a rotation of the tool or of the support of the machine part. The impact of this third corrector is calculated using the same principle as for the previous correctors. But it integrates another parameter which is the location of the centre of rotation.

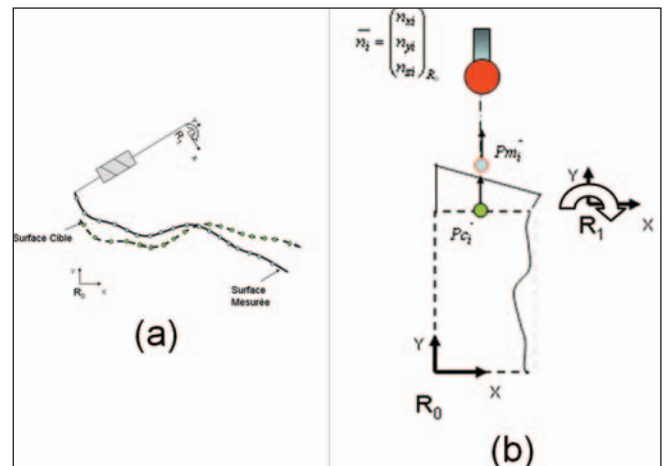

Figure 7. Principle of the Rotation corrector

To express the impact of this corrector on the measured point, we assume that the deviation is always in the small displacement context.

$$O_i = \overrightarrow{(R_0R_1)} + \overrightarrow{(P_{C_i}P_{M_i})_{R_1}} \wedge \overrightarrow{R_{mobility}} \cdot \vec{n}_i \quad (9)$$

With $\overrightarrow{R_{mobility}}$ corresponding to the degree of rotation following a rotation axis (x, y, z -axis), \vec{n}_i is the normal

ASIGURAREA CALITĂȚII – QUALITY ASSURANCE

Ianuarie – Martie 2011 Anul XVII Numărul 65

vector on the surface at point i and $\vec{R}_0\vec{R}_1$ is the vector between the reference system R_0 et R_1 .

2.3.4. Radius corrector

If the tool path creates an outline of a part, the impact of the radius corrector on the part corresponds to a homothetic transformation. *Figure 8* illustrates the influence of this corrector. We can see the target surface represented by a mixed point, the path of the tool is a dashed arrow and tool is a colour circle. The continuous lines correspond to the measured surface.

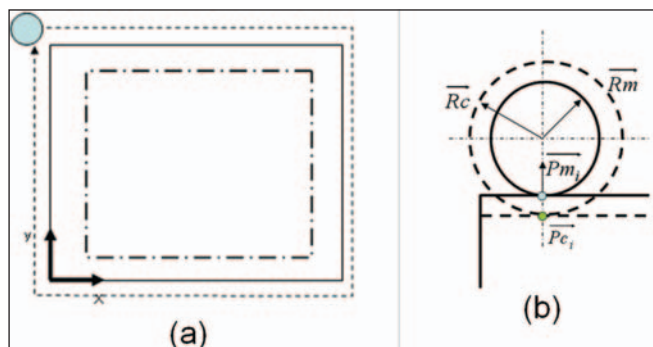

Figure 8. Principle of the Radius corrector

The variation of the radius impacts the deviation of the point i following the normal of the target surface.

$$R_i = (\vec{Pc}_i\vec{Pm}_i) \cdot \vec{n}_i \Rightarrow r \cdot \|\vec{n}_i\|^2 = r \quad (10)$$

With r as the radius of the tool.

In this paper, we have presented the most important correctors but it is also possible to introduce other correctors such as corrector of the radius of a curvature...

2.4. Adjustment Efficiency Indicator (AEI)

The main purpose of this indicator is to characterize the effectiveness of the proposed adjustment (Y) in relation to the measured deviation (E).

Its indicator is called „Adjustment Efficiency Indicator“ (*AEI*) (11). It is a ratio between the sum of the squared measured deviation (S_E) and the sum of the theoretical result from the proposed adjustment (S_Y). The theoretical result corresponds to the predicted deviation from the in-

cidence matrix, X . Thus, if a part is measured after the proposed adjustment, it's possible to note a deviation between S_Y , defined theoretically, and the S_Y^* calculated using the measured part. This difference depends on process and measure variability.

$$IEA = 100(1 - \frac{S_Y}{S_E}) = 100(1 - \frac{\sum \delta_{Yi}^2}{\sum \delta_{Ei}^2}) \quad (11)$$

If the *IEA* is equal to 100%, we must understand that all the deviations are corrected so that part is almost similar to the numerical part. Consequently, if the *IEA* is equal to a value of less than $k\%$ of 100%, it means that the proposed adjustments only correct $k\%$ of the deviations. The convergence of $k\%$ to 100% is dependent on the number and kind of correctors (C_i) chosen during the construction of the incidence matrix X . From the application point of view, we recommend retaining the most relevant correctors among the dozens often offered by the different processes. Thus, one role of industrialization will be to look for the 20% of the correctors in order to correct 100% of the deviations, in 80% of the cases encountered by the machinist.

3. INDUSTRIAL CASE WITH ISO GPS

This industrial case shows the satisfaction of geometrical product specifications (ISO 8015) with the *TIT*. The presented case is a part which allows one to check the geometry of a milling machine. The part is presented in *Figure 9* (a) and it is measured at 32 points by a Coordinate Measuring Machine (*CMM*).

3.1. Study Case

Figure 9 shows two reference systems. The first system is built according to the surfaces A, B, C while the second, based on the first datum is noted A, G, H . Thus, it is necessary for all the measured points to be

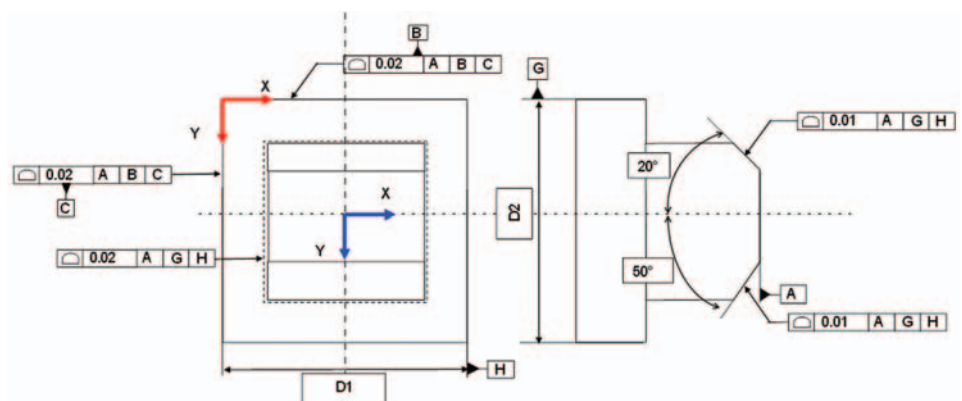

Figure 9. Example of a part with geometrical product specification (GPS)

expressed using the same reference system. Two transition matrices are needed; one for expressing the measured points in the same reference system during the measurement and another for expressing the measured points in the reference system of the machine.

The reference system *AGH* is based on the median plans which are dependent on the distances *D1* and *D2*. Accordingly, a deviation on *D1* or *D2* leads to a deviation of the reference system. (Figure 10)

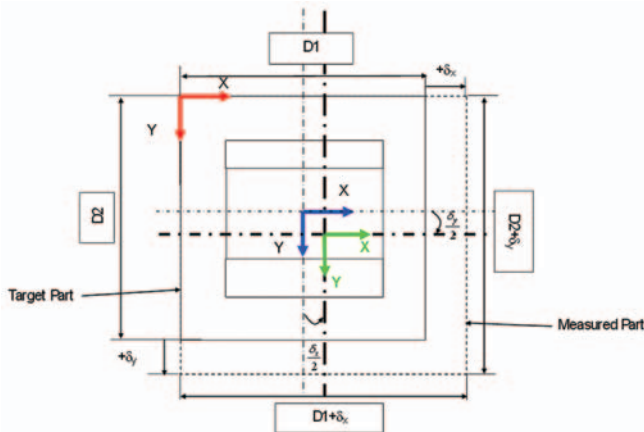

Figure 10. Evolution of the reference system depending on the deviation of the distance *D1* and *D2*

In Figure 10, we observe that for a deviation δ_x and δ_y , the deviation of the reference system corresponds to $\delta_x/2$ and $\delta_y/2$. Thus, it is possible to determine the transition matrix between the reference system *ABC* to the reference system *AGH*.

$$[P]_{R_{ABC} \rightarrow AGH} = \begin{bmatrix} 1 & 0 & 0 & \delta_x/2 \\ 0 & 1 & 0 & \delta_y/2 \\ 0 & 0 & 1 & 0 \\ 0 & 0 & 0 & 1 \end{bmatrix} \quad (12)$$

In this case, there is no orientation of the reference system and the *z* component is null because it pertains to the datum plan *A*.

From the transition matrix (12), it is possible to express the set of measured points in one measure reference system (*CMT*). Therefore, it is possible to define the transition matrix to the reference system of the machine. Nevertheless, in this case study, the reference system *AGH* coincided with the machine reference system. In consequently, all the measured points should be expressed using the *AGH* reference system.

3.2. Incidence matrix *X*

This part explains the construction of the incidence matrix *X*. Figure 11 presents the set of correctors that the machine has available in order to correct the part.

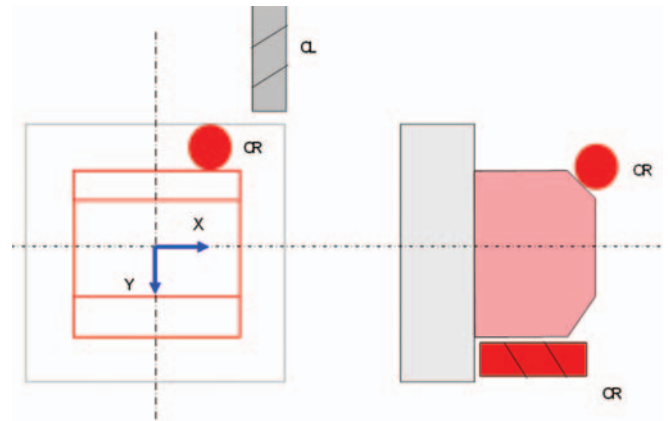

Figure 11. Part and Correctors

This case is composed of three correctors which are the length correctors (*LC*) and a radius corrector (*RC*). Nevertheless, these correctors are not sufficient to give an efficient adjustment concerning the inclined planes. Indeed, during the machining of the inclined planes, the production tool creates a modification of its location and its orientation. Consequently, it is necessary to consider a location corrector (*L_gC*) at the center of its tool. The impact of each corrector of every measured point is calculated for one unit (See Table 1) from the relations (8)(10)(7) for the *LC*, *RC*, and *L_gC* respectively.

Table 1. Incidence Matrix *X* for each Point

Incidence Matrix	<i>LC</i>	<i>RC</i>	<i>L_gC</i>
P1	-1	0	0
P2	-1	0	0
P3	-1	0	0
P4	-1	0	0
P5	-1	0	0
P6	-1	0	0
P7	-1	0	0
P8	-1	0	0
P9	-1	0	0
P10	-1	0	0
P11	-1	0	0
P12	-1	0	0
P13	0	0	0.707107
P14	0	0	0.707107
P15	0	0	0.707107
P16	0	0	0.707107
P17	0	0	0.5
P18	0	0	0.5
P19	0	0	0.5
P20	0	0	0.5
P21	0	1	0

Incidence Matrix	LC	RC	LgC
P22	0	1	0
P23	0	1	0
P24	0	1	0
P25	0	1	0
P26	0	1	0
P27	0	1	0
P28	0	1	0
P29	0	1	0
P30	0	1	0
P31	0	1	0
P32	0	1	0

From the Incidence Matrix, we define the matrix X^* by the relation (2).

Table 2. Matrix X^* for each Point

Matrix X^*	LC	RC	LgC
P1	-0.08	0	0
P2	-0.08	0	0
P3	-0.08	0	0
P4	-0.08	0	0
P5	-0.08	0	0
P6	-0.08	0	0
P7	-0.08	0	0
P8	-0.08	0	0
P9	-0.08	0	0
P10	-0.08	0	0
P11	-0.08	0	0
P12	-0.08	0	0
P13	0	0	0.236
P14	0	0	0.236
P15	0	0	0.236
P16	0	0	0.236
P17	0	0	0.167
P18	0	0	0.167
P19	0	0	0.167
P20	0	0	0.167
P21	0	0.083	0
P22	0	0.083	0
P23	0	0.083	0
P24	0	0.083	0
P25	0	0.083	0
P26	0	0.083	0
P27	0	0.083	0
P28	0	0.083	0
P29	0	0.083	0
P30	0	0.083	0
P31	0	0.083	0
P32	0	0.083	0

3.3. Industrial Feedback

In order to experiment with our approach, we used a known situation and modified different correctors so as to produce a defective part. Compared to a known situation, a difference of -0.1 on the length correction ($LC: -0.1$) has been added and a correction radius (RC) of equal value. *Figure 12* illustrates the measured deviation for each point.

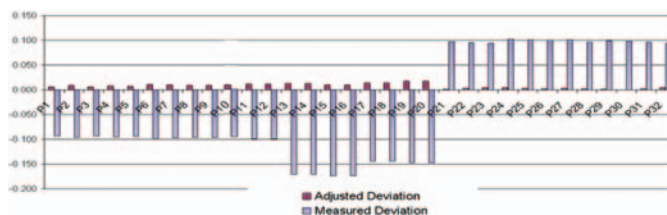

Figure 12. Result for $LC=-0.1$ and $RC = -0.1$

The measured deviation before the optimized adjustment (OA) is presented in blue. In red, we present the theoretical residual with the OA . The value of the AEI is equal to 83,9 %. *Table 3* presents the value of the corrector to adjust the deviation.

Table 3. Value of the corrector to adjust the measured deviation

	Corrector
LC	0.087
RC	0.098
LgC	-0.26

The measure of the adjusted part shows an AEI equal to 93.7%.

We can notice that the difference between the real AEI and the theoretical AEI is really sensitive to the variation in the process and the measurement machine. Consequently, some precautions must be taken to measure with effectiveness the real deviation effectively. Nevertheless, the result of this approach is really interesting because the optimized adjustment corrects 93% of the deviations of the part.

4. INDUSTRIAL CASE WITH FORM

This case corresponds to the machining of a part in its raw state.

4.1. Study Case

Figure 13 (a) shows the reference part built from the datum A , B and C . The shape is defined by a set of 11

points. Each measured point is calculated using the normal of the target surface. The geometry of the profile can be adjusted by two location correctors (DEC_1 , DEC_2), a rotation corrector (O_1) and a radius corrector (R_1). We note that O_1 corresponds to the rotation of the base where the part is located.

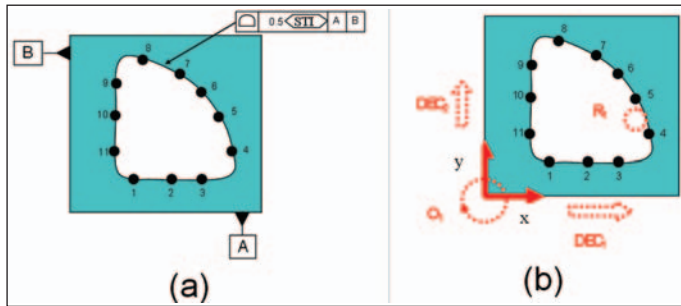

Figure 13. Part and Correctors (NF E 04 008, 2009)

4.2. Incidence matrix X

From the relations (7)(9)(10) and the coordinate of the 11 points, the incidence matrix X is defined. The dimension of the incidence matrix is composed of eleven lines and four columns which correspond to the number of measured points and the number of correctors in order to adjust the deviation of the vector E .

$$X = \begin{bmatrix} 0 & 1 & 1 & -3.5 \\ 0 & 1 & 1 & -6.75 \\ 0 & 1 & 1 & -10.65 \\ -0.98 & -0.17 & 1 & -1.62 \\ -0.86 & -0.5 & 1 & 0.73 \\ -0.71 & 0.71 & 1 & 0 \\ -0.5 & -0.86 & 1 & 0.73 \\ -0.17 & 0.95 & 1 & 1.62 \\ 1 & 0 & 1 & 10.65 \\ 1 & 0 & 1 & 6.75 \\ 1 & 0 & 1 & 3.5 \end{bmatrix} \quad (13)$$

The following table is the matrix X^* .

4.3. Industrial Feedback

From Table 4 and the relation (3), it is possible to deduce an adjust-

ment of the measured deviation as illustrated in Figure 14 (b). Figure 14 (a) shows the target shape and the measured shaped by dashed lines.

The inertia of the measured form (I_E : relation (6)) is equal to 1.03.

Therefore, it is important to adjust these deviations in order to respect the specification. The graph presented in Figure 14(b) corresponds to the absolute deviation for each point M_i .

From the deviation Figure 14(b), we obtain the values of adjustment (Table 5).

	Corrector
DEC_1	0.11
DEC_2	-0.22
R_1	0.29
O_1	0.19

Table 5. Value of the corrector to adjust the measured deviation

The proposed adjustment leads to an AEI equal to 97.67 %, thus an inertia of about 0.02.

The advantage of this approach is its rapidity. Indeed, when the incidence matrix is defined, the results are instant unlike a conventional adjustment which can last from between 10 minutes to 1 hour in function of the background of the machinist. In addition, this approach uses potentially more efficient corrector but which are not often not used by machine operators due to their complex impact on the measured points (eg rotate corrector, curvature corrector...). Consequently, the correctors with a complex impact can be used and thus increase the capacity of adjustment.

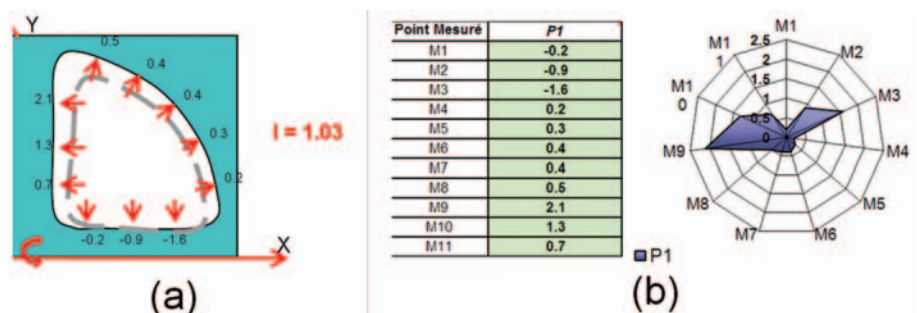

Figure 14. Defects on the measured Part

Table 4. Matrix X^*

	1	2	3	4	5	6	7	8	9	10	11
DEC_1	-0.23	-0	0.28	-0.41	-0.24	-0.1	0.06	0.259	-0.14	0.145	0.38
DEC_2	0.38	0.14	-0.14	0.26	0.06	-0.1	-0.24	-0.41	0.281	-0	-0.23
R_1	0.09	0.09	0.094	0.088	0.087	0.087	0.087	0.088	0.094	0.094	0.094
O_1	0.03	-0.01	-0.06	0.039	0.018	0	-0.02	-0.04	0.057	0.01	-0.03

5. CONCLUSIONS AND PERSPECTIVES

The first version of this method was developed using Excel[®]. However, several industrial cases constrained us to implement a program. Thus, we have solved a problem including that of a part defined by 3000 points and 9 correctors. The calculation time was less than 10 seconds. These experiments underline several prospects for improvement. This approach is recent, and the current perspectives are not exhaustive; Below, we suggest some of them:

- In this paper, we have presented an example with a procedure plan which is simple but: how do you adjust the part when the procedure plan is complex?
- The tool presented allows one to adjust all the deviations of a part. However, we can imagine that the surfaces which make up a part do not all

have the same requirements. So, for the same surface, the measured points will not have the same inertia. The question is: how can we solve this problem...? Our first thought, is to add weight on the surface. However, this solution remains to be validated.

- The second prospect is about the optimization criterion. Indeed, if we add a weight to differentiate the surfaces of a part. The solving by the Gauss criterion could not be efficient. In this case, what will it be the optimization criteria?
- The numerical model of part is an approximation. Indeed, the assembly of parts done with Computer Aided Design (CAD) software compared to an assembly of real parts (with the same dimensions as proposed by the CAD) presents some differences. In coming works, it will necessary to correct or take the numerical errors into account.

REFERENCES

- [1] **Duc E., Lartigue C., Tournier C., Bourdet P.**, A New Concept for the Design and the Manufacturing of Free-Form Surfaces: The Machining Surface, *Annals of the CIRP*, Vol. 48/1/1999.
- [2] **Li H and Feng HY**, Efficient five-axis machining of free-form surfaces with constant scallop height tool paths, *International Journal of Production Research*, Vol. 42, No. 12, 2004, pp. 2403-2417.
- [3] **Savio E., De Chiffre L., Schmitt R.**, Metrology of freeform shaped parts, *Annals of the CIRP*, Vol. 56/2/2007.
- [4] **Li, Y. and Gu, P.**, 2005. Sculptured surface tolerance verification with design datums, *International Journal of Production Research*, Vol. 43, No. 7, 1 April 2005, pp. 1465-1482.
- [5] **Jiang, X., Scott P. and Whitehouse D.**, Freeform surface characterisation – A Fresh Strategy, *Annals of the CIRP*, Vol. 56/1/2007.
- [6] **Yang M.Y. and SIM C.G.**, Reduction of machining errors by adjustment of federates in the ball-end milling process, *International Journal of Production Research*, Vol. 31, No. 3, 1993, pp. 665-689.
- [7] **Klocke, F., Kratz S., Veselovac E.D.**, Position-oriented process monitoring in freeform milling, *CIRP Journal of Manufacturing Science and Technology*; 1 (2008), pp. 103–107.
- [8] **Cho H.D., Jun, Y.T. and Yang, M.Y.**, Five-axis CNC milling for effective machining of sculptured surfaces, *International Journal of Production Research*, Vol. 31, No. 11, 1993, pp. 2559-2573.
- [9] **Thiebaut F., Latirgue C. and Duc E.**, A certification method for the milling process of free-form surfaces using a test part, *International Journal of Production Research*, Vol. 37, No. 2, 1999, pp. 315-327.
- [10] **Bouchenitfa, H.**, et al., 2009. Compensation relative deviations in the STL model using the FEM method: Application at the rapid prototyping technology. In: 11 th edition of the CIRP conference on Computer Aided Tolerancing 26-27 march 2009 Annecy. (France).
- [11] **Goldschmidt, E.**, 2009. *Gammes et cotation pour le réglage des machines outils de décolletage*, thesis (PhD) University of Savoie (France).
- [12] **Dubois, D.**, 2008. Rupture Adaptative», *TraMetal*, September 2008, p. 76.
- [13] **Desplat, C.**, 2008. L'usinage adaptatif pulvérise les rebuts, *Cetim infos*, June 2008, no. 203, pp. 22-25.
- [14] **Saporta, G.**, 2006. *Probabilités, Analyse des données et statistique*, 2 ed: Technip, Courbevoie.
- [15] **Nisbet, R.**, et al, 2009. Handbook of Statistical Analysis and Data Mining Applications, ed 1, Academic Press.
- [16] **Pillet. M.**, Inertial tolerancing, *The TQM Magazine*, Volume 16-Number 3-2004, pp. 202–209.
- [17] **Adragna, P.A.**, et al, 2007. Inertial tolerancing applied to 3D and form tolerancing with the modal analysis. In: 10 th edition of the CIRP conference on Computer Aided Tolerancing 21-23 march 2007 Erlangen.(Germany).
- [18] ISO 8015, Technical drawings — Fundamental tolerancing principle, ISO.
- [19] NF X E 04-008, Spécification géométrique des produits (GPS) – Calcul de tolérance, indications et critères d'acceptation – Méthodes arithmétique, statistique quadratique et statistique inertielle, AFNOR, Sept 2009.