



HAL
open science

Differential modulation of the cytokine-induced MMP-9/TIMP-1 protease-antiprotease system by the mTOR inhibitor rapamycin

Bashier Osman, El-Sayed Akool, Anke Doller, Roswitha Müller, Josef
Pfeilschifter, Wolfgang Eberhardt

► **To cite this version:**

Bashier Osman, El-Sayed Akool, Anke Doller, Roswitha Müller, Josef Pfeilschifter, et al.. Differential modulation of the cytokine-induced MMP-9/TIMP-1 protease-antiprotease system by the mTOR inhibitor rapamycin. *Biochemical Pharmacology*, 2010, 81 (1), pp.134. 10.1016/j.bcp.2010.09.011 . hal-00642428

HAL Id: hal-00642428

<https://hal.science/hal-00642428>

Submitted on 18 Nov 2011

HAL is a multi-disciplinary open access archive for the deposit and dissemination of scientific research documents, whether they are published or not. The documents may come from teaching and research institutions in France or abroad, or from public or private research centers.

L'archive ouverte pluridisciplinaire **HAL**, est destinée au dépôt et à la diffusion de documents scientifiques de niveau recherche, publiés ou non, émanant des établissements d'enseignement et de recherche français ou étrangers, des laboratoires publics ou privés.

Accepted Manuscript

Title: Differential modulation of the cytokine-induced MMP-9/TIMP-1 protease-antiprotease system by the mTOR inhibitor rapamycin

Authors: Bashier Osman, El-Sayed Akool, Anke Doller, Roswitha Müller, Josef Pfeilschifter, Wolfgang Eberhardt



PII: S0006-2952(10)00694-5
DOI: doi:10.1016/j.bcp.2010.09.011
Reference: BCP 10716

To appear in: *BCP*

Received date: 16-6-2010
Revised date: 9-9-2010
Accepted date: 10-9-2010

Please cite this article as: Osman B, Akool E-S, Doller A, Müller R, Pfeilschifter J, Eberhardt W, Differential modulation of the cytokine-induced MMP-9/TIMP-1 protease-antiprotease system by the mTOR inhibitor rapamycin, *Biochemical Pharmacology* (2010), doi:10.1016/j.bcp.2010.09.011

This is a PDF file of an unedited manuscript that has been accepted for publication. As a service to our customers we are providing this early version of the manuscript. The manuscript will undergo copyediting, typesetting, and review of the resulting proof before it is published in its final form. Please note that during the production process errors may be discovered which could affect the content, and all legal disclaimers that apply to the journal pertain.

ABSTRACT

1
2
3
4 The mTOR-inhibitor rapamycin is a potent drug used in many immunosuppressive and
5
6 antiinflammatory therapeutic regimes. In renal transplantation despite its beneficial roles
7
8 rapamycin in some cases can promote renal fibrosis in the kidney but the underlying
9
10 mechanisms are unknown. In this study, we tested for possible modulatory effects of
11
12 rapamycin on the cytokine-triggered matrix metalloproteinase 9 (MMP-9)/ tissue inhibitor of
13
14 metalloproteinase (TIMP)-1 protease-antiprotease system which is critically involved in renal
15
16 inflammation and fibrosis. Treatment of rat mesangial cells (MC) with rapamycin dose-
17
18 dependently reduced the interleukin 1 β (IL-1 β) -triggered increase in gelatinolytic levels as
19
20 demonstrated by zymography. The reduction in the extracellular MMP-9 content by
21
22 rapamycin coincided with an attenuation in cytokine-induced steady-state MMP-9 mRNA
23
24 levels. Conversely, rapamycin caused a dose-dependent increase in cytokine-evoked TIMP-1
25
26 expression in a Smad binding element (SBE) -dependent manner. Surprisingly, the attenuation
27
28 of MMP-9 mRNA levels by rapamycin is accompanied by a potentiation of IL-1 β - induced
29
30 MMP-9 promoter activity in which the stimulatory effects by rapamycin are mainly attributed
31
32 to a proximal AP-1 binding site. Furthermore, the rapamycin-dependent potentiation of MMP-
33
34 9 expression is accompanied by an amplification of cytokine-triggered activities of nuclear
35
36 factor κ B (NF- κ B) and activator protein 1 (AP-1) transcription factors. Importantly,
37
38 rapamycin-triggered increase in MMP-9 promoter activity is fully impaired when we used a
39
40 MMP-9 reporter construct which is under the additional control of the 3' untranslated region
41
42 (3'-UTR) of MMP-9. Collectively, these data imply that rapamycin inhibits the cytokine-
43
44 induced MMP-9 mainly through posttranscriptional events and thereby exerts profibrotic
45
46 activities.
47
48
49
50
51
52
53
54
55
56
57
58
59
60
61
62
63
64
65

1
2 **Keywords:** fibrosis, matrix metalloproteinase-9, rapamycin, transcription factors,
3
4
5 posttranscriptional gene regulation
6
7
8
9
10
11
12
13
14
15
16
17
18
19
20
21
22
23
24
25
26
27
28
29
30
31
32
33
34
35
36
37
38
39
40
41
42
43
44
45
46
47
48
49
50
51
52
53
54
55
56
57
58
59
60
61
62
63
64
65

Accepted Manuscript

1. Introduction

1
2
3
4
5 In order to avoid calcineurin inhibitor (CNI)-induced nephrotoxicity and the occurrence of
6
7 chronic nephropathy the macrocyclic lactone rapamycin (sirolimus) has firmly been
8
9 established as a potent immunosuppressive and antiinflammatory drug in CNI-free treatment
10
11 regimes [1,2]. In pharmacological terms, rapamycin acts through binding to the immunophilin
12
13 FK binding protein 12 (FKBP12) and thereby inhibits the activity of the mammalian target of
14
15 rapamycin (mTOR), a serine/threonine kinase which is critically involved in the regulation of
16
17 protein biosynthesis and cell cycle progression [1]. Although many studies demonstrated
18
19 potent antiinflammatory and antifibrotic effects of rapamycin, some recent studies have
20
21 additionally implicated a certain nephrotoxic potential of rapamycin especially when given in
22
23 combination with high doses of CNIs [3,4], similar to CNIs, activates fibrogenic Smad
24
25 signalling cascades via a direct and rapid activation of latent TGF β by a mechanism which
26
27 involves a generation of reactive oxygen species (ROS) [5]. Activation of Smad transcription
28
29 factors is concomitant with an expression of TGF β -controlled genes including fibrogenic
30
31 factors such as connective tissue growth factor (CTGF) and plasminogen activator inhibitor
32
33 (PAI-1) [5]. Tissue fibrosis is histologically characterized by an excessive extracellular matrix
34
35 (ECM) deposition [6,7]. Besides, the increased synthesis of ECM components, expansion of
36
37 ECM unequivocally may also result from an insufficient matrix turnover. Physiologically, the
38
39 degradation of ECM proteins is exerted by proteases including the matrix metalloproteases
40
41 (MMPs) and plasminogen, which inturn are controlled by the balance of plasminogen
42
43 activators (PAs) and plasminogen activator inhibitors (PAIs) and tissue inhibitors of matrix
44
45 metalloproteinases (TIMPs). Disturbances in ECM turnover are often caused by a reduction in
46
47 MMP expression and are worsened by an increased synthesis of the above mentioned intrinsic
48
49 protease inhibitors [8,9]. Many studies could demonstrate that IL-1 β is one of the major
50
51
52
53
54
55
56
57
58
59
60
61
62
63
64
65

1 inducer of MMP-9 [10-12]. In renal MC, the cytokine-induced expression of MMP-9, one of
2 the most abundant MMPs in the kidney, is transcriptionally inhibited by glucocorticoids and
3 cyclosporin A (CsA) mainly through a negative interference with the proinflammatory and
4 stress-inducible transcription factors activator protein-1 (AP-1) and nuclear factor κ B (NF- κ B)
5 [12,13]. Importantly, in rat MC corresponding binding sites located within a 1.3 kb upstream
6 promoter region are indispensable for transcriptional activation of MMP-9 by
7 proinflammatory cytokines [12,14]. The control of MMP-9 is complex since in addition to the
8 regulation of MMP-9 transcription and modulation of extracellular activity by TIMPs, MMP-9
9 is furthermore adjusted by posttranscriptional events namely by alterations in MMP-9 mRNA
10 stability [15,16] and/or changes in MMP-9 translation [17-20]. Structurally, AU-rich elements
11 (AREs) in the 3'untranslated region (3'-UTR) of the MMP-9 gene were reported as important
12 cis-regulatory elements for posttranscriptional regulation of MMP-9 expression [15,19]. With
13 respect to our previous finding demonstrating that rapamycin similarly to CNI, can promote
14 profibrogenic signalling in renal MC, we tested whether rapamycin would exert a similar
15 fibrogenic potential when added under proinflammatory conditions as simulated by the
16 stimulation of cells with interleukin 1 β (IL-1 β). Here, we demonstrate that the NF- κ B and
17 AP-1-triggered amplification of MMP-9 by rapamycin is counterbalanced and finally
18 dominated by inhibitory effects via the 3'-UTR of MMP-9 mRNA.
19
20
21
22
23
24
25
26
27
28
29
30
31
32
33
34
35
36
37
38
39
40
41
42
43
44
45
46
47
48
49
50
51
52
53
54
55
56
57
58
59
60
61
62
63
64
65

2. Materials and Methods

2.1. Cell culture and reagents

Rat glomerular MC were cultured as described [21]. Serum-free preincubations were performed in DMEM supplemented with 0.1 mg/ml of fatty acid-free bovine serum albumin (BSA) for 24 h before the cytokine was added. All cell culture media and supplements were purchased from Life-Technologies (Karlsruhe, Germany). For experiments $3.0\text{-}5.0 \times 10^6$ of MC per 10-cm culture dish were used between passages 12 and 19. Determination of cell numbers was done by use of a Neubauer chamber.

Human recombinant IL-1 β was from Cell Concept (Umkirch, Germany). Rapamycin and Actinomycin D (from *Streptomyces* species) were purchased from Calbiochem (Schwalbach, Germany). Antibodies against p65, HDAC-1, I κ B α as well as the anti-rabbit and anti-mouse horseradish peroxidase-linked IgGs were purchased from Santa Cruz Biotechnology (Heidelberg; Germany). Antibodies against phosphorylated (Ser 63) c-Jun, phosphorylated Smad 2, total c-Jun and total Smad 4 were obtained from Cell Signaling (Frankfurt am Main, Germany). The anti β -actin antibody was from Sigma-Aldrich (Deisenhofen, Germany). Radiochemicals were purchased from Perkin Elmer (Rodgau Jüdesheim, Germany); the ECL system and Hyperfilm were purchased from Amersham Pharmacia Biotech (Freiburg, Germany).

2.2. SDS-PAGE zymography

Assessment of gelatinolytic MMP-9 content of proteins from cellular supernatants was performed as described previously [22]. Proteins with gelatinolytic content were visualized as areas of lytic activity on an otherwise blue gel [23]. Migration properties of proteins were determined by comparison with that of prestained PageRulerTM protein ladder (MBI

1 Fermentas, St. Leon-Rot, Germany). Photographs of the gels were scanned by an imaging
2 densitometer system from Bio Rad Laboratories (München, Germany).
3
4
5
6

7 *2.3. Determination of TIMP-1 antigen levels in conditioned media*

8
9

10 Levels of TIMP-1 antigens in cell culture supernatants were quantified by the *Quantikine*
11 immunoassay kits from R&D Systems raised against rat TIMP-1 (Wiesbaden-Nordenstadt,
12 Germany). Confluent MC (1.0 to 1.5 x 10⁶ cells) on six-well plates were preincubated in
13 DMEM without FCS for 24 hours and stimulated with or without agents for the indicated time
14 periods. 20 µl of conditioned media were directly transferred to the microtest strip wells of the
15 ELISA plate. All further procedures were performed following the manufacturer's
16 instructions. The absorbances at 450 nm were measured in a microtest plate
17 spectrophotometer and antigen levels were determined by appropriate calibration curves.
18
19
20
21
22
23
24
25
26
27
28
29
30
31

32 *2.4. cDNA clones and plasmids*

33
34

35 cDNA inserts for rat MMP-9 and TIMP-1 were generated as described previously [22]. A
36 cDNA insert from mouse 18S rRNA was from Ambion (Austin, TX, USA). Cloning of a 1.3
37 kb fragment of the 5'-flanking region of the rat MMP-9 gene was described previously [12].
38 Introduction of double-point mutations into the NF-κB site of the pGL3-MMP-9 promoter
39 vector to generate pGL3-MMP-9ΔNK-κB as well as the mutation of either a proximal or a
40 distal lying AP-1 binding site to generate pGL3-MMP-9ΔAP-1/-87 or pGL3-MMP-9ΔAP-1/
41 504, respectively, was accomplished as described previously [12]. A 0.6 kb promoter
42 fragment of the rat wild-type TIMP-1 gene (pGL-3-TIMP-1) and mutated constructs bearing
43 a quadruple point mutation in a putative SBE (pGL-3-TIMP-1ΔSBE) are described by Akool
44 et al. [24]. The 3'-UTR sequence of the rat MMP-9 gene and a luciferase construct which in
45
46
47
48
49
50
51
52
53
54
55
56
57
58
59
60
61
62
63
64
65

1 addition to the 1.3 kb 5' promoter region of MMP-9 contains the 3'-UTR of the MMP-9 gene
2 (pGL3-MMP-9/3'-UTR) was generated as described previously [15].
3
4
5
6

7 8 *2.5. Reporter gene assays* 9

10 Transient transfections of MC were performed using the Effectene reagent (Quiagen, Hilden,
11 Germany). Transfections were performed following the manufacturer's instructions. The
12 transfections were done as triplicates and repeated at least three times to ensure reproducibility
13 of the results. Transfection with pRL-CMV coding for Renilla luciferase was used for control
14 of the transfection efficiency. Luciferase activities were measured with the dual reporter gene
15 system (Promega) using an automated chemoluminescence detector (Berthold, Bad Wildbad,
16 Germany).
17
18
19
20
21
22
23
24
25
26
27
28
29
30
31

32 *2.6. Northern blot analysis* 33

34 Total cellular RNA was extracted from MC using the Tri reagent (Sigma-Aldrich Chemie,
35 Taufkirchen, Germany) and RNA was hybridized following standard protocols as described
36 previously [22].
37
38
39
40
41
42
43

44 *2.7. Real-time RT-PCR* 45

46 Two-step real-time PCR was performed using a Taqman (ABI 7500) from Perkin Elmer. The
47 mRNA levels for MMP-9, elongation factor (EEF)-2 and GAPDH were determined by using a
48 protocol according to the "hot start" real-time PCR procedure with "Quanti-Tec" SYBR green
49 (Qiagen, Hilden, Germany). Total RNA was extracted using the Tri reagent and reverse
50 transcription was performed using 0.5 µg of total RNA and reverse transcriptase from
51 Invitrogen (Invitrogen, Karlsruhe, Germany) with random hexamer primers. The following
52 oligonucleotides were used for PCR:
53
54
55
56
57
58
59
60
61
62
63
64
65

1 MMP-9 forward: 5'-ACGTGGGCAAATTCCAAACCTT-3' ; MMP-9 reverse: 5'-
 2 AAGGCGTGTGCCAGTAGACCA-3'; EEF-2 forward: 5'-
 3 GACATCACCAAGGGTGTGCA-3'; EEF-2 reverse: 5'-GCGGTCAGCACACTGGCATA-
 4 3'; GAPDH forward: 5'-CACCATCTTCCAGGAGCGAG-3'and GAPDH reverse: 5'-
 5 GCAGGAGGCATTGCTGAT-3'. The C(T) values of MMP-9 mRNA levels were normalized
 6
 7 to the C(T) values of either GAPDH or EEF-2 mRNA within the same sample.
 8
 9
 10
 11
 12
 13
 14
 15
 16

17 2.8. Electrophoretic Mobility Shift Assay (EMSA)

18
 19 Preparation of crude nuclear extracts from cultured MC and subsequent EMSA was
 20 performed as described [14]. The sequences of the double-stranded oligonucleotides used for
 21 EMSA were derived from the rat MMP-9 promoter sequence (GenBank accession no. **AJ**
 22 **438266**) and were as follows:
 23
 24
 25
 26

27 NF- κ B (forward): 5'- TTGCCCCGTGGAATTCCCCCAAAT-3' (corresponding to a
 28 promoter region from -569 to -546) ;
 29
 30
 31
 32
 33

34 AP-1 (forward): 5'-CACACACCCTGAGTCAGCGTAAGCCTGGAGGG-3'(corresponding
 35 to a promoter region from -98 to -65). Binding reactions were performed for 45 min on ice
 36 with 5 μ g of protein in 20 μ l of binding buffer containing 4% Ficoll, 20 mM HEPES (pH 7.9),
 37 50 mM KCl, 1 mM EDTA, 1 mM DTT, 1 mM PMSF, 0.25 mg/ml BSA, 2 μ g of poly(dI-dC),
 38 and 30,000-50,000 cpm of 32 P-labeled oligonucleotide. The DNA-protein complexes were
 39 separated from unbound oligonucleotide by electrophoresis through native 5% polyacrylamide
 40 gels using 0.5 x Tris-borate-EDTA.
 41
 42
 43
 44
 45
 46
 47
 48
 49
 50
 51
 52

53 For supershift analysis, 2 μ l of supershift antibody was preincubated for 1 hour at room
 54 temperature with the nuclear extracts before the radioactively labeled oligonucleotide was
 55 added to the binding reaction.
 56
 57
 58
 59
 60
 61
 62
 63
 64
 65

2.9. Western blot analysis

1
2 For detection of phosphorylated and total JNK whole cell lysates were prepared as described
3
4 previously [12]. Western blot analysis was performed by standard procedures. 50 µg of crude
5
6 nuclear cell extracts were used for the assessment of nuclear import of p65-NF-κB.
7
8
9
10 Cytoplasmic levels of IκB were analyzed using 50-100 µg of total protein from the
11
12 corresponding cytoplasmic fractions. To ensure an equal sample loading of nuclear proteins
13
14 the blots were stained with Ponceau-S.
15
16
17
18
19
20

2.10. Statistical analysis

21
22 Results are expressed as means ± SD. Statistical analysis was performed using the Student's t-
23
24 test and the analysis of variance (ANOVA) test for significance. The data are presented as
25
26 relative induction compared to control conditions (*) or compared to IL-1β-stimulated values
27
28
29 (#). P values ≤ 0.05 (*) (#), ≤ 0.01(**) (##), and ≤ 0.001 (***) (###) were considered
30
31
32
33
34 significant.
35
36
37
38
39
40
41
42
43
44
45
46
47
48
49
50
51
52
53
54
55
56
57
58
59
60
61
62
63
64
65

3. Results

3.1. Rapamycin reduces the cytokine-induced activity and mRNA steady-state level of MMP-9

Previously, we demonstrated that the immunosuppressive drug CsA, in contrast to tacrolimus (FK506), inhibits the cytokine-induced expression of MMP-9 in renal MC [13]. Here, we tested whether the mTOR kinase inhibitor rapamycin, another immunosuppressant with an overall lower nephrotoxic potential than CNIs, exerts a similar modulatory effect on MMP-9. Although rapamycin binds to the the same intracellular receptor as tacrolimus, i.e. the FKBP12, its immunosuppressive action is not mediated by an inhibition of calcineurin [1]. To evaluate possible modulatory effects of rapamycin on the extracellular activity of MMP-9, MC were treated with IL-1 β (2nM) for 24 hours in the presence of different concentrations of rapamycin (Fig. 1A). The gelatinolytic content of conditioned media was tested by zymography using gelatin as a substrate. As depicted in Fig. 1A, supernatants of MC under stimulatory conditions contain MMP-2 and MMP-9 with their characteristic migration properties at 68, 72 kDa (MMP-2) and 92 kDa (MMP-9), respectively. Rapamycin dose-dependently attenuated the extracellular IL-1 β -evoked MMP-9 levels with a maximal reduction seen at 100 ng/ml, whereas it had no effect on the constitutive levels of latent and active MMP-2, represented by the two lytic bands at 68 and 72 kDa, respectively (Fig. 1A). To further investigate whether the reduction in the lytic content of MMP-9 by rapamycin is due to a reduction in the corresponding MMP-9 mRNA levels, we performed Northern blot analysis using a cDNA probe from the rat MMP-9 gene [22]. Again, MC were stimulated for 24 hours with IL-1 β (2nM) in the presence of different concentrations of rapamycin as indicated in Fig. 1B. Concomitantly with the inhibitory effect on gelatinolytic MMP-9 content, rapamycin dose-dependently attenuated the IL-1 β -induced MMP-9 mRNA level and a maximal inhibition of approximately 60% was obtained when rapamycin was used at 100

1 ng/ml (Fig. 1B). Again, rapamycin was unable to induce MMP-9 mRNA when given alone
2 (Fig. 1B). These data indicate that alterations in the cytokine-induced extracellular MMP-9
3 content by rapamycin predominantly result from reduced steady-state MMP-9 mRNA levels.
4
5
6
7
8
9

10 3.2. Rapamycin induces the expression of TIMP-1

11 In a next step, we evaluated whether rapamycin, in addition to MMP-9, could influence the
12 cytokine-induced levels of the intrinsic MMP-9 inhibitor TIMP-1. To this end, MC were
13 stimulated with either IL-1 β (2nM), in the absence or presence of rapamycin and
14 corresponding cell supernatants were collected after 4, 8 and 24 hours for assessment of
15 extracellular TIMP-1 antigen levels by specific ELISA. Treatment of MC with either IL-1 β or
16 with rapamycin caused a significant increase in the amount of extracellular TIMP-1 at 8 and
17 24 hours of stimulation (Fig. 2A). The combination of both stimuli resulted in an additive
18 increase in TIMP-1 release and was most prominently seen at 24 hours of stimulation (Fig.
19 2A). In order to test whether alterations in extracellular TIMP-1 contents by rapamycin were
20 attributed to changes in TIMP-1 mRNA levels, we performed Northern blot analysis by using
21 a cDNA probe from the rat TIMP-1 gene [22]. Since the stimulatory effects of rapamycin
22 were most obvious after 24h, we chose this incubation time for an assessment of steady-state
23 TIMP-1 mRNA levels. As shown in Fig. 2B, rapamycin dose-dependently enhanced the IL-
24 1 β -induced steady-state TIMP-1 mRNA levels and caused a parallel increase in extracellular
25 TIMP-1. Rapamycin caused a moderate increase in basal TIMP-1 mRNA levels when given
26 alone. In a next approach, we assessed whether the rapamycin-mediated increase in cytokine-
27 induced TIMP-1 mRNA levels rely on transcriptional events. For this purpose we tested the
28 inducibility of a reporter construct bearing 0.6 kb of an upstream promoter region of the rat
29 TIMP-1 gene [24]. Transient transfection of MC with pGL-TIMP-1 was followed by a 24
30 hour treatment with IL-1 β (2nM) in the absence or presence of rapamycin before cells were
31
32
33
34
35
36
37
38
39
40
41
42
43
44
45
46
47
48
49
50
51
52
53
54
55
56
57
58
59
60
61
62
63
64
65

1
2
3
4
5
6
7
8
9
10
11
12
13
14
15
16
17
18
19
20
21
22
23
24
25
26
27
28
29
30
31
32
33
34
35
36
37
38
39
40
41
42
43
44
45
46
47
48
49
50
51
52
53
54
55
56
57
58
59
60
61
62
63
64
65

lysed for assessment of luciferase activity. As shown in Fig. 2C, stimulation with either IL-1 β or rapamycin caused a weak increase in TIMP-1 promoter activity and further increased in an additive manner when both stimuli were applied in combination (Fig. 2C, upper panel). These data are reminiscent of the regulation of another protease inhibitor, plasminogen activator inhibitor-1 (PAI-1) by rapamycin involving the TGF β -Smad signaling cascade [5].

Therefore, we tested for an activation of the Smad signaling cascade by assessment of nuclear Smad 2 and Smad 4. Importantly, IL-1 β alone caused a moderate increase in phospho-Smad 2 levels and this increase was dose-dependently augmented by rapamycin. Concomitantly, nuclear Smad 4 contents was dose-dependently increased by rapamycin (Fig. 2C, lower panel).

To additionally test whether the activation of Smads plays a functional role in TIMP-1 regulation, we tested whether induction of TIMP-1 promoter activity by rapamycin depends on a functional Smad-binding element (SBE). To this end, the inducibility of a TIMP-1 promoter construct (pGL-3-TIMP Δ SBE) bearing a point mutation in SBE was assessed [24]. As shown in Fig. 2D, mutation of SBE completely impaired promoter inducibility by rapamycin (black bars) thus supporting the notion that the rapamycin-triggered induction of TIMP-1 occurs via activation of Smads and their binding to a corresponding promoter element.

3.3. Rapamycin amplifies the cytokine-induced activity of p65 and c-Jun

Previously, we have demonstrated that the inhibition of MMP-9 by cyclosporin A is mainly attributable to an inhibition of the proinflammatory transcription factors NF- κ B and AP-1 [13]. To test for a possible involvement of either transcription factor in the rapamycin-mediated suppression of MMP-9, we assessed nuclear extracts from stimulated MC for NF- κ B and AP-1 activities. We monitored nuclear translocation of the NF- κ B subunit p65 and

1 phosphorylation of nuclear c-Jun by Western blot analysis, since both events are indicative for
2 an activation of the transcription factors. We chose a short stimulation of 30 min as the
3
4 activation of both factors by cytokines achieved a maximal response at this time point [13].
5
6 Stimulation of MC with IL-1 β was followed by a clear increase in phospho-c-Jun levels and
7
8 surprisingly, the cytokine-evoked increase in phosphorylated c-Jun was further amplified with
9
10 increasing doses of rapamycin without any effect on basal phospho-c-Jun levels (Fig. 3A). By
11
12 contrast, the nuclear content of c-Jun remained constant independently of the stimulus applied
13
14 (Fig. 3A). In parallel to the increase in nuclear c-Jun phosphorylation, rapamycin caused a
15
16 dose-dependent augmentation of the nuclear p65 import triggered by IL-1 β but had only a
17
18 moderate stimulatory effect on nuclear p65 translocation when given alone (Fig. 3A).
19
20 Corresponding to the increased nuclear import of p65, the cytoplasmic degradation of the
21
22 inhibitor of κ B (I κ B) achieved by IL-1 β was dose-dependently intensified by rapamycin
23
24 resulting in a complete disappearance of I κ B at the highest does of rapamycin tested (100
25
26 ng/ml) (Fig. 3A, lower panel).
27
28
29
30
31
32
33

34
35 Consistently, EMSA with a gene-specific NF- κ B oligonucleotide demonstrated that
36
37 rapamycin caused an amplification of the cytokine-evoked binding affinity of a slow-
38
39 migrating and IL-1 β -inducible complex (Fig. 3B, upper left panel) which mainly consists of
40
41 p65 as demonstrated by supershift analysis (Fig. 3B, upper right panel). The amplification of
42
43 NF- κ B binding affinity by rapamycin was most clearly seen in those experiments with a
44
45 moderate NF- κ B induction (Fig. 3B, upper panel) indicating that rapamycin mainly acts via an
46
47 amplification of cytokine-evoked NF- κ B signalling.
48
49
50
51
52

53
54 In contrast to NF- κ B, the constitutive DNA-binding to a proximal AP-1 site at -87/-81 was
55
56 not affected by IL-1 β , but was intensified by rapamycin (Fig. 3B, lower left panel). Supershift
57
58 analysis showed that the rapamycin sensitive complex mainly consists of c-Jun (Fig. 3B,
59
60 lower right panel) which is consistent with results from Western blot analysis (Fig. 3A.)
61
62
63
64
65

1 Taken together, these results indicate that rapamycin contrary to its well established
2 antiinflammatory properties and in a contrast to CsA, amplifies the cytokine-induced activities
3 of NF- κ B and AP-1 transcription factors.
4
5
6
7
8
9

10 3.4. Rapamycin amplifies IL-1 β -triggered MMP-9 promoter activity via AP-1 and NF- κ B

11 To further investigate whether the inhibition of cytokine-induced MMP-9 mRNA levels by
12 rapamycin is reflected by an inhibition in MMP-9 promoter activity, we performed reporter
13 gene assays using a 1.3 kb MMP-9 promoter fragment (“pGL3-MMP-9”, Fig. 4A). This
14 promoter portion is sufficient for the induction of MMP-9 by IL-1 β and critically depends on
15 AP-1 and NF- κ B binding sites [12]. Transient transfection of MC with pGL3-MMP-9 was
16 followed by a 24h treatment with IL-1 β (2nM), rapamycin (100ng/ml) or both in combination
17 and subsequently, cells were assayed for luciferase activity. Similar to the amplification of
18 AP-1 and NF- κ B binding, the IL-1 β -induced increase in MMP-9 promoter activity was
19 significantly amplified by rapamycin (Fig. 4B “pGL3-MMP-9”). In addition, rapamycin
20 significantly increased MMP-9 promoter activity when given alone (Fig. 4B). Based on our
21 previous finding that AP-1 and NF- κ B promoter elements are indispensable for MMP-9
22 promoter activation by IL-1 β , we furthermore tested for a functional role of corresponding
23 promoter elements in the amplification of MMP-9 promoter activity by rapamycin. To this
24 end, we assayed the luciferase activities of pGL3-MMP-9 constructs bearing single point
25 mutations in the binding sites of NF- κ B or AP-1 as depicted in Fig. 4A.
26
27
28
29
30
31
32
33
34
35
36
37
38
39
40
41
42
43
44
45
46
47
48
49

50 In a full agreement with our previous findings [12], mutation of either the NF- κ B binding site
51 (pGL-3-MMP-9 Δ NF- κ B) or of a distal AP-1 site (pGL3-MMP-9 Δ AP-1/-504) prevented the
52 cytokine induction of pGL-MMP-9 by IL-1 β and impaired the stimulatory effect by rapamycin
53 (Fig. 4B). These data suggest that both transcription factor binding sites are indispensable for
54 induction of MMP-9 promoter activity by IL-1 β . Most intriguingly, a mutation of the
55
56
57
58
59
60
61
62
63
64
65

1 proximal AP-1 site at -87 (pGL3-MMP-9 Δ AP-1/-87) specifically prevented MMP-9 promoter
2 activation by rapamycin but did not interfere with IL-1 β inducibility (Fig. 4C). This also fits
3 to the AP-1 EMSA performed with a probe encompassing the corresponding promoter region
4 (Fig. 3B, lower panels) and corroborates that the proximal AP-1 binding site at -87 is mainly
5 involved in the amplification of MMP-9 promoter activity by rapamycin but irrelevant for
6 cytokine induction of MMP-9.
7
8
9
10
11
12
13

14 3.5. Rapamycin-triggered amplification of MMP-9 is prevented in the presence of the 3'-UTR

15
16
17
18
19
20 The discrepant findings from Northern blot analysis and reporter gene assays imply that
21 rapamycin may mask the positive effects on MMP-9 transcription and actually inhibit MMP-9
22 expression via additional posttranscriptional mechanisms. Negative effects on mRNA stability
23 by rapamycin have been reported for the IL-3 mRNA [25]. Importantly, we previously
24 demonstrated that the rat MMP-9 is regulated via changes in mRNA stability [15]. In order to
25 test whether rapamycin may affect the stability of MMP-9 mRNA, we performed actinomycin
26 D experiments. MC were stimulated for 24 hours with IL-1 β (2 nM) before transcription was
27 blocked by actinomycin D (5 μ g/ml). Subsequently, cells were treated in the presence or
28 absence of rapamycin (100 ng/ml) for further 12 or 24 hours, respectively. MMP-9 mRNA
29 levels showed an approximate 50% reduction at 12 hours but, importantly, rapamycin had no
30 significant modulatory effect on the decay of MMP-9 mRNA (Fig. 5A). Unfortunately,
31 coincubations with actinomycin-D and rapamycin longer than 12 hours resulted in a strong
32 cell death which probably is due to a simultaneous inhibition of transcription and translation
33 (data not shown). In addition, actinomycin D is known to affect nucleo-cytoplasmic HuR
34 shuttling and thereby might also influence the stability of MMP-9 mRNA in renal MC.
35 Therefore, as an alternative approach, we chose a Luciferase reporter construct which in
36 addition to the 5' promoter region is under the control of the 3'-UTR of the MMP-9 gene
37
38
39
40
41
42
43
44
45
46
47
48
49
50
51
52
53
54
55
56
57
58
59
60
61
62
63
64
65

1 (“pGL3-MMP-9/3'-UTR”) as indicated in Fig. 5B. We and others have demonstrated that
2 regulatory sequences within the 3'-UTR are functionally relevant for posttranscriptional
3 control of MMP-9 [15,19]. Indeed, transient transfection of MC with this reporter construct
4 revealed that the stimulatory effects of rapamycin shown in Fig. 4B were totally abrogated
5 when the reporter was under the additional control of the 3'-UTR of MMP-9 (Fig. 5B). These
6 results document that the inducible effects on cytokine-triggered MMP-9 expression by
7 rapamycin are blunted in the presence of the 3'-UTR of the MMP-9 gene.
8
9
10
11
12
13
14
15
16
17
18
19
20
21
22
23
24
25
26
27
28
29
30
31
32
33
34
35
36
37
38
39
40
41
42
43
44
45
46
47
48
49
50
51
52
53
54
55
56
57
58
59
60
61
62
63
64
65

4. Discussion

1
2 In this report, we provide evidence that the immunosuppressive drug rapamycin potently
3 inhibits cytokine-induced expression and activity of MMP-9 through different mechanisms.
4

5
6 On the one hand, we demonstrate that rapamycin amplifies the cytokine-induced extracellular
7 content of TIMP-1, the intrinsic inhibitor of MMP-9, via a drug-dependent activation of
8 TIMP-1 promoter activity involving a Smad binding element (SBE) (Fig. 2C). On the other
9 hand, we observed a significant reduction in the steady-state MMP-9 mRNA levels by
10 rapamycin accompanied by a dose-dependent attenuation in MMP-9 gelatinolytic levels (Fig.
11 1). However, contrary to the reduction of cytokine-induced MMP-9 expression, reporter gene
12 assays with a 1.3 kb MMP-9 promoter construct revealed a potentiation in cytokine-induced
13 promoter activity. The latter amplification is attributable to a proximal AP-1 binding site (Fig.
14 4C). Consistent with the rapamycin-triggered increase in MMP-9 promoter activity, we
15 observed a dose-dependent potentiation of the cytokine-evoked transcription factors c-Jun and
16 NF- κ B by rapamycin (Fig. 3). These data implicate that the transcription factors which are
17 indispensably required for MMP-9 transcription [12,26] are also targeted by rapamycin (Fig.
18 4). In line with this observation, previous studies have demonstrated that mTOR inhibition by
19 rapamycin via activation of the c-Jun N-terminal kinase (JNK) induces a rapid c-Jun
20 phosphorylation which in turn is functionally implicated in p53-independent apoptosis [27]
21 and in the transcriptional upregulation of MMP-1 [28].
22
23
24
25
26
27
28
29
30
31
32
33
34
35
36
37
38
39
40
41
42
43
44
45
46

47 The elevation in MMP-9 promoter activity and the corresponding AP-1 and NF- κ B activities
48 by rapamycin contrast to the negative effects we have observed with CsA [13]. According to
49 the regulatory role of JNK in activating AP-1 it is tempting to speculate that a differential
50 modulation of JNK by CsA and rapamycin is causally involved in their opposing effects on
51 proinflammatory transcription factors and MMP-9 promoter activity. In addition, our data
52 implicate that the antiinflammatory activities reported for rapamycin are not attributed to an
53
54
55
56
57
58
59
60
61
62
63
64
65

1 inhibition of AP-1 and NF- κ B. Moreover, our data exclude that the negative regulation of
2
3 MMP-9 gene expression by rapamycin is caused by induction of the TGF β /Smad cascade as
4
5 has been demonstrated for the human MMP-9 gene [29]. The question whether regulatory
6
7 promoter elements upstream of -13 kb of the MMP-9 gene are negatively influenced by
8
9 rapamycin is a subject of ongoing research in our laboratory. In view of the contradictory
10
11 effects of rapamycin on MMP-9 mRNA levels and MMP-9 promoter activity, we postulated
12
13 that the negative effects on MMP-9 by rapamycin may result from additional
14
15 posttranscriptional events. Notably, we previously could demonstrate that several copies of
16
17 destabilizing AU-rich elements (AREs) present in the 3'-UTR of rat MMP-9 gene are
18
19 critically involved in the posttranscriptional regulation of MMP-9 [15,30,31].
20
21
22
23

24
25 The functional relevance of the 3'-UTR in rapamycin dependent MMP-9 regulation is provided
26
27 by the finding that stimulatory effects on MMP-9 promoter activity by rapamycin were fully
28
29 impaired when the MMP-9 reporter gene was under the additional control of the 3'-UTR of
30
31 MMP-9 (Fig. 5B).
32
33

34
35 In line with our observations a posttranscriptional regulation by rapamycin has been
36
37 convincingly demonstrated for IL-3 mRNA [25]. Despite of the IL-3 encoding mRNA,
38
39 destabilizing effects by rapamycin have furthermore been described for other mRNAs
40
41 including those coding for collagen type 1 [32] and collagen type 3A1 [28] as well as cyclin
42
43 D₃ mRNA [30]. Similar to IL-3 mRNA, the destabilizing effect of rapamycin on cyclin D₃
44
45 mRNA is attributed to two canonical AREs in the 3'-UTR of an mRNA [33].
46
47
48

49
50 Our finding that the blockade of transcription by actinomycin D experiments showed no
51
52 changes in MMP-9 mRNA decay implies that rapamycin may act via the induction of mRNA
53
54 destabilizing factor (Fig. 5A). Prominent candidates for mRNA binding proteins with a
55
56 predominantly destabilizing effect on ARE-mRNAs are polyA/poly U-binding degradation
57
58 factor (AUF) [34], tristetraprolin (TTP) [35] and the K-homology-type splicing regulatory
59
60
61
62
63
64
65

1 protein (KSRP) [36]. Further studies are needed to test whether the expression of one of these
2 factors is modulated by rapamycin. Alternatively, rapamycin may induce the expression of a
3 miRNA which specifically targets MMP-9 mRNA. However, to the best of our knowledge, a
4 contribution of miRNAs in the suppression of MMP-9 expression has not been described so
5 far.
6
7
8
9
10

11 Functionally, the inhibition in collagen I expression by rapamycin may counteract an
12 accumulation of extracellular matrix and thus counteract tissue fibrosis [28]. In contrast to
13 these antifibrotic activities, we previously found that rapamycin via rapid induction of the
14 canonical TGF β -Smad signalling cascade promotes profibrotic gene expression in rat MC [5].
15 The finding that rapamycin, in addition to induction of TIMP-1, directly interferes with the
16 expression of MMP-9 further underscores the profibrotic potential by its activation of the
17 canonical TGF β -Smad signaling pathway [5]. Unlike tissue fibrosis, an excessive degradation
18 of ECM as a result of increased expression of matrix-metabolizing proteases is a hallmark of
19 many inflammatory processes and functionally relevant for irreversible alterations of tissue
20 architecture. In the kidney, apart from the general role in ECM remodelling, an excessive
21 proteolytic degradation of collagen IV-containing basement membranes mainly by MMP-9,
22 seems an important feature for the increased recruitment of monocytes and macrophages to the
23 site of inflammation [6]. Proinflammatory cytokines such as TNF- α and IL-1 β either
24 produced by infiltrating immune cells, or by resident activated glomerular MC are among the
25 most potent inducers of MMP-9 [12,22]. Besides its potent immunosuppressive and
26 antiproliferative properties via mTOR kinase inhibition, the attenuation of cytokine-evoked
27 MMP-9 by rapamycin may additionally contribute to its anti-inflammatory and profibrotic
28 activities [28,37]. Whether the rapamycin-mediated suppression of MMP-9 like the one
29 evoked by CsA is independent of its primary immunosuppressive action needs further
30 investigations.
31
32
33
34
35
36
37
38
39
40
41
42
43
44
45
46
47
48
49
50
51
52
53
54
55
56
57
58
59
60
61
62
63
64
65

1
2
3
4
5
6
7
8
9
10
11
12
13
14
15
16
17
18
19
20
21
22
23
24
25
26
27
28
29
30
31
32
33
34
35
36
37
38
39
40
41
42
43
44
45
46
47
48
49
50
51
52
53
54
55
56
57
58
59
60
61
62
63
64
65

In summary, our study shows that the immunosuppressant rapamycin amplifies cytokine-induced NF- κ B and AP-1 activation and subsequently on MMP-9 promoter activity. However, this response is counteracted by an inhibitory effect of rapamycin on the IL-1 β -induced MMP-9 mRNA stability by targeting destabilizing elements in the 3'-UTR of MMP-9 mRNA. Our study furthermore highlights the complex repertoire of regulatory events which in addition to mTOR inhibition are executed by rapamycin.

Acknowledgements

The authors acknowledge the financial support of grants from the Deutsche Forschungsgemeinschaft EB 257/3-1, EB 257/5-1, GRK1172 and EXC 147/1.

References

- 1
2
3
4 [1] Faivre S, Kroemer G, Raymond E. Current development of mTOR inhibitors as
5 anticancer agents. *Nat Rev Drug Discov* 2006;5:671-88.
6
7 [2] Saunders RN, Metcalfe MS, Nicholson ML. Rapamycin in transplantation: a review of
8 the evidence. *Kidney Int* 2001;59:3-16.
9
10 [3] Shihab FS, Bennett WM, Yi H, Choi SO, Andoh TF. Sirolimus increases transforming
11 growth factor-beta1 expression and potentiates chronic cyclosporine nephrotoxicity.
12 *Kidney Int* 2004;65:1262-71.
13
14 [4] Ninova D, Covarrubias M, Rea DJ, Park WD, Grande JP, Stegall MD. Acute
15 nephrotoxicity of tacrolimus and sirolimus in renal isografts: differential intragraft
16 expression of transforming growth factor- β 1 and α -smooth muscle actin.
17 *Transplantation* 2004;78:338-44.
18
19 [5] Osman B, Doller A, Akool el-S, Holdener M, Hintermann E, Pfeilschifter J et al.
20 Rapamycin induces the TGF β 1/Smad signaling cascade in renal mesangial cells
21 upstream of mTOR. *Cell Signal* 2009;21:1806-17.
22
23 [6] Eddy AA. Molecular insights into renal interstitial fibrosis. *J Am Soc Nephrol* 1996; 7:2495-
24 508
25
26 [7] Eddy AA, Fogo AB. Plasminogen activator inhibitor-1 in chronic kidney disease:
27 evidence and mechanisms of action. *J Am Soc Nephrol* 2006;17:2999-12.
28
29 [8] Nagase H, Woessner JF Jr. Matrix metalloproteinases. *J Biol Chem* 1999;274:21491-4.
30
31 [9] Lenz O, Elliot SJ, Stetler-Stevenson WG. Matrix metalloproteinases in renal
32 development and disease. *Am Soc Nephrol* 2000;11:574-81.
33
34 [10] Van Ranst M, Norga K, Masure S, Proost P, Vandekerckhove F, Auwerx J, Van
35 Damme J, Opdenakker G. The cytokine-protease connection: identification of a 96-kD
36 THP-1 gelatinase and regulation by interleukin-1 and cytokine inducers. *Cytokine*
37 1991;3:231-9.
38
39 [11] Opdenakker G, Masure S, Grillet B, Van Damme J. Cytokine-mediated regulation of
40 human leukocyte gelatinases and role in arthritis. *Lymphokine Cytokine Res*
41 1991;10:317-24.
42
43 [12] Eberhardt W, Schulze M, Engels C, Klasmeier E, Pfeilschifter J. Glucocorticoid-
44 mediated suppression of cytokine-induced matrix metalloproteinase-9 expression in rat
45 mesangial cells: involvement of nuclear factor- κ B and Ets transcription factors. *Mol*
46 *Endocrinol* 2002;16:1752-66.
47
48
49
50
51
52
53
54
55
56
57
58
59
60
61
62
63
64
65

- 1 [13] Doller A, Akool el-S, Müller R, Gutwein P, Kurowski C, Pfeilschifter J et al. Molecular
2 mechanisms of cyclosporin A inhibition of the cytokine-induced matrix
3 metalloproteinase-9 in glomerular mesangial cells. *J Am Soc Nephrol* 2007;18:581-92.
4
- 5 [14] Eberhardt W, Huwiler A, Beck KF, Walpen S, Pfeilschifter J. Amplification of IL-1 β -
6 induced matrix metalloproteinase-9 expression by superoxide in rat glomerular
7 mesangial cells is mediated by increased activities of NF- κ B and activating protein-1
8 and involves activation of the mitogen-activated protein kinase pathways. *J Immunol*
9 2000;165:5788-7.
10
- 11 [15] Akool el-S, Kleinert H, Hamada FM, Abdelwahab MH, Förstermann U, Pfeilschifter J
12 et al. Nitric oxide increases the decay of matrix metalloproteinase 9 mRNA by
13 inhibiting the expression of mRNA-stabilizing factor HuR. *Mol Cell Biol*
14 2003;23:4901-16.
15
- 16 [16] Iyer V, Pumiglia K, DiPersio CM. Alpha3beta1 integrin regulates MMP-9 mRNA
17 stability in immortalized keratinocytes: a novel mechanism of integrin-mediated MMP
18 gene expression. *J Cell Sci* 2005;118:1185-95.
19
- 20 [17] Jiang Y, Muschel RJ. Regulation of matrix metalloproteinase-9 (MMP-9) by
21 translational efficiency in murine prostate carcinoma cells. *Cancer Res* 2002;62:1910-4.
22
- 23 [18] Sehgal I, Thompson TC. Novel regulation of type IV collagenase (matrix
24 metalloproteinase-9 and -2) activities by transforming growth factor- β 1 in human
25 prostate cancer cell lines. *Mol Biol Cell* 1999;10:407-16.
26
- 27 [19] Föhling M, Steege A, Perlewitz A, Nafz B, Mrowka R, Persson PB et al. Role of
28 nucleolin in posttranscriptional control of MMP-9 expression. *Biochim Biophys Acta*
29 2005;1731:32-40.
30
- 31 [20] Jespersen C, Doller A, Akool el-S, Bachmann M, Müller R, Gutwein P, et al.
32 Molecular mechanisms of nitric oxide-dependent inhibition of TPA-induced matrix
33 metalloproteinase-9 (MMP-9) in MCF-7 cells. *J Cell Physiol* 2009;219:276-87.
34
- 35 [21] Pfeilschifter J, Vosbeck K. Transforming growth factor β 2 inhibits interleukin 1 β - and
36 tumour necrosis factor α induction of nitric oxide synthase in rat renal mesangial cells.
37 *Biochem Biophys Res Commun* 1991;175:372-9.
38
- 39 [22] Eberhardt W, Beeg T, Beck KF, Walpen S, Gauer S, Böhles H et al. Nitric oxide
40 modulates expression of matrix metalloproteinase-9 in rat mesangial cells. *Kidney Int*
41 2000;57:59-69.
42
- 43 [23] Van den Steen PE, Dubois B, Nelissen I, Rudd PM, Dwek RA, Opdenakker G.
44 Biochemistry and molecular biology of gelatinase B or matrix metalloproteinase-9
45 (MMP-9). *Crit Rev Biochem Mol Biol* 2002;37:375-536.
46
47
48
49
50
51
52
53
54
55
56
57
58
59
60
61
62
63
64
65

- 1 [24] Akool el-S, Doller A, Müller R, Gutwein P, Xin C, Huwiler A et al. Nitric oxide
2 induces TIMP-1 expression by activating the transforming growth factor beta-Smad
3 signaling pathway. *J Biol Chem* 2005;280:39403-16.
- 4 [25] Banholzer R, Nair AP, Hirsch HH, Ming XF, Moroni C. Rapamycin destabilizes
5 interleukin-3 mRNA in autocrine tumor cells by a mechanism requiring an intact 3'
6 untranslated region. *Mol Cell Biol* 1997;17:3254-60.
- 7 [26] Yokoo T, Kitamura M. Dual regulation of IL-1 β -mediated matrix metalloproteinase-9
8 expression in mesangial cells by NF-kappa B and AP-1. *Am J Physiol* 1996;270:F123-
9 30.
- 10 [27] Huang S, Shu L, Dilling MB, Easton J, Harwood FC, Ichijo H et al. Sustained activation
11 of the JNK cascade and rapamycin-induced apoptosis are suppressed by p53/p21(Cip1).
12 *Mol Cell* 2003;11:1491-01.
- 13 [28] Poulalhon N, Farge D, Roos N, Tacheau C, Neuzillet C, Michel L et al. Modulation of
14 collagen and MMP-1 gene expression in fibroblasts by the immunosuppressive drug
15 rapamycin. A direct role as an antifibrotic agent? *J Biol Chem* 2006;281:33045-52.
- 16 [29] Ogawa K, Chen F, Kuang C, Chen Y. Suppression of matrix metalloproteinase-9
17 transcription by transforming growth factor- β is mediated by a nuclear factor- κ B site.
18 *Biochem J* 2004;381:413-22.
- 19 [30] Huwiler A, Akool el-S, Aschrafi A, Hamada FM, Pfeilschifter J, Eberhardt W. ATP
20 potentiates interleukin-1 beta-induced MMP-9 expression in mesangial cells via
21 recruitment of the ELAV protein HuR. *J Biol Chem* 2003;278: 51758-69.
- 22 [31] Eberhardt W, Doller A, Akool el-S, Pfeilschifter J. Modulation of mRNA stability as a
23 novel therapeutic approach. *Pharmacol Ther* 2007;114:56-73.
- 24 [32] Shegogue D, Trojanowska M. Mammalian target of rapamycin positively regulates
25 collagen type I production via a phosphatidylinositol 3-kinase-independent pathway. *J*
26 *Biol Chem* 2004;279:23166-75.
- 27 [33] Pallet N, Thervet E, Le Corre D, Knebelmann B, Nusbaum P, Tomkiewicz C et al.
28 Rapamycin inhibits human renal epithelial cell proliferation: effect on cyclin D3 mRNA
29 expression and stability. *Kidney Int* 2005;67:2422-33.
- 30 [34] Zhang W, Wagner BJ, Ehrenman K, Schaefer AW, DeMaria CT, Crater D et al.
31 Purification, characterization, and cDNA cloning of an AU-rich element RNA-binding
32 protein, AUF1. *Mol Cell Biol* 1993;13:7652-65.
- 33 [35] Blackshear PJ. Tristetraprolin and other CCCH tandem zinc-finger proteins in the
34 regulation of mRNA turnover. *Biochem Soc Trans* 2002;30:945-52.
- 35 [36] Gherzi R, Trabucchi M, Ponassi M, Ruggiero T, Corte G, Moroni C et al. The RNA-
36 binding protein KSRP promotes decay of beta-catenin mRNA and is inactivated by
37 PI3K-AKT signaling. *PLoS Biol* 2006;5:e5

[37] Berthier CC, Wahl PR, Le Hir M, Marti HP, Wagner U, Rehrauer H, et al. Sirolimus ameliorates the enhanced expression of metalloproteinases in a rat model of autosomal dominant polycystic kidney disease. *Nephrol Dial Transplant* 2008;23:880-9.

Accepted Manuscript

1
2
3
4
5
6
7
8
9
10
11
12
13
14
15
16
17
18
19
20
21
22
23
24
25
26
27
28
29
30
31
32
33
34
35
36
37
38
39
40
41
42
43
44
45
46
47
48
49
50
51
52
53
54
55
56
57
58
59
60
61
62
63
64
65

Figure Legends

1
2
3
4
5
6
7
8
9
10
11
12
13
14
15
16
17
18
19
20
21
22
23
24
25
26
27
28
29
30
31
32
33
34
35
36
37
38
39
40
41
42
43
44
45
46
47
48
49
50
51
52

Figure 1. Dose-dependent inhibition of IL-1 β -induced gelatinolytic MMP-9 contents (A) and steady-state MMP-9 mRNA levels (B) by rapamycin. Quiescent MC were either left untreated (-), or treated for 24 h with IL-1 β (2 nM) in the absence (-) or presence of the indicated concentrations of rapamycin (Rapa) (A): 10 μ l of supernatants were subjected to SDS-PAGE zymography to assess the gelatinolytic levels of extracellular MMP-9. The migration properties of lytic bands, corresponding to inactive pro MMP-9 (92 kD), and the inactive and active forms of MMP-2 (72 and 68 kDa respectively) were determined using standard molecular weight markers. A densitometrical analysis of MMP-9 gelatinolytic activities derived from equal cell numbers from three independent experiments is given at the right panel. Data represent means \pm SD ($n = 3$) and are represented as arbitrary units. *** $P \leq 0.005$ compared with control; ## $P \leq 0.01$, ### $P \leq 0.005$ versus IL-1 β -treated conditions. (B). Northern blot analysis, showing the dose-dependent inhibition of IL-1 β -induced MMP-9 by rapamycin. Quiescent MC were stimulated as in (A). Total cellular RNA (20 μ g) was extracted and hybridized to a ³²P-labeled cDNA insert from KS-MMP-9 for Northern blot analysis as described in “Materials and Methods”. Equivalent loading of RNA was ascertained by rehybridization to a 18S RNA probe. A densitometrical analysis of three independent experiments is shown at the right panel. Results are expressed as means \pm SD ($n=3$) and are presented as % of MMP-9 mRNA induced by IL-1 β depicted as 100%. ** $P \leq 0.005$ compared with control; ## $P \leq 0.01$, ### $P \leq 0.005$ compared with IL-1 β -treated conditions.

53
54
55
56
57
58
59
60
61
62
63
64
65

Figure 2. Rapamycin upregulates TIMP-1 promoter activity and via a gene-specific SBE increases TIMP-1 expression. (A). MC were treated with either vehicle, IL-1 β (2 nM), rapamycin (100 ng/ml), or both in combination as indicated. After stimulation, 20 μ l of cell culture supernatants were subjected to Quantikine Immunoassay Kit for measurement of

1
2
3
4
5
6
7
8
9
10
11
12
13
14
15
16
17
18
19
20
21
22
23
24
25
26
27
28
29
30
31
32
33
34
35
36
37
38
39
40
41
42
43
44
45
46
47
48
49
50
51
52
53
54
55
56
57
58
59
60
61
62
63
64
65

TIMP-1 antigen levels. Data represent means \pm SD ($n = 4$). $*P \leq 0.05$, $**P \leq 0.01$, $***P \leq 0.005$ compared with corresponding control levels. $^{\#}P \leq 0.05$, $^{\#\#}P \leq 0.01$ versus IL-1 β -treated conditions. (B). Northern blot analysis, demonstrating a dose-dependent augmentation of IL-1 β -induced TIMP-1 mRNA levels by rapamycin. Quiescent MC were stimulated with either vehicle (-) or IL-1 β (2 nM) (+) for 24 h in the presence of the indicated concentrations of rapamycin. Total cellular RNA (20 μ g) was extracted and hybridized to a 32 P-labeled cDNA insert from KS-TIMP-1 for Northern blot analysis as described in “Materials and Methods”. Equivalent loading of RNA was ascertained by rehybridization to a 18S RNA probe. A densitometrical analysis of three independent experiments is shown at the right panel. Results are expressed as means \pm SD ($n=3$) and are presented as TIMP-1 mRNA relative to 18S rRNA. $*P \leq 0.05$, $**P \leq 0.01$, compared with control; $^{\#}P \leq 0.05$, $^{\#\#}P \leq 0.01$ versus IL-1 β -treated conditions. (C, upper panel). Quiescent MC were transiently cotransfected with 0.4 μ g of pGL-TIMP-1 (0.6 kb) and with 0.1 μ g of pRL-CMV coding for Renilla luciferase. After overnight transfection, MC were left untreated (vehicle), or treated for 24 hours either with rapamycin (100 ng/ml), or with IL-1 β (2 nM) in the absence or presence of the indicated concentrations of rapamycin. The values for beetle luciferase were related to values for Renilla luciferase and are depicted as relative light units (RLU). Data represent means \pm SD ($n=6$). $*P \leq 0.05$ compared with control or versus $^{\#}P \leq 0.05$, $^{\#\#}P \leq 0.01$ IL-1 β -stimulated values. (C, lower panel). Dose-dependent activation of Smad-2 and Smad-4 by rapamycin. Quiescent MC were stimulated for 30 min similar as described above. 30 μ g of nuclear extracts were successively probed with either an anti-phospho-Smad-2 antibody or, with an antibody directed against Smad-4. Loading of equal amounts of nuclear extracts was ascertained by reprobing the blots with an anti-HDAC-1 antibody. Westernblots are representative for three independent experiments giving similar results. (D). Subconfluent MC were transfected with 0.4 μ g of either pGL-TIMP-1 (white bars) or, alternatively, with the

1 same promoter bearing a mutated SBE (pGL-TIMP-1 Δ SBE, black bars). Transfection of the
2 plasmids was supplemented by a cotransfection with 0.1 μ g of RL-CMV, coding for *Renilla*
3 luciferase as described in (C). After transient transfection MC were treated for 16 hours with
4 either vehicle, IL-1 β (2 nM), rapamycin (100 ng/ml) or IL-1 β plus rapamycin as indicated
5 before extracted for total cell lysates and assayed for luciferase activities. Values for *beetle*
6 luciferase were related to the values for *Renilla* luciferase and are depicted as relative light
7 units (RLU). Data represent the means \pm S.D. (n=6) of triplicate experiments. **, p \leq 0.01
8 compared with vehicle.
9
10
11
12
13
14
15
16
17
18
19
20
21

22 **Figure 3. Amplification of IL-1 β -triggered AP-1 and NF- κ B activities by rapamycin.**

23 (A, upper panel). Western blot analysis demonstrating a dose-dependent amplification of the
24 IL-1 β -induced content of nuclear phospho-c-Jun and nuclear translocation of the NF- κ B
25 subunit p65 by rapamycin. Serum-starved MC were stimulated for 30 min with either vehicle
26 (-), IL-1 β (2 nM), rapamycin (100 ng/ml), or a combination as indicated before cells were
27 harvested for nuclear extracts. For Western blot analysis 50 μ g of nuclear extracts (nuclear)
28 were subjected to Western blot analysis and successively probed with an anti-phospho-c-Jun-
29 specific (p-c-Jun-Ser63), anti-c-Jun-specific (c-Jun) and anti-p65-specific antibodies,
30 respectively. Loading of equal amounts of nuclear extract was ascertained by reprobing the
31 blots with an anti-HDAC-1 antibody. (A, lower panel). Protein lysates (60 μ g) from
32 corresponding cytoplasmic fractions were subjected to SDS-PAGE and immunoblotted using
33 an anti-I κ B α polyclonal antiserum. To correct for variations in the protein loading, the blot
34 was stripped and reincubated with an anti- β -actin antibody. (B). The DNA-binding of NF- κ B
35 (upper panel) and AP-1 (lower panel) was analysed by EMSA using gene-specific
36 oligonucleotides from the rat MMP-9 promoter as described in 2.8. 5 μ g of the same nuclear
37 extract preparations described in (A) were incubated in the binding reaction and DNA-bound
38
39
40
41
42
43
44
45
46
47
48
49
50
51
52
53
54
55
56
57
58
59
60
61
62
63
64
65

1 complexes were resolved from unbound DNA by non-denaturing gel electrophoresis. The
 2 EMSAs shown are representative of three independent experiments giving similar results.
 3
 4 Supershift analysis shown on the right panels identifying p65 as a major constituent of NF- κ B
 5 (upper panel) and c-Jun as a main constituent of the AP-1-bound complex (lower panel). For
 6
 7 supershift analysis, the indicated antibodies were applied as described in “Materials and
 8
 9 Methods.”
 10
 11
 12
 13
 14
 15
 16
 17

18 **Figure 4. Rapamycin amplifies IL-1 β -induced MMP-9 promoter activity via a proximal**
 19 **AP-1 binding site at -87.**
 20
 21

22 (A). Schematic representation of the different 1.3 kb MMP-9 luciferase constructs, either
 23 nonmutated (pGL3-MMP-9) or modified by single point mutations of the indicated
 24 transcription factor binding sites. (B, C). Promoter activities of wild-type (pGL3-MMP-9) (B,
 25 left panel) or corresponding pGL3-MMP-9 promoter constructs point mutated in a NF- κ B
 26 binding site (pGL-3MMP-9 Δ NF- κ B) (B, right panel), a proximal (pGL-3MMP-9 Δ AP-1/-87)
 27 (C, left panel) or a distal AP-1 binding site (pGL-3MMP-9 Δ AP-1/-504) (C, right panel).
 28
 29 After overnight transfection, MC were left untreated (vehicle), or treated for 24 hours with IL-
 30
 31 1 β (2 nM), rapamycin (100 ng/ml), or both in combination as indicated. Preparation of cells
 32 and subsequent measurement of dual luciferase activities was done as described in 2.5. The
 33 values for beetle luciferase were related to values for Renilla luciferase and are depicted as
 34 relative light units (RLU). Data represent means \pm SD ($n=6$). $P \leq 0.01$ (**, ##) or $p \leq 0.005$
 35 (***) compared with control (**) or with IL-1 β -stimulated values (##).
 36
 37
 38
 39
 40
 41
 42
 43
 44
 45
 46
 47
 48
 49
 50
 51
 52
 53
 54
 55

56 **Figure 5. Inhibitory impact of the 3'-UTR of MMP-9 on rapamycin-triggered MMP-9**
 57 **promoter induction.** (A). Quiescent MC were left untreated (vehicle) or stimulated for 20h
 58 with IL-1 β (2 nM) to reach a maximal level of MMP-9 mRNA. Thereafter, cells were washed
 59
 60
 61
 62
 63
 64
 65

1 and incubated with actinomycin D (Act D, 5 μ g/ml) before being either directly extracted for
2 total cellular RNA (vehicle, IL-1 β), or additionally treated for further 12 h in the presence (IL-
3 1 β +ActD+Rapa) or absence (IL-1 β +Act D) of rapamycin (100 ng/ml). Changes in MMP-9
4 mRNA levels were determined by qRT-PCR by normalising MMP-9 mRNA to either EEF-2
5 mRNA (white bars), or to GAPDH mRNA (black bars). The results are means \pm SD (n=4) and
6 are presented as relative MMP-9 mRNA values. (B). The schematic drawing depicts a
7 luciferase construct of a 1.3 kb fragment of the rat MMP-9 wild-type promoter which
8 additionally contains the 3'-UTR of rat MMP-9 downstream of the luciferase coding region
9 (pGL-3-MMP-9/3'-UTR). This construct was used for assessment of a modulatory impact of
10 the 3'-UTR on MMP-9 promoter activity. Luciferase activities of pGL3-MMP-9/3'-UTR are
11 shown at the bottom. After overnight transfection, MC were left untreated (vehicle), or treated
12 for 24 hours with IL-1 β (2 nM), rapamycin (100 ng/ml), or both in combination as indicated.
13 The values for beetle luciferase were related to values for Renilla. Data represent means \pm SD
14 (n=6). P \leq 0.005 (***) compared with control.
15
16
17
18
19
20
21
22
23
24
25
26
27
28
29
30
31
32
33
34
35
36
37
38
39
40
41
42
43
44
45
46
47
48
49
50
51
52
53
54
55
56
57
58
59
60
61
62
63
64
65

Figure 1

A.

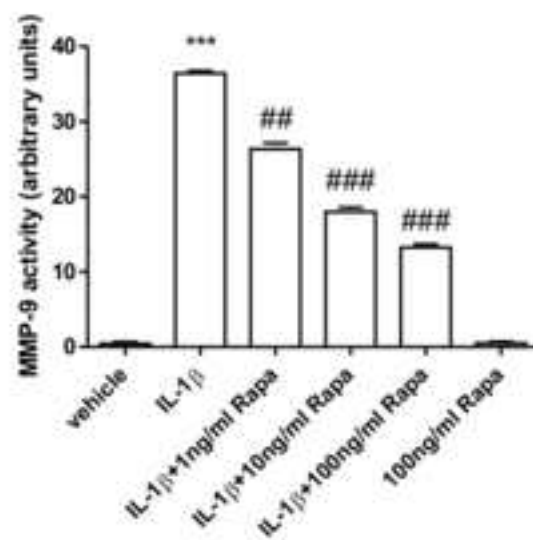
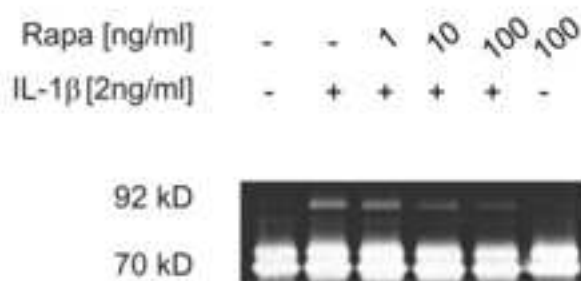

B.

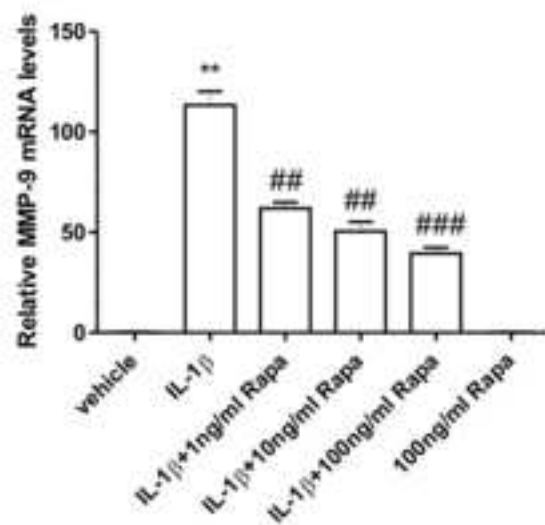
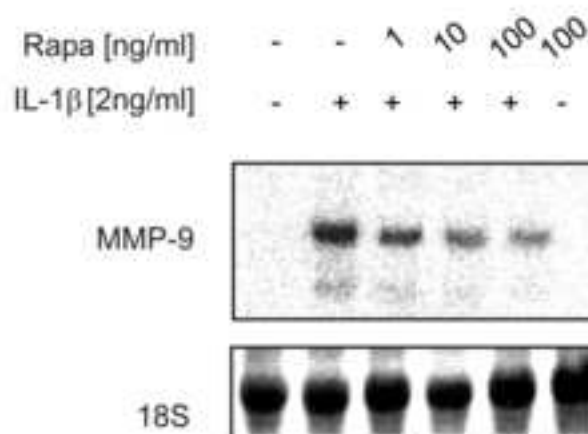
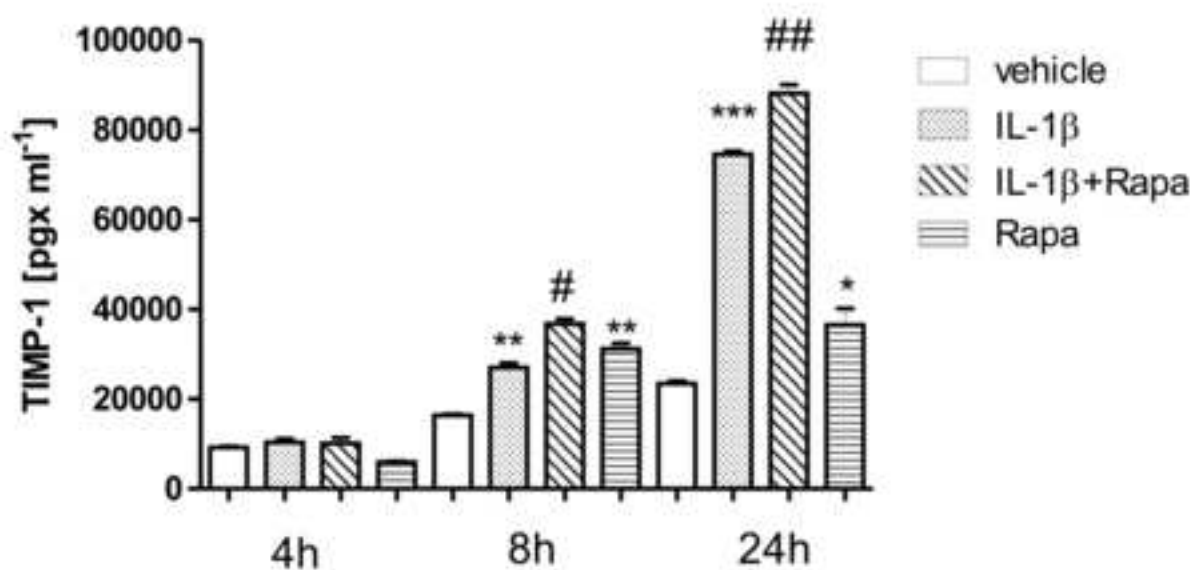

Figure 2

A.



B.

IL-1 β [2ng/ml]	-	+	+	+	+	-
Rapa [ng/ml]	-	-	1	10	100	100

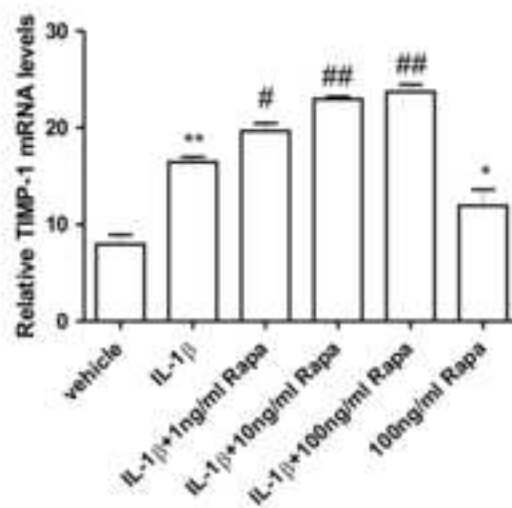
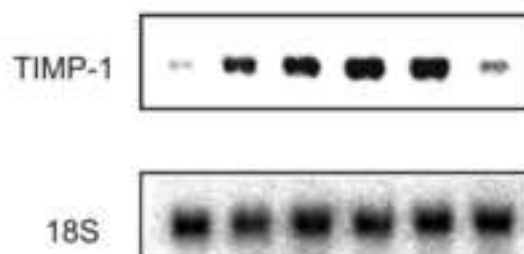
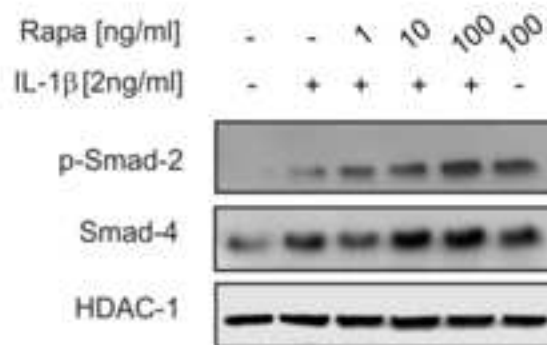
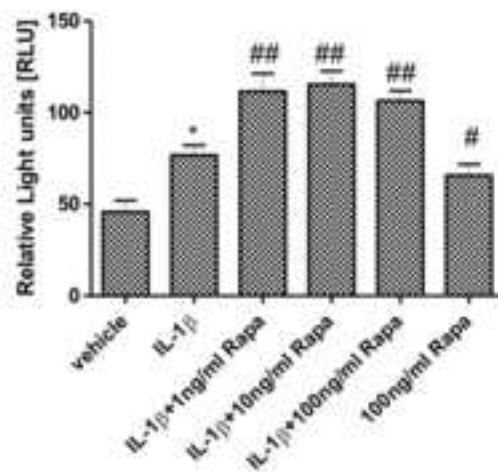

Figure 2

C.



D.

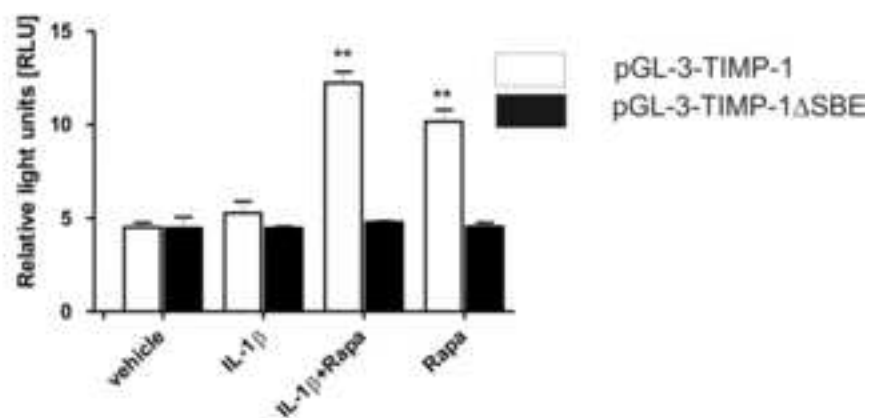
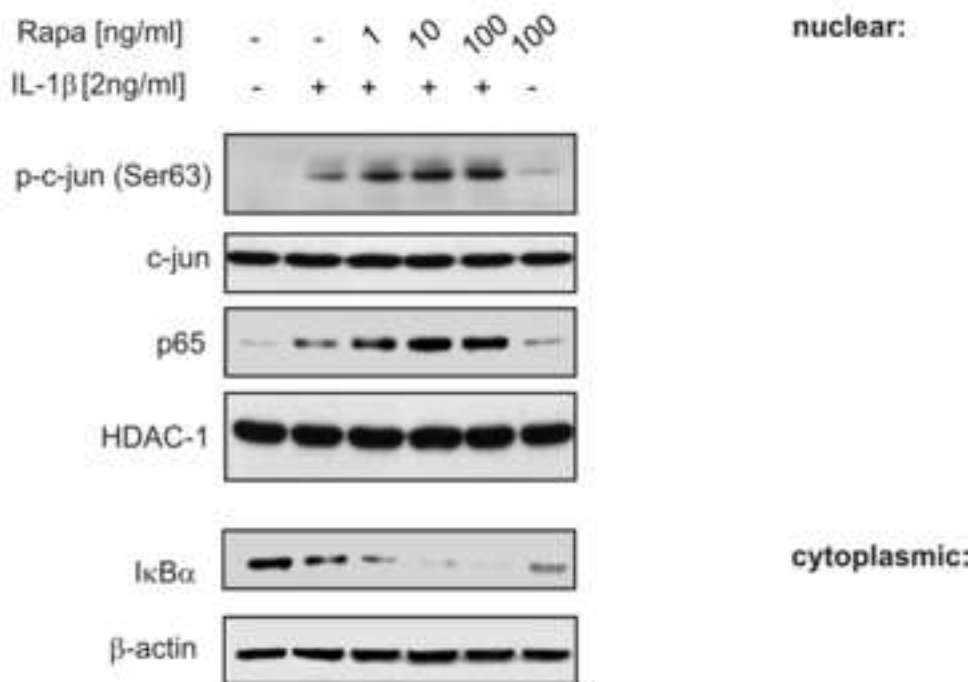

Figure 3

A.



B.

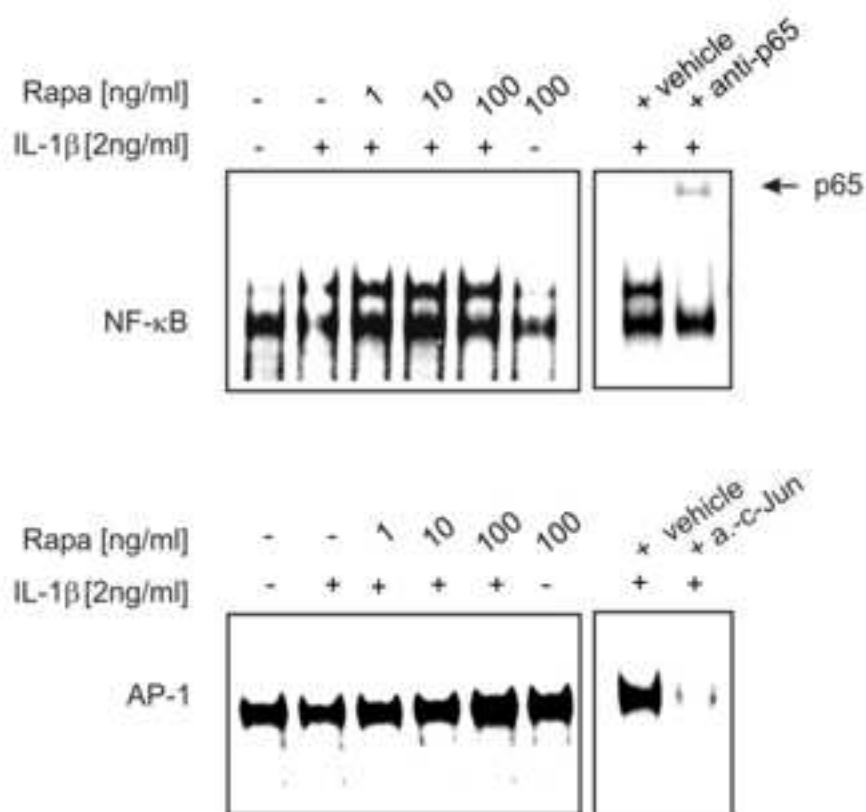

Figure 4

A.

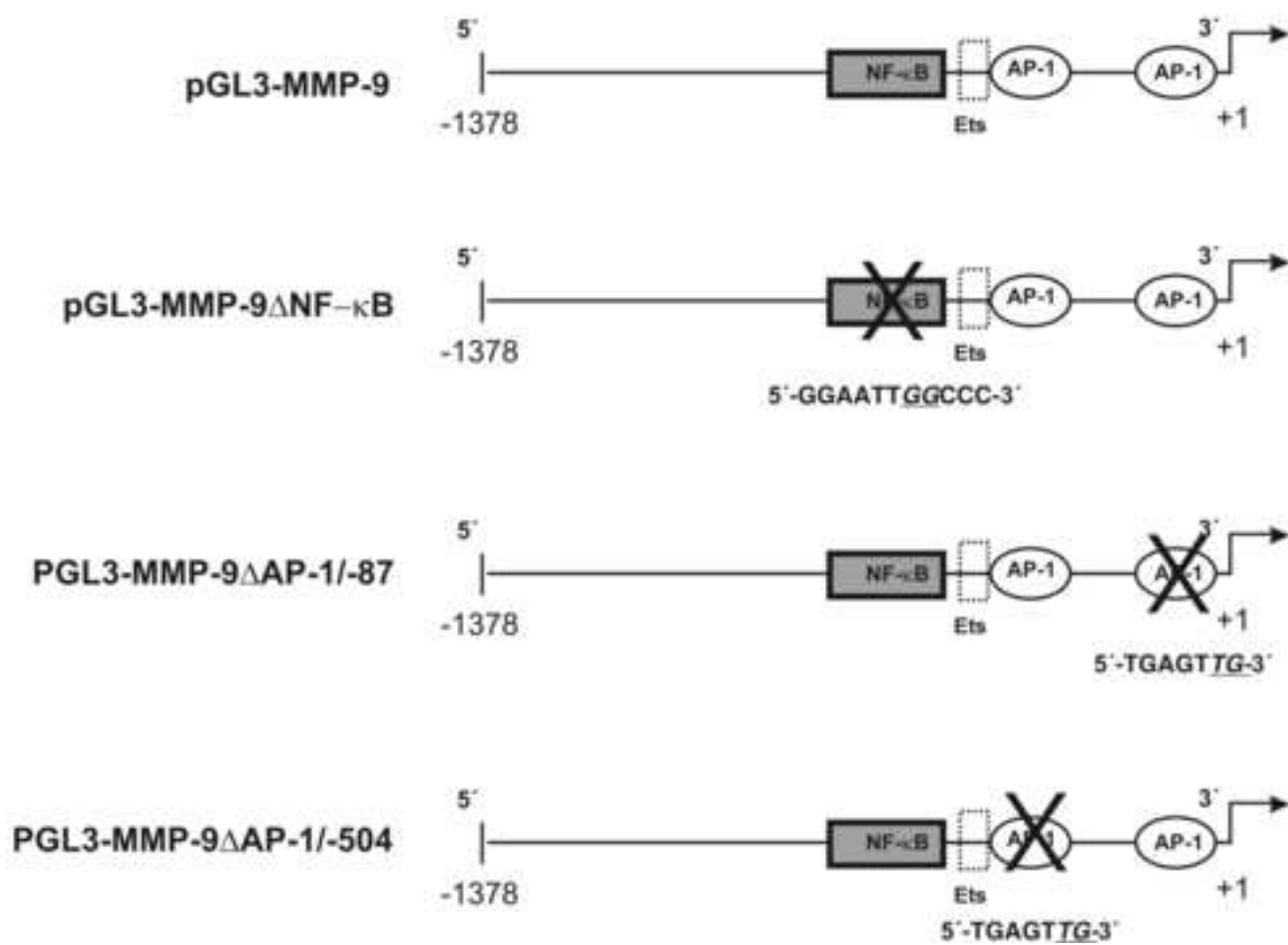

Figure 4

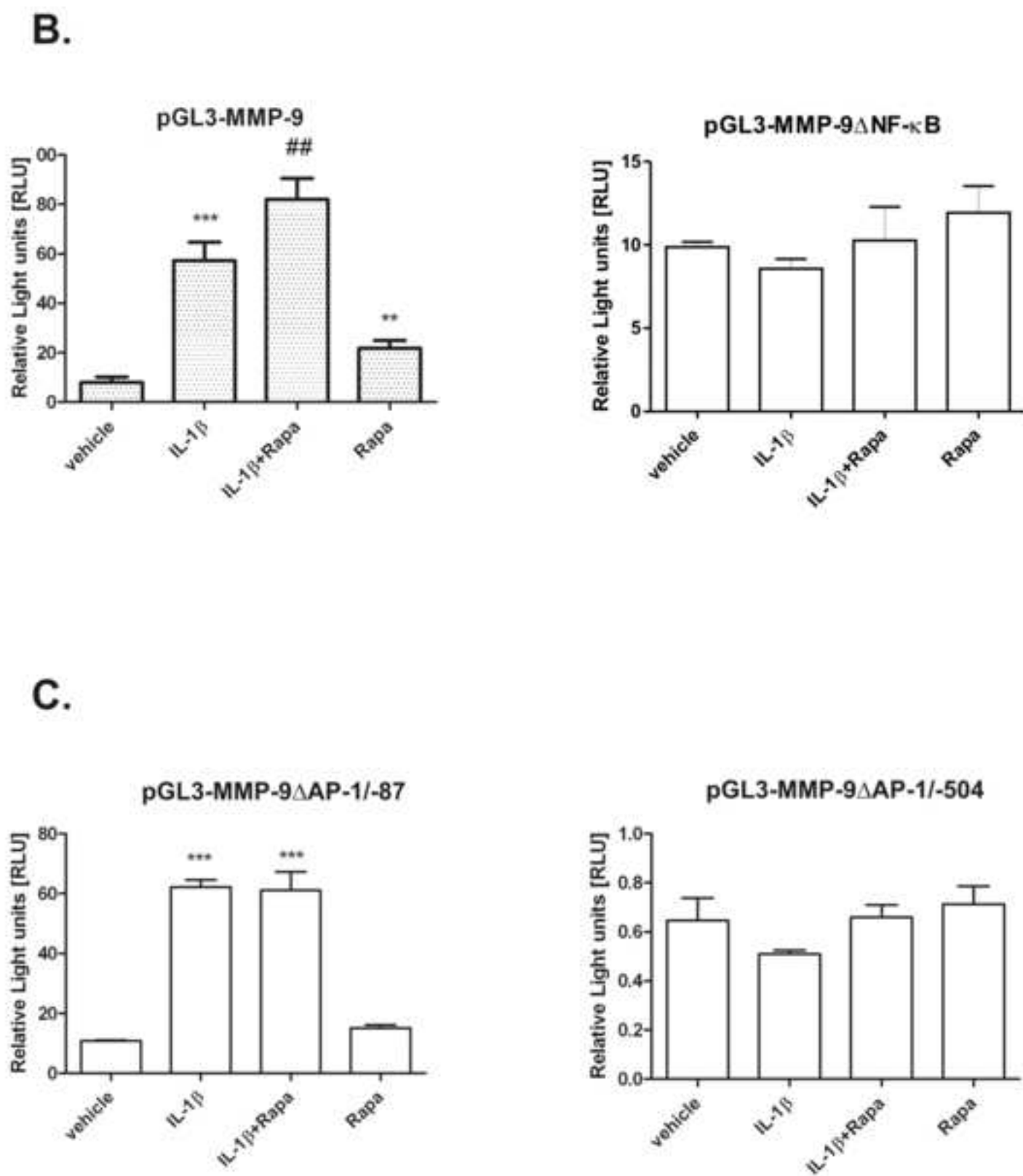
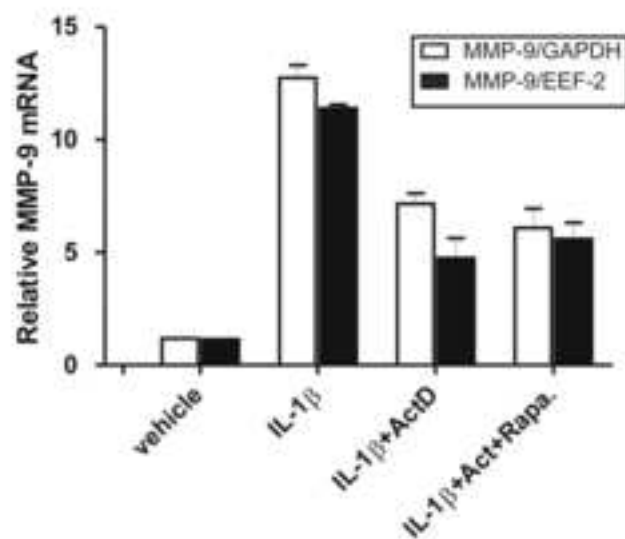

Figure 5

A.



B.

pGL3-MMP-9/3'-UTR

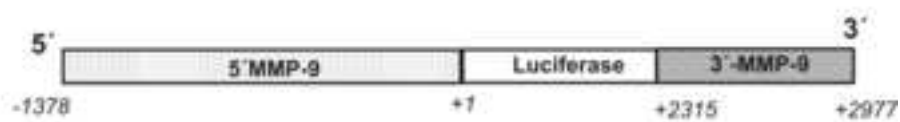

pGL3-MMP-9/3'-UTR

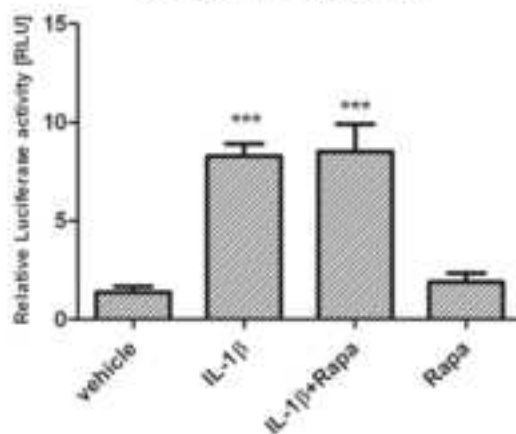

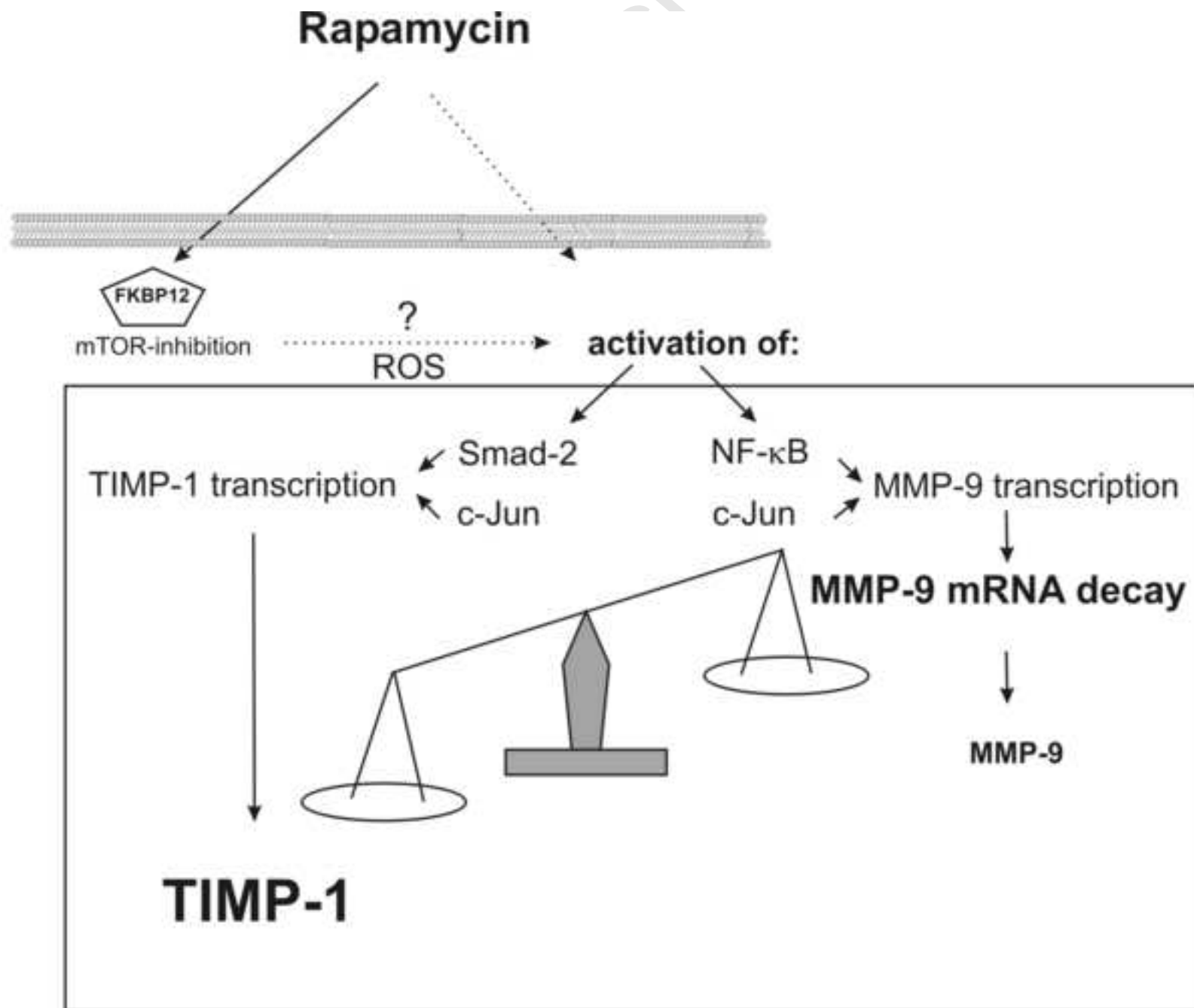

Fibrosis