

Measurements for fuel reforming for scramjet thermal management and combustion optimization : status of the COMPARER project.

N. GASCOIN^{*}, P. GILLARD[†], S. BERNARD[‡], G. ABRAHAM¹

Orleans university, Laboratoire Energétique, Explosion, Structure - 63, rue de Lattre de Tassigny - 18020 Bourges Cedex

M. BOUCHEZ[§], E. DANIAU^{**},
MBDA-France, 8 rue Le Brix, 18020 Bourges Cedex, France

Y. TOURE^{††}

Orleans university, Laboratoire Vision Robotique - 63, rue de Lattre de Tassigny - 18020 Bourges Cedex

It is common knowledge that one of the main issues of hypersonic flight is the thermal management of the overall vehicle and more specifically the cooling of the engine, since even composite materials can't withstand the large heat load found in a Scramjet combustion chamber. Another critical point is that mixing and combustion should be sufficiently fast in order to avoid long combustion chamber caused by supersonic internal flow and short residence time. Cryogenic fuels are a logical choice but their lack of storability and low density make them second choice compared to liquid hydrocarbons for small vehicle application. Researches are currently conducted in order to optimize the cooling by the endothermic thermal decomposition of the fuel itself circulating through the engine. The other benefit of this decomposition is the expected shift in the fuel mole fraction, from heavy hydrocarbons (with long induction delays), to light species (mainly H₂, CH₄ and C₂H₄).

MBDA-F launched with Orleans University a collaborative project named COMPARER, focusing on system analysis to identify one or two characteristic parameters (able to be measured) needed to understand and control the complex phenomena involved in the presented cooling technology and to evaluate some associated sensors. COMPARER is the French acronym for "CONTROL and Measure of PARAMeters in a REacting stReam". The aim of this project is to identify one or two characteristic parameters (able to be measured) needed to understand and control the complex phenomena involved in the presented cooling technology and to evaluate some associated sensors.

Computations are first performed, leading to the design of a specific well-documented test bench where the "innovative" techniques will be tested in an realistic environment in steady state and in unsteady computations. Many measurements techniques to be applied to measure the decomposed fuel features in flight were scanned, on the principle basis, then with the help of existing numerical simulations and models (NANCY, CHEMKIN, HITRAN, ...).

A specific test bench has been designed, with some characterization methods (not to be used in flight) on another hand and a place to test "COMPARER" systems planned to be possibly used in flight for actual regulation of a hydrocarbon-fuel-regeneratively-cooled engine. The paper shows results obtained at this test

^{*} PhD, Nicolas.Gascoin@bourges.univ-orleans.fr, AIAA Member.

[†] University Professor, Philippe.Gillard@bourges.univ-orleans.fr.

[‡] Researcher, Stephane.Bernard@bourges.univ-orleans.fr

¹ PhD, Gregory.Abraham@bourges.univ-orleans.fr

[§] Aerospace engineer, marc.bouchez@mbda.fr, AIAA Member.

^{**} Aerospace engineer, emeric.daniau@mbda.fr, AIAA Member.

^{††} University Professor, scientific head of Orleans University, Youssoufi.Toure@bourges.univ-orleans.fr.

bench up to full C12H26 decomposition up to 6 MPa pressure as well as three examples of possible “simple” measurement techniques to be used on an actual system.

Nomenclature

- C/SiC : carbon / silicon carbide composite
- CC : Combustion Chamber
- DMR : Dual Mode Ramjet
- GC : gaz chromatography
- PAH : Polycyclic Aromatics Hydrocarbons
- MS : mass spectrometry
- λ : thermal conductivity ($\text{W}\cdot\text{m}^{-1}\cdot\text{K}^{-1}$)
- ρ : density ($\text{kg}\cdot\text{m}^{-3}$)
- C_p : heat capacity ($\text{J}\cdot\text{kg}^{-1}\cdot\text{K}^{-1}$)
- η : viscosity (Pa.s)

I. Introduction

Hypersonic flight is expected to be achieved with dual-mode-Ramjet (Ramjet under Mach 6 and Scramjet beyond) because of its high specific impulse and its capability to be reusable (especially interesting for space transportation)¹, but one of the main issues at these flight conditions is the thermal management of the engine and the vehicle. Different cooling strategies have been evaluated by MBDA-France (calculations, material tests). Metallic panels have been tested as composite ones (C/SiC)², which seem to be promising. But even composite materials could not withstand such large heat load (for example, total temperature of external air reaches 2000 K at Mach 7 and combustion add more energy as the inner part of the engine cannot be radiatively cooled). Consequently an active cooling system has to be used but not a dedicated one because it would increase the vehicle weight. Furthermore, another issue occurs under these flight conditions. The time allocated to mix the injected fuel with inlet air, to ignite the combustion and to complete it before the chamber outlet is about 1 ms.

These two points lead to the so-called "regenerative cooling" solution : using the fuel to cool down the engine's wall and then burning it in the CC. The fuel is injected in a composite channel (which surrounds the engine) near the outlet of the CC, it flows to the injection on the opposite way of the burned gases. A heavy hydrocarbon fuel is chosen here because of its high density compared to cryogenic fuels ($800 \text{ kg}\cdot\text{m}^{-3}$ instead of $70/80 \text{ kg}\cdot\text{m}^{-3}$ for cryogenic hydrogen, with a specific impulse of liquid hydrocarbon halved)³. When heated and pyrolysed, it produces lighter hydrocarbons species that are both more energetic and easier to ignite. This point allows responding to rapid phenomenon in the CC.

But this cooling system requires knowing firstly how the fuel is decomposed and ensures the cooling and secondly how it will burn in the CC (to manage the thrust). It has to be noticed that due to the expected high pressure in the cooling loop ($>3 \text{ MPa}$) the fluid becomes supercritical in the channel, which leads to some modelling difficulties (fluid properties and flow rate measurement) for the cooling study. The injected flow rate is expected to be slightly different from the one pumped out of the tank because a carbon deposit (coke) could appear at high temperature (above 1000 K) and because transpiration cooling is planned to be used through the mastered porosity of the C/SiC wall. This phenomenon will also change the carbon/hydrogen ratio of the fuel in the channel. This point needs to be studied because it influences the combustion and *a priori* the thrust.

In addition to the long established cooperation with ONERA^{4 5} on this topic, MBDA launched two small-scale programs in collaboration with French laboratories and universities⁶.

II. Future measurements for hydrocarbon-cooled reactive systems

A. Presentation of the COMPARER project

COMPARER is the French acronym for "Control and Measure of Parameters in a REacting stReam". The aim of this project is to identify one or two characteristic parameters (able to be measured) needed to understand and control the complex phenomena involved in the presented cooling technology and to evaluate some associated sensors.

The different actors of this program are MBDA-F, the "Laboratoire Energétique, Explosions et Structures" (LEES, explosions dynamics and reactive systems laboratory), the "Laboratoire Vision et Robotique" (LVR, vision and robotics laboratory) and the "Pôle Capteurs & Automatismes" (excellence centre for sensors and control), all located in Bourges, in France.

The target is to define and to evaluate, by means of calculation and of experimentation, one or two innovating technologies for the measurement of characteristic parameters of a heated hydrocarbon at high temperature (mass flow rate, specific chemical species).

These measurement techniques will eventually be used for experimental engines (for example for

ground testing during development phase of hydrocarbon-cooled system) as well as operational systems.

If primary applications are regeneratively hydrocarbon cooled engines such as dual-mode ramjets, the techniques could be used for the measurement and the control of any system dealing with heat exchanges and hot/decomposed hydrocarbons : fuel cells for example.

B. Hydrocarbon reacting systems computations

The used strategy was to headline the different parts of the engine involved in the cooling. The coupling between the combustion chamber and the possibly porous hot skin cooled by the hydrocarbon fuel was selected. The question of burning capability of the decomposed hydrocarbon was also addressed. Then, steady simulations have been conducted with a specific code⁷ developed thanks to the existing in-house MBDA program (called NANCY). This code deals with stationary heat exchanges between two fluids flowing upstream. Implemented fluids are air, nitrogen, water and hydrogen, but it is possible to input other fluids (such as kerosene or endothermic hydrocarbons⁸) by defining their thermal characteristics versus their temperature and pressure. The code calculates step by step walls and fuel temperatures of each section and thus the cooling of the panels. Moreover it estimates thermal and mechanical stresses in the coolant channel material and computes the pressure drop.

The code can be coupled with kinetic modeling of the fuel degradation, here with detailed a pyrolysis mechanism⁹ for the n-dodecane written in CHEMKIN II format. The code allows taking into account the endothermic effects on the wall cooling¹⁰.

This numerical tool was used both for the study of a generic DMR used as reference as well as to perform many preliminary computations of the COMPARE test bench that has been used since end of 2005 and will be presented below.

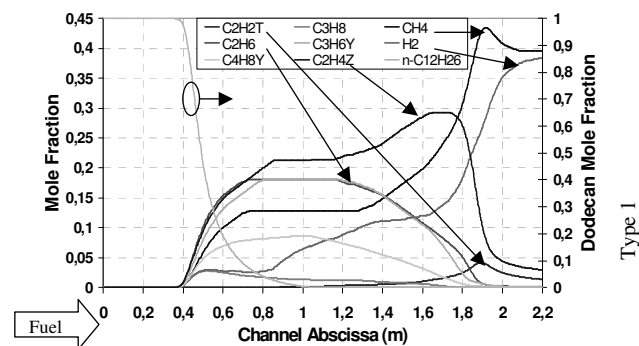

Figure 1. Repartition of components concentrations in a cooling channel of a generic DMR ($C_{12}H_{26}$).

Different test cases have been calculated for various heat wall fluxes, channel length and configuration, fuel flow rate, pressure condition.

The Figure 2 shows the fuel remaining mole fraction as a function of the fuel temperature.

We could conclude that for a limited range of residence time (from tenth of seconds to seconds), the pyrolysis of long-chain alkane such as $C_{12}H_{26}$ temperature-dependent except in a small area where the conversion rate is maximal (slightly above 1000 K). These computations were conducted with elementary reactors with various residence times from 0,1 s to 1 s.

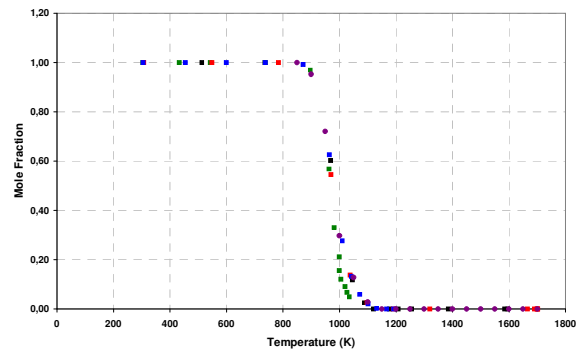

Figure 2. Main effect of the temperature on the $C_{12}H_{26}$ pyrolysis

Previous computations taking into account the fuel mass flow rate and the expected heat fluxes show that the fuel temperature in our DMR engine is expected to reach 1300 K and maybe up to 1500 K in some cases, such high temperatures leading to a clear 100 % conversion degree.

With the decomposition of the initial molecule, a lot of secondary products could be found in the fuel (Figure 1). For the chained alkane, the main products are ethylene (C_2H_4), ethane (C_2H_6) methane (CH_4) and hydrogen at high temperature (H_2)).

The case of hydrogen is very interesting because its production rate in the primary mechanism is very low and that any large mole fraction of H_2 implies also a large number of lowly hydrogenated components such as benzene (C_6H_6), toluene (C_7H_8), PAH and even coke.

From Figure 1, it appears that the pyrolysis of long chain alkanes occurs in two step. The first step involve the decomposition of the initial molecule and the formation of a wide range of middle-weight compounds, mainly alkenes and alkanes.

After this step, and if the temperature increases again, the middle-weight compounds start their pyrolysis with the formation of hydrogen, methane and coke.

Further investigation is currently taking benefit of more complex modelling such as 3D thermal-hydraulic computations¹¹ or hydrocarbon fuel kinetic modelling⁹, under current development for industrial use by MBDA FRANCE with some research institutes.

Another interest is the capability to check the unsteady behaviour of such a cooled structure. NANCY is a steady state code, but similar unsteady version called RESPIRE is under validation with the same models but other 1D equations and numerical scheme¹².

III. A well documented experiment to investigate possible measurement systems

A. The COMPARER test bench

In order to identify the possible and interesting control measurements, some generic engines were studied in steady conditions, and the different parts of the coupling cooling/burning loop was analyzed with pluridisciplinary, simplified but unsteady approach.

This sensitivity analysis allowed us to headline critical parameters and to develop strategies to implement the measurement of those parameters in a real engine.

The next step of this program was to build a research test bench (Figure 3) that will enable the development and calibration of specific sensors that could be used for the on-board regulation of a DMR.

The combustion heating of the cooling circuit is simulated thanks to a high temperature oven.

The cooling channel is reduced to a single cylindrical chemical reactor (tube) with different possible geometries and materials.

The future measurement system is evaluated at the exit of the tube, outside of the oven.

The combustion process is today simulated by a cold academic burner that allows to burn the non-condensed part of the decomposed-then-cooled hydrocarbon fluid.

Test series were conducted with liquid dodecane, some test were done with pure hydrocarbon gases.

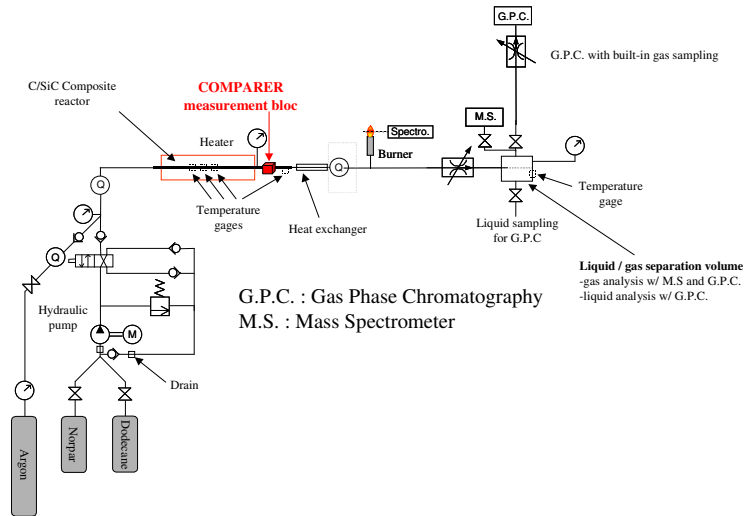

Figure 3. COMPARER test bench sketch

The fuel is flowing through a metallic (or in the future C/SiC) reactor installed in a high temperature oven (1800 K) and then passes through a measurement prototype block, then is cooled and burnt in an academic flame.

This working bench will be used to validate the unsteady model of the engine and to evaluate different real time measurement techniques on the decomposed fuel : mass flow, decomposition level and capacity to burn.

The identified techniques can be tested on laboratory level on the fuel, at the exit of the reactor (located as "COMPARER measurement bloc" in Figure 3), with steady or unsteady conditions (temperature, fuel mass flow rate, etc). At least for steady operating points, some characterization is planned both on the decomposition of the fuel and on the academic burner, in order to analyze the COMPARER real time measurements.

Due to security and sizing consideration, the fuel mass flow rate in this reactor will be very low (0.05 to 0.5 g.s⁻¹) This way, the burner power at the end of the line is limited to 5 kW and a real time spectroscopy could be used as the combustion diagnostic device.



Figure 4 : general view of COMPARER test bench

B. Characterization of the hydrocarbon content at the exit of the oven.

A thermocouple can be implemented in the flow at the exit of the oven, upstream the “measurement block”.

The main diagnostic method on this test bench is the Gas Phase Chromatography coupled to a Mass Spectrometer. Those two methods will be used to cross-checked the results obtained with the future COMPARER sensors.

After the water-cooled heat exchanger, the hydrocarbon compound cooled at roughly 30°C is separated : the gaseous products are analysed by the CDG (varian CP 3800) while the condensed products are collected and analysed with a dedicated GC/M.S. device (Agilent).

The figures below show the results of these analysis for gaseous and liquid products, while the maximum temperature in the oven (and then the maximum fluid temperature) is increased.

The mass fractions are given referred to the phase proportion, the liquid phase is continuously decreasing with the temperature, while the decomposition rate is increasing.

This example is given for a test campaign obtained with automatic control of the dodecane pressure (1 MPa) with a mass flow of 0,05 g.s⁻¹ in a tube of 4.5 mm internal diameter in stainless steel 316 L

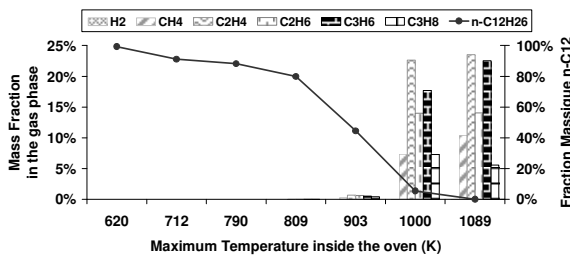

Figure 5 : example of the analysis of the gaseous products

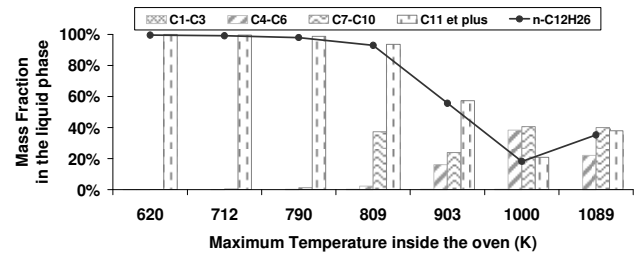

Figure 6 : example of the analysis of the liquid products

C. Characterization of the heating process

The oven is 900 mm long, but the heating process inside is not uniform.

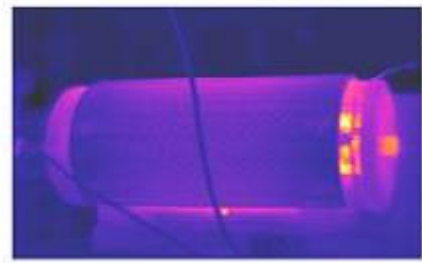

Figure 7 : external IR view of the oven (800°C operation)

It was characterized thanks to thermocouples at various locations, and associated computations were done.

The fuel is heated, then cooled but the kinetic detailed computation show that the decomposition level remains high.

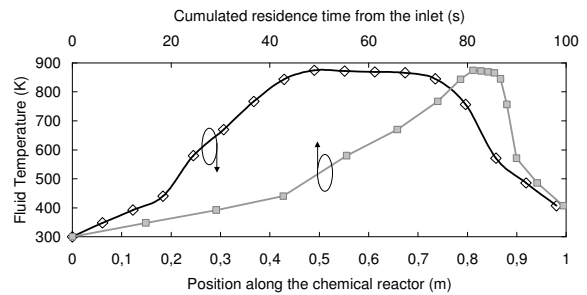

Figure 8 : computed fuel temperature and residence time along the tube in the oven

This computation illustrates how the considered channel is far away from a perfectly stirred reactor.

The C₁₂H₂₆ and CH₄ computed fractions are quite unchanged during the “cooling” part of the flow in the oven.

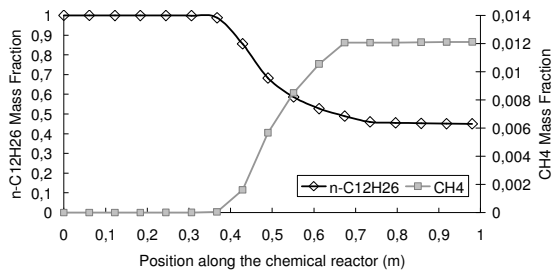

Figure 9 : computed $C_{12}H_{26}$ and CH_4 in the tube in the oven

D. Synthesis of the COMPARER test bench capability

The COMPARER test bench has been running since mid- 2005. Some adaptations of the test bench have increase the knowledge of transient changes on a chemical and cooling aspect (automatic pressure regulation and mass flow meter have been implemented available since May 2006).

The repeatability of the test bench operation is sufficient for the COMPARER objectives , as shown on the figure below obtained with a mass flow of 0.05 g.s^{-1} in a 6 mm internal diameter steel tube, with 900 K level of oven temperature.

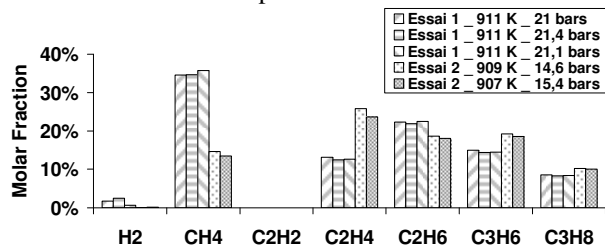

Figure 10: repeatability of the test bench conditions

An experimental parametric study was conducted and confirm the good operation of the test bench as well as its characterization devices. The expected and computed effect of pressure, temperature, mass flow, internal diameter were then confirmed (it is well known than in pyrolysis, temperature effect is the most sensitive, ,then residence time then pressure).

Some results are given below for a 316L tube with 3 mm inner diameter.

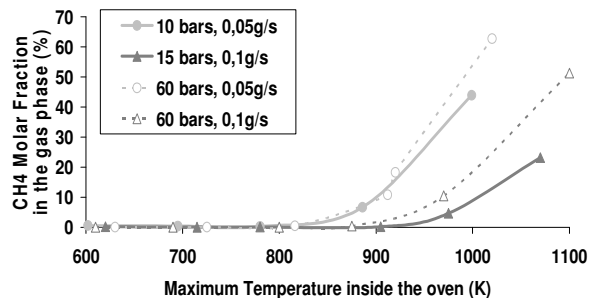

Figure 11 : effect of pressure and mass flow on CH_4 fraction (gaz)

The test bench is able to operate both in supercritical (60 bars for example) and gaseous states (10 bars for example).

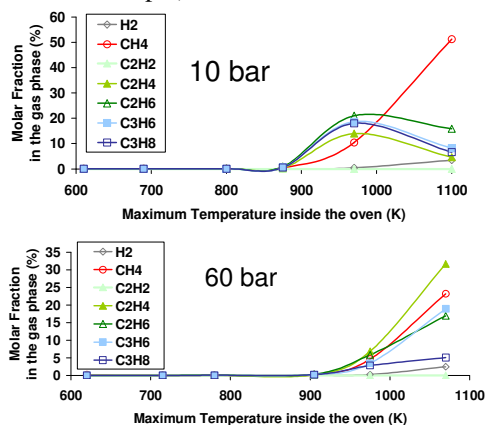

Figure 12 : effect of pressure on decomposition (10-60 bars)

Solutions were found in order to obtain long duration operating (several hours) without too much problems of coking.

Even if the residence time and the flow regime (mostly laminar) are different from expected conditions in an actual fuelled cooled engine, the conditions are well suitable for the development of future measurement techniques on hot hydrocarbon reacting flows in gaseous, liquid and supercritical states. The results would also help to the understanding of these kind of coupled systems and to the numerical tools validation.

Maximum values obtained with metallic tubes are the following :

- 60 bars (316 L hot stainless steel)
- Decomposition 100%
- Fuel temperature : 900 K in the furnace, 700 K at the exit
- Mass flow $< 0.6 \text{ g.s}^{-1}$

- Typical time residence : less than 100 seconds.

The future use of C/Sic tube will allow to reach higher level of temperature (maximum oven temperature is 1600°C).

IV. Investigation of possible operational measurement techniques

A. Introduction

As previously mentioned, the COMPARER project aims to investigate some measurements techniques that could be used for quick analysis of an actual complex system, on ground or in flight.

The possible techniques are first evaluated by computations, with the existing models. If they appear interesting, the COMPARER test bench is used to evaluate them experimentally.

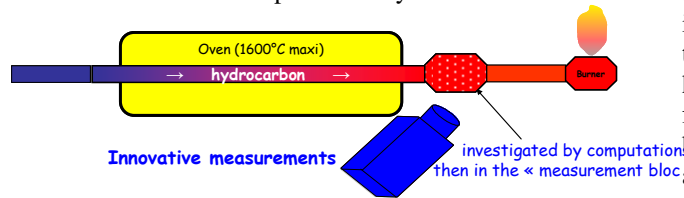

Figure 13 : principle of test of "innovative instrumentation" on COMPARER

The "measurement bloc" is a modular stainless steel system with thermocouples, optical or mechanical access.

It can be isolated from external natural cooling or temperature-stabilized thanks to heating wires.

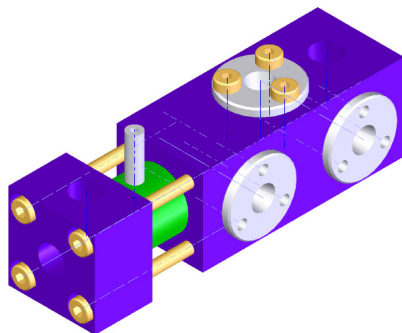

Figure 14 : CAD view of "measurement bloc"

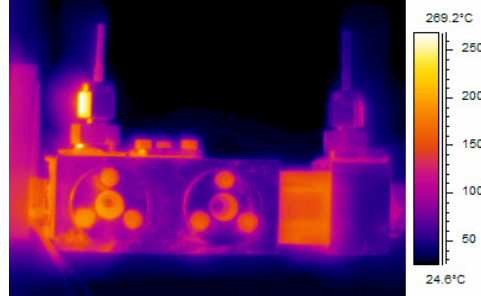

Figure 15 : IR view of measurement bloc during test

B. Predicting the fuel burning capability

Giving the fact that temperature is the first parameter governing the decomposition of hydrocarbons fuel, this parameter could be sufficient to know the pyrolysed mixture composition before injection in the combustion chamber. But to control the scramjet in terms of thrust, it is needed to predict how the injected fuel can burn. A criterion has to be found to represent the capacity for the mixture to burn. The inflammation delay could be chosen although other criteria like the fundamental flame velocity or the activation energy are of great interest. It can be chosen that the ignition delay should not be greater than 0.1 ms. It corresponds roughly to a tenth of the combustion chamber length as it is confirmed in the literature¹³.

Some preliminary work, with available models, has been performed in order to give a proposal for defining a "burning capability index" of the decomposed fuel⁶.

As an example, Figure 1 shows the different species mole fraction in a cooling channel. As some species are more able to burn than others, it is interesting to determine an "ideal" composition which could respond to the chosen criterion of 0.1 ms. Davidenko *et al.*¹⁴ estimates that a 20 % in mass of hydrogen is needed in a binary mixture of methane and hydrogen for the combustion in scramjet. It should be reminded that hydrogen – air mixtures typically exhibit the smallest ignition delay of all gaseous hydrocarbons and that methane – air mixtures, on the other hand, exhibit the longest ignition delay. It is too early to surely associate a criterion to control an actual regeneratively-cooled hydrocarbon-fueled DMR, but this analyses allows to identify some relationship between the composition or the characteristics (physical, optical, chemical, electrical, ...) of the decomposed fuel and its general capability to burn easily.

After a review of the possible measurement methods, passive IR spectroscopy was selected as one of the promising and usable ways.

Some computations of the fuel IR spectrum, as a function of the fuel temperature and composition, have been done with the HITRAN software¹⁵. This data bank was used out of its nominal validation : further spectrum measurement have to be done by specialized team on COMPAREER test bench to check the actual spectra of decomposed hydrocarbons at high temperature and pressure, including in supercritical state and with possible heterogeneity.

These HITRAN computations were compared with the laminar flames and ignition delay SENKIN computations.

- Luminance of hot fluids at given wavelength ...

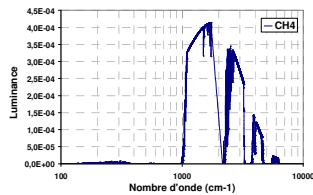

HITRAN 1996 computations

- Ignition delay
- Premix flame.

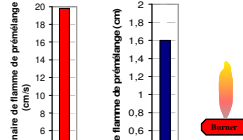

CHEMKIN computations

Figure 16 : preliminary computations of IR signal and possible correlation with combustion index

This theoretical preliminary work enable us to identify some interesting wavelengths. For example, one is located at 4170 cm^{-1} and its intensity is directly related to the methane mole fraction inside the mixture (Figure 17).

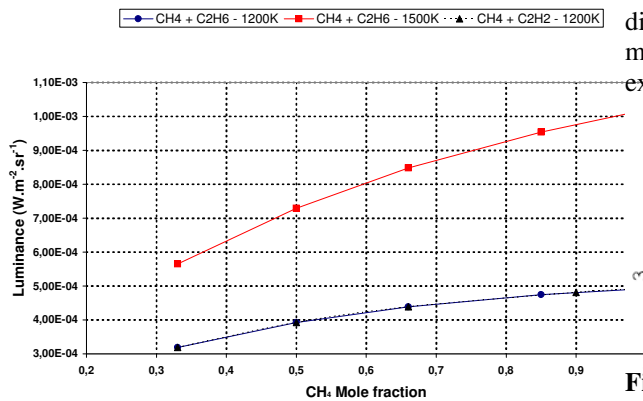

Figure 17. intensity of the 4170 cm^{-1} wavelength as a function of the temperature and the CH_4 mole fraction.

The COMPAREER test bench is a useful tool for testing the application of narrow-band, real-time IR spectroscopy to fuel analysis for engine control.

Preliminary measurement have been done in 2006 with the LEEE laboratory from Paris X university.

Spectra obtained with through the optical access of the “measurement bloc” with heated gases and dodecane are currently under analysis.

C. Possible use of sonic throat to measure the mass flow of decomposed hydrocarbon

Using the large amount of computations realized for various heating processes in generic actual engines or in the COMPAREER test bench, a computational analysis of the behaviour of the decomposed fuel in sonic conditions has been performed.

An example is given below, with the mass flow through a 1 mm^2 sonic throat given as a function of the decomposed $\text{C}_{12}\text{H}_{26}$ temperature (pressure is 3.5 MPa).

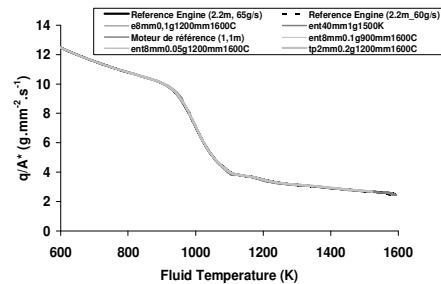

Figure 18 : computed mass flow through a sonic throat

The sonic throat seems to be a valuable solution.

A sonic throat implementation has been prepared on the measurement bloc, but the corresponding diameter is so small with the COMPAREER current mass flow that this point has not been yet experimented.

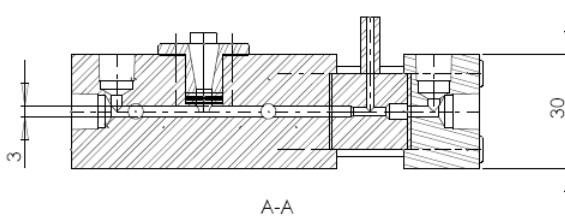

Figure 19 : sonic throat implementation in the measurement bloc

D. Relationship between gazeification and decomposition rate

Two important parameters are used to give a general view of the decomposition process in such an experiment.

The (molar) decomposition rate is the ratio between the part of initial fluid (here $C_{12}H_{26}$) that has been decomposed and its initial amount.

The (mass) gazeification rate is the ratio between the mass of gas products and the initial mass of fluid ($C_{12}H_{26}$ here).

The COMPARER experiments gives immediately the gazeification rate, by comparing the mass flows of gases, of liquids after the water-cooled heat exchanger and the pumped mass flow (if any leakage in case of porous reactor tube). In order to quickly obtain an estimation of the decomposition level, a theoretical relationship between these two rates was computed at MBDA-France, using the detailed pyrolysis mechanisms of $C_{12}H_{26}$. It was done in a 0D static numerical reactor, for fixed arrays of pressure, temperature and residence time.

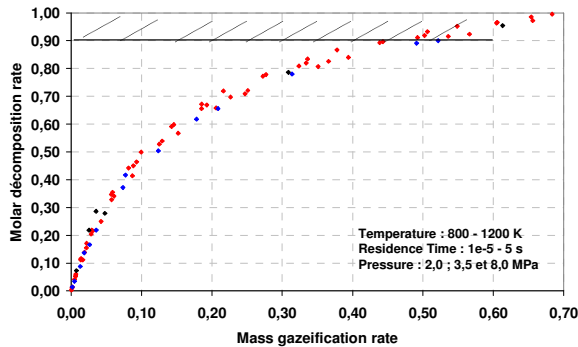

Figure 20 : theoretical relationship between gazeification and decomposition

The complete set of data obtained during COMPARER test bench first campaigns during the parametric study was analyzed in the same way. Some of the measures (referred as “experiment 2” in the Figure 21) are close to the “theoretical” curve, while others (referred as “experiment 1”) show more linear relationship.

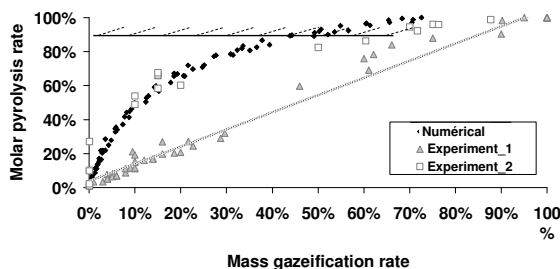

Figure 21 : experimental relationship between gazeification and decomposition

Analysis of these differences is currently done, using the associate 1D thermal-chemical modeling.

Nevertheless, this technique seems to be a simple way to characterize without detailed sampling with GC/MS of the heated hydrocarbon on an experimental engine, particularly in case of “open-loop” cooled structures experimental checking.

V. Conclusion

The COMPARER project focused on the characterization of hot fuel associated to the unsteady behavior of a cooling loop.

Some promising measurement are under further analysis. A small but complete specific test bench is now operational for the testing of those methods.

The first experimental results are quite promising.

Among the different “innovative” measurement systems, three were discussed in the present paper :

- Use of the gazeification level to estimate the decomposition rate.
- Use of a sonic throat for the hot decomposed fuel to measure its mass flow.
- IR spectroscopy to qualify its burning capability.

Besides these applications, the COMPARER project gives the opportunity to increase the scientific data and enhance the cooperation at scientific level on several dedicated topics with other laboratories or research institutes.

COMPARER-1 finished its 3 years, the second phase COMPARER-2 begins in October 2006, also for 3 years.

Acknowledgments

The authors want to thank for their contribution F. Falempin, E. Jennequin from MBDA-France, X. Rocourt and J.-C. Hargé from University.

The present work has been realised with the contribution of the "Conseil Général du Cher (18)", of the "Conseil Régional du Centre", of the FRED, of the FEDER, of the FSE (European Union) and of MBDA-France. The good evolution of the COMPARER project was made possible thanks to the contribution of Mr. Yves Parmantier, person in charge of the project and coordinator of the "Pôle Capteurs et Automatismes" of Bourges, which carried the project phases until their effective beginning.

References

- ¹ F. Falempin, D. Scherrer, G. Laruelle, Ph. Rostand, G. Fratacci, J.L.Schultz, "French hypersonic propulsion program PREPHA -results, lessons &

perspectives", *AIAA - 98 - 1565 – Norfolk, November 1998*.

² Bouchez, M., and Beyer, S., "PTAH-SOCAR fuel cooled composite material structure for dual mode ramjet and liquid rocket engine – 2005 status", *AIAA-2005-3434*.

³ Giraudot, T., Massot, A., Boselli, L., and Talbot, B., "Dual-fueled advanced high-speed ramjets : students paper", *AIAA-2002-5214, Orléans, France, October 2002*.

⁴ Serre, L., Falempin, F., "PROMETHEE : The French military hypersonic propulsion Program", *AIAA-2002-5141*.

⁵ Daniau, E., and Sicard, M., " Experimental and numerical investigations of an endothermic fuel cooling capacity for scramjet application ", *AIAA-2005-*.

⁶ Daniau, E. , Bouchez, M. Herbinet, O., Marquaire, P.M., Gascoin, N., Gillard, P., « Fuel reforming for scramjet thermal management and combustion optimization », *AIAA-2005-3403*.

⁷ Daniau, E., Bouchez, M., and Gascoin, N., "Scramjet Active Cooling Analysis Using n-Dodecane as a Generic Endothermic Fuel", *Thermochemical Processes in Plasma Aerodynamics, 12-14 July 2004, St Petersburg, Russia*.

⁸ Ser, F., Heinrich, B., Luc-Bouhali, A., "Carburants liquides endothermiques : problématique du refroidissement et projet d'études expérimentales à l'ONERA", *AAAF – Arcachon, France – March 2001*.

⁹ Dahm, K.D., Virk, P.S., Bounaceur, R., Battin-Leclerc, F., Marquaire, P.M., Fournet, R., Daniau, E., and Bouchez, M., "Experimental and modeling investigation of the thermal decomposition of n-dodecane", *Journal of Analytical and Applied Pyrolysis, 71 (2004) pp865-881*.

¹⁰ Gascoin, N. Gillard, P., Touré Y., Bernard, S., Daniau, E., Bouchez, M., 21 Octobre 2004, "Mesures et contrôle de paramètres pertinents pour la régulation d'un statoréacteur mixte refroidi", *Troisième Rencontre Capteurs (Bourges)*.

¹¹ Dufour, E., Bouchez, M., "Semi-empirical and CFD analysis of actively cooled dual-mode ramjets", *AIAA-2002-5126, Orléans, France*.

¹² N. Gascoin, P. Gillard, S. Bernard, Y. Touré, E. Daniau, E. Dufour, M. Bouchez, "Transient Numerical Model of Scramjet Active Cooling, Application to an Experimental Bench", 4th International Energy Conversion Engineering Conference and Exhibit (IECEC), 26-29 June 2006, San Diego, USA

¹³ Buriko, Y., Vinogradov, V., Goltsev, V., Waltrup, P.J., "Influence of Active Radical Concentration on

Self-Ignition Delay of a Propane/Air Mixture", *AIAA 2001-3958 (2001)*.

¹⁴ Davidenko, D., Gökalp, I., Dufour, E., (2002) "Kinetic mechanism validation and numerical simulation of hypersonic combustion of methane-hydrogen fuel", *AIAA 2002-5207*.

¹⁵ Rothman L. S. et al., "The Hitran Molecular Spectroscopic Database And Hawks (Hitran Atmospheric Workstation): 1996 Edition", *J. Quant. Spectrosc. Radiat. Transfer, Vol. 60, No. 5, (1998) 665-710*.