



HAL
open science

Measurements for fuel reforming for scramjet thermal management and combustion optimization: 2009 status of the COMPARER project

Grégory Abraham, Nicolas Gascoin, Stephane Bernard, Philippe Gillard,
Marc Bouchez, Julien Bertrand, Bruno Le Naour

► To cite this version:

Grégory Abraham, Nicolas Gascoin, Stephane Bernard, Philippe Gillard, Marc Bouchez, et al.. Measurements for fuel reforming for scramjet thermal management and combustion optimization: 2009 status of the COMPARER project. 16th AIAA/DLR/DGLR International Space Planes and Hypersonic Systems and Technologies Conference, Oct 2009, France. pp.7373. hal-00641628

HAL Id: hal-00641628

<https://hal.science/hal-00641628v1>

Submitted on 17 Nov 2011

HAL is a multi-disciplinary open access archive for the deposit and dissemination of scientific research documents, whether they are published or not. The documents may come from teaching and research institutions in France or abroad, or from public or private research centers.

L'archive ouverte pluridisciplinaire **HAL**, est destinée au dépôt et à la diffusion de documents scientifiques de niveau recherche, publiés ou non, émanant des établissements d'enseignement et de recherche français ou étrangers, des laboratoires publics ou privés.

Measurements for fuel reforming for scramjet thermal management and combustion optimization : 2009 status of the COMPARER project.

Gregory. ABRAHAM¹, Nicolas GASCOIN^{*}, Stephane. BERNARD[†], Philippe GILLARD[‡],
Orleans University, Laboratoire PRISME - 63, rue de Lattre de Tassigny - 18020 Bourges Cedex

Marc BOUCHEZ[§], Julien BERTRAND^{**}, Bruno LE NAOUR^{††},
MBDA-France, 8 rue Le Brix, 18020 Bourges Cedex, France

I. Introduction

Hypersonic flight is expected to be achieved with dual-mode-Ramjet (Ramjet under Mach 6 and Scramjet beyond) because of its high specific impulse and its capability to be reusable (especially interesting for space transportation)¹, but one of the main issues at these flight conditions is the thermal management of the engine and the vehicle. Different cooling strategies have been evaluated by MBDA-France (calculations, material tests). Metallic panels have been tested as CMC composite ones (C/SiC for instance)², which seem to be promising. But even CMC materials could not withstand such large heat loads (for example, total temperature of external air reaches 2000 K at Mach 7 and combustion add more energy as the inner part of the engine cannot be radiatively cooled). Consequently an active cooling system has to be used but not a dedicated one because it would increase the vehicle weight. Furthermore, another issue occurs under these flight conditions. The time allocated to mix the injected fuel with inlet air, to ignite the combustion and to complete it before the chamber outlet is about 1 ms. These two points lead to the so-called "regenerative cooling" solution : using the fuel to cool down the engine's wall and then burning it in the engine. The fuel is injected in a composite channel (which surrounds the engine) near the outlet of the combustion chamber, it flows to the injection on the opposite way of the burned gases. For "moderate" hypersonic flight Mach numbers (below Mach 8), a heavy hydrocarbon fuel is often chosen here because of its high density compared to cryogenic fuels (800 kg.m⁻³ instead of 70/80 kg.m⁻³ for cryogenic hydrogen, with a specific impulse of liquid hydrocarbon halved)³. When heated and pyrolysed, it produces lighter hydrocarbons species that are considered as more energetic and easier to ignite. This point allows responding to rapid phenomenon in the combustion chamber.

But this cooling system requires knowing firstly how the fuel is decomposed and ensures the cooling and secondly how it will burn in the combustion chamber (to manage the thrust). It has to be noticed that due to the expected high pressure in the cooling loop (>3 MPa) the fluid becomes supercritical in the channel, which leads to some modelling difficulties (fluid properties and flow rate measurement) for the cooling study. The injected flow rate is expected to be slightly different from the one pumped out of the tank because a carbon deposit (coke) could appear at high temperature (above 1000 K) and because a limited transpiration cooling is generally planned to be used through the mastered porosity of the C/SiC wall. This phenomenon will also change the carbon/hydrogen ratio of the fuel in the channel. The points need to be studied because it influences the combustion and *a priori* the thrust.

* Researcher, PhD, AIAA Member.

† Researcher,

¹ PhD student,

‡ University Professor.

§ Aerospace engineer, AIAA Member, AAAF Associate fellow, corresponding author.

** Apprentice-engineer,

†† Aerospace engineer, AIAA Member.

In addition to the long established cooperation with ONERA^{4 5} on this topic, MBDA launched two small-scale programs in collaboration with French laboratories and universities⁶. The present paper presents the status of one of them : the COMPARER project.

II. Future measurements for hydrocarbon-cooled reactive systems

A. Presentation of the COMPARER project

COMPARER is the French acronym for " Control and Measure of PArameters in a REacting stReam". The aim of this project is to identify one or two characteristic parameters (able to be measured) needed to understand and control the complex phenomena involved in the presented cooling technology and to evaluate some associated sensors.

The different actors of this program are MBDA-F, and the University of Orleans, thanks to the PRISME laboratory (formerly the "Laboratoire Energétique, Explosions et Structures" (LEES, explosions dynamics and reactive systems laboratory), the "Laboratoire Vision et Robotique" (LVR, vision and robotics laboratory)) and the "Pôle Capteurs & Automatismes" (excellence centre for sensors and control), all located in Bourges, in France.

The target is to define and to evaluate, by means of calculation and of experimentation, one or two innovating technologies for the measurement of characteristic parameters of a heated hydrocarbon at high temperature (mass flow rate, specific chemical species).

These measurement techniques will eventually be used for experimental engines (for example for ground testing during development phase of hydrocarbon-cooled system) as well as in flight systems.

If primary applications are regeneratively hydrocarbon cooled engines such as dual-mode ramjets, the techniques could be used for the measurement and the control of any system dealing with heat exchanges and hot/decomposed hydrocarbons : fuel cells for example.

Besides these applications, the COMPARER project gives the opportunity to increase the scientific data and enhance the cooperation at scientific level on several dedicated topics with other laboratories or research institutes.

After the first phase (COMPARER-1)⁷ had finished its 3 years , the second phase COMPARER-2 began in October 2006, also for 3 years.

III. A well documented experiment to investigate possible measurement systems

A. The COMPARER test bench

In order to identify the possible and interesting control measurements, some generic engines were studied in steady conditions, and the different parts of the coupling cooling/burning loop was analyzed with pluridisciplinary, simplified but unsteady approach.

This sensitivity analysis allowed us, in the first phase, to headline critical parameters and to develop strategies to implement the measurement of those parameters in a real engine.

The next step of this program was to build a research test bench (Figure 1) that will enable the development and calibration of specific sensors that could be used for the on-board regulation of a DMR.

The combustion heating of the cooling circuit is simulated thanks to a high temperature oven.

The cooling channel is reduced to a single cylindrical chemical reactor with different possible geometries and materials.

The future measurement system is evaluated at the exit of the tube , outside of the oven.

The combustion process is today simulated by a cold academic burner that allows to burn the non-condensed part of the decomposed-then-cooled hydrocarbon fluid.

Many test series were conducted with liquid dodecane, some test were done with pure hydrocarbon gases.

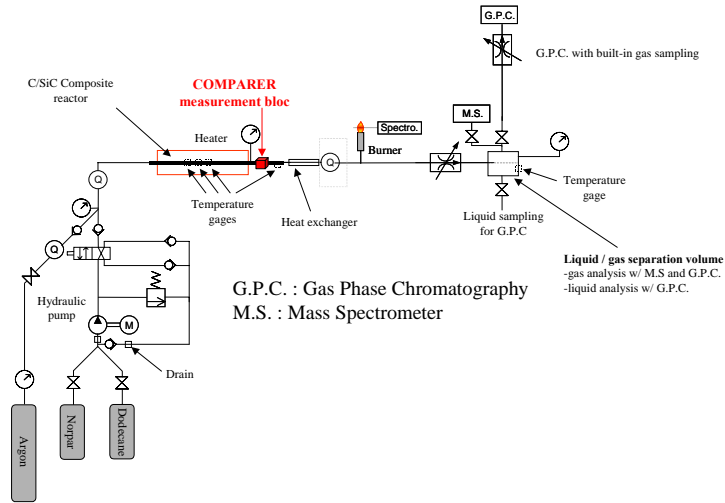

Figure 1. COMPARER test bench sketch (initial)

The fuel is flowing through a metallic or ceramic reactor installed in a high temperature oven (up to 1800 K) and then passes through a measurement prototype block, then is cooled and burnt in an academic flame.

This working bench will be used to validate the unsteady model of the engine and to evaluate different real time measurement techniques on the decomposed fuel : mass flow, decomposition level and capacity to burn.

The identified techniques can be tested on laboratory level on the fuel, at the exit of the reactor (located as "COMPARER measurement bloc" in Figure 1), with steady or unsteady conditions (temperature, fuel mass flow rate, etc). At least for steady operating points, some characterization is planned both on the decomposition of the fuel and on the academic burner, in order to analyze the COMPARER real time measurements.

Due to security and sizing consideration, the fuel mass flow rate in this reactor will be very low (0.05 to $0.5 \text{ g}\cdot\text{s}^{-1}$) This way, the burner power at the end of the line is limited to 5 kW and a real time spectroscopy could be used as the combustion diagnostic device.



Figure 2 : general view of COMPARER test bench (initial – left ; modified with FTIR – right)

B. Characterization of the hydrocarbon content at the exit of the oven.

A thermocouple can be implemented in the flow at the exit of the oven, upstream the "measurement block".

The main diagnostic method on this test bench is the Gas Phase Chromatography coupled to a Mass Spectrometer. Those two methods will be used to cross-checked the results obtained with the future COMPARER sensors.

After the water-cooled heat exchanger, the hydrocarbon compound cooled at roughly 30°C is separated : the gaseous products are analysed by the CDG (varian CP 3800) while the condensed products are collected and analysed with a dedicated GC/M.S. device (Agilent).

The gaseous products can now also be measured with FTIR, in steady state or unsteady conditions.

The figures below show examples of results of these analysis for gaseous and liquid products, while the maximum temperature in the oven (and then the maximum fluid temperature) is increased.

The mass fractions are given referred to the phase proportion, the liquid phase is continuously decreasing with the temperature, while the decomposition rate is increasing.

A first example is given for a test campaign obtained with automatic control of the dodecane pressure (1 MPa) with a mass flow of 0,05 g.s⁻¹ in a tube of 4.5 mm internal diameter in stainless steel 316 L

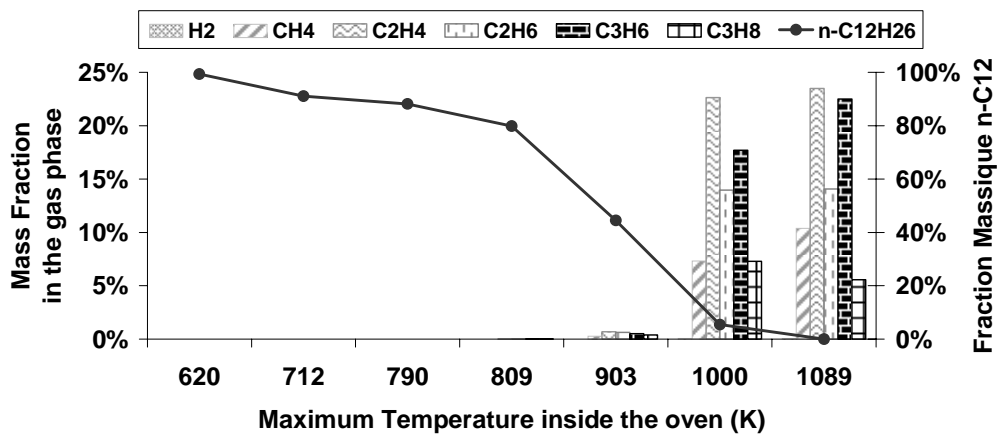

Figure 3 : example of the analysis of the gaseous products

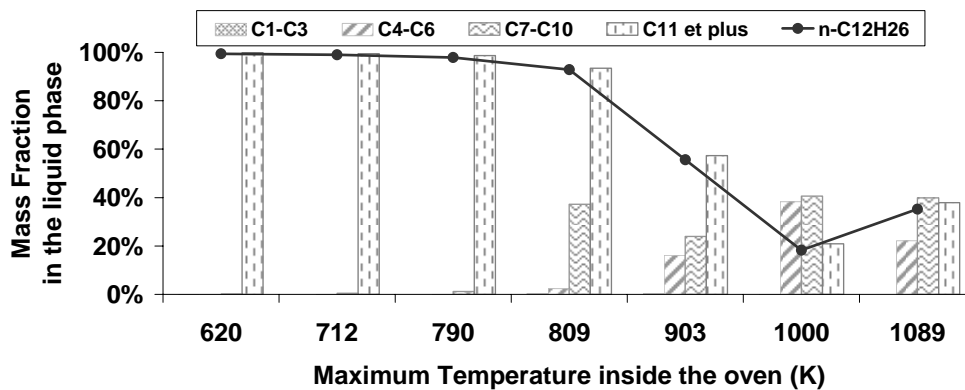

Figure 4 : example of the analysis of the liquid products

In order to limit the coking difficulties (typical hot duration of one COMPARER experimental survey is 4 hours), a titane tube is preferably used to 316L one.

The COMPARER test bench was modified and enhanced in the phase 2 of the program.⁸

After investigation of different materials for the reactor tube, the basis for COMPARER experiment is the use of a titanium tube : the coking is then drastically limited, allowing to operate with high decomposition during several hours, according to the main target of the program : develop and test new measurement methods.

Different fuels were investigated : dodecane (reference fuel), regular aviation kerosene, heptane, ...
 One example of the pyrolysis level of the fuels is shown below, as a function as the maximum temperature of the oven.

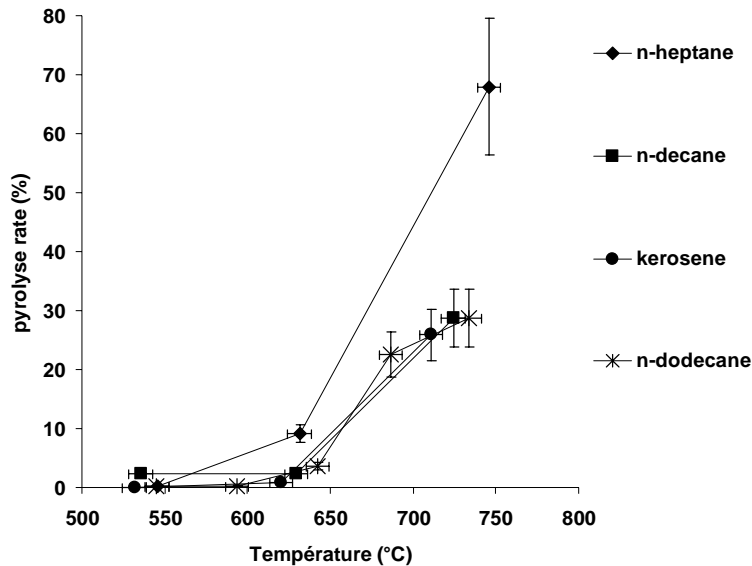

Figure 5 : comparison of the decomposition level of different fuels in the same COMPAREX experiment

As expected, decane and dodecane have quite similar results, and are comparable to the regular kerosene (dodecane is used as a surrogate of kerosene in many studies, under the COMPAREX experiment conditions this possibility is confirmed). Heptane was found to have a quite different behavior, the big difference observed would have to be confirmed quantitatively by additional experiments and by numerical simulations.

The GC/MS measured composition is mostly the same for dodecane, decane and kerosene, and is quite different for the heptane. The figure below shows the measured mass fractions of H₂ and CH₄ as an example.

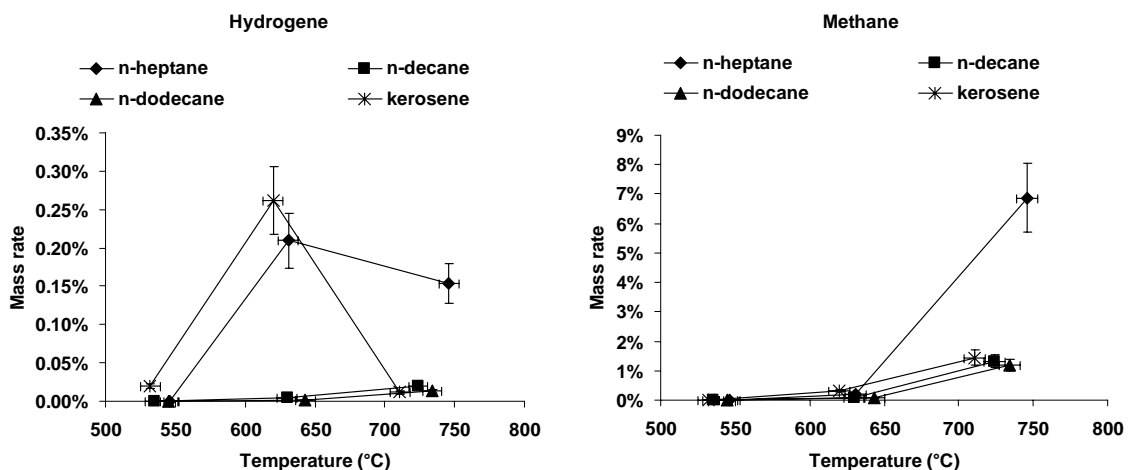

Figure 6: H₂ and CH₄ mass fractions as a function of the maximum oven temperature

The part of H₂ is low, then the measurement accuracy is probably questionable.

FTIR systematic on line measurement and after-test identification was made on the non condensed phase of the decomposed fuel. This method is discussed later.

The 1D thermal analysis help to understand the effect of the temperature field in the oven as well as to compute the residence time along the tube, while the density and then the fuel speed is continuously and drastically changing. In thermal steady state, computational results presented below were made with the NANCY MBDA-in-house semi-empirical code, coupled with detailed finite rate chemistry model of dodecane pyrolysis.

In the figure, the oven temperature assumed in in red (Tfour), the computed fuel temperature (Temp fluide) is in pink.

The computed molar fraction of dodecane is decreasing after 500 mm, represented in dark blue.
The abscissa is the distance in the reactor implemented in the oven.

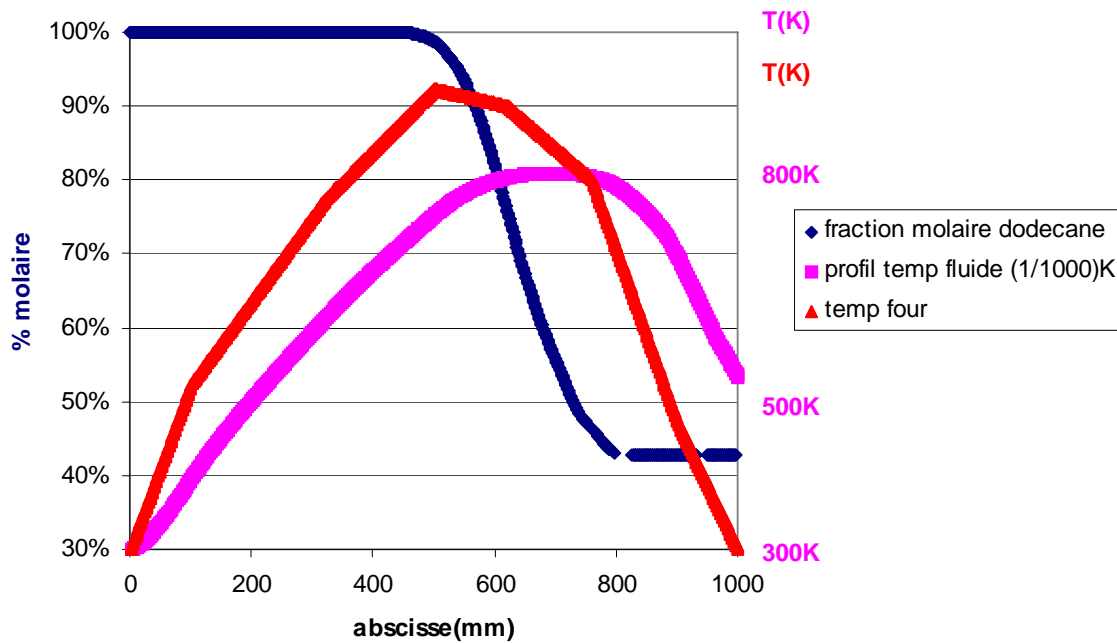

Figure 7 : computed C12H26 molar fraction (left) and temperatures (tube, fluid) (right) for COMPARER experiment : oven at 650°C - 0.05 g/s at 60 bar in titanium tube

In the last part of the oven, the fluid begins to be cooled down and the molar fraction of the initial product is then again constant.

The decomposition level can be correctly predicted by the numerical model (NANCY coupled with detailed kinetic model of dodecane pyrolysis), despite the uncertainty on the temperature of the external surface of the tube.

Table 1 : numerical analysis of dodecane pyrolysis for 2 test conditions

	Test conditions : oven at 750°C (1023 K)				Test conditions : 650°C	
	NANCY	Experim.	NANCY	NANCY	nancy	Expé
Températures tube externe Expérimental/NANCY	1074 K assumed	750°C (+/- 50°)	1048K assumed	1023 K assumed	923 K assumed	650°C (+/-50°C)
dodecane	66 %	71%	75%	86%	99 %	96 %
Other alcanes	12 %	15 %	8,5%	5 %	0,5 %	2 %
alcenes	13 %	14 %	10 %	5 %	0,7 %	1,5 %
The temperatures below were computed but not measured :						
T max dodecane	818 K	/	811 K	797 K	753,2 K	/
Time of Tmax	55,1 s	/	57,4 s	59,5 s	64.3 s	/
T_outlet dodecane	673 K	/	661 K	647 K	591 K	/
Total residence time	60,8 s	/	64,3 s	64,5 s	76,6 s	/

IV. Investigation of possible operational measurement techniques

A. Introduction

As previously mentioned, the COMPARER project aims to investigate some measurements techniques that could be used for quick analysis of an actual complex system, on ground or in flight.

The possible techniques are first evaluated by computations, with the existing models. If they appear interesting, the COMPARER test bench is used to evaluate them experimentally.

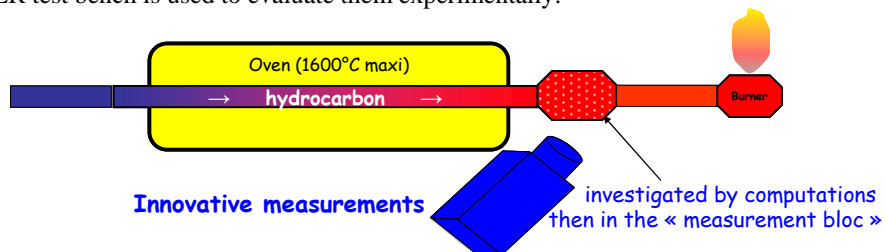

Figure 8 : principle of test of "innovative instrumentation" on COMPARER

The "measurement bloc" is a modular stainless steel system with thermocouples, optical or mechanical access.

It can be isolated from external natural cooling or temperature-stabilized thanks to heating wires.

Many different measurements have been investigated, that are in principle usable for qualifying the decomposed hydrocarbon fuel. Some of them are detailed in ⁹. The present paper gives some information on the IR methods that were particularly investigated in the second phase of the COMPARER program.

B. Predicting the fuel burning capability : possible use of IR signal on the decomposed fuel

Giving the fact that temperature is the first parameter governing the decomposition of hydrocarbons fuel, this parameter could be sufficient to know the pyrolysed mixture composition before injection in the combustion chamber. But to control the scramjet in terms of thrust, it is needed to predict how the injected fuel can burn. A criterion has to be found to represent the capacity for the mixture to burn. The inflammation delay could be chosen although other criteria like the fundamental flame velocity or the activation energy are of great interest. It can be

chosen that the ignition delay should not be greater than 0.1 ms. It corresponds roughly to a tenth of the combustion chamber length as it is confirmed in the literature¹⁰.

Some preliminary work, with available models, has been performed in order to give a proposal for defining a “burning capability index” of the decomposed fuel⁶.

After a review of the possible measurement methods, passive IR spectroscopy was selected as one of the promising and usable ways.

Some computations of the fuel IR spectrum, as a function of the fuel temperature and composition, have been done with the HITRAN software¹¹. This data bank was used out of its nominal validation: further spectrum measurement have to be done by specialized team on COMPAREER test bench to check the actual spectra of decomposed hydrocarbons at high temperature and pressure, including in supercritical state and with possible heterogeneity.

These HITRAN computations were compared with the laminar flames and ignition delay SENKIN computations.

- Luminance of hot fluids at given wavelength ...

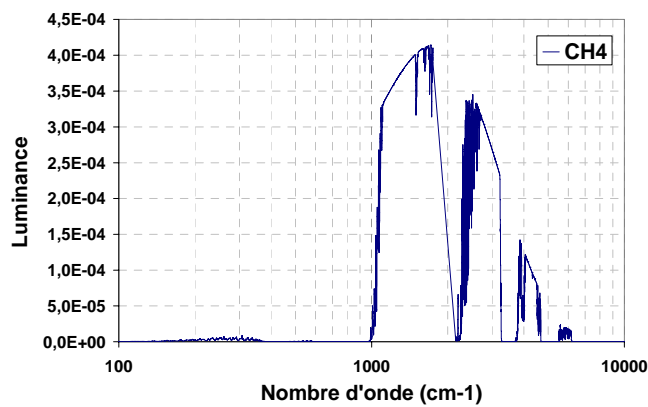

HITRAN 1996 computations

- Ignition delay
- Premix flame.

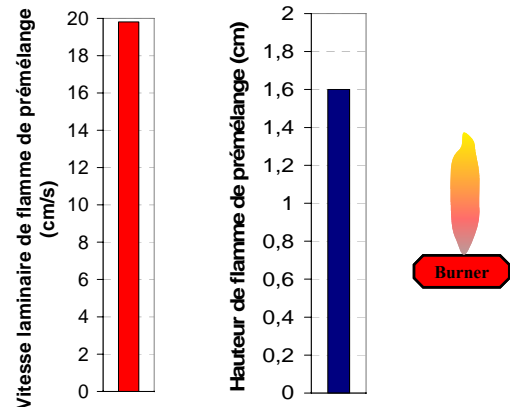

CHEMKIN computations

Figure 9 : preliminary computations of IR signal and possible correlation with combustion index

This theoretical confirmed the potential interest of IR measurement but experimental demonstration had to be done. The COMPAREER test bench is a useful tool for testing the application of narrow-band, real-time IR spectroscopy to fuel analysis for engine control.

First, another laboratory, specialized on spectroscopy, made some measurements of heated gas mixtures to check the feasibility and obtain a first comparison of the existing

Preliminary measurement have been done in 2006/2007 with the LEEE laboratory from Paris X university¹² and compared with available data base (for example HITRAN1996). An example is given below :

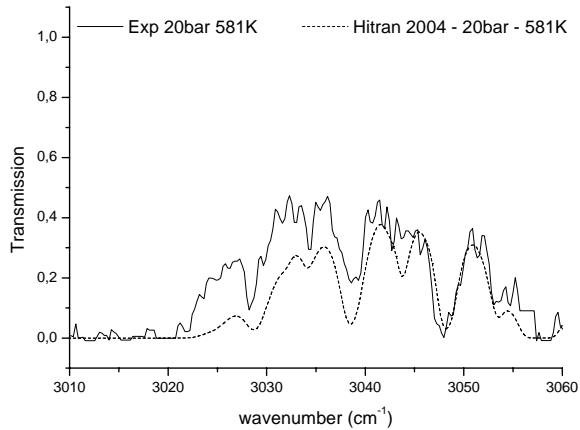
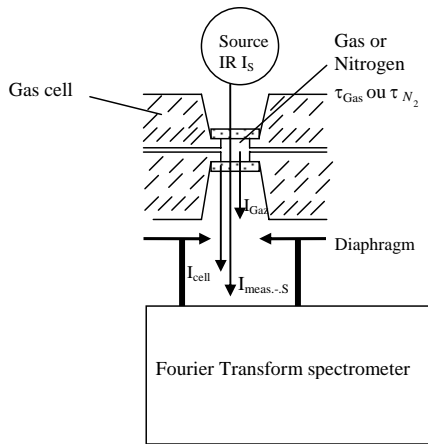

Figure 10 : CH4 IR measurement made by external laboratory on hot CH4 on the COMPARER test bench ¹²

.After this first academic investigation, an important effort was made to obtain on line FTIR measurement for all the performed experiment, using a dedicated FTIR and different paths and cells, allowing to measure spectrum of gas phase or of the complete supercritical hot fuel. Spectra obtained with through the optical access of the “measurement bloc” with heated gases and dodecane have been analysed by the COMPARER team.

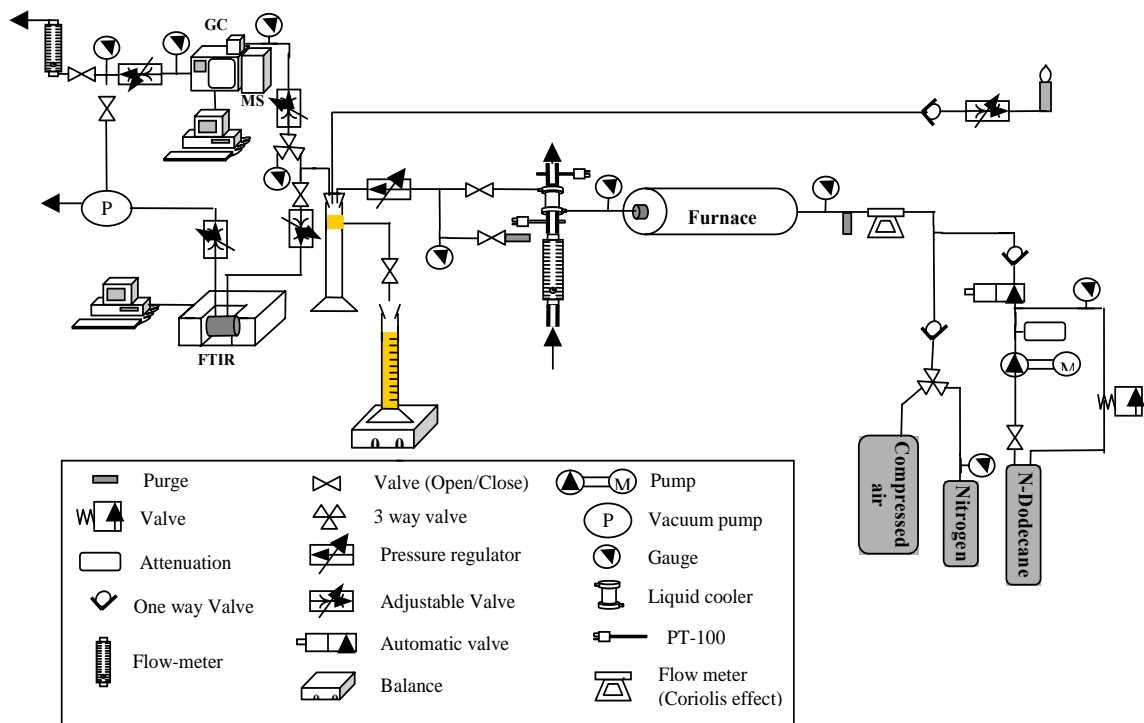

Figure 11 : enhanced COMPARER test bench (here with FTIR on gas phase)

An example of the variation of the chemical species computed from the FTIR signal acquired during experiment time is given below: different levels of temperature are successively studied during the same experiment.

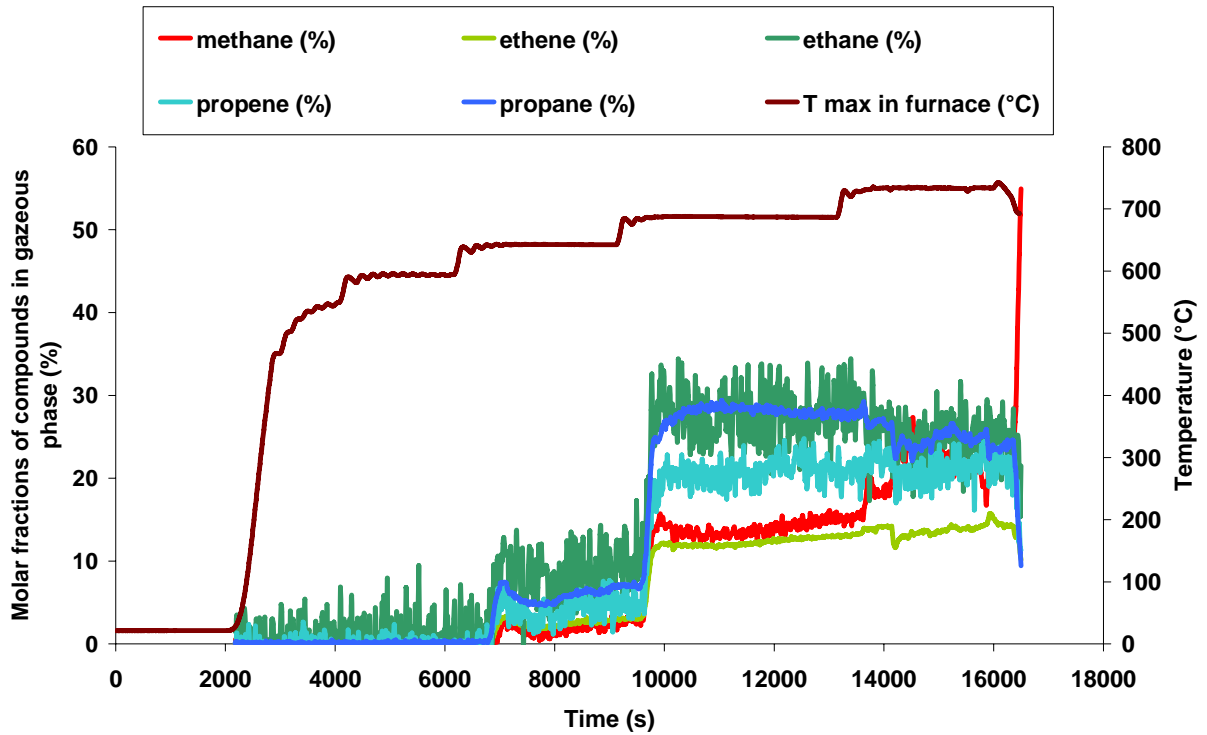

Figure 12 : Molar fractions evolution of compounds in gaseous phase at ambient conditions given by the FTIR and maximum temperature in the furnace during a pyrolysis of n-dodecane (titanium reactor, 60 bar, 0.1 g/s)

The composition obtained from FTIR analysis can be close to the GC/SM measured one. Different inverse methods were used during the COMPAREER program.

An example is shown below for one of the IR identification method, on ethane, ethane, propane and methane.

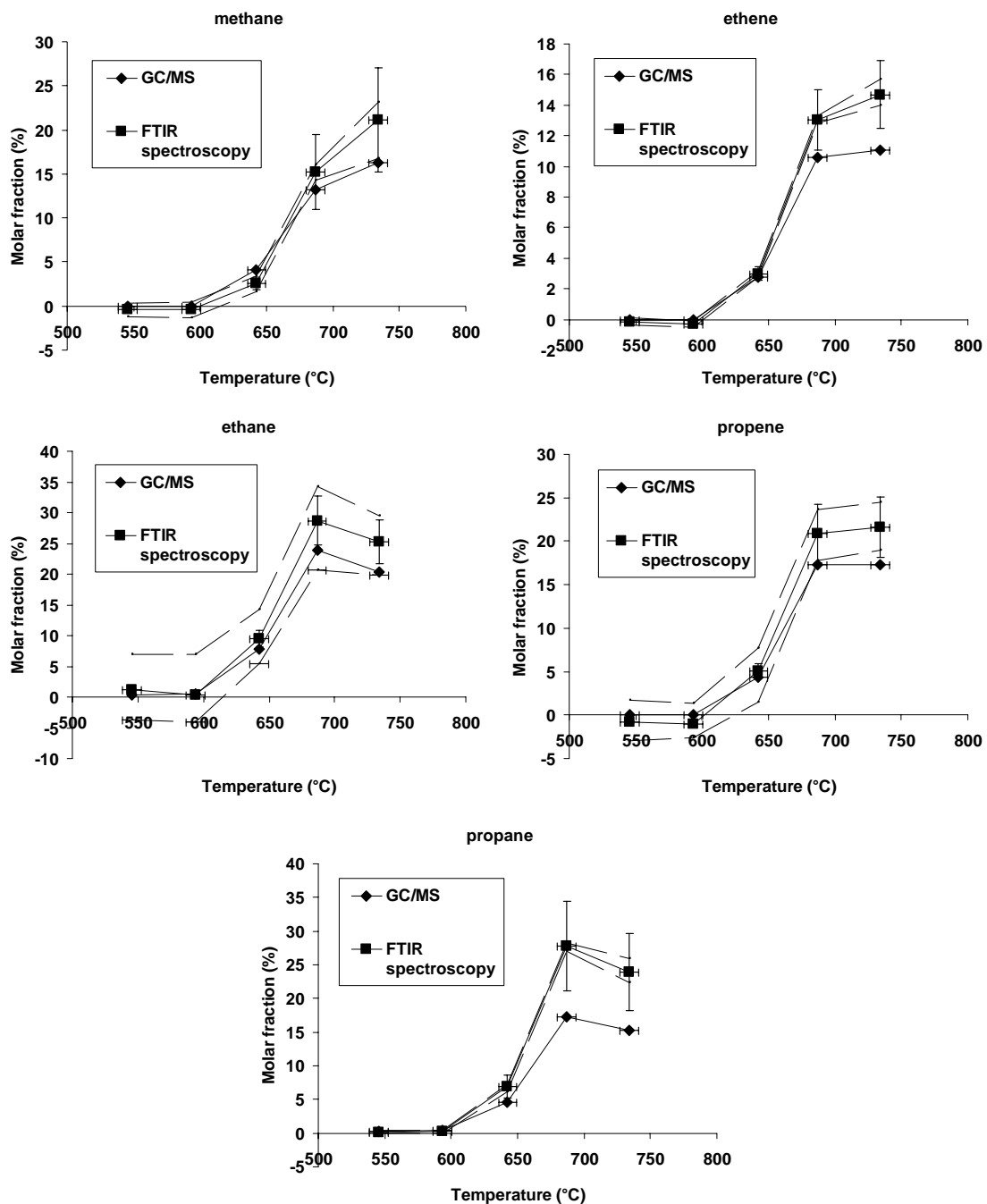

Figure 13 : example of decomposed products from IR or Gas Chromatography

The FTIR method was used for all the fluid tested and gives correct results.

The relative error of molar concentration observed for different species of pyrolysis of different fuels is given on the figure below. It is calculated between the measure given by GC/MS and the measure given by the FTIR method. The form of the point represent the hydrocarbon used, and the color the species analysed. A limit of fiability has been established at 4% of molar fraction. Before this value, the relative error is too high and can reach more of

100%. Over this value the relative error is include between 0% and 40% and the absolute error is under 5%, except for the propane. Moreover, when the molar fraction increase, the relative error decrease.

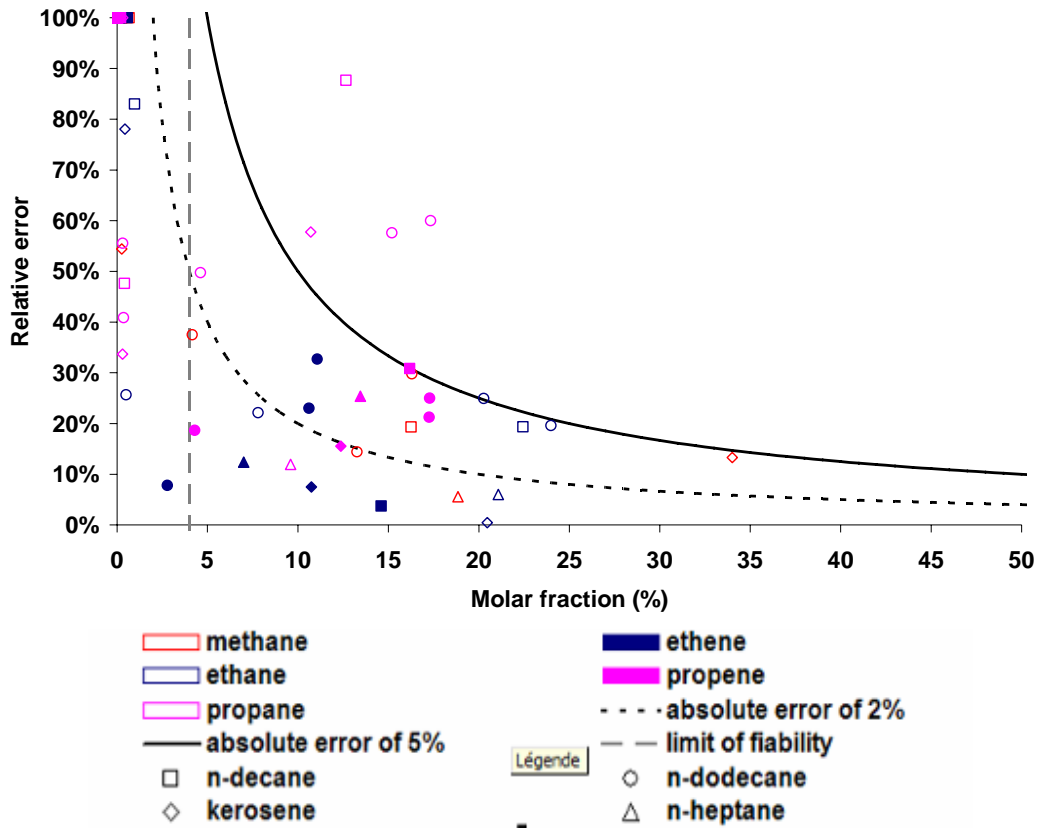

Figure 14 : estimation of the error of the FTIR method for different fuels

The FTIR method is confirmed to be usable for in-flight application (GC/MS cannot be used for real-time monitoring for flight application). The choice of the frequencies, the type of spectral bands (local, narrow, ...) will be done depending on the system need, as it was investigated in the first part of the COMPARER program⁶ (example of Figure 9).

Acknowledgments

The COMPARER present work has been realised with the contribution of the "Conseil Général du Cher (18)", of the "Conseil Régional du Centre", of the FRED, of the FEDER, of the FSE and of MBDA-France. The good evolution of the COMPARER project was made possible thanks to the contribution of Mr. Yves Parmantier, person in charge of the project and coordinator of the "Pôle Capteurs et Automatismes" of Bourges, which carried the project until its effective beginning.

References

-
- ¹ F. Falempin, D. Scherrer, G. Laruelle, Ph. Rostand, G. Fratacci, J.L.Schultz, "French hypersonic propulsion program PREPHA -results, lessons & perspectives", *AIAA - 98 - 1565 – Norfolk, November 1998*.
- ² Bouchez, M., and Beyer, S., "PTAH-SOCAR fuel cooled composite material structure for dual mode ramjet and liquid rocket engine – 2005 status", *AIAA-2005-3434*.
- ³ Giraudot, T., Massot, A., Boselli, L., and Talbot, B., "Dual-fueled advanced high-speed ramjets : students paper", *AIAA-2002-5214, Orléans, France, October 2002*.
- ⁴ Serre, L., Falempin, F., "PROMETHEE : The French military hypersonic propulsion Program", *AIAA-2002-5141*.
- ⁵ Daniau, E., and Sicard, M., " Experimental and numerical investigations of an endothermic fuel cooling capacity for scramjet application ", *AIAA-2005-*.
- ⁶ Daniau, E. , Bouchez, M. Herbinet, O., Marquaire, P.M., Gascoin, N., Gillard, P., « Fuel reforming for scramjet thermal management and combustion optimization”, *AIAA-2005-3403*.
- ⁷ N. Gascoin, P. Gillard, S. Bernard, Y. Touré, E. Daniau, E. Dufour, M. Bouchez, "Transient Numerical Model of Scramjet Active Cooling, Application to an Experimental Bench", 4th International Energy Conversion Engineering Conference and Exhibit (IECEC), 26-29 June 2006, San Diego, USA
- ⁸ N. Gascoin, P. Gillard, S. Bernard, E. Daniau, M. Bouchez, « Pyrolysis of supercritical endothermic fuel: evaluation for active cooling instrumentation”, *International Journal of Chemical Reactor Engineering*, Article A7, Vol. 6, The Berkeley Electronic Press, 2008.
- ⁹ N. Gascoin et al., “Characterization of supercritical reactive flow for hypersonic real-time application”, *AIAA-2009-7375*, Breme, Germany, October, 2009
- ¹⁰ Buriko, Y., Vinogradov, V., Goltsev, V., Waltrup, P.J., "Influence of Active Radical Concentration on Self-Ignition Delay of a Propane/Air Mixture", *AIAA 2001-3958 (2001)*.
- ¹¹ Rothman L. S. et al., "The Hitran Molecular Spectroscopic Database And Hawks (Hitran Atmospheric Workstation): 1996 Edition", *J. Quant. Spectrosc. Radiat. Transfer, Vol. 60, No. 5, (1998) 665-710*.
- ¹² P. Vasseur et al., “Measurement of Infrared CH4 lines at 2 - 48bar and 300 - 785K”, to be published.