



**HAL**  
open science

## Fault tolerant control for nonlinear systems subject to different types of sensor faults

Dalil Ichalal, Benoît Marx, Didier Maquin, José Ragot

► **To cite this version:**

Dalil Ichalal, Benoît Marx, Didier Maquin, José Ragot. Fault tolerant control for nonlinear systems subject to different types of sensor faults. PAPHYRUS Workshop on Fault Diagnosis and Fault Tolerant Control in large scale processing industries, Oct 2011, Porticcio, Corse, France. pp.CDROM. hal-00639357

**HAL Id: hal-00639357**

**<https://hal.science/hal-00639357v1>**

Submitted on 8 Apr 2014

**HAL** is a multi-disciplinary open access archive for the deposit and dissemination of scientific research documents, whether they are published or not. The documents may come from teaching and research institutions in France or abroad, or from public or private research centers.

L'archive ouverte pluridisciplinaire **HAL**, est destinée au dépôt et à la diffusion de documents scientifiques de niveau recherche, publiés ou non, émanant des établissements d'enseignement et de recherche français ou étrangers, des laboratoires publics ou privés.

# Fault tolerant control for nonlinear systems subject to different types of sensor faults

Dalil Ichalal \* Benoît Marx \*\* Didier Maquin \*\* José Ragot \*\*

\* *IBISC Laboratory, Evry-Val d'Essonne University,  
40, rue de Pelvoux, Courcouronnes 91020 Evry Cedex  
e-mail: dalil.ichalal@ibisc.fr*

\*\* *CRAN, UMR 7039, Nancy-University – CNRS  
2, avenue de la forêt de Haye, 54016 Vandœuvre-lès-Nancy Cedex  
e-mail: {benoit.marx, didier.maquin, jose.ragot}@ensem.inpl-nancy.fr*

---

**Abstract:** This paper deals with the problem of fault tolerant control of nonlinear systems represented by Takagi-Sugeno models subject to sensor faults. Observer-based controllers are designed for each faulty-situation (mode). The classical switching law is replaced by a new mechanism which avoids the switching phenomenon. The purpose is to be able to study the stability of the global closed-loop system. This new mechanism uses the residual signals obtained by a residual generator. A bank of observers is designed and each observer uses only one output. Each observer based controller is designed using the estimated state provided by the corresponding observer. Finally, the control law is constructed from these different controllers by using smooth weighting functions depending on the residual signals and satisfying the convex sum property. This last allows to study the stability of the closed-loop system by Lyapunov theory and the tools developed for Takagi-Sugeno systems. LMI conditions are then proposed to ease the design of a such fault tolerant controller.

---

## 1. INTRODUCTION

Diagnosis issues are becoming very important to ensure a good supervision of the systems and guarantee the safety of human operators and equipments, even if systems are becoming more and more complex. If a fault occurs, it is important to reconfigure the control law in order to preserve the stability and the performances of the system.

Since many years, linear models have been largely studied and many theories and methods have been developed for linear systems in the fields of fault diagnosis and fault tolerant control [Patton et al., 1989, Gertler, 1998, Korbicz et al., 2004, Isermann, 2007, Ding, 2008]. However, the linearity assumption is only verified around a single operating point. In order to consider a large operating range of the system, it is important to take into account the nonlinearities in the modeling tasks. The obtained models are more accurate than linear ones but are obviously also harder to deal with. Indeed, due to the complexity of nonlinear systems, there is no general framework of study as in the case of linear systems. Consequently, it leads to work on specific classes of models, for example, Lipschitz systems, LPV systems, bilinear systems, etc.

Among the several classes of nonlinear systems, Takagi-Sugeno (T-S) models have been introduced in [Takagi and Sugeno, 1985]. The interest of this structure is the property of "universal approximator". Any nonlinear behavior can be then approximated with a given accuracy with a T-S model [Tanaka and Wang, 2001]. A T-S model is made up of a set of linear submodels and an interpolation mechanism between these submodels based on nonlinear weighting functions. A second important property of this

kind of models is the convex sum property of the weighting functions which allows to extend some of the tools and methods developed for linear systems.

The T-S models have been extensively studied and in various domains. Among them, the problems of modeling and identification are treated in [Gasso, 2000, Orjuela et al., 2008]. T-S models can be established using three main principal methods. The first one is based on the linearization of the system trajectory around different operating points. The optimal weighting functions are then obtained by minimizing the output error between the real system and the model. For more complex systems, a nonlinear analytic model is often difficult to elaborate, so the second method relies on the black box approach. After determining an adequate structure, the system parameters are identified by minimizing the output error between the real system and the T-S model. Finally, if an analytic model exists, the nonlinear sector transformation can be used [Tanaka et al., 1998, Tanaka and Wang, 2001]. The interest of this last method is that the obtained model exactly represents the original nonlinear model. This model may be difficult to study due to the dependence of the weighting functions on the state of the system which is often not fully measurable. However, an adequate choice of the model rewriting can be made in order to ease its use for control or diagnosis [Nagy et al., 2009, 2010].

The problems of stability and stabilization of nonlinear T-S systems are studied in [Tanaka et al., 1996, 1998, Tanaka and Wang, 2001, Chadli et al., 2002, Guerra et al., 2006, Kruzewski et al., 2008], where different approaches are used. Among these approaches, one can cite the use of the Lyapunov theory and the formulation of the sta-

bility conditions in terms of linear matrix inequalities. Quadratic stability has been studied in [Tanaka et al., 1998], but it has been found that finding a common Lyapunov matrix satisfying a set of LMIs is difficult or impossible as well as the number of submodels increases. Then, the polyquadratic and the non-quadratic approaches have been developed in [Johansson, 1999, Tanaka et al., 2003]. These approaches are extended in [Bergsten et al., 2002, Akhenak et al., 2007, 2008, Yoneyama, 2009, Ichalal et al., 2009c,b] for observer design applied to state and unknown input estimation. These observers are used for fault diagnosis in [Chen and Saif, 2007, Marx et al., 2007, Nguang et al., 2007, Akhenak et al., 2008, Ichalal et al., 2009c, Zhao et al., 2009]. The design of fault tolerant control for Takagi-Sugeno systems was also studied. Let us cite the approach of state trajectory tracking proposed in [Ichalal et al., 2010] for actuator faults and the approach using a bank of observer-based controllers with switching mechanism for sensor faults in [Oudghiri et al., 2008].

In this paper, a new approach for fault tolerant control is proposed. It is based on a bank of observers and a bank of controllers. Each observer estimates the state of the system from only one output, then if a fault affects a given sensor, the controller uses the estimated states provided by the other observers. A new mechanism to pass from faulty-controller to others is designed by using nonlinear smooth functions satisfying the convex sum property and depending on residual signals. Finally, the FTC is represented by a mixture of all the local controllers and if a sensor fault is isolated, the corresponding controller is disabled and the FTC becomes a mixture of the local controllers using only estimated states obtained from fault free sensors.

## 2. TAKAGI-SUGENO MODELING

Generally, nonlinear systems are modeled in the following form:

$$\begin{cases} \dot{x}(t) = f(x(t), u(t)) \\ y(t) = h(x(t), u(t)) \end{cases} \quad (1)$$

where  $x(t) \in \mathbb{R}^n$  is the state vector,  $u(t) \in \mathbb{R}^m$  is the control input and  $y(t) \in \mathbb{R}^p$  represents the system output vector. The functions  $f$  and  $h$  are generally nonlinear. This mathematical model can represent any nonlinear behavior but its main disadvantage is its complexity and therefore it is not always adapted to design a controller or an observer. As explained in the previous section, the Takagi-Sugeno model is an interesting alternative to study nonlinear systems.

Using identification, linearization, or the so-called nonlinear sector transformation, a T-S model for the model (1) may be obtained under the form:

$$\begin{cases} \dot{x}(t) = \sum_{i=1}^r \mu_i(\xi(t)) (A_i x(t) + B_i u(t)) \\ y(t) = \sum_{i=1}^r \mu_i(\xi(t)) (C_i x(t) + D_i u(t)) \end{cases} \quad (2)$$

where  $A_i \in \mathbb{R}^{n \times n}$ ,  $B_i \in \mathbb{R}^{n \times m}$ ,  $C_i \in \mathbb{R}^{p \times n}$ ,  $D_i \in \mathbb{R}^{p \times m}$ . The weighting functions  $\mu_i$  are nonlinear and depend on the decision variable  $\xi(t)$  which can be measurable like  $u(t)$  or  $y(t)$  or not measurable like the state of the system  $x(t)$ . In some situations (hybrid or LPV systems for example)

it can also be an external signal. The weighting functions satisfy the convex sum property described by the following constraints:

$$\begin{cases} 0 \leq \mu_i(\xi(t)) \leq 1, \quad \forall t, \forall i = 1, \dots, r \\ \sum_{i=1}^r \mu_i(\xi(t)) = 1, \quad \forall t \end{cases} \quad (3)$$

The multiple model structure provides a mean to generalize the tools developed for linear systems to nonlinear systems due to the properties (3) and to the linearity of the submodels.

## 3. FAULT TOLERANT CONTROL DESIGN FOR T-S SYSTEMS

### 3.1 Preliminary: stabilizing observer-based control

Recently, advanced methods based on Takagi-Sugeno approach were proposed to control nonlinear systems. When the states of the system are not measured, an observer based approach can be used. The control law then depends on the estimated states. Let us consider the nonlinear T-S system given by

$$\begin{cases} \dot{x}(t) = \sum_{i=1}^r \mu_i(\xi(t)) (A_i x(t) + B_i u(t)) \\ y(t) = \sum_{i=1}^r \mu_i(\xi(t)) C_i x(t) \end{cases} \quad (4)$$

Assume that the pairs  $(A_i, B_i)$  are controllable and the pairs  $(A_i, C_i)$  are observable. The commonly used observer-based state feedback control law is given by

$$\begin{cases} \dot{\hat{x}}(t) = \sum_{i=1}^r \mu_i(\xi(t)) (A_i \hat{x}(t) + B_i u(t) + L_i (y(t) - \hat{y}(t))) \\ \hat{y}(t) = \sum_{i=1}^r \mu_i(\xi(t)) C_i \hat{x}(t) \\ u(t) = - \sum_{i=1}^r \mu_i(\xi(t)) K_i \hat{x}(t) \end{cases} \quad (5)$$

Let us define the state estimation error  $e(t) = x(t) - \hat{x}(t)$ . Substituting the control law in both the system and the observer, the dynamics of the closed-loop system and the state estimation error are given by

$$\begin{cases} \dot{x}(t) = \sum_{i=1}^r \sum_{j=1}^r \mu_i(\xi(t)) \mu_j(\xi(t)) ((A_i - B_i K_j) x(t) + B_i K_j e(t)) \\ \dot{e}(t) = \sum_{i=1}^r \sum_{j=1}^r \mu_i(\xi(t)) \mu_j(\xi(t)) (A_i - L_i C_j) e(t) \end{cases} \quad (6)$$

Or in a following compact form using the augmented state vector  $x_a(t) = [x^T(t) \ e^T(t)]^T$

$$x_a(t) = \sum_{i=1}^r \sum_{j=1}^r \mu_i(\xi(t)) \mu_j(\xi(t)) \begin{pmatrix} A_i - B_i K_j & B_i K_j \\ 0 & A_i - L_i C_j \end{pmatrix} x_a(t) \quad (7)$$

The gains  $K_j$  of the controller and those  $L_i$  of the observer are determined in such a way to ensure asymptotic stability of the system (7). Different LMI approaches are provided in recent years to deal with this problem (see for example [Tanaka and Wang, 2001, Tanaka et al., 2003,

Guerra et al., 2006]). In this work, an alternative to these approaches is proposed. The main idea is, firstly, to use the descriptor approach to decouple the product  $B_i K_j$ , this manipulation does not need the use of congruence lemma as used in many works. Secondly, the Lyapunov matrix  $P$  is not assumed to be a block diagonal matrix. As proposed in [Tanaka et al., 2007], the control law can be written in the following form

$$0 \times \dot{u}(t) = - \sum_{i=1}^r \mu_i(\xi(t)) K_i \hat{x}(t) - u(t) \quad (8)$$

Defining the augmented state  $\tilde{x}(t) = [x_a^T(t) \ u^T(t)]$ , the augmented system becomes

$$E \dot{\tilde{x}}(t) = \sum_{i=1}^r \sum_{j=1}^r \mu_i(\xi(t)) \mu_j(\xi(t)) \tilde{A}_{ij} \tilde{x}(t) \quad (9)$$

where

$$\tilde{A}_{ij} = \begin{pmatrix} A_i & 0 & B_i \\ 0 & A_i - L_i C_j & 0 \\ -K_i & K_i & -I \end{pmatrix}, \quad E = \begin{pmatrix} I & 0 & 0 \\ 0 & I & 0 \\ 0 & 0 & 0 \end{pmatrix}$$

*Theorem 1.* The observer based control law (5) ensures asymptotic stability of the system (4), if there exists symmetric and positive definite matrices  $P_1$ ,  $P_5$  and  $P_9$  and gain matrices  $F_i$  and  $M_i$  such that the following constraints hold

$$\begin{aligned} X_{ii} &< 0, \quad i = 1, \dots, r \\ X_{ii} + X_{ji} + X_{ij} &< 0, \quad i, j = 1, \dots, r, i \neq j \end{aligned} \quad (10)$$

where

$$X_{ij} = \begin{pmatrix} \Psi_i & 0 & P_1 B_i - F_i^T \\ * & \Delta_{ij} & F_i^T \\ * & * & -2P_9 \end{pmatrix} \quad (11)$$

$$\Psi_i = P_1 A_i + A_i^T P_1 \quad (12)$$

$$\Delta_{ij} = P_5 A_i + A_i^T P_5 - M_i C_j - C_j^T M_i^T \quad (13)$$

The gains of the observer based controller are derived from the following equations

$$K_i = P_9^{-1} F_i, \quad L_i = P_5^{-1} M_i \quad (14)$$

**Proof.** Consider the quadratic Lyapunov function

$$V(\tilde{x}(t)) = \tilde{x}^T(t) E^T P \tilde{x}(t) \quad (15)$$

where  $P$  is given by

$$P = \begin{pmatrix} P_1 & 0 & 0 \\ 0 & P_5 & 0 \\ 0 & 0 & P_9 \end{pmatrix} \quad (16)$$

Due to the structure of the Lyapunov matrix  $P$  (16) and the symmetry of the positive definite matrices  $P_1$  and  $P_5$ , it obviously follows that  $E^T P = P^T E \geq 0$ . The derivative of  $V$  is described by

$$\dot{V}(\tilde{x}(t)) = \dot{\tilde{x}}^T(t) E^T P \tilde{x}(t) + \tilde{x}^T(t) P E \dot{\tilde{x}}(t) \quad (17)$$

$$= \tilde{x}^T(t) \sum_{i=1}^r \sum_{j=1}^r \mu_i(\xi(t)) \mu_j(\xi(t)) \left( \tilde{A}_{ij}^T P + P^T \tilde{A}_{ij} \right) \tilde{x}(t) \quad (18)$$

After calculation, the negativity of  $\dot{V}(\tilde{x}(t))$  is satisfied if

$$\sum_{i=1}^r \sum_{j=1}^r \mu_i(\xi(t)) \mu_j(\xi(t)) X_{ij} < 0 \quad (19)$$

where  $X_{ij}$  is defined by (11). The negativity of (19) is ensured if  $X_{ij} < 0$ ,  $i, j = 1, \dots, r$ . This result is conservative

as often pointed in literature. To overcome this limitation, the Polya's theorem is applied. Knowing that

$$\left( \sum_{i=1}^r \mu_i(\xi(t)) \right)^q = 1 \quad (20)$$

where  $q$  is a positive integer. The inequality (19) is equivalent to

$$\left( \sum_{i=1}^r \mu_i(\xi(t)) \right)^q \sum_{i=1}^r \sum_{j=1}^r \mu_i(\xi(t)) \mu_j(\xi(t)) X_{ij} < 0 \quad (21)$$

After calculation (i.e. by developing (21) in respect to the weighting functions), relaxed LMI conditions are obtained. Furthermore, if  $q \rightarrow \infty$  asymptotic necessary and sufficient conditions are obtained. (For more details, see Sala and Ariño [2007]). In theorem 1, the proposed LMIs are obtained for  $q = 1$ .

### 3.2 Sensor fault detection and isolation

In the purpose of sensor fault diagnosis, the approach given in [Ichalal et al., 2009a] is adopted. In order to isolate the sensor faults, the residual is generated such that its  $i^{th}$  component is only sensitive to the  $i^{th}$  fault. Then, for a faulty system described by

$$\begin{cases} \dot{x}(t) = \sum_{i=1}^r \mu_i(\xi(t)) (A_i x(t) + B_i u(t)) \\ y(t) = \sum_{i=1}^r \mu_i(\xi(t)) (C_i x(t) + G_i f(t)) \end{cases} \quad (22)$$

where  $f(t) \in \mathbb{R}^p$  denotes the sensor fault, the following residual generator is proposed

$$\begin{cases} \dot{\hat{x}}(t) = \sum_{i=1}^r \mu_i(\xi(t)) (A_i \hat{x}(t) + B_i u(t) + L_i (y(t) - \hat{y}(t))) \\ \hat{y}(t) = \sum_{i=1}^r \mu_i(\xi(t)) C_i \hat{x}(t) \\ r(t) = M (y(t) - \hat{y}(t)) \end{cases} \quad (23)$$

A filter  $W_{ref}$  is introduced to model the desired response of the residual to the fault. The diagonal structure of the matrix transfer function of  $W_{ref}(s)$  allows not only fault detection but isolation. Indeed, the analysis of each component of the residual, i.e.  $r_i(t)$  allows the isolation of the fault affecting the sensor measuring  $y_i(t)$ . The design of the residual generator aims at minimizing the difference between  $\tilde{R}(s) = W_{ref}(s)F(s)$  and  $R(s)$ . This difference is quantified by the  $\mathcal{L}_2$ -gain from  $f(t)$  to  $r(t) - \tilde{r}(t)$ . The block diagonal filter  $W_{ref}(s)$  is defined by

$$W_{ref}(s) = \begin{pmatrix} A_{ref} & B_{ref} \\ C_{ref} & D_{ref} \end{pmatrix} \quad (24)$$

the definition of  $W_{ref}$  can take benefits from an a priori knowledge on the frequency content of the fault. This additional filter must satisfied the condition

$$\sigma_{\min}(W_{ref}(s)) \geq 1 \quad (25)$$

where the function  $\sigma_{\min}(\cdot)$  represents the lowest singular value of the transfer function  $W_{ref}(s)$ . This assumption is made in order to avoid fault attenuation. The design of the gain matrices of the residual generator is performed via the optimization problem given in the theorem 2.

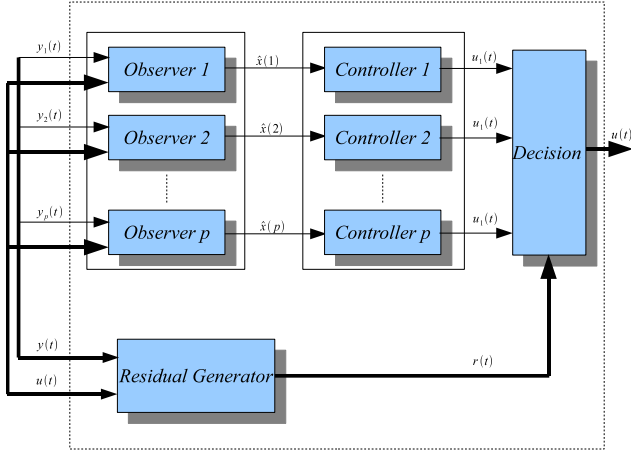

Fig. 1. Fault detection and fault tolerant control block

*Theorem 2.* The robust residual generator (23) exists if there exists symmetric and positive definite matrices  $P_1$  and  $P_2$ , and matrices  $K_i$  and  $M$  solving the following optimization problem

$$\min_{P_1, P_2, K_i, M} \gamma \quad (26)$$

under the following LMI constraints

$$\begin{cases} X_{ii} < 0, & i = 1, \dots, r \\ \frac{2}{r-1} X_{ii} + X_{ij} + X_{ji} < 0, & i, j = 1, \dots, r, i \neq j \end{cases} \quad (27)$$

where, for  $(i, j) \in \{1, \dots, r\}$ ,  $X_{ij}$  and  $\Psi_{ij}$  are defined by

$$X_{ij} = \begin{pmatrix} \Psi_{ij} & 0 & -K_i G_j & C_j^T M^T \\ * & A_{ref}^T P_2 + P_2 A_{ref} & P_2 B_{ref} & -C_{ref} \\ * & * & -\gamma I & G_i^T M^T - D_{ref}^T \\ * & * & * & -\gamma I \end{pmatrix} \quad (28)$$

$$\Psi_{ij} = A_i^T P_1 + P_1 A_i - C_j^T K_i^T - K_i C_j \quad (29)$$

The residual generator gains are obtained by

$$L_i = P_1^{-1} K_i \quad (30)$$

and the attenuation level is given by  $\gamma$ .

The proof is omitted, but, for more details, the reader can refer to [Ichalal et al., 2009a].

### 3.3 Fault tolerant control

In order to achieve the fault tolerant control task, an observer bank is used. The  $j^{th}$  observer is fed with the input of the system  $u(t)$  and the  $j^{th}$  output  $y_j(t)$  as illustrated by the figure 1. Then, this observer can estimate fault-free states even if faults occur on the other sensors. The chosen control law is then given by

$$u(t) = - \sum_{j=1}^r \sum_{k=1}^p h_k(r(t)) \mu_j(\xi(t)) K_j^k \hat{x}^k(t) \quad (31)$$

where  $\hat{x}^k(t)$  is the estimated state vector provided by the  $k^{th}$  observer which uses the  $k^{th}$  output. The control signal  $u(t)$  can be viewed as a blending of the  $p$  observed state feedback controls. The blending is ensured by the functions  $h_k(r(t))$ , which are smooth nonlinear ones satisfying the

convex sum property. The design of such functions is based on the idea that if the  $k^{th}$  sensor is affected by a fault, the residual  $r_k(t)$  is non zero. In this case, the function  $h_k(r(t))$  must be close to zero in order to minimize the influence of  $\hat{x}^k(t)$  affected by the  $k^{th}$  fault. Contrarily to the method proposed in [Oudghiri et al., 2008], based on switched controllers, at each instant the controller is formed by a smooth mixture of all the “local” controllers. Consequently, the stability of the closed-loop system is studied by using the classical approaches developed for Takagi-Sugeno models.

The closed-loop system is then given by the following equations

$$\begin{aligned} \dot{x}(t) &= \sum_{i=1}^r \sum_{j=1}^r \sum_{k=1}^p h_k(r) \mu_i(\xi) \mu_j(\xi) (A_i x - B_i K_j^k \hat{x}^k) \quad (32) \\ &= \sum_{i=1}^r \sum_{j=1}^r \sum_{k=1}^p h_k(r) \mu_i(\xi) \mu_j(\xi) ((A_i - B_i K_j^k) x + B_i K_j^k e^k) \quad (33) \end{aligned}$$

For the sake of simplicity, the time variable  $t$  is omitted. The state estimation error between  $x(t)$  and  $\hat{x}^k(t)$  given the  $k^{th}$  observer is given by  $e^k(t)$  and generated by the the following differential equation

$$\dot{e}^k(t) = \sum_{i=1}^r \sum_{j=1}^r \mu_i(\xi(t)) \mu_j(\xi(t)) (A_i - L_i^k C_j^k) e^k(t) \quad (34)$$

where  $C_j^k$  is the  $k^{th}$  row of the matrix  $C_j$ . Defining the augmented state vector  $x_a^k(t) = [x^T(t) \ e^k(t)]^T$ , the following closed-loop system is obtained

$$\dot{x}_a^k = \sum_{i=1}^r \sum_{j=1}^r \sum_{k=1}^p h_k(r) \mu_i(\xi) \mu_j(\xi) \underbrace{\begin{pmatrix} A_i - B_i K_j^k & B_i K_j^k \\ 0 & A_i - L_i^k C_j^k \end{pmatrix}}_{\Psi_{ijk}} x_a^k \quad (35)$$

The stability of this system is then studied in the same way as proposed in the section 3.1. The gains of the controllers and those of the observers are computed by solving the LMI conditions ensuring the stability of the system (35).

### Algorithm of FTC design

- (1) Construct the residual generator providing the residual signal  $r(t)$  by solving the LMI (27), for  $i, j = 1, \dots, r$ .
- (2) Construct the weighting functions  $h_k(r(t))$  depending on the residual signals.
- (3) Design of the FT controller, by solving the LMI (10) where,  $K_j$  is substituted by  $K_j^k$ , for  $i, j = 1, \dots, r$  and  $k = 1, \dots, p$

**Remark.** An example of possible definition of the functions  $h_i$  is detailed in the example.

## 4. SIMULATION EXAMPLE

To illustrate the proposed approach and the design of the FTC, let us consider the following system represented by two submodels defined by

$$A_1 = \begin{pmatrix} -2 & 1 & 1 \\ 1 & -3 & 0 \\ 2 & 1 & -8 \end{pmatrix}, \quad A_2 = \begin{pmatrix} -3 & 2 & -2 \\ 5 & -3 & 0 \\ 1 & 2 & -4 \end{pmatrix}$$

$$B_1 = \begin{pmatrix} 1 \\ 5 \\ 0.5 \end{pmatrix}, \quad B_2 = \begin{pmatrix} 3 \\ 1 \\ -1 \end{pmatrix}, \quad C = \begin{pmatrix} 1 & 1 & 1 \\ 1 & 0 & 0 \end{pmatrix}$$

Since the second state is measured, the weighting functions are defined by

$$\mu_1(y(t)) = \frac{1 - \tanh(y_2(t))}{2}, \quad \mu_2(y(t)) = 1 - \mu_1(y(t)) \quad (36)$$

An observer-based fault tolerant controller is designed by following the proposed procedure. There are two outputs, then two “local” observer-based controllers are built. A residual generator is also designed in order to generate the two signals detecting and isolating each sensor fault. Finally, the blending mechanism between the two controllers is designed by defining the functions  $h_i(r(t))$  such that  $h_i(r(t))$  is close to zero when  $f_i(t)$  occurs. This can be done by choosing the following smooth functions  $\omega_i$  and the normalized weight  $h_i$ , for  $i = 1, \dots, p$

$$\omega_i(r_i(t)) = \exp(-r_i(t)^2/\sigma_i) \quad (37)$$

$$h_i(r(t)) = \frac{\omega_i(r_i(t))}{\sum_{i=1}^p \omega_i(r_i(t))} \quad (38)$$

For the considered example, the controller is then written as follows

$$u(t) = - \sum_{i=1}^2 \sum_{j=1}^2 h_i(r(t)) \mu_j(\xi(t)) K_j^i \hat{x}^i(t) + ref(t) \quad (39)$$

with  $\sigma_1 = \sigma_2 = 0.01$  and  $ref(t)$  is a given reference signal. Different faults are considered in these simulations: the first ones are additive constant faults, the second ones are additive time varying faults and the last ones are parametric faults.

#### 4.1 Additive constant faults

The considered sensor faults are represented in the figure 3 (top). If a fault occurs on the sensor 1, the decision mechanism minimizes the weight of the controller using the state estimated with the first sensor, this is illustrated by the figure 3 (bottom). The figure 2 illustrates the effectiveness of the proposed approach.

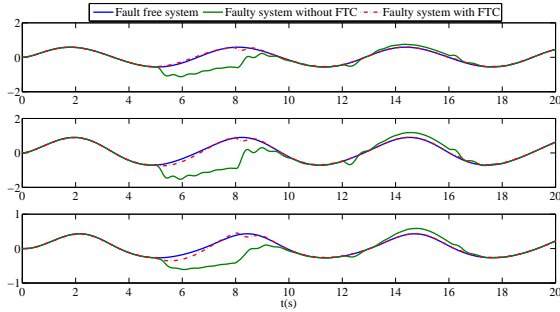

Fig. 2. States comparison

#### 4.2 Additive time varying faults

Let us now consider additive time varying faults. The figures 4 and 5 illustrate the results. The decision functions

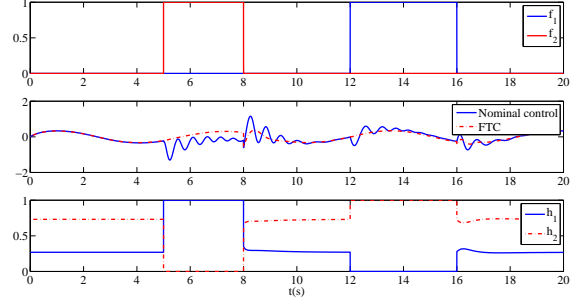

Fig. 3. Faults and control signals

$h_i(r)$  select the controller which is not affected by faults and the system preserve the desired trajectories.

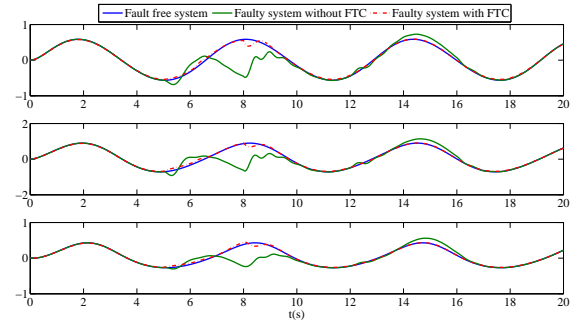

Fig. 4. States comparison

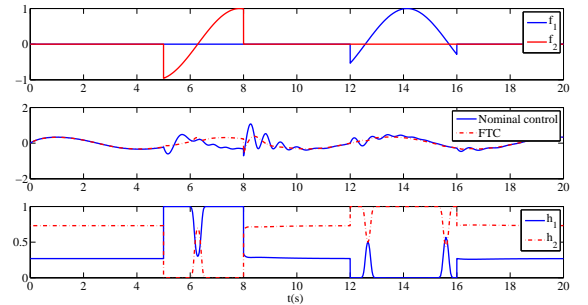

Fig. 5. Faults and control signals

#### 4.3 Sensor parametric faults

Finally, parametric faults affecting the sensors are considered. The faults are as follows

$$y_1(t) = (C_1 + f(t)C_1)x(t) \quad (40)$$

The fault occurs at the time instant 12, It can be seen that the fault tolerant controller compensates the fault by choosing the adequate blending control signal from each controller with the functions  $h_i(r(t))$ . The results are depicted in the figures 6 and 7.

**Remark.** Note that the system is represented in the Takagi-Sugeno’s form with measurable premise variables. In the example, the weighting functions depend on the second output which is affected by the fault. Even if the weighting functions are affected by the fault, the obtained results are acceptable. But, in order to enhance

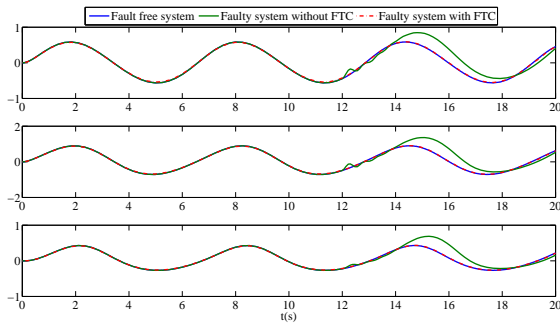

Fig. 6. States comparison

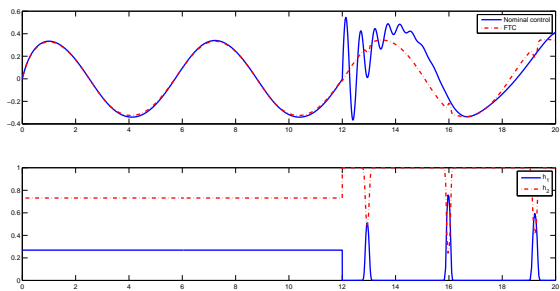

Fig. 7. Faults and control signals

the performances of this approach, it is interesting to use a T-S modeling approach which provides a T-S model with unmeasurable premise variables (states of the system) in order to have a possibility to minimize the effect of faults on the weighting functions of the observers and the controllers.

## 5. CONCLUSIONS

In this paper, a new approach is proposed to design a sensor fault tolerant controller for nonlinear complex systems represented by Takagi-Sugeno model. The approach is based on a bank of observers-based controllers, a residual generator for diagnosis and a smooth selecting mechanism to choose an adequate control signal to compensate the effects of the faults on the system. The stability of the whole system is studied by Lyapunov theory and the LMI constraints are provided to design the gain matrices of different block of the proposed FTC scheme. For future works, it will be interesting to consider the case of T-S systems with unmeasurable premise variables. It is also interesting to study the choice of the functions  $h_i(r(t))$  in order to design the different variables  $c_1$ ,  $c_2$  and  $\sigma$  in order to have an optimal solution for the control signal. Finally, the dedicated scheme for observers-based controllers may have a problem of observability of the state from one or different inputs, it is then interesting to study an other bank, namely the Generalized Observer Scheme.

## REFERENCES

A. Akhenak, M. Chadli, J. Ragot, and D. Maquin. Design of sliding mode unknown input observer for uncertain Takagi-Sugeno model. In *15th Mediterranean Conference on Control and Automation, MED'07*, Athens, Greece, June 2007.

A. Akhenak, M. Chadli, J. Ragot, and D. Maquin. Fault detection and isolation using sliding mode observer for uncertain Takagi-Sugeno fuzzy model. In *16th Mediterranean Conference on Control and Automation, MED'08*, Ajaccio, France, June 2008.

P. Bergsten, R. Palm, and D. Driankov. Observers for Takagi-Sugeno fuzzy systems. *IEEE Transactions on Systems, Man, and Cybernetics - Part B: Cybernetics*, 32(1):114–121, 2002.

M. Chadli, D. Maquin, and J. Ragot. Non quadratic stability analysis of Takagi-Sugeno systems. In *IEEE Conference on Decision and Control, CDC'2002*, Las Vegas, Nevada, USA, December 2002.

W. Chen and M. Saif. Design of a TS based fuzzy nonlinear unknown input observer with fault diagnosis applications. In *American Control Conference*, New York City, USA, July 2007.

S.X. Ding. *Model-based fault diagnosis techniques. Design schemes, algorithms, and tools*. Springer-Verlag, 2008.

G. Gasso. *Identification de systèmes dynamiques non linéaires : approche multi-modèle*. PhD thesis, Institut National Polytechnique de Lorraine (INPL), Nancy, France, 2000. (in French).

J.J. Gertler. *Fault detection and diagnosis in engineering systems*. Marcel Dekker, 1998.

T-M. Guerra, A. Kruszewski, L. Vermeiren, and H. Tirmant. Conditions of output stabilization for nonlinear models in the Takagi-Sugeno's form. *Fuzzy Sets and Systems*, 157(9):1248–1259, 2006.

D. Ichalal, B. Marx, J. Ragot, and D. Maquin. Fault diagnosis in Takagi-Sugeno nonlinear systems. In *7th IFAC Symposium on Fault Detection, Supervision and Safety of Technical Processes, SAFEPROCESS'2009*, Barcelona, Spain, June 2009a.

D. Ichalal, B. Marx, J. Ragot, and D. Maquin. State estimation of nonlinear systems using multiple model approach. In *American Control Conference, ACC'2009*, St. Louis, Missouri, USA, June 2009b.

D. Ichalal, B. Marx, J. Ragot, and D. Maquin. An approach for the state estimation of Takagi-Sugeno models and application to sensor fault diagnosis. In *48th IEEE Conference on Decision and Control, CDC'09*, Shanghai, P.R. China, December 2009c.

D. Ichalal, B. Marx, J. Ragot, and D. Maquin. Fault tolerant control for Takagi-Sugeno systems with unmeasurable premise variables by trajectory tracking. In *IEEE International workshop on Industrial Electronics, ISIE'10*, Bari, Italy, July 2010.

R. Isermann. *Fault-diagnosis systems: An introduction from fault detection to fault tolerance*. Springer, 2007.

M. Johansson. *Piecewise linear control systems*. PhD thesis, Department of Automatic Control, Lund Institute of Technology, Sweden, 1999.

J. Korbicz, J.M. Koscielny, Z. Kowalczyk, and W. Cholewa. *Fault diagnosis: models, artificial intelligence, applications*. Springer, 2004.

A. Kruszewski, R. Wang, and T.M. Guerra. Non-quadratic stabilization conditions for a class of uncertain nonlinear discrete-time T-S fuzzy models: a new approach. *IEEE Transactions on Automatic Control*, 53(2):606–611, 2008.

B. Marx, D. Koenig, and J. Ragot. Design of observers for Takagi-Sugeno descriptor systems with unknown inputs

- and application to fault diagnosis. *IET Control Theory and Application*, 1(5):1487–1495, 2007.
- A.M. Nagy, G. Mourot, B. Marx, G. Schutz, and J. Ragot. Model structure simplification of a biological reactor. In *15th IFAC Symposium on System Identification, SYSID'09*, Saint Malo, France, July 2009.
- A.M. Nagy, G. Mourot, B. Marx, J. Ragot, and G. Schutz. Systematic multimodeling methodology applied to an activated sludge reactor model. *Industrial and Engineering Chemistry Research*, 49(6):2790–2799, 2010.
- S.K. Nguang, P. Shi, and S.X. Ding. Fault detection for uncertain fuzzy systems: An LMI approach. *IEEE Transactions on Fuzzy Systems*, 15(6):1251–1262, 2007.
- R. Orjuela, B. Marx, J. Ragot, and D. Maquin. State estimation for non-linear systems using a decoupled multiple model. *International Journal of Modelling, Identification and Control*, 4(1):59–67, 2008.
- M. Oudghiri, M. Chadli, and A. El Hajjaji. Robust observer-based fault tolerant control for vehicle lateral dynamics. *International Journal of Vehicle Design*, 48(3-4):173–189, 2008.
- R. Patton, P. Frank, and R. Clark. *Fault diagnosis in dynamic systems: Theory and application*. Prentice Hall international, 1989.
- A. Sala and C. Ariño. Asymptotically necessary and sufficient conditions for stability and performance in fuzzy control: Applications of Polyá's theorem. *Fuzzy Sets and Systems*, 158(24):2671–2686, 2007.
- T. Takagi and M. Sugeno. Fuzzy identification of systems and its applications to modeling and control. *IEEE Transactions on Systems, Man, and Cybernetics*, 15(1):116–132, 1985.
- K. Tanaka and H.O. Wang. *Fuzzy control systems design and analysis: A linear matrix inequality approach*. John Wiley and Sons, 2001.
- K. Tanaka, T. Ikeda, and H.O. Wang. Robust stabilization of a class of uncertain nonlinear systems via fuzzy control: quadratic stabilizability,  $H_\infty$  control theory, and linear matrix inequalities. *IEEE Transactions on Fuzzy Systems*, 4(1):1–13, 1996.
- K. Tanaka, T. Ikeda, and H.O. Wang. Fuzzy regulators and fuzzy observers: Relaxed stability conditions and LMI-based designs. *IEEE Transactions on Fuzzy Systems*, 6(2):250–265, 1998.
- K. Tanaka, T. Hori, and H.O. Wang. A multiple Lyapunov function approach to stabilization of fuzzy control systems. *IEEE Transactions on Fuzzy Systems*, 11(4):582–589, 2003.
- K. Tanaka, H. Ohtake, and H. O. Wang. A descriptor system approach to fuzzy control system design via fuzzy lyapunov functions. *IEEE Transactions on Fuzzy Systems*, 15(3):333–341, 2007.
- J. Yoneyama.  $H_\infty$  filtering for fuzzy systems with immeasurable premise variables: an uncertain system approach. *Fuzzy Sets and Systems*, 160(12):1738–1748, 2009.
- Y. Zhao, J. Lam, and G. Huijun. Fault detection for fuzzy systems with intermittent measurements. *IEEE Transactions on Fuzzy Systems*, 17(2):398–410, 2009.