



HAL
open science

Searching for meteor ELF /VLF signatures

J.-L. Rault

► **To cite this version:**

| J.-L. Rault. Searching for meteor ELF /VLF signatures. WGN, 2010, 38, pp.67-75. hal-00638548

HAL Id: hal-00638548

<https://hal.science/hal-00638548>

Submitted on 5 Nov 2011

HAL is a multi-disciplinary open access archive for the deposit and dissemination of scientific research documents, whether they are published or not. The documents may come from teaching and research institutions in France or abroad, or from public or private research centers.

L'archive ouverte pluridisciplinaire **HAL**, est destinée au dépôt et à la diffusion de documents scientifiques de niveau recherche, publiés ou non, émanant des établissements d'enseignement et de recherche français ou étrangers, des laboratoires publics ou privés.

Preliminary results

Searching for meteor ELF /VLF signatures

Jean-Louis Rault ¹

For more than two centuries, credible reports about various audible sounds appearing simultaneously with visible meteors have been collected. Knowing that the sound velocity is much lower than the light velocity, it was impossible to explain such a phenomenon until some theories predicted that an electromagnetic wave vector could be the reason for such simultaneous light and sound observations. Several optical/sound/radio recording campaigns have been performed in the last decades but with no conclusive reports. The present study simply aims to examine the low frequencies electromagnetic activity during a meteor shower and to search for any interesting correlations with meteors detected by VHF forward scatter means. Preliminary results tend to show a significant correlation between certain meteors and the time-correlated corresponding ELF/VLF events.

Presented at the International Meteor Conference 2009, Poreč, Croatia, 2009 September 24–27

Received 2009 September 23

1 Introduction

Audible sounds heard at the same time as fireballs are in view have been reported for many years by hundreds of credible witnesses. As the speed of sound in our atmosphere is around 340 meters per second and fireballs generally appear at altitudes of tens of kilometers, the sounds associated to the fireballs should be delayed by several hundreds of seconds. To explain these anomalous sounds appearing simultaneously with meteors, Keay (1980) proposed that some ELF/VLF (extremely low frequency/very low frequency) electromagnetic energy is radiated by the decaying meteor and then transduced into audible sounds at the observer location. This ELF/VLF high speed vector is supposed to explain the observed simultaneity of sound and meteor light. A Global Electrophonic Fireball Survey performed by Vinković et al. (2002) suggests that the electrophonic meteors, as Keay named them, produce a very wide family of hissing, swishing, rustling, buzzing, whooshing or crackling sounds. Keay's theory states that trapping and twisting the earth magnetic field lines in the turbulent wake of the largest meteors and then releasing them suddenly could be the reason for producing high power ELF/VLF radiation in the 100 Hz to 10 kHz range. Beech and Foschini (1999) explained that Keay's theory was only able to explain the long duration noises such as hisses and other high-pitched whistles, but not the pops, ticks and other claps which were often reported. They developed their own "space charge model" theory which states that some sharp shock waves occurring in the meteor trail plasma could induce some sudden electrical field transients. Depending on the authors, the magnitudes of the electrophonic fireballs vary from magnitude -10 (Beech et al., 1995) to -6.6 (Beech & Foschini, 1999). Price and Blum (2000) state that many weaker meteors can also radiate detectable ELF/VLF electromagnetic energy (Drobnock, 2001 and 2002). In fact, due to the extreme rareness of the phe-

nomenon, instrumentally recorded electrophonic meteor data are very scarce. Keay (1994) for example presents an observation by Watanabe et al. (1988) about one single coincidence between a particular ELF radio spike and a photographed fireball. Beech et al. (1995), thanks to a VLF receiver associated to a photometer, observed during their Perseids 1993 campaign a single VLF event coupled with a magnitude -10 fireball. During the 1999 Leonid return, Price and Blum (2000) detected an important increase of the number of VLF spikes in the 300 Hz frequency range, but did not correlate the observed radio spikes to any particular discrete meteors. Garaj et al. (1999) detected during a 5.5 hours record session in Mongolia some coincident meteor light flashes and VLF radio emissions, but no correlated audible sounds. During the 2001 Leonids, Trautner et al. (2002) detected an enhanced activity in the ULF/ELF electric field, but again no particular meteors were associated with any of the recorded ELF-ULF events. More recently, Guha et al. (2009) argued they detected some long VLF meteor signatures in the 6 kHz range during the Geminids 2007 meteor shower, but they did not correlate them with any discrete observed meteors. Due to the lack of convincing detections of electrophonic meteor VLF radiations, the Keay magnetic field theory and the Beech et al. electrical field transients theory still have to be confirmed by more experimental data associating light, sound and/or ELF/VLF radio wave sensors. The purpose of the present experiment, "Searching for meteor ELF/VLF signatures" is simply to verify, by means of statistical analysis of coincidences between radio and meteor events and by spectral analysis of the candidate VLF radio events, that some meteors entering the Earth atmosphere are radiating some detectable ELF/VLF electromagnetic energy.

2 Experiment

2.1 Experiment principle

The aim of this study is to record in parallel as many ELF/VLF events and meteor detections as possible, to compare any incident radio signals (in the 20 Hz–20

¹16, rue de la Vallée 91360 Epinay sur Orge, France
Email: f6agr@orange.fr

kHz range) with any occurrence of meteors in the radio field of view of the observer, and to determine statistically if the radio events are significantly correlated with the incoming meteors. A signature analysis of each radio event related to a particular meteor is also performed in the frequency and in the time domain, as an attempt to perform a kind of taxonomy study of the meteor radio signatures, if any. To detect as many meteors as possible, the radio forward scatter method was selected (Rault, 2007), rather than the optical observation method. Compared to the visual/video meteor observation method, the forward scatter radio method is offering more opportunities to detect faint and bright meteors (up to several hundreds of radio echoes from sporadic meteors per hour), and is not subject to disturbances from the Sun and Moon light or from any masking clouds or fog. A radio meteor detection system is able to work 24 hours a day, except for the few periods when an anomalous radio propagation phenomenon occurs, such as Es (apparition of a sporadic E layer ionized cloud) or in case of tropospheric propagation. The idea behind this is that by multiplying the number of meteor detections, the chances should be higher to identify interesting temporal correlations between the meteor arrivals and the ELF/VLF events. It has to be noted that the data reduction of such records is quite challenging, because the ELF/VLF spectrum is crowded with natural and man-made signals. Each coincidence between a radio and a meteor event has therefore to be processed manually. Many technical details are given in this publication, the goal being to encourage others to investigate in this domain.

3 Observational set-up

As is shown in Figure 1, the observational set-up is mainly made of:

- a VHF reception chain dedicated to the forward scatter detection of meteor pings,
- an ELF/VLF sensor,
- a stereo digital recorder.

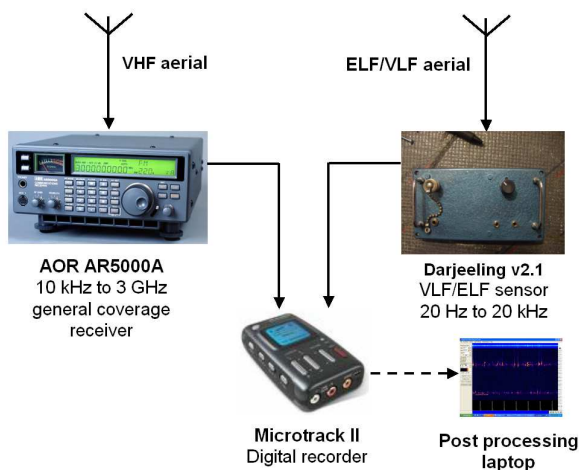

Figure 1 – Instrument configuration.

The equipment is designed to be portable, self powered and as light as possible. The reason is that it has to be run in remote areas only, i.e. as far as possible from any power lines, cities, or railways which always radiate a lot of hum and various anthropic noises. The data crunching set-up consists of a laptop computer fitted with a spectral analysis software whose purpose is to process and to display simultaneously the data coming from the stereo channels.

Most of the laptop computers are poor field audio recorders because most of them radiate a lot of various radio noises in the VLF to VHF domain. Furthermore, their embedded audio sound chipset does not generally fit the dynamic and frequency range required for the ELF/VLF records. This is the reason why a good quality digital recorder has to be preferred.

The data recorded in the field are stored on Compact Flash memories whose contents can be easily transferred to any computer for further analysis. As is shown in Figure 2, the portable equipment is protected by a watertight container and powered by a 12 V car battery. This portable recording system design is presently subject to variations and permanent improvements. The current configuration (2009 June) consists of:

- a VHF antenna (50 MHz dipole or 4 elements Yagi 143 MHz beam, depending on the forward scatter transmitter to be used),
- an AOR AR5000A general coverage receiver (10 kHz to 3 GHz, all modes) dedicated to meteor ping reception, but also occasionally used to receive some time stamps from several VLF or short wave time signal transmitters,
- an ELF/VLF cylindrical antenna,
- a home-brew ELF/VLF receiver,
- an M-Audio Microtrack II digital recorder fitted with a exchangeable 8 Gb Compact Flash memory card,
- a 12 V/ 54 Ah car battery giving a recording autonomy of more than 48 hours,



Figure 2 – Actual field installation.

- a 12 V/5 V DC/DC converter used to enhance the autonomy of the internal battery of the digital recorder,
- several ancillaries such as a 12 V LED light, a set of headphones, a batch of various cables, a laptop computer to control the records in the field and a “survival toolkit” including various tools, spare parts and a 12 V DC soldering iron.

The general coverage AOR receiver and the Micro-track II digital recorder are commercial equipment, so all the technical details can be found in the manufacturer specifications available on the Internet. More details about the ELF/VLF antenna and its associated receiver are given below, because they were specially developed for the present experiment. The specification requirements for the ELF/VLF reception chain were as follows:

- cut-off frequency as low as possible,
- high dynamic range,
- low distortion,
- light weight,
- low cost,
- low power consumption.

The frequency response of the Microtrack II recorder (20 Hz to 20 kHz ± 0.3 dB) and its dynamic range (101 dB) at 48 kHz sample rate were used as metrics for the development of the associated ELF/VLF antenna and receiver. The ELF/VLF part of the radio spectrum corresponds to very long wavelengths, ranging from 15 kilometers to more than 15 000 kilometers. It means that the antenna dimensions look necessarily very small compared to the wavelengths to be observed. Two types of aerials can be used in such conditions, the magnetic loops and the electrically short whips, which are respectively sensitive to the magnetic and to the electrical component of the incident RF electromagnetic field. An ELF/VLF magnetic loop is heavy, bulky and difficult enough to build (many turns of copper have to be wound on a very large and strong frame), so the electrically short whip principle was selected for this experiment. It has to be noted that such an “electrical field” receiver is sensitive to the electrical component of any incident electromagnetic wave, but also to any electrostatic field variations. Such a short whip presents a very high capacitive reactance in series with a very low radiation resistance.

The capacitance of such an aerial is:

$$C = \frac{24.2l}{\log\left(\frac{2l}{0.001d}\right) - 0.77353} \quad (1)$$

with C expressed in picofarads, l (the length of the aerial) in meters and d (the diameter of the aerial) in millimeters. The radiation resistance can be neglected, as it is presenting a very low value which is in the $10^{-7}\Omega$

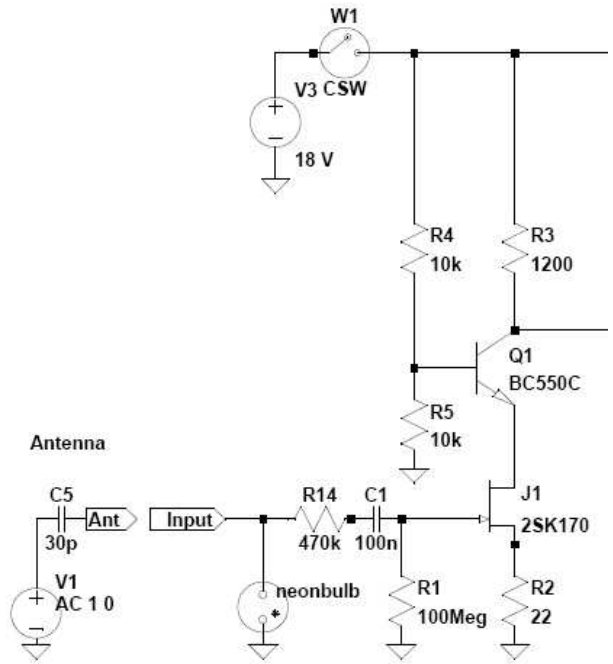

Figure 3 – Front end diagram of the ELF/VLF receiver.

range. The antenna built for this experiment is a one meter long metallic cylinder with a diameter of 50 mm, which gives a capacitance of about 29 pF. It consists of a rectangular piece of wire mesh wrapped around a plastic foam cylinder. Such vibrations dampening device was preferred to the usual thin and rigid whip aerial for two main reasons:

- it is less sensitive to the mechanical vibrations provoked by the strong winds which can be faced in the field,
- the capacitance of such a large diameter antenna is higher than the one of a thin whip, improving therefore the low cut-off frequency of the reception chain.

Such a low series capacitance antenna implies the use of a very high input impedance amplifier. A FET/BJT (Field Effect Transistor/Bipolar Junction Transistor) cascade front end design was selected, because of

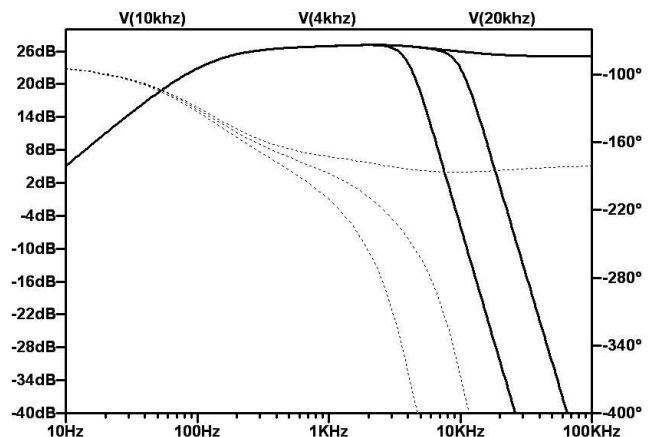

Figure 4 – Simulated bandwidth of the entire ELF/VLF reception chain (aerial, front end and switchable Butterworth filters).

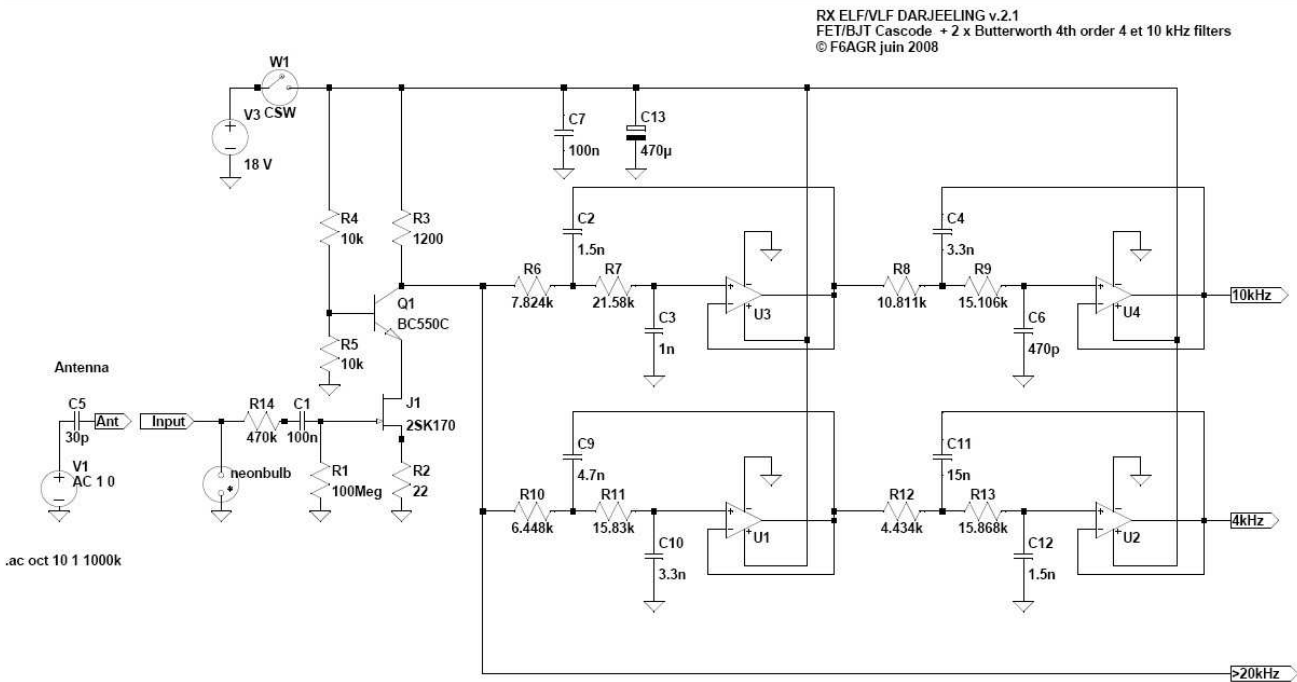

Figure 5 – Diagram of the entire ELF/VLF receiver.

its intrinsic qualities, such as high input impedance, low noise, low distortion, and high dynamic range. The detailed diagram of the front end stage of the receiver is shown in Figure 3.

The 2SK170 FET and BC550C BJT transistors were selected owing to their good performances in the noise, dynamic range, and distortion domains. The gate of the FET transistor is grounded thanks to a 100 M Ω resistance made of ten 10 M Ω low noise metallic film resistors wired in series. This very high value resistance is mandatory to keep the low cut-off frequency performance of the whole reception chain as low as possible.

The neon bulb is an attempt to protect the front-end against any high electrostatic discharges, but its effectiveness is not 100% certified. The 470 k Ω R14 resistor, which is not mandatory, is used to protect the receiver against any high level RF fields which could be received from nearby or powerful broadcast transmitters, if any. R14 can be removed if the receiver is to be used in radioelectrically quiet places.

The front end stage is followed by two selectable low pass filters. Each of them consists of a classical 4th order Butterworth filter presenting a theoretical roll-off rate of 80 dB per decade (see Figure 4). The first filter is a 4 kHz low pass filter, the second one is a 10 kHz filter. The frequency band-pass of the receiver is shown by continuous lines in Figure 4 (output amplitude in decibels versus frequency), depending on which filter — or no filter — is selected. The three dotted lines represent the corresponding phase shifts (in degrees). To obtain good filtering performances, it is important to respect as much as possible the values of the R and C components constituting the Butterworth filters. This can be achieved by using series or parallel combinations of resistors chosen in the 1% tolerance family. Figure 5 shows the diagram of the complete ELF/VLF receiver

which is powered by two 9 V rechargeable batteries wired in series. Its consumption with a 18 V power supply is about 10 mA. Shielded cables must be used to connect the ELF/VLF and VHF receivers outputs to the digital recorder stereo inputs. The ELF/VLF antenna has to be kept away from the electronic devices. A low capacitance coaxial cable, whose length has to be as short as possible, must be used to connect it to the receiver input. The type of cable used for car radio antennas is preferred for the present experiment. Its linear capacitance is about 37 pF/m, instead of 100 pF/m which is a typical value observed on most of the usual 50 Ω coaxial cables. The system must be grounded with the help of a ground rod driven in a moistened soil. It is recommended to install the digital recorder in a little tight metal box, because its front panel display is likely to radiate some unexpected noises.

3.1 Observation location

Choosing the right observation place is a delicate task. Finding a good location for the reception of the VHF forward scatter meteor pings is not difficult. The constraint is only to install the VHF aerial in a clear area which is free of any nearby obstacle masking the sky and the horizon.

On the other hand, the quality of the ELF/VLF data is subject to two main conditions:

- avoiding the presence of any objects (tree, bush, car, building, pole, etc.) or people in the vicinity of the antenna, because they all deeply attenuate the incoming signals,
- locating the system as far as possible (i.e. some kilometers if possible) from any power lines or buildings which always radiate a huge amount of hum, main harmonics, and various spikes.

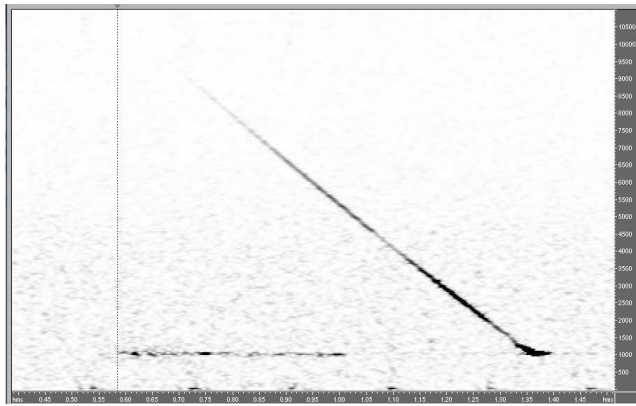

Figure 6 – Example of a meteor head echo displayed in the frequency domain.

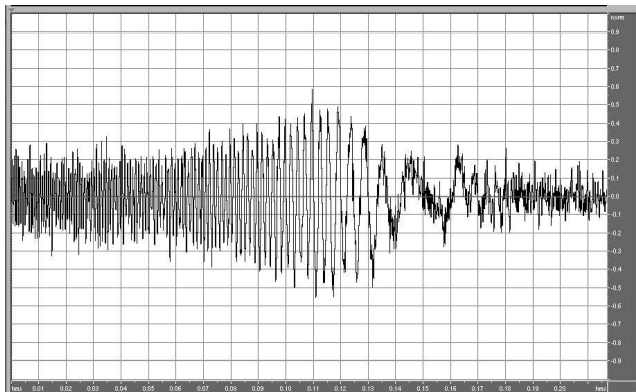

Figure 7 – Example of the same meteor head echo in the time domain.

The second condition is more and more difficult nowadays to meet in Europe. Each candidate location has to be carefully checked before installing and running the entire system. Using a light portable station consisting only of a 50 cm vertical whip, the ELF/VLF receiver and the digital recorder fitted with a pair of headphones allow to check quickly if there are no bad surprises in the selected field, such as a buried 220 V AC line, or some noisy sheep electric fences (as it happens often, even in “desert” regions of France such as the Aubrac or Larzac tablelands).

3.2 Tentative taxonomy of the event signatures

3.2.1 Event representation

The analysis of the signatures of the VHF meteor pings, of the ELF/VLF signals, and of their potential coincidence is performed by looking at the event signatures in the frequency and in the time domain, and by listening to them thanks to a stereo headset. For this purpose, a free Digital Audio Editor such as Audacity¹, or a more powerful but more complex Signal Analysis Toolkit such as Spectrum Lab² are perfectly suitable.

¹<http://audacity.sourceforge.net>

²<http://freenet-homepage.de/dl4yhf/spectra1.html>

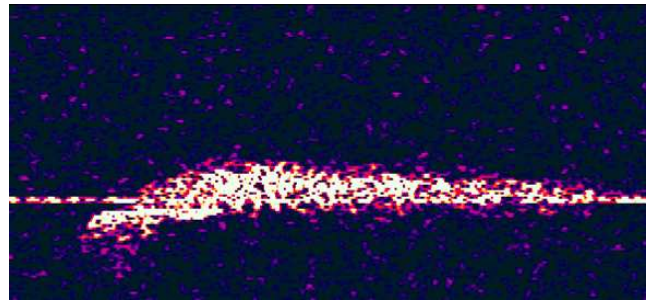

Figure 8 – Example of a Tt (meteor turbulent trail) echo.

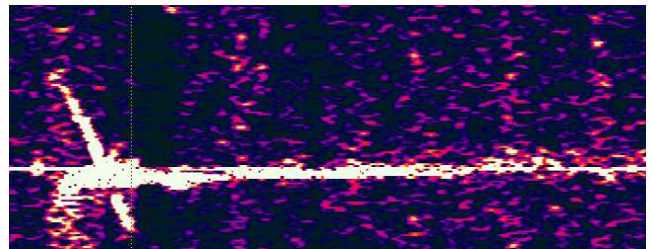

Figure 9 – Example of a HTt (head and turbulent trail) meteor echo represented in the frequency domain.

3.2.2 Meteor echo signatures

The VHF pings are radio echoes coming from a distant transmitter illuminating the meteors (or more precisely, illuminating the ionized trails and/or the plasma surrounding the meteoroids themselves). The actual echo radio frequency (around 50 or 143 MHz) is translated by the VHF receiver into audio frequencies (20 Hz to 20 kHz) which can be easily perceived by the human ear and processed thanks to a common PC sound card. A frequency analysis of the incoming meteor echoes is the most suitable tool to study the meteor pings, because it gives details on the speed of the meteor and/or its trail. For this study, the different types of meteor echoes have been classified as follows:

- the H type (H for head echo, see Figures 6 and 7)
- the T type (T for trail echo) including the two subclasses Tt and Ts, standing for turbulent trail echo (see Figure 8) and smooth trail echo.

In the two head echo examples above, the signal frequency of the echo decreases versus time, and this is due to the Doppler effect produced by the fast moving target (the plasma surrounding the meteoroid itself).

Figure 8 represents a trail echo which is frequency spread because of a heavy turbulence affecting the ionized trail. The overall shape of the echo looks like an inverted U, and this is due to the fact that the trail is moving at a speed of a few tens of meters per second, thanks to the high altitude winds.

A meteor head echo followed by its ionized trail echo is shown in Figure 9.

3.2.3 ELF/VLF event signatures

The 5 Hz to 24 kHz electromagnetic spectrum which we are looking at for this study is crowded with a lot of various anthropic and natural noises. Some examples of natural noises recorded during this study are shown

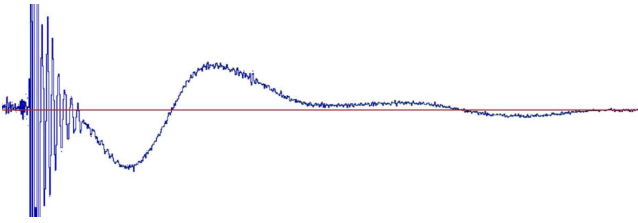

Figure 10 – Example of diurnal slow-tailed sferic (time domain).

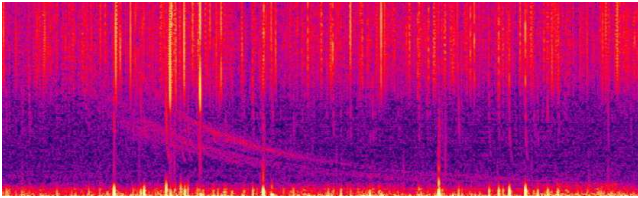

Figure 11 – Example of whistler (frequency domain).



Figure 12 – Burst of return strokes during a thunderbolt (time domain).

in Figures 10 to 12. These most common natural noises at the 40 to 50° North latitude locations are caused by several geophysical phenomena such as:

- sferics (distant lightning spikes propagating in the ionosphere-Earth waveguide during the daylight)
- tweeks (night sferics)
- whistlers (sferics propagated from the opposite hemisphere along the Earth magnetic field lines)

The shape of the slow tail sferic (see Figure 11) is due to a propagation phenomenon of the VLF broadband spike within the Earth surface/ionosphere waveguide. The upper frequencies in such a waveguide travel according to a TM (transverse magnetic mode), and the lower frequencies (at the right of the figure) travel at a lower group speed according to a QTEM (quasi transverse electric magnetic) propagation mode. The TM mode presents a low frequency cutoff and the waves propagate with a higher velocity than with the TEM mode (Cummer, 1997; Delcourt, 2003). The various group velocities of the components of distant lightning spikes traveling in the magnetospheric plasma along the Earth magnetic field lines explain again the shape of

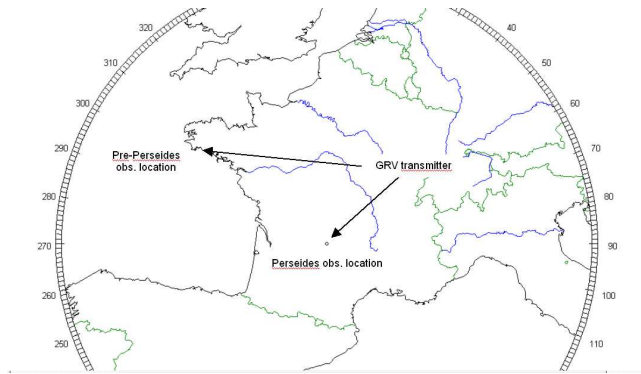

Figure 13 – Perseids 2009 observation locations.

a whistler. In Figure 12, the highest frequencies are reaching the observer before the lowest ones. The details above about all these kind of ELF/VLF events are given just to show that many natural event signatures are well known and quite easy to identify.

4 Results

A 143 MHz transmitter was preferred for this campaign instead of a 50 MHz one. The main reason for this choice is that the power of the meteor echoes decreases with the third power of the frequency, and their duration as the square, allowing thus to only detect the larger meteors. Furthermore, using a higher frequency scalpel provides more detailed echoes, and much better head echoes than on lower frequencies.

More than 20 hours of VLF and VHF radio observations, i.e. about 20 GB of data have been recorded during the pre-Perseids 2009 (August 6 in Brittany) and the Perseids 2009 (August 11 and 12 in Corrèze). Ten hours and ten minutes of data records have been carefully analyzed, mainly during the first and second burst (i.e. around 8 AM and 6 PM UTC) of the Perseids but not during the third burst at 6 AM UTC on August 13, which was not recorded). During these 610 minutes, 500 meteors have been detected thanks to the French Graves military radar operating on 143 MHz (see Figure 13).

For these 500 meteors, 174 coincidences were observed with ELF/VLF events, which gives 35% of candidate meteors radiating some very low frequency electromagnetic energy when entering the Earth's atmosphere. Great care has been taken for deciding if an ELF/VLF event was related to a meteor or not:

- the time between a VHF meteor detection and a possibly related ELF/VLF event had to be less than 500 ms,
- The signature of the associated ELF/VLF event had to be of unusual amplitude or shape compared to the well known common natural noise signatures. The details about the different sorts of meteor and ELF/VLF events are shown in Tables 1 and 2.

In Table 1, the meteor echo signatures are identified as follows: \ : head echo; __ : head echo followed by

Table 1 – Meteor echoes sorted by type.

File	\	_	=_	----	=====	Misc.	Total
40	6	15	0	13	2	2	38
42	4	14	0	9	7	3	37
68b	8	12	0	10	3	5	38
69b	131	37	0	21	5	28	222
78	34	4	2	26	1	33	100
79	4	1	1	2	2	5	15
80	5	3	7	1	2	5	23
81	10	2	2	2	5	6	27
Total	202	88	12	84	27	87	500

Table 2 – ELF/VLF events sorted by type.

File	ELF	VLF	Spikes	Tweek	Misc.	Total
40	7	1	12	1	1	22
42	7	3	11	0	3	24
68b	2	0	11	2	7	22
69b	9	5	24	0	11	49
78	5	2	4	0	13	24
79	1	0	6	0	2	9
80	1	0	6	0	4	11
81	2	0	8	0	3	13
Total	34	11	82	3	44	174

a trail echo; =_ : head echo with a turbulent trail at the beginning, followed by a smooth trail echo; ---- : smooth trail echo; ===== : turbulent trail echo.

In Table 2, the ELF/VLF event signatures are classified as follows:

ELF: extremely low frequency signal,

VLF: very low frequency signal,

Spikes: train of VLF spikes,

Tweek: night time sferics.

Some examples of remarkable coincidences are shown in Figures 14 to 19.

All these examples were selected because they looked representative of interesting ELF/VLF meteor candidates, their low frequency radio signatures being different from the common natural noises. It is to be noted that almost all of the detected ELF/VLF meteor events occurred during the decaying phase of the meteoroids, and not during the trail echo phase. This is tending to prove that the radio frequency radiations, if any, occur mainly during the ablation phase of the meteors and are not generated by any persistent trail plasma phenomenon. No long duration ELF/VLF event signals at all were detected during this study. All of them belong to the short duration/spike category, unlike some recent observations (Guha et al., 2009) claiming long duration signals in the 6 kHz band. Figure 14 shows a typical low frequency burst accompanying the head echo of a meteor. Figure 17 is an example of an unusually large long-tailed spike (thirty four similar ELF spikes were identified during this study). Figure 19 shows a burst consisting of some uncommon saw tooth spikes with a period of around 4 ms. Figure 20 is an example of a VHF reflection on a cloud-cloud thunderbolt ionized column, which has nothing to do with a real meteor echo (Rault, 2005). Some thunder activity was localized in northern Spain (see Figure 21) at the time

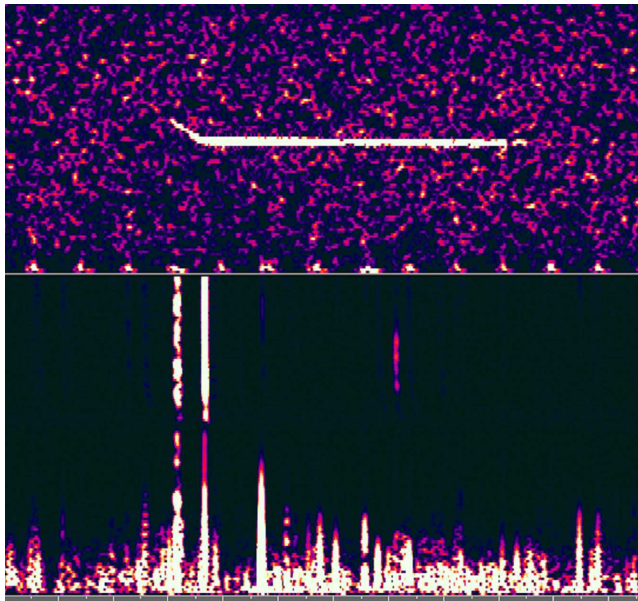

Figure 14 – VLF spikes during a meteor head echo (frequency domain).

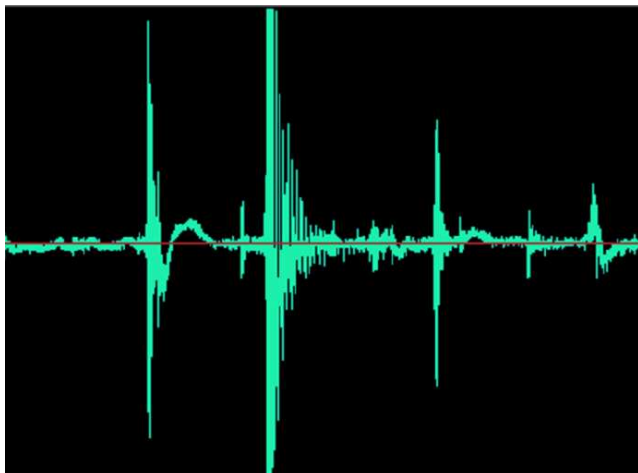

Figure 15 – Same VLF spikes but seen in the time domain.

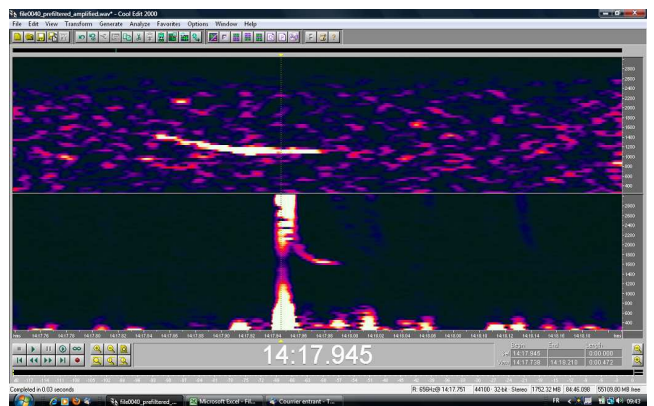

Figure 16 – ELF tweek associated to a VHF meteor ping.

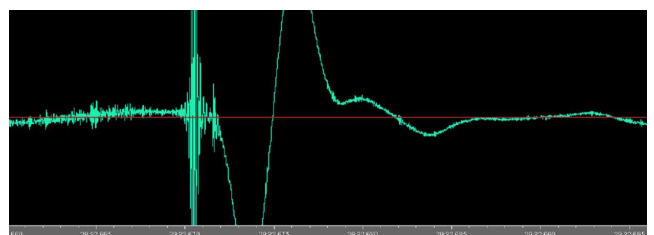

Figure 17 – Time domain representation of a very large ELF spike associated with a meteor ping.

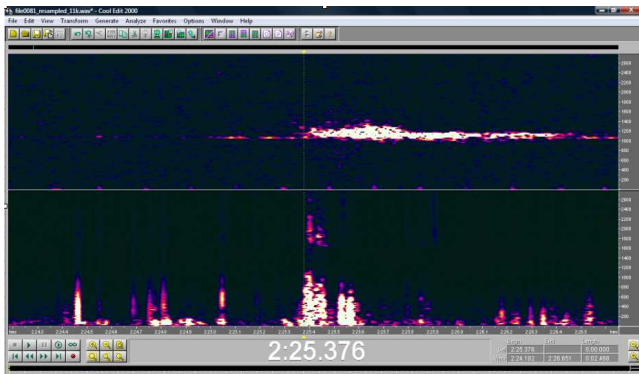

Figure 18 – Burst VLF spikes associated with the beginning of a turbulent meteor trail.

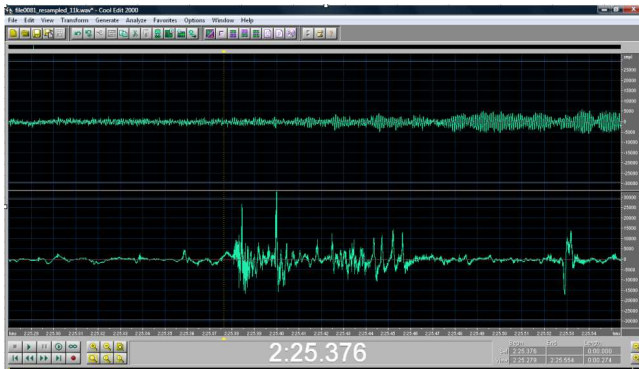

Figure 19 – Time domain representation of the above VLF burst.

several similar events were recorded. Such a thunderbolt event shows that the greatest care has to be taken when performing such an event analysis. A good knowledge about the VHF echo signatures and the ELF/VLF event shapes is mandatory for correctly identifying the potential candidate samples.

5 Discussion

Looking for correlations between meteors and ELF/VLF events is a very demanding and a very time consuming task. The detection of the interesting events cannot be automated, because the ELF/VLF event signatures are not known in advance. At the beginning of this work, a statistical approach was envisaged. Determining the statistical rate of fortuitous coincidences between the meteors and any of the low frequency events and then comparing it to the observed rate was thought to be a good indication of any meteor radiated radio energy. One file containing 100 meteor pings, 24 coincidences at less than 500 ms and 2880 ELF/VLF radio events was therefore used to compute the statistical chances for fortuitous coincidences to appear. With the collected data, the chance for one VLF event to fortuitously appear at less than 500 ms from a meteor ping was around 42% for a one hour record. Compared to the 24% of observed correlations, this is clearly not a convincing indication of any meteor radio radiation. This is due to the fact that all the ELF/VLF events were taken into account, and the huge number of events was polluting the final result. So another approach was finally used for this work, which consists in selecting only the

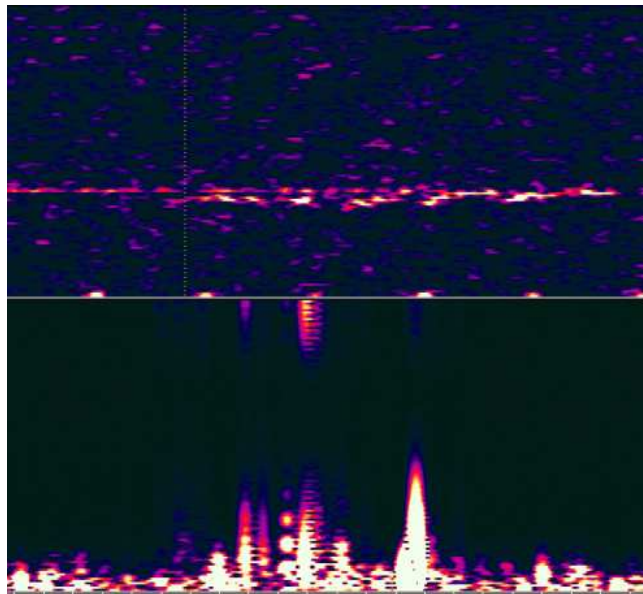

Figure 20 – Upper trace: VHF reflection on a lightning. Lower trace: associated VLF return strokes.

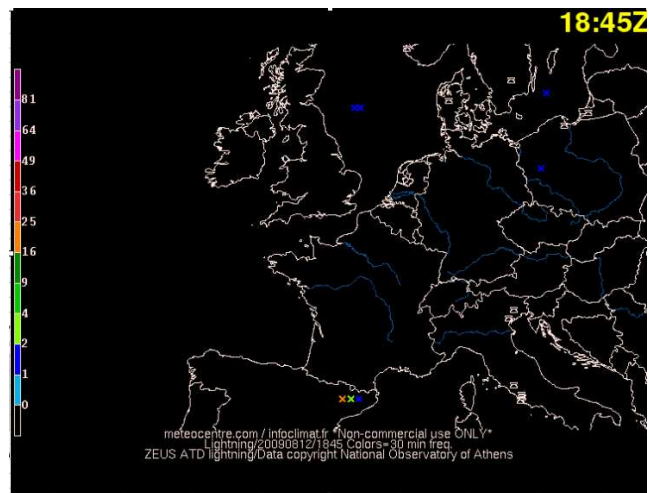

Figure 21 – Thunder activity (see $\times\times\times$ crosses in the northern Spain area) at 18:45 UTC of 2009 August 12.

ELF/VLF events whose signatures are clearly different from the usual ones. These candidate meteor ELF/VLF signatures are listed in Table 2. 174 ELF/VLF events for 500 VHF meteor echoes (i.e. about 35%) is a very encouraging result.

6 Conclusions

The theories stating that some meteors can radiate low frequency electromagnetic energy seem to be supported by the present practical study which is based on hundreds of actual discrete observations of meteors and ELF/VLF events. It is to be noted that the 35% of the observed candidate correlations seem to happen most of the time during the beginning of the meteor radio reflections. However, more data are still needed to confirm such a conclusion. The next meteor showers (such as the promising Leonids 2009) should be the next opportunities to collect more interesting correlations.

Acknowledgments

Thanks a lot to Karl Antier and to Pierre Gaillard (Département Analyse et Surveillance de l'Environnement, CEA) for their useful advices about the statistical approach attempted during this work.

References

- Beech M., Brown P., and Jones J. (1995). "VLF detection of fireballs". *Earth Moon and Planets*, **68**, 181–188.
- Beech M. and Foschini L. (1999). "A space charge model for electrophonic bursters". *Astron. Astrophys.*, **345**, L27–L31.
- Cummer S. A. (1997). *Lightning and remote ionospheric sensing using VLF/ELF radio atmospherics*. PhD thesis, Stanford University.
- Delcourt J. J. (2003). *Ionosphère: région D, sondage passif et propagation des signaux LF et VLF*. Hermes Science Publications. ISBN 978-2746206564.
- Drobnock G. J. (2001). "Meteors producing VLF signatures independent from producing electrophonic sounds". *WGN, Journal of the IMO*, **29:1**, 45–50.
- Drobnock G. J. (2002). "VLF signatures from non-fireball meteors – Observations from the 2001 Leonid shower". *WGN, Journal of the IMO*, **30:5**, 152–156.
- Garaj S., Vinković D., Zgrablić G., Kovačić D., Gradečak S., Biliškov N., Grbac N., and Andreić Ž. (1999). "Observational detection of meteor-produced VLF electromagnetic radiation". *Fizika A (Zagreb)*, **8:3**, 91–98.
- Guha A., De B. K., and Roy R. (2009). "Possible detection of Geminid 2007 meteor shower during daytime from VLF radiation spectra". *Earth Moon and Planets*, **105:1**, 31–40.
- Keay C. S. L. (1980). "Anomalous sounds from the entry of meteor fireballs". *Science*, **210**, 11–15.
- Keay C. S. L. (1992). "Meteor fireball sounds identified". In *Asteroids, Comets, Meteors 1991*, pages 297–300. Lunar and Planetary Institute, Huston.
- Keay C. S. L. (1994). "Audible fireballs and geophysical electrophonics". In *Proceedings ASA 1994*, volume 11, pages 12–15.
- Price C. and Blum M. (2000). "ELF/VLF radiation produced by the 1999 Leonids meteors". *Earth Moon and Planets*, **82-83**, 545–554.
- Rault J.-L. (2003). "A la découverte des fréquences basses". *Radio-REF*. January and March.
- Rault J.-L. (2005). "Lightning scatter: a faint and rare mode of propagation". *VHF Communications*, **2**.
- Rault J.-L. (2007). "Radio observation of meteors – Leonids as an example". *Observations & Travaux*, **65**, 1–8.
- Trautner R., Koschny D., Witasse O., Zender J., and Knöfel A. (2002). "ULF-VLF electric field measurements during the 2001 Leonid storm". In Warmbein B., editor, *Proceedings of Asteroids, Comets, Meteors – ACM 2002*, pages 161–164. Noordwijk, Netherlands: ESA Publications Division.
- Vinković D., Garaj S., Lim P. L., Kovačić D., Zgrablić G., and Andreić Ž. (2002). "Global electrophonic fireball survey: a review of witness reports – I". *WGN, Journal of the IMO*, **30:6**, 244–257.
- Watanabe T., Okada T., and Suzuki K. (1988). "Meteor and radio wave". *HAM Journal (Japan)*, **54**, 109–115. (in Japanese).

Handling Editor: Željko Andreić