



**HAL**  
open science

# Virtual gauge representation for geometric tolerances in CAD-CAM systems.

Eric Pairel, Pascal Hernandez, Max Giordano

► **To cite this version:**

Eric Pairel, Pascal Hernandez, Max Giordano. Virtual gauge representation for geometric tolerances in CAD-CAM systems.. J.K. Davidson. Models for Computer Aided Tolerancing in Design and Manufacturing, Springer, pp.3-12, 2007. hal-00638011

**HAL Id: hal-00638011**

**<https://hal.science/hal-00638011>**

Submitted on 4 Nov 2012

**HAL** is a multi-disciplinary open access archive for the deposit and dissemination of scientific research documents, whether they are published or not. The documents may come from teaching and research institutions in France or abroad, or from public or private research centers.

L'archive ouverte pluridisciplinaire **HAL**, est destinée au dépôt et à la diffusion de documents scientifiques de niveau recherche, publiés ou non, émanant des établissements d'enseignement et de recherche français ou étrangers, des laboratoires publics ou privés.

# Virtual Gauge Representation for Geometric Tolerances in CAD-CAM Systems

*Eric PAIREL, Pascal HERNANDEZ, Max GIORDANO*  
*LMECA (Laboratoire de Mécanique Appliquée)*  
*École Supérieure d'Ingénieurs d'Annecy - Université de Savoie*  
*BP 806, 74016 ANNECY Cedex - FRANCE*  
*eric.pairel@univ-savoie.fr*

**Abstract:** The CAD software seeks to represent the syntax of the geometric tolerances, i.e. their writing on the drawings. We propose to represent their semantics, i.e. their meaning with respect to the part. We show that the meaning of the geometric tolerances can be defined thanks to a model of virtual gauges. These gauges concern geometrical entities of the part which are represented on the three-dimensional geometrical model of the part (CAD model). The topology of a gauge is related to that of the part. Recording these attributes is sufficient. The advantages of this representation are its simplicity, the semantic coherence which can be guaranteed, the independence from the standards, their limits and their evolutions, and the extension of the tolerancing possibilities for the designer.

**Key words:** Tolerancing, Virtual gauge, CAD-CAM.

## 1. INTRODUCTION

The subject of this paper is to present the bases of a data-processing representation of the geometric tolerances. The tolerances which are considered are those which are allowed by the ISO and ASME standards. Nevertheless, we will show that the suggested representation allows to specify functional tolerances which are difficult and even impossible to express with the writing rules of the standards. Indeed it is necessary to distinguish the *syntax* of a geometric tolerance, i.e. its writing on the technical drawing, and its *semantics*, i.e. its meaning with regard to the part. Whereas the CAD software packages try to represent the syntax of the geometric tolerances, we propose to represent their semantics. The task is then much simpler because, while the syntactic rules of the standardized tolerances are many and are badly formalized, we think that their semantics can always be interpreted in the form of a virtual gauge.

Several authors have already shown this geometrical interpretation of tolerances [Jayaraman *et al.*, 1989], [Etesami, 1991], [Nigam *et al.*, 1993]. Some of them have tried to model it [Ballu *et al.*, 1997], [Dantan *et al.*, 1999]. This geometrical interpretation is also found in the American standard [ASME, 1994].

However we think that none of these contributions has brought as complete and simple a model as the *fitting gauge model* which we have developed since 1995 for the three-dimensional metrology [Pairel *et al.*, 1995]. Here we propose using this model to represent the geometric tolerances in the CAD-CAM systems. We will show that it enables to model a multitude of geometric tolerances very simply.

This semantic representation of the tolerances must be accompanied by a checking of the degrees of freedom removed by references [Kandikjan *et al.*, 2001] and left at the tolerance zones [Hernandez *et al.*, 2002] to guarantee the full semantic coherence of the tolerances. This checking will not be detailed here.

From this tolerance representation, it becomes simpler and more direct to generate the domains of the geometrical variations allowed to the faces of the part [Giordano *et al.*, 1999] [Roy *et al.*, 1999] [Davidson *et al.*, 2002], which is necessary to the analysis and synthesis tolerance processes of a mechanism [Giordano *et al.*, 2001].

## 2. INTERPRETATION BY VIRTUAL GAUGE OF THE STANDARDIZED GEOMETRIC TOLERANCES

In order to present the "fitting gauge model" and its use for the geometric tolerance representation, the technical drawing given on figure 1 will be used.

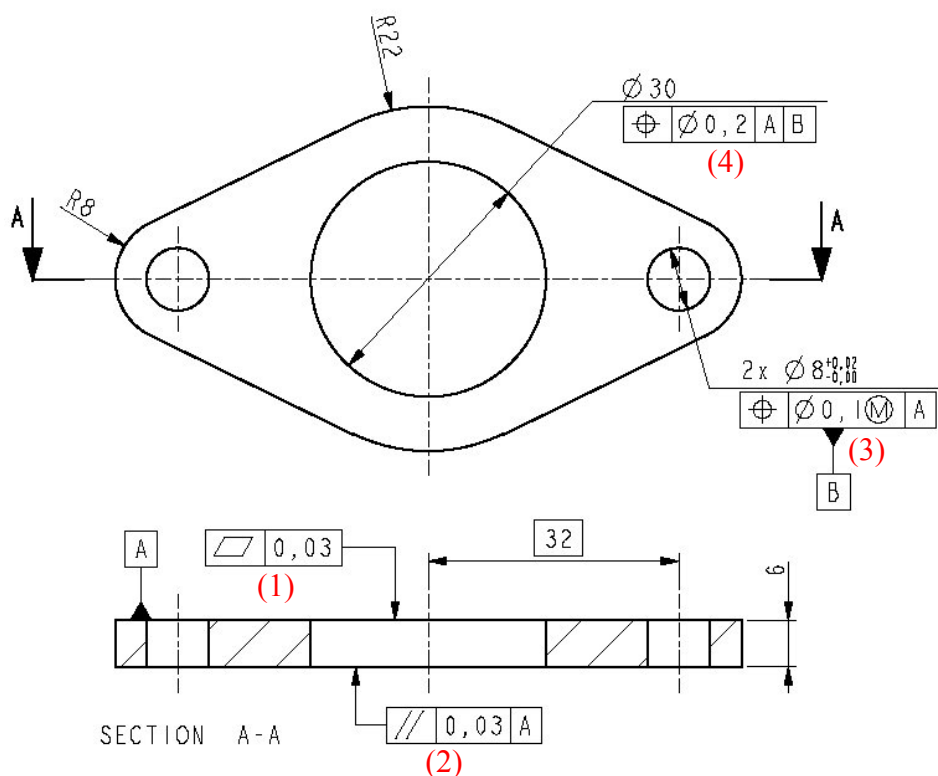

Figure 1; Examples of geometric tolerances.

This drawing reveals a broad panel of geometric tolerances: a tolerance of form (No 1 on figure 1), of orientation (No 2), and of position of a single feature (No 4) or of a group of features (No 3), as well as more or less complex *datum systems* (tolerances No 3 and 4). The maximum material condition (MMC) is also considered. The other categories of tolerance - run-out, minimum material condition, projected tolerance - will not be presented here but can also be represented. Only, the complementary indications, often added in the form of notes near the geometric tolerances, cannot be directly represented by the model presented here. The case of the dimensional tolerances is not mentioned here either.

### 2.1 Form Tolerance (tolerance No. 1) : the *zone-gauge*

The zone of a form tolerance constitutes a virtual gauge for the tolerated face or line. This gauge is completely free in displacement compared to the part :

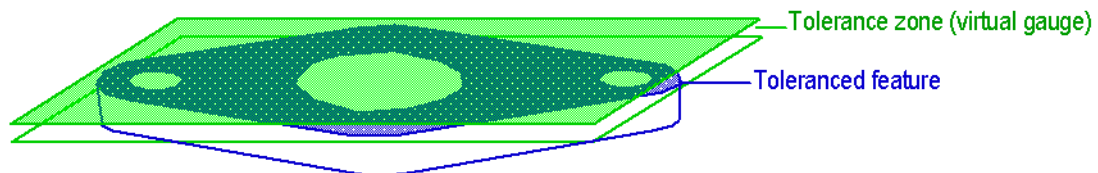

Figure 2; Interpretation of a form tolerance (flatness).

### 2.2 Orientation tolerance (tolerance No. 2): *Surface-gauge* - Degree of freedom of a gauge

Now the tolerance zone is "dependent" in orientation on a theoretical datum surface (here a plane). This datum surface is like a perfect plane which must be fitted with the "bottom" face of the part.

The orientation tolerance can be interpreted as a virtual gauge, composed of one plane (surface-gauge) and a tolerance zone (zone-gauge). The zone-gauge is linked to the plane-gauge but can move in translation in the three directions of the space. The Surface-gauge plane is fitted with the "bottom" face of the part. Then the zone-gauge can move in translation to try to contain the "top" face :

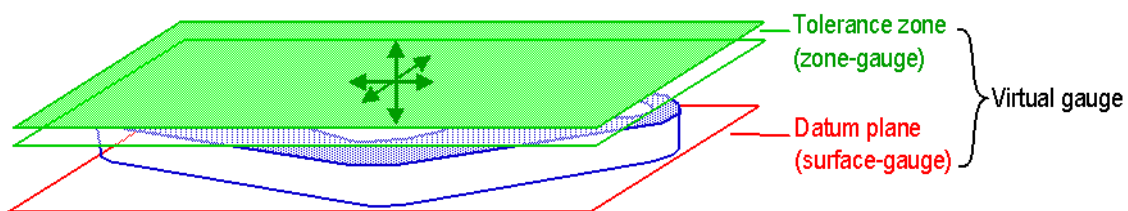

Figure 3; Interpretation of an orientation tolerance (parallelism).

### 2.3 Position tolerance for a pattern of features (tolerance No. 3) and maximum material requirement: surface-gauge whose size is fixed

The maximum material requirement defines a theoretical surfaces (border surfaces)

that the toleranced faces of the part do not have to cross. These theoretical surfaces are cylindrical surface-gauges of diameter equal to 7.9 mm. They are in theoretical positions between each another and with regard to the surface-gauge plane used as datum :

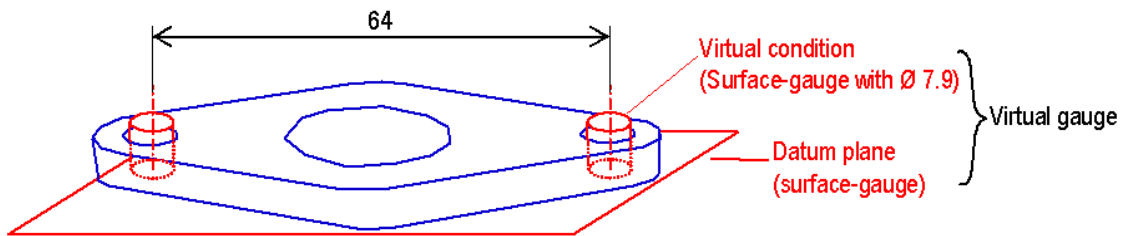

Figure 4; Interpretation of the maximum material requirement applied to a pattern of holes.

When the plane is fitted to the bottom face of the part, the virtual gauge, composed of the plane and the two cylinders, has three degrees of freedom corresponding to the established planar joint, which enables it to assemble the two cylinder-gauges inside the holes.

#### 2.4 Datum system and pattern of features taken as a datum (tolerance No. 4)

The virtual gauge is composed of four gauges: a plane surface-gauge, two cylindrical surface-gauges and one cylindrical zone-gauge. These gauges are linked together. The plane is fitted first on the bottom face of the part. Then the two cylindrical surface-gauges are fitted simultaneously inside the two small holes by increasing their diameters to a maximum. Then the virtual gauge does not have any degree of freedom with regard to the part. The zone-gauge must contain the axis of the large hole:

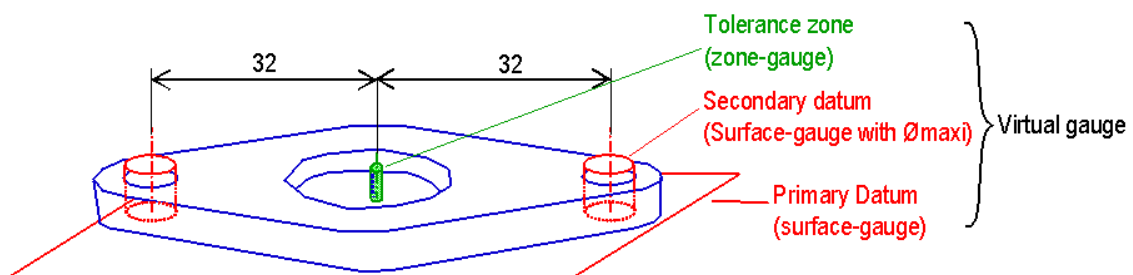

Figure 5; Interpretation of a position tolerance with a datum system.

### 3. PRESENTATION OF THE "FITTING GAUGE" MODEL

The gauges are theoretical constructions of elementary gauges (cylinder, plane, ...), each one being in relation to a geometric feature of the part. These elementary gauges are either the zone-gauges, or surface-gauges.

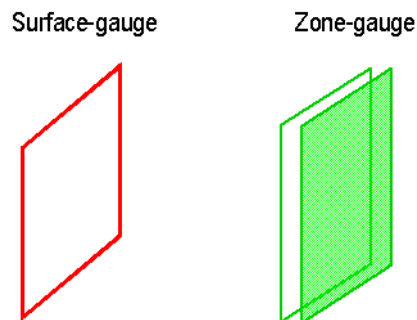

Figure 6; Surface-gauge and Zone-gauge.

The zone-gauges "materialize" the tolerance zones whereas surface-gauges "materialize", either the datums, or the virtual conditions.

The topology of a gauge is directly related to the one of the part: a surface-gauge has the nominal shape of the face with which it is in relation. A zone-gauge has the shape generated by the displacement of a sphere - of diameter equal to the tolerance - on the geometric feature with which the zone-gauge is in relation. Thus it is not useful to model the topology of the gauge in the data structure: topology is given by the CAD model. It is sufficient to record the type of gauge and its attributes.

#### 3.1 Attributes of a surface-gauge

A surface-gauge can have two types of behavior with regard to the geometric feature of the part: either it seeks to be fitted to the geometric feature of the part, or it only acts as border for it. It seeks to be fitted when it is used as datum and it only acts as border when it represents the virtual condition of the feature.

Levels of priority must be given to allow to define a chronological order for the fitting of the elementary gauges to the faces of the part. We will speak about *primary-fitting*, *secondary-fitting* and *tertiary-fitting*. We thus define a first attribute for the surface-gauge, which will be called "behavior", and which will be able to take four values:

- **Behavior = PrimFit, SecondFit, TertiaryFit, or Border**

If a surface-gauge has one or more intrinsic dimensions ("sizes"), those are free if the surface-gauge has a fitting behavior. They are fixed with a given value if it is a border. For example, the cylinder must have a variable diameter to be fitted and to be used as a datum on the part and a fixed diameter when it represents a virtual condition of a feature. So we define one or more attributes "size" for the surface-gauges:

- **Size**= Positive value if the size is fixed or a negative value if the size is not fixed and if the surface-gauge is fitting.

### 3.2 Attributes of a zone-gauge

The zone-gauge has only a role of border for the geometric feature of the part with which it is in relation. Its shape is determined by that of the geometric feature and by the value of the tolerance. It is thus sufficient to introduce an attribute giving the value of the tolerance:

- **TolValue** = Positive value

When the zone-gauge represents a zone of an orientation tolerance, it can move in translation in all the directions with regard to the datum. It is thus necessary to introduce an attribute indicating if the zone can move or not with regard to the datum:

- **FreeToTranslate** = TRUE or FALSE

## 4. REPRESENTATION OF THE TOLERANCED FEATURES AND OF THE DATUMS FEATURES ON THE CAD MODEL OF THE PART

The semantic representation proposed here requires the three-dimensional construction of the toleranced and datum features on the part. These features can already exist on the CAD model of the part or will have to be added by the designer. For example, a axis hole "will be materialized" by a segment of straight line inside the hole with a starting point at "the entry" of the hole and a final point at the "exit" of the hole. This segment will have to be a "child" of the cylindrical face representing the hole, in the meaning of mother/child relation used in CAD systems. It could be prolonged or axially moved if it is the prolongation of the hole which is functional. Thus the standardized concept of projected tolerance can easily be represented.

Sometimes the tolerance concerns only a piece of the face. In this case a surface corresponding to this piece will be added on the model of the part.

## 5. ILLUSTRATION OF THE REPRESENTATION OF A PART TOLERANCING SCHEME

To simplify the presentation, we consider that each geometrical feature of the CAD model has a number. On the figure 7, only the numbers of the features affected by a gauge were indicated. They are the planar faces (1) and (2), the cylindrical faces (3) and

(4) and finally the straight line segment (5) representing the axis of the large hole:

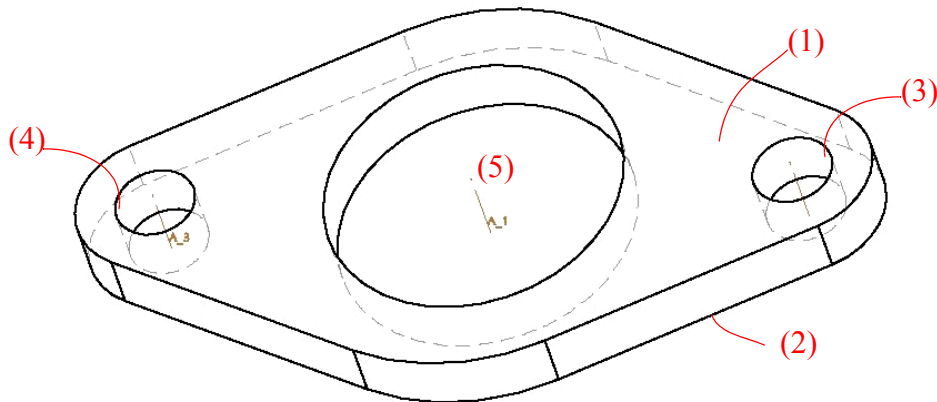

Figure 7; CAD modeling of the part: each feature has an identifier, represented here by a number.

The representation of the four geometric tolerances assigned to this part consists in describing the virtual gauges.

Each virtual gauge is a list of elementary gauges, each one in relation to a geometrical feature of the CAD model of the part. So the first attribute of an elementary gauge is a pointer towards the geometrical feature of the part: **OnFeatureNo**.

According to the type of elementary gauge (**ZoneGauge** or **SurfaceGauge**), the values of its attributes (**TolValue** and **FreeToTranslate** or **Behaviour** and **Size**) are found. The tolerances of the part represented on figure 1, are defined as follows:

```

ToleranceNo1= { ZoneGauge(OnFeatureNo=1; TolValue=0.03; FreeToTranslate= FALSE) };
ToleranceNo2 = { SurfaceGauge(OnFeatureNo=1; Behaviour=PrimFit);
                ZoneGauge(OnFeatureNo=2; TolValue=0.03; FreeToTranslate= TRUE) };
ToleranceNo3 = { SurfaceGauge(OnFeatureNo=1; Behaviour=PrimFit);
                SurfaceGauge(OnFeatureNo=3; Behaviour=Border; Size=7.9) ;
                SurfaceGauge(OnFeatureNo=4; Behaviour=Border; Size=7.9) };
ToleranceNo4 = { SurfaceGauge(OnFeatureNo=1; Behaviour=PrimFit);
                SurfaceGauge(OnFeatureNo=3; Behaviour=SecondFit; Size= "Free") ;
                SurfaceGauge(OnFeatureNo=4; Behaviour=SecondFit; Size= "Free") };
                ZoneGauge(OnFeatureNo=5; TolValue=0.2; FreeToTranslate= FALSE) }
    
```

Figure 8; Illustration of the representation of the geometric tolerances by description of the virtual gauges.



## 6. PROSPECTS FOR THE USE OF THE REPRESENTATION OF TOLERANCES BY VIRTUAL GAUGES

At present, in the majority of the CAD software packages, the tolerance frames are directly created by the user. The compliance with the standardized rules of syntax is in part ensured by the software which limits the possibilities of writing. The semantic coherence of the tolerances, with respect to the parts, is not verified and depends entirely on the expertise of the user.

To our knowledge, at the moment, two software packages are able to generate the tolerance frames, in a quasi-automatic way, starting from the selection, by the user, of the tolerated features and the datum features on the 3D model of the part. Nevertheless the development and the updating of those software packages are delicate because the writing rules of the standardized tolerances are badly formalized and change regularly.

The "virtual tolerancing gauges" could be generated in the same manner: by selecting the tolerated features and the datum features on the 3D model of the part, the user will define the inspecting gauge corresponding to each functional geometrical requirement of the product. These gauges will be displayed in 3D on the model of part (as shown in figures 2 to 4), which will enable the user to directly visualize the meaning of the geometric tolerances, or could be expressed in the form of tolerance frames on the technical drawings according to the standardized graphic languages (ISO or ANSI). Thus the semantic representation of the tolerances gives more possibilities of tolerancing to the user and releases him from the constraints of standardized writing rules. The tolerancing will be more functional and faster to realize.

The representation by gauges allows to define geometric tolerances impossible to express by the today standardized syntax. For example it is impossible to specify a "self-parallelism" tolerance for the two plane faces (1) and (2) of the part (figure 7) with the standardized graphic language. However the gauge corresponding to this requirement could be defined. It will consist of two plane zones each being able to translate in reference to the other. In this case the algorithm for the writing of the gauges in the form of tolerance frames should propose various solutions to the user: either a standardized tolerance which "degrades" the desired tolerance - it is the parallelism tolerance indicated on the drawing of figure 1 - or a less "standardized tolerance" which expresses the gauge as well as possible such as the one proposed on the figure below.

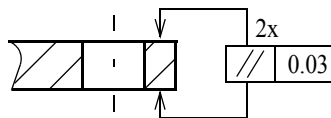

*Figure 9; Instance of non standardized tolerance defining two parallel plane zones.*

Nevertheless we think that the gauge representation could allow to do without the writing of the tolerance frames on drawings in a CAD-CAM environment. Indeed it would be even simpler for the manufacturing designer to see the tolerancing gauges

directly in 3D rather than to have "to decode" tolerance frames on drawings. Many mistakes in the interpretation of tolerances would be thus avoided, during their writing and their reading.

In production, we think that the tolerancing by zones is unsuited because it does not give the separation of the form, orientation and position defects which is necessary to allow to correctly adjust the production process.

Lastly, the prototype software of three-dimensional metrology that we have already developed, shows that it is possible to directly use the fitting gauge model for the verification of the manufactured parts [Pairel, 1997].

## 7. CONCLUSION

The "fitting gauge model" enables to represent, in an extremely simple way, the near total of the standardized geometric tolerances as well as tolerances by zone which are impossible to express in the standardized graphic language.

This representation guarantees the semantic coherence of the tolerances and can be directly used for the dimensional verification of conformity of the products and also by the manufacturing designer.

We think that this model could represent any geometric tolerance by zone. It could be achieved by improving the model and the data-structure. The case of the geometric tolerances of lines (circularity, straightness, profile tolerance of any line) can easily be modelled by creating a line on the surface of the CAD model of the part. The gauge-zone will be related to this line and not to the surface. The most difficult case is the particular case of the zone having a shape different from the one of the toleranced feature. For example it is the case of a cylinder axis having to be contained within a planar zone. In this case, a solution could consist in creating a plane passing through the axis and directed with regard to another geometric feature of the part defining the secondary datum reference. The zone-gauge would be related to this plane.

The other study to be carried out relates to the representation of the dimensional tolerances with or without envelope condition. For the moment we think that the dimensional tolerances can be "carried" by the CAD model of the part, which is already possible with several software packages. We are currently considering testing a such semantic representation in a CAD software package.

## 8. REFERENCES

- [Jayaraman *et al.*, 1989] R. Jayaraman, V. Srinivasan, "Geometric tolerancing: 1. Virtual boundary requirements", IBM Journal of Research and Development, Vol. 33, No. 2, March 1989.
- [Etesami, 1991] Etesami F.; "Position Tolerance Verification Using Simulated Gaging", The International Journal of Robotics Research, Vol. 10, No. 4, 1991.
- [Nigam *et al.*, 1993] S.D. Nigam, J.D. Guilford, J.U. Turner, "Derivation of generalized datum frames for geometric tolerance analysis", ASME Design Automation Conference, Albuquerque, Sept. 1993.
- [Ballu *et al.*, 1997] A. Ballu and L. Mathieu, "Virtual gauge with internal mobilities for verification of functional specifications"; Proceeding of the 5rd CIRP Seminar on Computer Aided Tolerancing, Toronto, Canada, April 27-29; 1997.
- [Dantan *et al.*, 1999] J.Y. Dantan, A. Ballu, "Functional and product specification by Gauge with Internal Mobilities", CIRP Seminar on Computer Aided Tolerancing, University of Twente, Netherlands, March 1999.
- [ASME, 1994] ASME Y14.5M-1994, "Dimensioning and Tolerancing".
- [Pairel *et al.*, 1995] E. Pairel, D. Duret, M. Giordano, "Verification of a group of functional surfaces on Coordinate Measuring Machine", Proceedings of the XIII IMEKO World congress, torino, Italy, Sept. 1995, pp 1670-1675.
- [Kandikjan *et al.*, 2001] T. Kandikjan, J.J. Shah, J.K. Davidson, "A mechanism for validating dimensioning and tolerancing schemes in CAD systems", Computer Aided Design, Volume 33, 2001, pp. 721-737.
- [Hernandez *et al.*, 2002] Hernandez P.; Giordano M., "Outil analytique d'aide au tolérancement géométrique en vue d'intégration en C.A.O.", IDMME 2002, Clermont-Ferrand, France, May 14-16, 2002.
- [Giordano *et al.*, 1999] Giordano M., Pairel E., Samper S., "Mathematical representation of Tolerance Zones", 6th CIRP Inter. seminar on Computer-Aided Tolerancing, Univ. of Twente, Enschede, The Netherlands, 1999.
- [Roy *et al.*, 1999] U. Roy and B. Li, "Representation and interpretation of geometric tolerances for polyhedral objects - II. Size, orientation and position tolerances", Computer-Aided Design, Volume 31, No 4, pp. 273-285, 1999.
- [Davidson *et al.*, 2002] J. K. Davidson, A. Mujezinovic; "A new mathematical model for geometric tolerances as applied to round faces"; Journal of Mechanical Design, Volume 124, Dec. 2002; pp. 609--622.
- [Giordano *et al.*, 2001] M. Giordano, B. Kataya, E. Pairel; "Tolerance analysis and synthesis by means of clearance and deviation spaces", 7th CIRP International Seminar on Computer-Aided Tolerancing; ENS de Cachan, France, 2001, pp. 345-354.
- [Pairel, 1997] E. Pairel; "The "Gauge model": a new approach for coordinate measurement"; Proc. of the XIV IMEKO World Congress, Tampere, Finland, June 1997, pp. 278-283.