



**HAL**  
open science

## Battery powered cost effective TDS logger intended for water testing.

Ioan Alexandru Ivan, Valentin Stihi, Michaela Ivan, C. Stihi, Micky Rakotondrabe, Adrian Jelea

► **To cite this version:**

Ioan Alexandru Ivan, Valentin Stihi, Michaela Ivan, C. Stihi, Micky Rakotondrabe, et al.. Battery powered cost effective TDS logger intended for water testing.. Romanian Journal of Physics, 2011, 56 (3-4), pp.540-549. hal-00635652

**HAL Id: hal-00635652**

**<https://hal.science/hal-00635652v1>**

Submitted on 25 Oct 2011

**HAL** is a multi-disciplinary open access archive for the deposit and dissemination of scientific research documents, whether they are published or not. The documents may come from teaching and research institutions in France or abroad, or from public or private research centers.

L'archive ouverte pluridisciplinaire **HAL**, est destinée au dépôt et à la diffusion de documents scientifiques de niveau recherche, publiés ou non, émanant des établissements d'enseignement et de recherche français ou étrangers, des laboratoires publics ou privés.

## BATTERY POWERED COST EFFECTIVE TDS LOGGER INTENDED FOR WATER TESTING

I. A. IVAN<sup>1,2</sup>, V. STIHI<sup>1</sup>, M. IVAN<sup>1</sup>, C. STIHI<sup>1</sup>, M. RAKOTONDRABE<sup>2</sup>, A. JELEA<sup>3</sup>

<sup>1</sup> Valahia University of Targoviste, B-dul Unirii 18-20, 130082, Targoviste, Romania  
E-mail: ivan@valahia.ro, cstihi@yahoo.com

<sup>2</sup> Femto-ST Institute, AS2M Dpt., 24 Rue Alain Savary, 25000 Besancon, France,  
E-mail: alex.ivan@femto-st.fr

<sup>3</sup> SC Catalyx Engineering, 021388 Bucharest, Romania, E-mail: jelixadrian@gmail.com

*Received October 21, 2009*

The paper presents a cost-effective device designed for measuring and monitoring the TDS (total dissolved solids) level of drinkable, surface (lakes, rivers) and/or industrial waters. Providing a first reading of potential water pollutions, the device is dedicated to the sectors of environment and consumer protection. The device was implemented and a series of continuous measurements is depicted, discovering some abnormalities in the quality of Targoviste city water utility.

*Key words:* water quality, conductivity-meter, TDS, microcontroller.

### 1. INTRODUCTION

In recent years, the need for water quality sensors spread from industry to environment and domestic applications. One of the most direct methods is the TDS (*Total Dissolved Solids*) measurement.

TDS devices are, in reality, conductivity meters. Pure water shows intrinsically a very reduced electrical conductivity (0,00548 mS/m). When impurities are mixed and dissolved into water, ions separate and conductivity increase. Upon application of a voltage between two or more electrodes made of non-reactive materials, positively charged ions (*e.g.* Na<sup>+</sup>, Ca<sup>++</sup>, Mg<sup>++</sup>, H<sup>+</sup> etc.) and negatively charged ions (*e.g.* Cl<sup>-</sup>, SO<sub>4</sub><sup>--</sup>, HCO<sub>3</sub><sup>-</sup> etc.) will constitute an electrical current. The conductivity of water may afterwards be converted into a measure of the total quantity of ions or dissolved solids. The method is not selective, meaning that the nature of ions cannot be determined but only the total quantity, from where the term TDS (*Total Dissolved Solids*). TDS meters also give a relatively accurate reading of some colloidal compounds such as silver [1].

Our device is a modified version of a TDS meter initially designed for the control of a brackish water desalinating system utilizing the novel *capacitive deionization technology* (CDT). This second version of the meter module is

hermetically sealed and is capable to sample, convert and record *in-situ* conductivity, temperature and TDS values over extended periods of time (up to 21 days of logging and with 60 minutes sample interval).

Instead of using DC current, we propose to use an electrical field that oscillates very rapidly, where there is no overall movement of ions toward the electrodes. In fact, the ions move one way for a tiny fraction of a second, and then back the other direction for the second half of the cycle. Overall, the solution and electrodes stay unchanged and the conductivity is accurately measured. Based on 8-bit Microchip PIC18F architecture [4], the devices use a cycle of alternated charging-discharging small capacitors. Threshold voltage detection and derived period of time is made using onboard CMOS trigger and 16-bit counter. The electronic schematic is thus simplified, with no need of A/D converters or voltage references.

Given the fact that the conductivity of ions in water depends nonlinearly upon temperature, the conversion of sampled conductance (mS/cm) in TDS units (ppm) is compensated by aid of internal EEPROM stored look-up tables. The designed TDS device has been calibrated with standard “442” solution, and readings were compared with a commercial Hach CO150 TDS meter. First measurements were carried-out in the city of Targoviste water utility system.

## 2. EXPERIMENTAL METHODS

### 2.1. WATER CONDUCTIVITY MEASUREMENT PRINCIPLE

At a first view, simplistically speaking, water and ions appear as an electric resistance and we might tempt to measure its conductivity in direct current, which is a wrong method. By applying a constant electric field between the two electrodes, ions will migrate and deposit on the electrodes, finally electrically isolating the positive electrode. If the applied voltage is larger than 1.3 volts then the electrolysis phenomena appear between the two electrodes and the conductivity measurement will be completely erroneous.

The measurement of conductivity of liquids may be done in several ways [3], provided that no continuous level of voltage is applied, nor impulse voltage. The frequency of the alternating signal should be larger than 3 kHz, as above this frequency water does not decompose nor plate the electrodes, and as the applied voltage amplitude is no longer limited to 1.3V.

The proposed method is simple and ready to be implemented in logic circuits – no analog circuits being required. A microcontroller PIC18F1220 [4] was chosen for its fast setting of pins state (input/output) and for its symmetry of output ports – they sink and source the same current which is internally limited. The performance of reduced 8-bit architecture is convenient for this type small and low-cost application.

The measurement schematic is shown in the figure 1.  $R_x$  is the unknown water resistance and  $C_1$  is a fixed small capacitor (3,3nF). On the left, C+, C- and EC are some pins of the microcontroller [4] (noted  $\mu C$ ).

The measurement algorithm of the  $R_x$  value is based of the following steps:

1. Pin EC is set as input (high impedance state) then C+ is put on high logic (3V) and pin C- is driven in low state, charging the capacitor very close to the  $V_{cc}$  supply voltage (5V or 3V battery).
2. Pin C+ is set as input and EC pin is set as output on low state. Pin C- continues to stay on low level. Practically C- and EC are “linked to ground” and in this configuration the charged capacitor and water resistance are in parallel and referenced to the ground. The capacitor will discharge following the known exponential decay law. Time constant is proportional to the factor  $R_x \cdot C_1$ .
3. Microcontroller inputs are Schmitt triggers, switching low when the voltage reaches less or equal a 1/3 of supply voltage value. Time of capacitor discharge between  $V_{cc}$  and one third of  $V_{cc}$  is measured and recorded as T1. In the case that T1 exceeds a maximum preset value, T1 will be considered equal to the preset value. This value is determined from the minimum frequency condition of 3 kHz that prevents ions to plate the electrodes. It will only be in the case of ultra-pure water or electrodes outside water, and corresponding TDS value will afterwards be reported as zero.
4. To prepare the next measurement step, pin EC is set to input and pins C- and C+ are set both on high output states. Thus, the capacitor will be completely discharged.
5. Pin C+ is brought to the low state, charging the capacitor to an opposite voltage than that of step (1).
6. Pin C+ direction is set to input (high impedance) and pin EC is set as output (high logic level). In this way,  $R_x$  and  $C_1$  are put in parallel and referenced to  $V_{cc}$ . The discharge time T2 in which the C+ voltage rises to 2/3 of  $V_{cc}$  is measured.
7. Pin EC is set as high impedance, pins C- and C+ are set to low level output. Temperature value is read from the sensor. Next cycle can start from step (1).

A number of 16 cycles will be performed and finally the all-corresponding T1 and T2 time values will be averaged and converted by means of look-up tables stored in EEPROM, as in this case it is conversely proportional to  $R_x$  value.

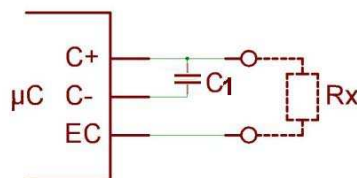

Fig. 1 – Basic measurement schematic.

Two voltage waveforms across Rx (electrodes) are presented in figure 2 for different water resistivities. The curve in magenta is for a higher water conductivity value than that of the grayed curve.

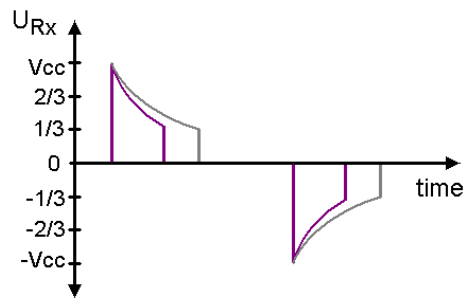

Fig. 2 – Electrodes signal waveforms for two different water conductivities.

The geometry of electrodes is important and has to be respected; otherwise the cell constant  $k$  will change and the device will need to be recalibrated. In our case the electrodes were small stainless steel rods of 1 mm in diameter, of 5 mm in length and placed in parallel at a distance of 3,5 mm between their symmetry axes (figure 3).

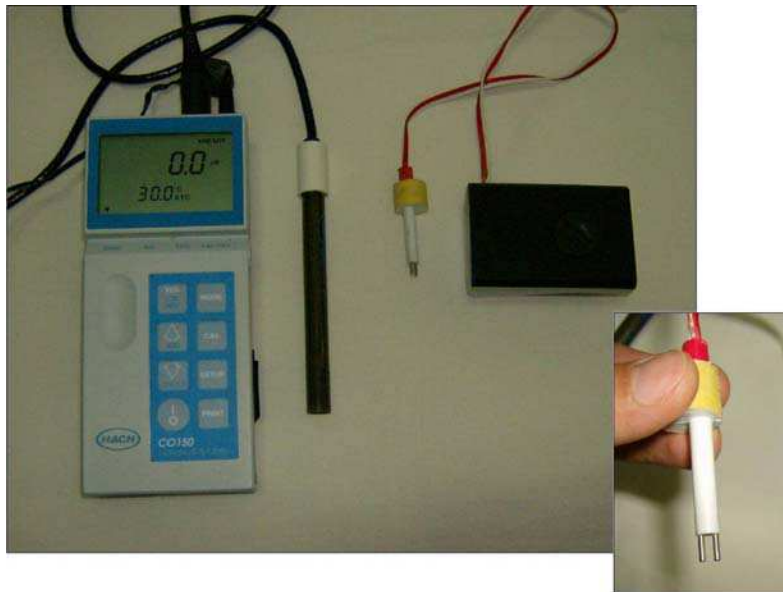

Fig. 3 – Photographs of the reference CO150 conductivity meter and of the designed device.  
Close-up of the sensing probe.

Recalibration is also recommended if tests are performed on different water sources with quite different dissolved compounds. In figure 4 a calibration characteristic is presented. It is known that different conductivities might be reported for different solutions of the same TDS.

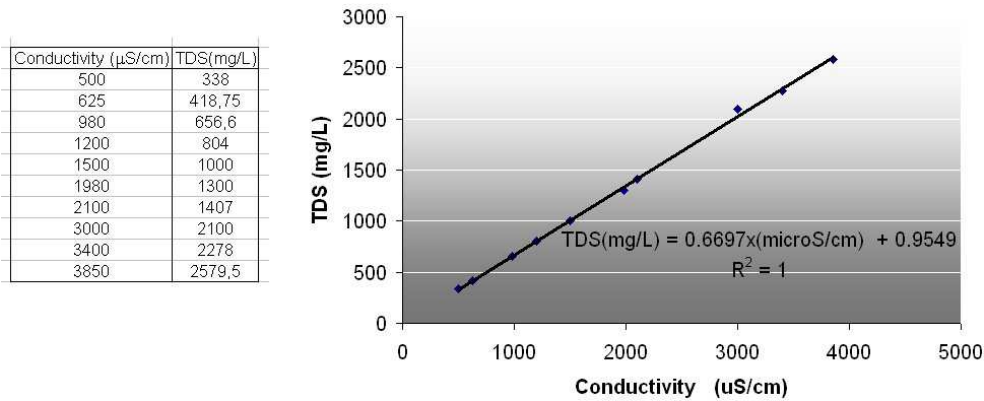

Fig. 4 – TDS measured by device *versus* conductivity measured by the referencing device (in a mixture of KCl+NaCl solutions at 20 °C).

## 2.2. THE BATTERY-POWERED DEVICE: DESIGN AND CALIBRATION

The device is powered from a 3V lithium coin cell battery. Most of the time the device is on the stand-by mode, requiring a very small power supply. The data interface is a simple serial asynchronous (TTL levels) for reading the logged data or writing the calibration table into an external EEPROM or in the internal flash memory. The microcontroller is configured with two oscillators: the first is a 32kHz low power oscillator serving for regularly waking-up the microcontroller from stand-by (60 seconds intervals) and keeping the date and hour, while the second oscillator uses a high speed 10 MHz resonator for the clock source and to count the small time intervals required during acquisition.

Two versions were designed (figures 5-8), the first one is temperature-uncompensated while the second one uses a TC77 temperature sensor featuring internal A/D conversion and SPI interface. In figures 9 and 10 are presented the characteristics conductivity *versus* temperature for the different concentration of the KCl and NaCl standard solutions used in this work. The conversion algorithm implemented on the second device was modified to compensate the readings. As seen, there is a large difference between figures 11 (without reading compensation) and 12 (with reading compensation) taken at different temperature values.

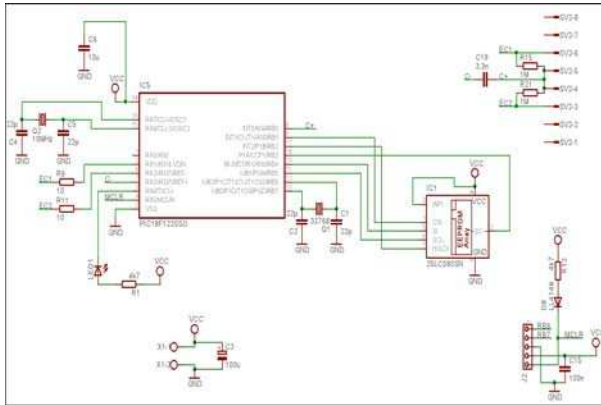

Fig. 5 – Schematic of the first uncompensated model.

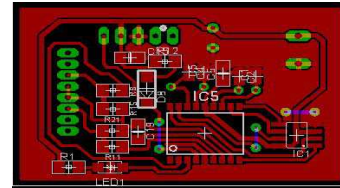

Fig. 6 – Printed circuit board.

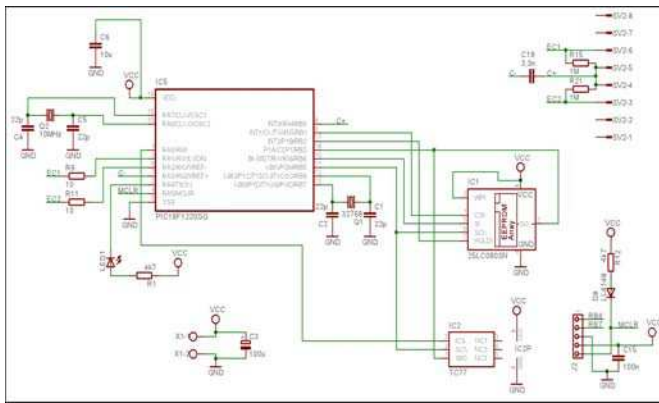

Fig. 7 – Schematic of the second temperature compensated model.

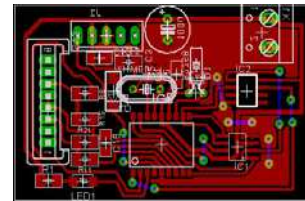

Fig. 8 – Printed circuit board.

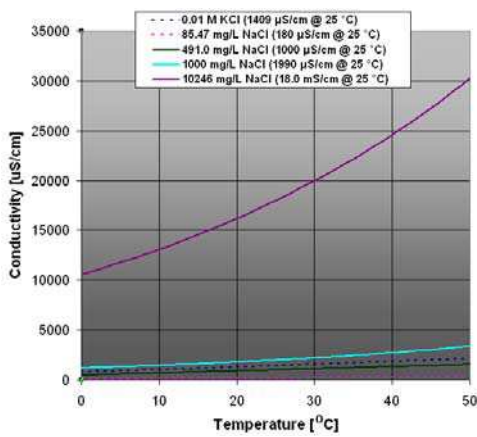

Fig. 9 – Conductivity to temperature characteristics for different concentrations.

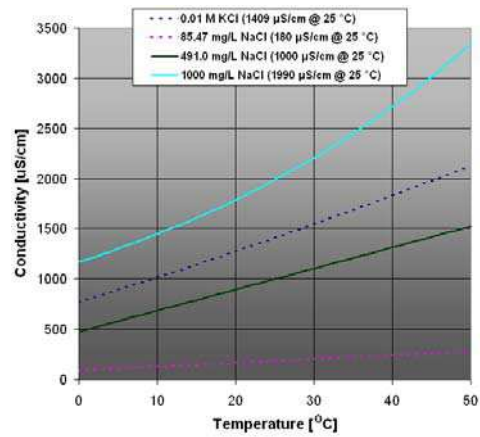

Fig. 10 – Same graph re-scaled.

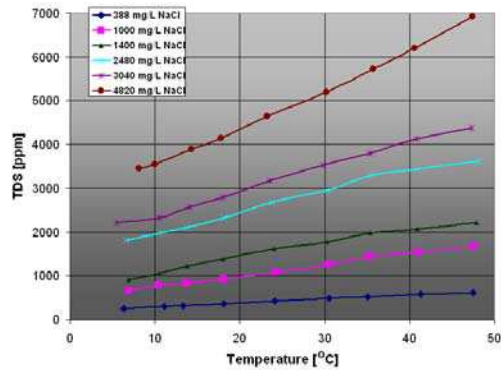

Fig. 11 – Non-compensated model TDS to temperature characteristic.

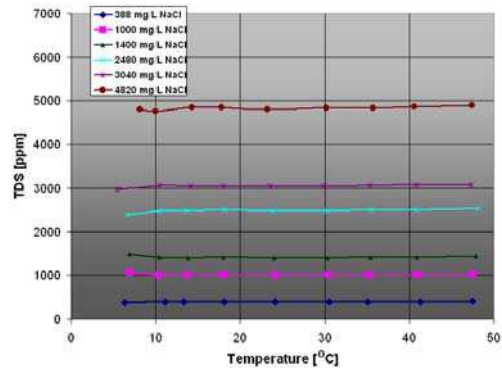

Fig. 12 – Compensated model TDS to temperature characteristic (various concentrations).

### 3. EXPERIMENTAL RESULTS AND DISCUSSIONS

Water plays an intrinsic role in living environment. Water of suitable quality and quantity is essential to all life forms. Water is never in a pure status, it always contains minerals and microorganisms [8,9]. Human activities can contaminate water with various substances. But water should be clean in order to ensure a good health. Actually, some minerals present in water can have benefit consequences. Surface water is an important component of fresh water systems and surface water monitoring [10-12] is essential in attaining a comprehensive understanding of the physical, chemical, and biological characteristics of aquatic systems.

Total Dissolved Solids (TDS) are solids in water that can pass through a filter. Therefore, TDS can be used to measure the amount of material dissolved in water. This material can include carbonate ( $\text{HCO}_3^-$ ), chloride ( $\text{Cl}^-$ ), sulphate ( $\text{SO}_4^{2-}$ ), calcium ( $\text{Ca}^{++}$ ), magnesium ( $\text{Mg}^{++}$ ), sodium ( $\text{Na}^+$ ), potassium ( $\text{K}^+$ ), iron ( $\text{Fe}^{++}$ ,  $\text{Fe}^{+++}$ ), nitrate ( $\text{NO}_3^-$ ) and other ions. A certain level of these ions in water is necessary for aquatic life. However, if TDS concentrations are out of admissible limits, the growth of many aquatic lives can be limited, and death may occur [1]. A high concentration of TDS may also reduce water clarity, contributes to the decrease of photosynthesis, may combine toxic compounds and heavy metals and leads to an increase in water temperature.

Table below presents the normal variation of conductivity for several types of water, according to [2].



Table 1

Conductivity range of common aqueous solutions [2]

Sample Type	Conductivity Range
High Pressure Boiler Water	<0.1 $\mu\text{S}/\text{cm}$ to 0.2 $\mu\text{S}/\text{cm}$
Demineralized Water	1 $\mu\text{S}/\text{cm}$ to 80 $\mu\text{S}/\text{cm}$
Drinking Water	100 $\mu\text{S}/\text{cm}$ to 1 mS/cm
Wastewater	85 $\mu\text{S}/\text{cm}$ to 9 mS/cm
Surface Water	100 $\mu\text{S}/\text{cm}$ to 10 mS/cm
Industrial Process Water	8 mS/cm to 130 mS/cm
Concentrated Acids and Dyes	85 mS/cm to >1000 mS/cm

Experimental measurements were conducted on the water utility system of Targoviste city. Usually, logged data showed minor daily fluctuations within the normal range (figure 13). During the afternoon when the domestic water flow increases, a slight decrease of the TDS level is recorded. We noticed that on the 5<sup>th</sup> of July (day 8 on recordings) at 22 hrs the pumping switched off for a current repair, which lasted until the next day in the morning at 5 AM. As consequence, the recorded level of TDS (figure 14) showed a significant increase, and it took about 30 hours to retrieve the initial level.

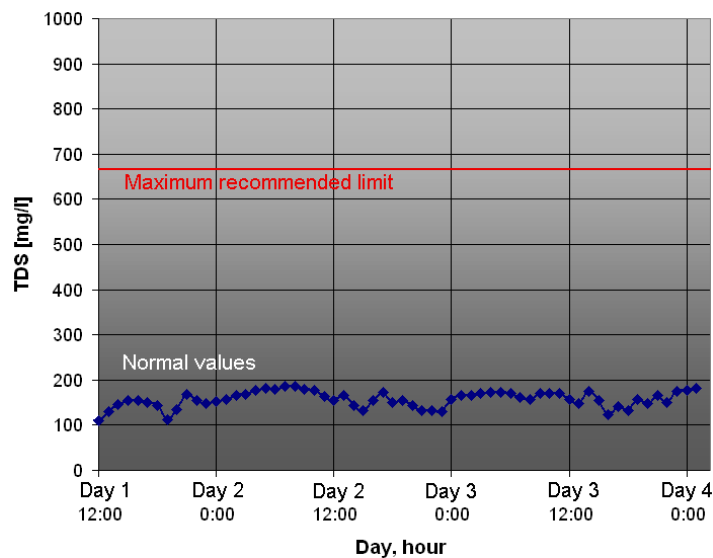

Fig. 13 – Daily normal TDS fluctuations.

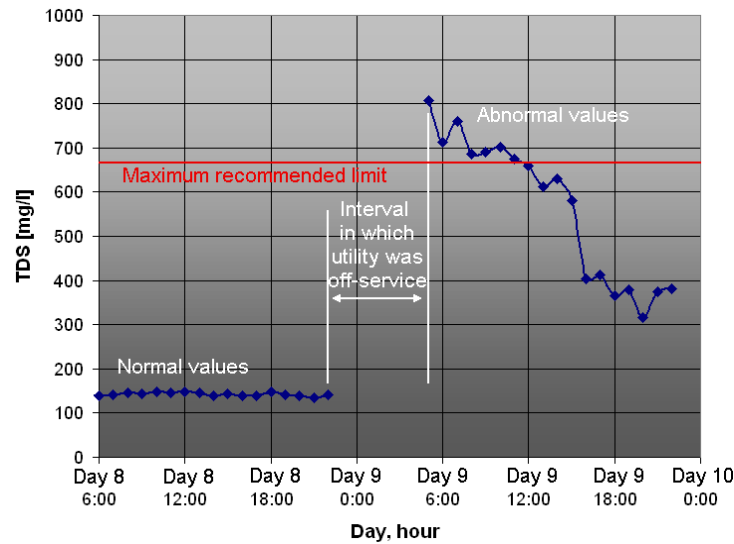

Fig. 14 – Abnormal fluctuation due to the water utility shutdown between 23:00 and 5:00.

## 5. CONCLUSIONS

The aim of this paper was the design and test of a cost-effective TDS logger intended for water quality monitoring. Such battery-powered devices are intended for large scale monitoring, *e.g.* along rivers or in urban water systems. It is based on a 8-bit microcontroller architecture and a small EEPROM memory. An additional temperature sensor allows the reading compensation. Data exchange is performed over a simple SPI serial synchronous interface. Up to 512 readings are possible with the provided memory capacity. The autonomy at a 1 hour sampling rate is of 21 days and it can be easily improved by replacing the memory chip.

First off-line TDS measurements and logs were performed on one end-point of the Targoviste city water utility. The results were within the limits except for a single day when the utility was shut-down for a night for maintenance. In the morning there were noticed abnormally high TDS values. It should be noticed that according to the Romanian standard [6] the maximum allowed level of 2000 mg/l was not attained; however we can notice that the recommended value of 1 mS/cm shown in Table 1 or 670 mg/l was exceeded for a period of 7 hours after the utility resumed the pumping. We appreciate that a utility shutdown of a longer period, let's say of one day, would raise even further the TDS level, making the water undrinkable.

Finally, the developed low cost device for continuous monitoring can provide a quick test of the water quality, preventing unwanted health problems. As further improvements, these devices could be connected in wired or wireless distributed networks for reporting instant alarms.

## REFERENCES

1. Craun GF, McGabe LJ., *Problems associated with metals in drinking water*, Journal of the American Water Works Association, (1975).
2. \*\*\*\*, CO150 Conductivity Meter Model 50150 Instruction Manual, Hach Company, (1998).
3. Singh T, Kalra YP., *Specific conductance method for in situ estimation of total dissolved solids*, Journal of the American Water Works Association, (1975).
4. \*\*\*\*, PIC 18Fxxxx Microcontroller Data Sheet, Microchip Technology Comp. (2005).
5. Wagner, R.E. (ed), *Guide to Environmental Analytical Methods*, 4th edition, Genium Publishing Corporation, Schenectady, NY, (1998).
6. \*\*\*\*, National Standard STAS 4706 For Surface Waters, Quality Categories and Conditions (1988).
7. \*\*\*\*, International Organization for Standardization ISO 7888: Water quality - determination of electrical conductivity, Geneva, (1985).
8. Oprean L., Chicea D., Gaspar E., Lengyel E., *Results of Physical and Chemical Parameters Monitoring of the "Râul Mare" River*, Rom. Journ. Phys., Vol. 53, Nos. 7–8, P. 947–953 (2008).
9. Anton M.C., Baltazar Rojas M.M., Aluculesei A., Marguþa R, Dorohoi, D, *Study Regarding the Water Pollution in Romania and Spain*, Rom. Journ. Phys., Vol. 53, Nos. 1–2, 157–163 (2008).
10. C. Stihî, I. V. Popescu, A. Bancuta, V. Stihî, Gh. Vlaicu, *Inductively Coupled Plasma (ICP) and Total Dissolved Solids (TDS) Measurements of Surface Waters from Ialomîta River*, Romanian Journal of Physics, Vol. 50, Nos. 9–10, 977–981 (2005).
11. Gabriel Dima, Ion V. Popescu, Claudia Stihî, Calin Oros, Sergiu Dinu, Laur manea, Gheorghe Vlaicu, *Fe, Mn and Zn concentration determination from Ialomita river by atomic absorption spectroscopy*, Romanian Journal of Physics, Vol 51, Nos 5–6, 633–638 (2006).
12. Gonca Coskun H., Tanik A., Alganci U., Cigizoglu H.K., *Determination of Environmental Quality of a Drinking Water Reservoir by Remote Sensing, GIS and Regression Analysis*, Water Air Soil Pollut 194:275–285 (2008).