



HAL
open science

Measuring Transient Temperature of the Medium in Power Engineering Machines and Installations

Magdalena Jaremkiwicz, Dawid Taler, Tomasz Sobota

► **To cite this version:**

Magdalena Jaremkiwicz, Dawid Taler, Tomasz Sobota. Measuring Transient Temperature of the Medium in Power Engineering Machines and Installations. *Applied Thermal Engineering*, 2010, 29 (16), pp.3374. 10.1016/j.applthermaleng.2009.05.013 . hal-00634765

HAL Id: hal-00634765

<https://hal.science/hal-00634765>

Submitted on 23 Oct 2011

HAL is a multi-disciplinary open access archive for the deposit and dissemination of scientific research documents, whether they are published or not. The documents may come from teaching and research institutions in France or abroad, or from public or private research centers.

L'archive ouverte pluridisciplinaire **HAL**, est destinée au dépôt et à la diffusion de documents scientifiques de niveau recherche, publiés ou non, émanant des établissements d'enseignement et de recherche français ou étrangers, des laboratoires publics ou privés.

Accepted Manuscript

Measuring Transient Temperature of the Medium in Power Engineering Machines and Installations

Magdalena Jaremkiewicz, Dawid Taler, Tomasz Sobota

PII: S1359-4311(09)00164-1
DOI: [10.1016/j.applthermaleng.2009.05.013](https://doi.org/10.1016/j.applthermaleng.2009.05.013)
Reference: ATE 2815

To appear in: *Applied Thermal Engineering*

Received Date: 23 September 2008
Revised Date: 8 May 2009
Accepted Date: 16 May 2009

Please cite this article as: M. Jaremkiewicz, D. Taler, T. Sobota, Measuring Transient Temperature of the Medium in Power Engineering Machines and Installations, *Applied Thermal Engineering* (2009), doi: [10.1016/j.applthermaleng.2009.05.013](https://doi.org/10.1016/j.applthermaleng.2009.05.013)

This is a PDF file of an unedited manuscript that has been accepted for publication. As a service to our customers we are providing this early version of the manuscript. The manuscript will undergo copyediting, typesetting, and review of the resulting proof before it is published in its final form. Please note that during the production process errors may be discovered which could affect the content, and all legal disclaimers that apply to the journal pertain.

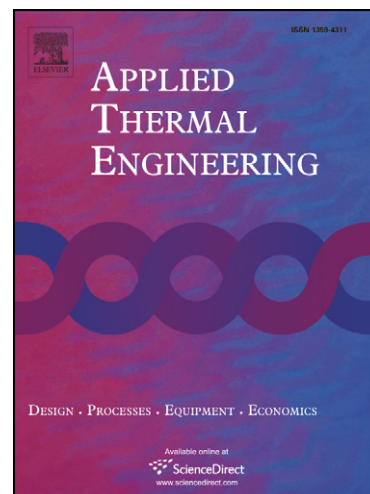

Measuring Transient Temperature of the Medium in Power Engineering Machines and Installations

Magdalena Jaremkiwicz^{*}, Dawid Taler^{**}, Tomasz Sobota^{***}

^{*) ***}) Cracow University of Technology, Division of Power Engineering,

al. Jana Pawła II 37, PL-31-864 Kraków, Poland

^{**}) University of Science and Technology, Department of Power Installations

al. Mickiewicza 30, PL-30-059 Kraków, Poland

^{***}) corresponding author, e-mail: tsobota@mech.pk.edu.pl

Abstract: Under steady-state conditions when fluid temperature is constant, there is no damping and time lag and temperature measurement can be made with high accuracy. But when fluid temperature is varying rapidly as during start-up, quite appreciable differences occur between the true temperature and the measured temperature because of the time required for the transfer of heat to the thermocouple placed inside a heavy thermometer pocket. In this paper, two different techniques for determining transient fluid temperature based on the first and second order thermometer model are presented. The fluid temperature was determined using measured thermometer temperature, which is suddenly immersed into boiling water. To demonstrate the applicability of the presented method to actual data, the air temperature which changes in time, was calculated based on the temperature readings from the sheathed thermocouple.

1. Introduction

Most books on temperature measurement concentrate on steady-state measurements of fluid temperature [1-9]. Only a unit-step response of thermometers is considered to estimate the dynamic error of temperature measurement.

Little attention is paid to measurements of transient fluid temperature, despite the great practical significance of the problem [10-14]. In [7] a thermocouple compensating network is applied to increase the frequency response of the thermocouple. The disadvantage of the compensating network is that it reduces the thermocouple output and is appropriate for the time independent time constant. When a temperature measurement is conducted under unsteady conditions, it is of great importance that the dynamic measurement errors should be taken into account [12, 13]. If the dynamic response of the thermometers had been modelled then the better agreement between the experimental data and model predictions would have been achieved.

The measurement of the transient temperature of steam or flue gases in thermal power stations is very difficult. Massive housings and low heat transfer coefficient cause the actually measured temperature to differ significantly from the actual temperature of the fluid.

Some particularly heavy thermometers may have time constants of 3 minutes or more, thus requiring about 15 minutes to settle for a single measurement.

There are some thermometer designs where there is more than one time constant involved. In order to describe the transient response of a temperature sensor immersed in a thermowell, the measuring of the medium in a controlled process may have two or three time constants which characterise the transient thermometer response.

The problem of a dynamic error during the measuring of the temperature of the superheated steam is particularly important for the superheated steam temperature control systems which use injection coolers. Due to a large inertia of the thermometer, a correct measurement of the transient temperature of the fluid, and thus the automatic control of the superheated steam temperature is far from perfect. A similar problem is

encountered in flue gas temperature measurements, since the thermometer time constant and time delay are large.

In this paper two methods of determining the changing in time temperature of the flowing fluid on the basis of the temperature time changes indicated by the thermometer are presented.

In the first method the thermometer is considered to be a first order inertia device and in the second method it is considered to be a second order inertia device. A local polynomial approximation, based on 9 points was used for the approximation of the temperature changes. This assures that the first and the second derivative from the function representing the thermometer temperature changes in time will be determined accurately.

An experimental analysis of the industrial thermometer at the step increase of the fluid temperature was conducted. A comparison was made between the temperature time histories determined using the two proposed methods at the step increase of the fluid temperature were compared.

2. Mathematical models of the thermometers

Usually the thermometer is modelled as an element of the concentrated thermal capacity. In this way, it is assumed that the temperature of the thermometer is only the function of time and temperature differences occurring within the thermometer are neglected. The temperature changes of the thermometer in time $T(t)$ have been described by an ordinary first order differential equation (first order thermometer model)

$$\tau \frac{dT}{dt} + T = T_{cz} . \quad (1)$$

For thermometers with a complex structure used for measuring the temperature of the fluid under high pressure, the accuracy of the first order model (1) is inadequate.

3. Thermometer of a complex structure

To demonstrate that a dynamic response of a temperature sensor placed in a housing may be described by a second-order differential equation, a simple thermometer model shown in Fig. 1 will be considered.

An air gap can appear between the external housing and the temperature sensor. The thermal capacity of this air gap $c \cdot \rho$ is neglected due to its small value (Fig. 1).

Introducing the overall heat transfer coefficient k_w referenced to the internal surface of the housing and accounting for the radiation heat transfer from the housing to the inner sensor, we obtain:

$$\frac{1}{k_w} = \frac{1}{\alpha_w} + \frac{(1 + D_w/d)(D_w - d)}{4\lambda_p} + \frac{D_w}{d} \cdot \frac{1}{\alpha_T}. \quad (2)$$

The heat balance equation for the sensor located within the housing assumes the form:

$$A\rho c \frac{dT}{dt} = P_w k_w (T_o - T) + C(T_o^4 - T^4), \quad (3)$$

where

$$C = \frac{\pi d \sigma}{\frac{1}{\varepsilon_T} + \frac{d}{D_w} \left(\frac{1}{\varepsilon_o} - 1 \right)}.$$

Introducing the overall heat transfer coefficient k_z for the housing referenced to its external surface, we obtain:

$$\frac{1}{k_z} = \frac{1}{\alpha_z} + \frac{1 + D_z/D_w}{2} \cdot \frac{\delta_o}{\lambda_o}. \quad (4)$$

The formulas (2) and (4) for the overall heat transfer coefficients were derived using the basic principles of heat transfer [2, 4, 8]. The heat transfer equation for the housing (thermowell) can be written in the following form:

$$A_o \rho_o c_o \frac{dT_o}{dt} = P_z k_z (T_{cz} - T_o) - P_w k_w (T_o - T) - C(T_o^4 - T^4). \quad (5)$$

In the analysis of the heat exchange between the housing and the thermocouple the radiation heat transfer will also be disregarded. Such a situation occurs, when a gap between the housing and temperature sensor is filled with non-transparent substance or one of the two emissivities ε_o and ε_T is close to zero.

After determining the temperature T_o from Eq.(3), we obtain:

$$T_o = \frac{A \rho c}{P_w k_w} \frac{dT}{dt} + T. \quad (6)$$

Substituting Eq. (6) into Eq. (5) yields

$$\frac{(A_o \rho_o c_o)(A \rho c)}{(P_w k_w)(P_z k_z)} \frac{d^2 T}{dt^2} + \frac{A_o \rho_o c_o}{P_z k_z} \left[1 + \frac{(P_z k_z)(A \rho c)}{(P_w k_w)(A_o \rho_o c_o)} + \frac{A \rho c}{A_o \rho_o c_o} \right] \frac{dT}{dt} + T = T_{cz}. \quad (7)$$

Let us next to define the following coefficients in Eq. (7)

$$a_2 = \frac{(A_o \rho_o c_o)(A \rho c)}{(P_w k_w)(P_z k_z)}, \quad a_1 = \frac{A_o \rho_o c_o}{P_z k_z} \left[1 + \frac{(P_z k_z)(A \rho c)}{(P_w k_w)(A_o \rho_o c_o)} + \frac{A \rho c}{A_o \rho_o c_o} \right], \quad a_0 = 1, \quad b_0 = 1,$$

to obtain the ordinary differential equation of the second order

$$a_2 \frac{d^2 T}{dt^2} + a_1 \frac{dT}{dt} + T = T_{cz}. \quad (8)$$

The initial conditions assume the form of:

$$T(0) = T_o = 0, \quad \left. \frac{dT(t)}{dt} \right|_{t=0} = v_T = 0. \quad (9)$$

The initial problem (8-9) was solved using the Laplace transformation. The operator transmittance $G(s)$ assumes the following form:

$$G(s) = \frac{\bar{T}(s)}{\bar{T}_{cz}(s)} = \frac{1}{(\tau_1 s + 1)(\tau_2 s + 1)}. \quad (10)$$

The time constants τ_1 and τ_2 are determined using the formula:

$$\tau_{1,2} = \frac{2a_2}{a_1 \pm \sqrt{a_1^2 - 4a_2}}. \quad (11)$$

The differential Equation (8) can be written in the following form:

$$\tau_1 \tau_2 \frac{d^2 T}{dt^2} + (\tau_1 + \tau_2) \frac{dT}{dt} + T = T_{cz}. \quad (12)$$

For the step increase of the fluid temperature from 0 to the constant value T_{cz} the

Laplace transform of the fluid temperature assumes the form: $\bar{T}_{cz}(s) = \frac{T_{cz}}{s}$ and the

transmittance formula can be simplified to:

$$\frac{\bar{T}(s)}{T_{cz}} = \frac{1}{s(\tau_1 s + 1)(\tau_2 s + 1)}. \quad (13)$$

After writing Eq. (12) in the form:

$$\frac{\bar{T}(s)}{T_{cz}} = \frac{1}{s} + \frac{\tau_1}{\tau_2 - \tau_1} \cdot \frac{1}{\left(s + \frac{1}{\tau_1}\right)} - \frac{\tau_2}{\tau_2 - \tau_1} \cdot \frac{1}{\left(s + \frac{1}{\tau_2}\right)} \quad (14)$$

it is easy to find the inverse Laplace transformation and determine the thermometer temperature as a function of time:

$$u(t) = \frac{T(t)}{T_{cz}} = 1 + \frac{\tau_1}{\tau_2 - \tau_1} \exp\left(-\frac{t}{\tau_1}\right) - \frac{\tau_2}{\tau_2 - \tau_1} \exp\left(-\frac{t}{\tau_2}\right). \quad (15)$$

For the first order model the thermometer response for a unit step fluid temperature change is determined by the simple expression:

$$u(t) = 1 - \exp\left(-\frac{t}{\tau}\right). \quad (16)$$

If we assume in Eq. (15) $\tau_2 = 0$ then we obtain Eq. (16) with $\tau = \tau_1$.

In the time response of a first order system, given by Eq. (16), there is no a time delay (a dead time). Heavy thermometers for measuring fluid temperature at high pressure involve a time delay between the temperature sensor output and the fluid temperature changes. The second order thermometer model is appropriate to describe the response behaviour with a time delay.

The time constant τ in Eq. (16) or time constants τ_1 and τ_2 in Eq. (15) will be estimated from experimental data.

The fluid temperature can be determined on the basis of measured histories of the thermometer temperature $T(t)$ and known time constants τ_1 i τ_2 .

The changing in time fluid temperature $T_{cz}(t)$ can be determined from Eq. (1) or Eq. (12) after a priori determination of the time constant τ or time constants τ_1 and τ_2 – respectively. The thermometer temperature changes $T(t)$, the first and second order time derivatives from the function $T(t)$ can be smoothed using the formulas [3]:

$$\begin{aligned} T(t) = & \frac{1}{693} \cdot [-63f(t-4 \cdot \Delta t) + 42f(t-3 \cdot \Delta t) + \\ & + 117f(t-2 \cdot \Delta t) + 162f(t-\Delta t) + 177f(t) + 162f(t+\Delta t) + \\ & + 117f(t+2 \cdot \Delta t) + 42f(t+3 \cdot \Delta t) - 63f(t+4 \cdot \Delta t)] \end{aligned} \quad (17)$$

$$\begin{aligned} T'(t) = & \frac{dT(t)}{dt} = \frac{1}{1188\Delta t} \cdot [86f(t-4 \cdot \Delta t) - 142f(t-3 \cdot \Delta t) - \\ & - 193f(t-2 \cdot \Delta t) - 126f(t-\Delta t) + 126f(t+\Delta t) + \\ & + 193f(t+2 \cdot \Delta t) + 142f(t+3 \cdot \Delta t) - 86f(t+4 \cdot \Delta t)] \end{aligned} \quad (18)$$

$$T''(t) = \frac{d^2T(t)}{dt^2} = \frac{1}{462(\Delta t)^2} \cdot [28f(t-4\cdot\Delta t) + 7f(t-3\cdot\Delta t) - 8f(t-2\cdot\Delta t) - 17f(t-\Delta t) - 20f(t) - 17f(t+\Delta t) - 8f(t+2\cdot\Delta t) + 7f(t+3\cdot\Delta t) + 28f(t+4\cdot\Delta t)], \quad (19)$$

in order to eliminate, at least partially, the influence of random errors in the thermometer temperature measurements $T(t)$ on the determined fluid temperature $T_{cz}(t)$. The symbol $f(t)$ in Eq. (17-19) denotes the temperature indicated by the thermometer and Δt is a time step.

If measured temperature histories are not too noisy, the first and second order can be approximated by the central difference formulas

$$T'(t) = \frac{f(t+\Delta t) - f(t-\Delta t)}{2\Delta t}, \quad (20)$$

$$T''(t) = \frac{f(t+\Delta t) - 2f(t) + f(t-\Delta t)}{(\Delta t)^2}. \quad (21)$$

Equation (1) and Equation (2) can also be used for determining fluid temperature T_{cz} when the time constants of the thermocouple τ or τ_1 and τ_2 are a function of fluid velocity u .

After substituting the time constant $\tau(w)$ into Eq. (1) we can determine fluid temperature $T_{cz}(t)$ for different fluid velocities using the proposed method.

4. Experimental determination of time constants

The method of least squares was used to determine the time constants τ_1 and τ_2 in Eq. (15) or the time constant τ in Eq. (16). The values for the time constants are found by minimising the function S

$$S = \sum_{i=1}^N [u_m(t_i) - u(t_i)]^2 = \min, \quad (22)$$

where $u(t)$ is the approximating function given by Eq. (15) or Eq. (16). The symbol N denotes the number of measurements $(t_i, u_m(t_i))$. That is, the sum of the squares of the deviations of the measured values $u_m(t_i)$ from the fitted values $u(t_i)$ is minimized. Once the time constants τ_1 and τ_2 or τ have been determined they can be substituted into Eq. (22) to find the value for S_{\min} .

The uncertainties in the calculated time constants τ_1 and τ_2 or in τ are estimated using the mean square error

$$s_N = \sqrt{\frac{S_{\min}}{N - m}}, \quad (23)$$

where m is the number of time constants ($m = 2$ for Eq. (15) and $m = 1$ for Eq. (16)).

Based on the calculated mean square error s_N , which is an approximation of the standard deviation, the uncertainties in the determined time constants can be calculated using TableCurve software [18].

5. Determining the fluid temperature on the basis of time changes in the thermometer temperature

An industrial thermometer (Fig. 2) at the ambient temperature was suddenly immersed into hot water with saturation temperature. The thermometer temperature data was collected using the Hottinger-Baldwin Messtechnik data acquisition system. The measured temperature changes were approximated using functions (15) and (16). The time constant τ in Eq. (16) and time constants τ_1 and τ_2 in function (15) were determined using the TableCurve 2D code [18]. The following values with the 95 %

confidence uncertainty were obtained: $\tau = 14.07 \pm 0.39$ s, $\tau_1 = 3.0 \pm 0.165$ s, and $\tau_2 = 10.90 \pm 0.2$ s.

Next, the fluid temperature changes were determined from Eq. (1) for the first order model and from Eq. (12) for the second order model (Fig. 3). The time step Δt was 1.162 s.

The analysis of the results presented in Fig. 3 indicates that the second order model delivers more accurate results.

The same tests were repeated for sheathed thermocouple with outer diameter 1.5 mm and the results are presented in Fig. 4. The estimated value of the time constant and the uncertainty at 95 % confidence are: $\tau = 1.54 \pm 0.09$ s. As the thermocouple is thin, then Eq. (16) was used as the function approximating the transient response of the thermocouple. First, the transient fluid temperature $T_{cz} = u(t)$ was calculated using Eq. (1) together with Eqs. (17) i (18). Then, the raw temperature data was used. The first order time derivative dT/dt in Eq. (1) was calculated the central difference quotient (20). The inspection of the results displayed in Fig. 4 indicates, that both approaches give practically the same results.

The thermocouple time constant τ for various air velocities w , were determined in the open benchtop wind tunnel (Fig. 5). The WT4401-S benchtop wind tunnel is designed to give a uniform flow rate over 100 mm \times 100 mm test cross section [17].

The experimental data points displayed in Fig. 6 were approximated by the least squares method. The following function was obtained:

$$\tau = \frac{1}{a + b\sqrt{w}}, \quad (24)$$

where τ is expressed in s, and w in m/s.

The best estimates for the constants a and b , with the 95 % confidence uncertainty in the results, are: $a = 0.009526 \pm 0.001405$ 1/s and $b = 0.063436 \pm 0.002338$ (m·s)^{-1/2}.

The variations of the thermocouple time constant τ with the fluid velocity for the sheathed thermocouple with the outer diameter of 1.5 mm are shown in Fig. 6.

The time constant of the thermocouple $\tau = m_T c / (\alpha_T A_T)$ depends strongly on the heat transfer coefficient α_T on the outer thermometer surface, which in turn is a function of the air velocity [19]. In order to demonstrate the applicability of the presented method to actual data, the air temperature $T_{cz}(t)$ in the wind tunnel will be determined based on the measured air temperature with the sheathed K-thermocouple with an outer diameter of 1.5 mm. The flowing air was heated by the plate fin and tube heat exchanger. The air velocity w and thermocouple temperature are shown in Figs 7 and 8. The time constant τ was calculated using Eq. (24). The air temperature $T_{cz}(t)$ was determined from Eq. (1). The time derivative dT/dt in Eq. (1) was calculated using Eq. (18) (9-point moving averaging filter) or Eq. (20) (central difference quotient).

The coincidence of the obtained results is very good (Fig. 8).

The measured temperature $T(t)$ was not too noisy, so, the time derivative dT/dt in Eq. (1) might be calculated using the central difference approximation (20) to give the smooth air temperature history (Fig. 8).

It can be seen that the calculated air temperature $T_{cz}(t)$ differ significantly from the temperature $T(t)$ indicated by the thermocouple (Fig. 9) as the time constant $\tau(t)$ is large.

6. Conclusions

Both methods of measuring the transient temperature of the fluid presented in this paper can be used for the on-line determining fluid temperature changes as a function of time.

The first method in which the thermometer is modelled using the ordinary, first order differential equation is appropriate for thermometers which have very small time constants. In such cases the delay of the thermometer indication is small in reference to the changes of the temperature of the fluid. For industrial thermometers, designed to measure temperature of fluids under a high pressure there is a significant time delay of the thermometer indication in reference to the actual changes of the fluid temperature. For such thermometers the second order thermometer model, allowing for modelling the signal delay, is more appropriate. Large stability and accuracy of the determination of the actual fluid temperature on the basis of the time temperature changes indicated by the thermometer can be achieved by using a 9 point digital filter.

Fluid temperature changes obtained using the two described methods were compared. It was established that the thermometer model of the second order gave better results for the industrial thermometer with the large thermowell. The techniques proposed in the paper can also be used, when time constants are functions of fluid velocity.

Nomenclature

- A – surface area of the thermocouple cross section, m^2 ,
- A_o – surface area of the housing cross section, m^2 ,
- A_T – outer surface area of the thermocouple, m^2 ,
- c – average specific heat of the thermocouple, $J/(kg \cdot K)$,
- c_o – average specific heat of the housing, $J/(kg \cdot K)$,
- d – outer diameter of the thermocouple, m ,
- D_w – inner diameter of the housing, m ,

- D_z – outer diameter of the housing, m,
- k_w – overall heat transfer coefficient between the housing inner surface and outer surface of the thermocouple referenced to the inner housing surface, $W/(m^2 \cdot K)$
- k_z – overall heat transfer coefficient between the fluid and the housing referenced to the outer housing surface, $W/(m^2 \cdot K)$
- m_T – thermocouple mass, kg
- P_w – perimeter of the internal surface of the housing, m,
- s – complex variable,
- T_{cz} – fluid temperature, °C,
- T_o – housing temperature, °C,
- T_0 – initial thermometer temperature, °C,
- $\bar{T}_{cz}(s)$ – Laplace transform of the fluid temperature,
- $\bar{T}(s)$ – Laplace transform of the thermometer temperature
- u – unit-step response of the thermometer,
- w – air velocity, m/s

Greek symbols

- α_T – heat transfer coefficient on the outer surface of the thermocouple, $W/(m^2 \cdot K)$,
- α_w – heat transfer coefficient on the inner surface of the housing, $W/(m^2 \cdot K)$,
- α_z – heat transfer coefficient on the outer surface of the housing, $W/(m^2 \cdot K)$,
- δ_o – housing thickness, m,
- ε_o – emissivity of the housing inner surface,
- ε_T – emissivity of the thermocouple surface,

- λ_o – housing thermal conductivity, W/(m·K),
- λ_p – thermal conductivity of the air gap, W/(m·K),
- ρ – average density of the thermocouple, kg/m³,
- ρ_o – average density of the housing, kg/m³,
- σ – Stefan-Boltzmann constant, $\sigma = 5.67 \cdot 10^{-8}$ W/(m²·K⁴),
- τ – time constant of the thermometer in the first order model, s,
- τ_1, τ_2 – time constants of the thermometer in the second order model, s

References

- [1] J. V. Nicholas, D. R. White, Traceable Temperatures. An Introduction to Temperature Measurement and Calibration, Second Edition, John Wiley & Sons, New York, 2001, 140-145.
- [2] L. Michalski, K. Eckersdorf and J. McGhee, Temperature Measurement, Wiley, Chichester, 1991, 251-316.
- [3] S. Wiśniewski, Temperature Measurement in Engines and Thermat Facilities, WNT, Warszawa, 1983, 281-335 (in Polish).
- [4] J. Taler, Theory and Practice of Identification of Heat Transfer Processes, Zakład Narodowy imienia Ossolińskich, Wrocław, 1995, 38-90 (in Polish).
- [5] Z. Kabza, K. Kostyrko, S. Zator, A. Łobzowski, W. Szkolnikowski, Room Climate Control, Agenda Wydawnicza, Pomiary Automatyka Kontrola, Warszawa, 2005, 58-75 (in Polish).
- [6] M. W. Jarvis, D. A. L. Clinch, J. M. Wignall, K. J. Bradburry, R. F. E. Crump, J. Grant, J. W. Tootell, G. H. D. Keen, J. Jenkinson, N. Broadhead, Control and

- Instrumentation, in: *Modern Power Station Practice*, Pergamon Press, Oxford, 1991, 110-142.
- [7] J. P. Holman, *Experimental Methods for Engineers*, McGraw-Hill, Boston, 2001, 399-404.
- [8] O. A. Gerashchenko, A. N. Gordov, V. I. Lakh, B. I. Stadnyk, N. A. Yaryshev, *Temperature Measurement*, Naukova dumka, Kiev, 1984, 66-73 (in Russian).
- [9] J. C. Han, S. Dutta, S. V. Ekkad, *Turbine Heat Transfer and Cooling Technology*, Taylor & Francis, New York, 2000, 531-584.
- [10] V. Székely, S. Röss, A. Poppe, S. Török, D. Magyari, Zs. Benedek, K. Torki, B. Courtois, M. Rencz, *New approaches in the transient thermal measurements*, *Microelectronics Journal* 31 (2000) 727–733.
- [11] D. S. Crocker, M. Parang, *Unsteady temperature measurement in an enclosed thermoconvectively heated air*, *Int. Comm. Heat Mass Transfer*, Vol. 28, No. 8, (2001) 1015-1024.
- [12] A. Mawire, M. McPherson, *Experimental and simulated temperature distribution of oil-pebble bed thermal energy storage system with a variable heat source*, *Applied Thermal Engineering* 29 (2009) 1086-1095.
- [13] Z. Li, M. Zheng, *Development of a numerical model for the simulation of vertical U-tube ground exchangers*, *Applied Thermal Engineering* 29 (2009) 920-924.
- [14] P. C. Chau, *Process Control. A First Course with MATLAB*, Cambridge University Press, Cambridge, 2002, 44-63.
- [15] ASME: *Policy on reporting uncertainties in experimental measurements and results*, *ASME Journal of Heat Transfer* 122 (2000), 411-413.

- [16] R. J. Moffat, Describing the uncertainties in experimental results, *Experimental Thermal and Fluid Science* 1 (1988), 3-17.
- [17] S. Sanitjai, R. J. Goldstein, Forced convection heat transfer from a circular cylinder in crossflow to air and liquids, *International Journal of Heat and Mass Transfer* 47 (2004), 4795-4805.
- [18] TableCurve 2D v. 5.0, Automated Curve Fitting & Equation Discovery, AISN Software Inc., 2000.
- [19] WT4401-S & WT4401-D Benchtop Wind Tunnels, Omega, Stamford, CT, USA, <www.omega.com> visited 06.05.2009.

List of figures

Fig. 1. Cross section through the temperature sensor together with the housing

Fig. 2. Diagram of the industrial thermometer and its dimensions: $D = 18$ mm, $l = 65$ mm, $L = 140$ mm

Fig. 3. Fluid and thermometer temperature changes determined from the first order equation (1) and from the second order equation (12)

Fig. 4. Fluid and thermometer temperature changes determined from the first order Equation (1) for the sheathed thermocouple with outer diameter 1.5 mm

Fig. 5. Benchtop wind tunnel used for determining thermocouple time constant.

Fig. 6. Time constant of sheathed thermocouple with outer diameter of 1.5 mm as a function of air velocity with 95 % confidence intervals

Fig. 7. Air velocity w and time constant τ as a function of time

Fig. 8. Thermocouple and air temperatures: 1 - thermocouple temperature obtained from measurement; 2 - air temperature $T_{cz}(t)$, time derivative dT/dt in Eq. (1) approximated by nine-point moving average filter; 3 – air temperature $T_{cz}(t)$, time derivative dT/dt in Eq. (1) approximated by central difference quotient

Fig. 9. Temperature difference $e = T_{cz} - T$ between air temperature T_{cz} and temperature T indicated by thermocouple: 1 – time derivative dT/dt in Eq. (1) approximated by nine-point moving average filter; 2 - time derivative dT/dt in Eq. (1) approximated by central difference quotient

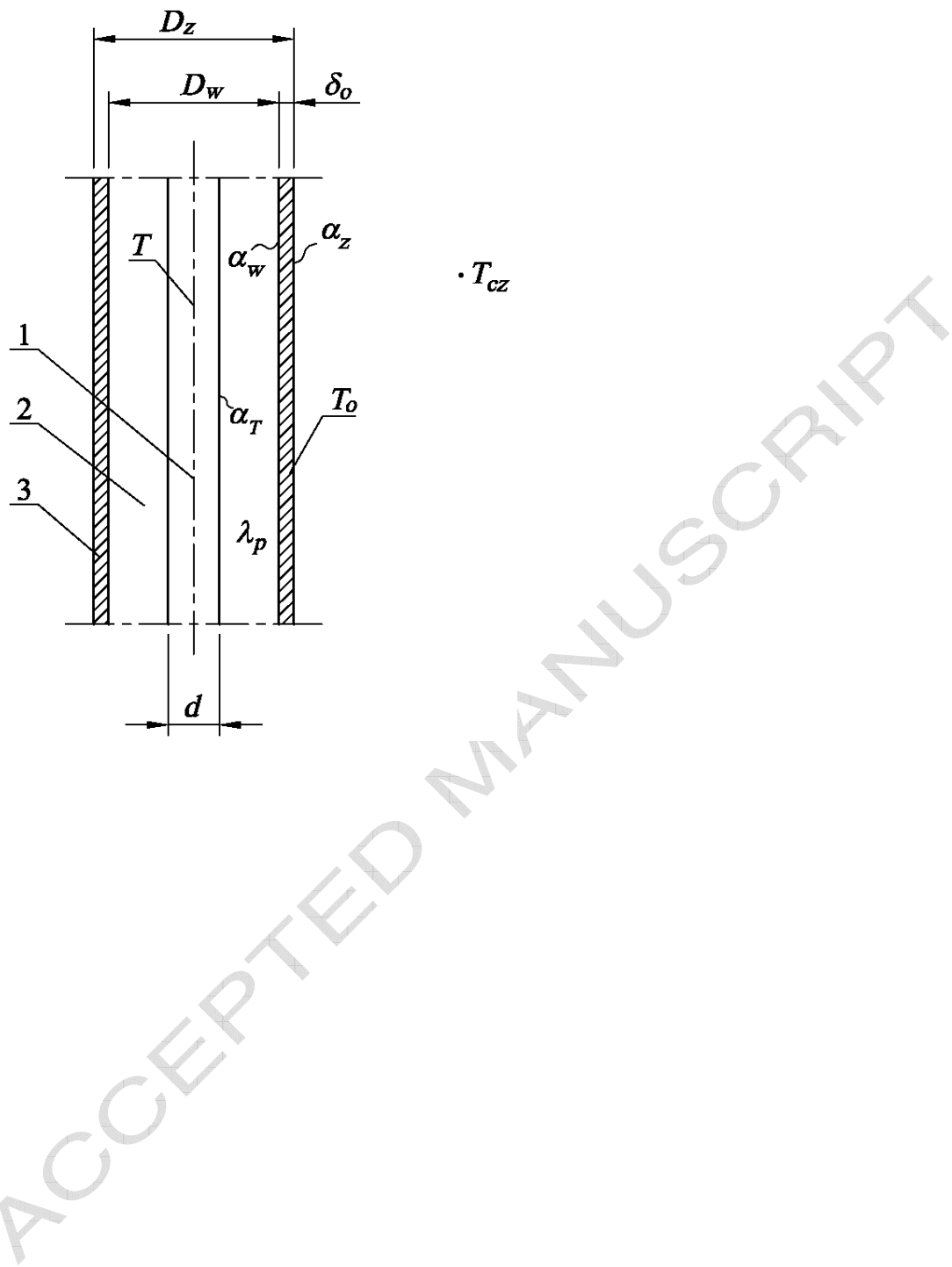

Fig. 1. Cross section through the temperature sensor together with the housing

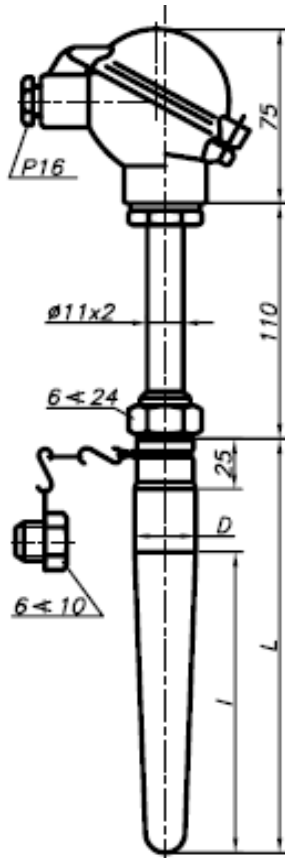

Fig. 2. Diagram of the industrial thermometer and its dimensions: $D = 18$ mm, $l = 65$ mm, $L = 140$ mm

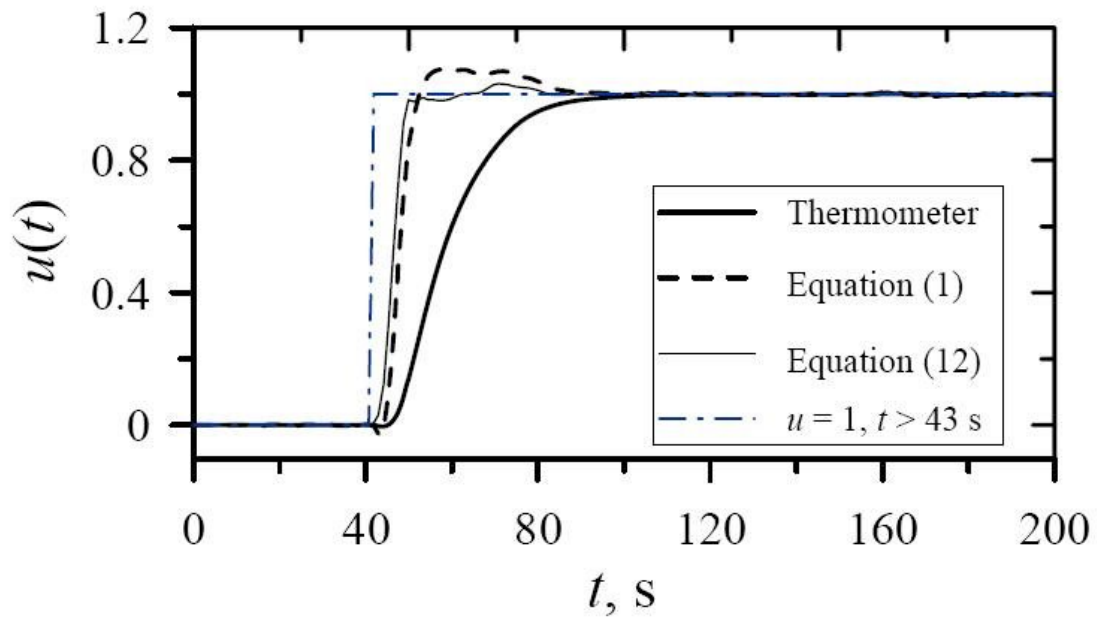

Fig. 3. Fluid and industrial thermometer temperature changes determined from the first order equation (1) and from the second order equation (12)

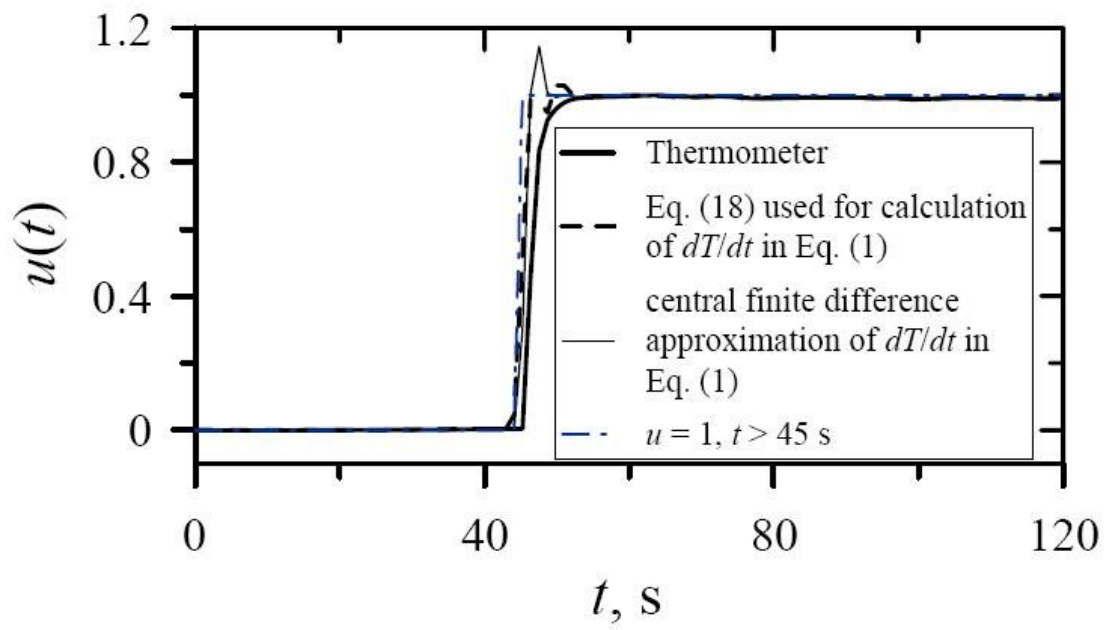

Fig. 4. Fluid and thermometer temperature changes determined from the first order Equation (1) for the sheathed thermocouple with outer diameter 1.5 mm



Fig. 5. Benchtop wind tunnel used for determining thermocouple time constant

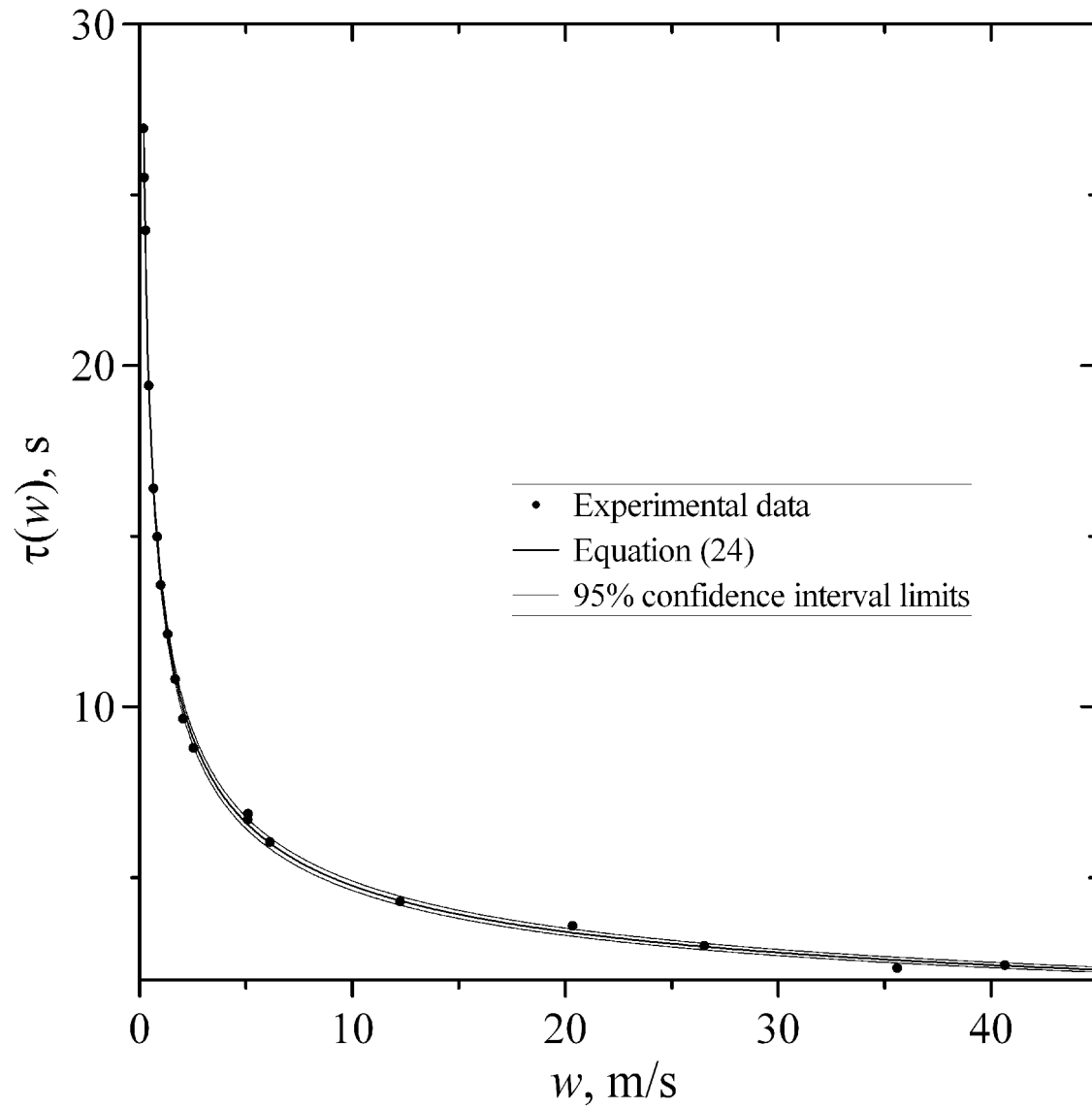

Fig. 6. Time constant of sheathed thermocouple with outer diameter of 1.5 mm as a function of air velocity with 95 % confidence intervals

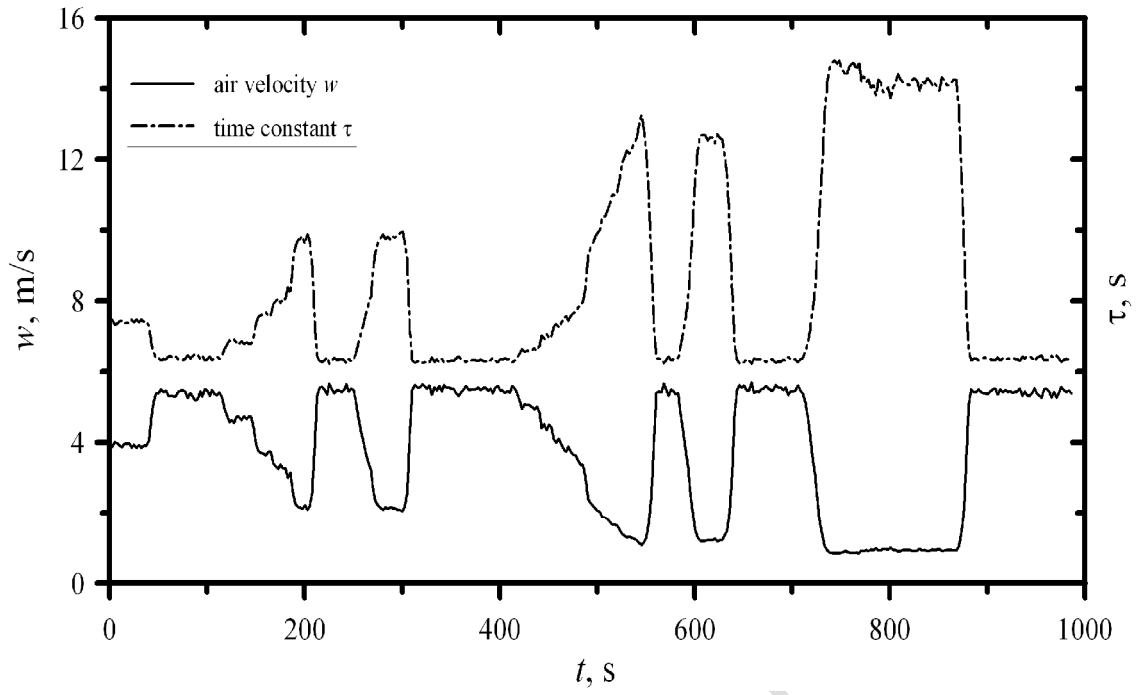

Fig. 7. Air velocity w and time constant τ as a function of time

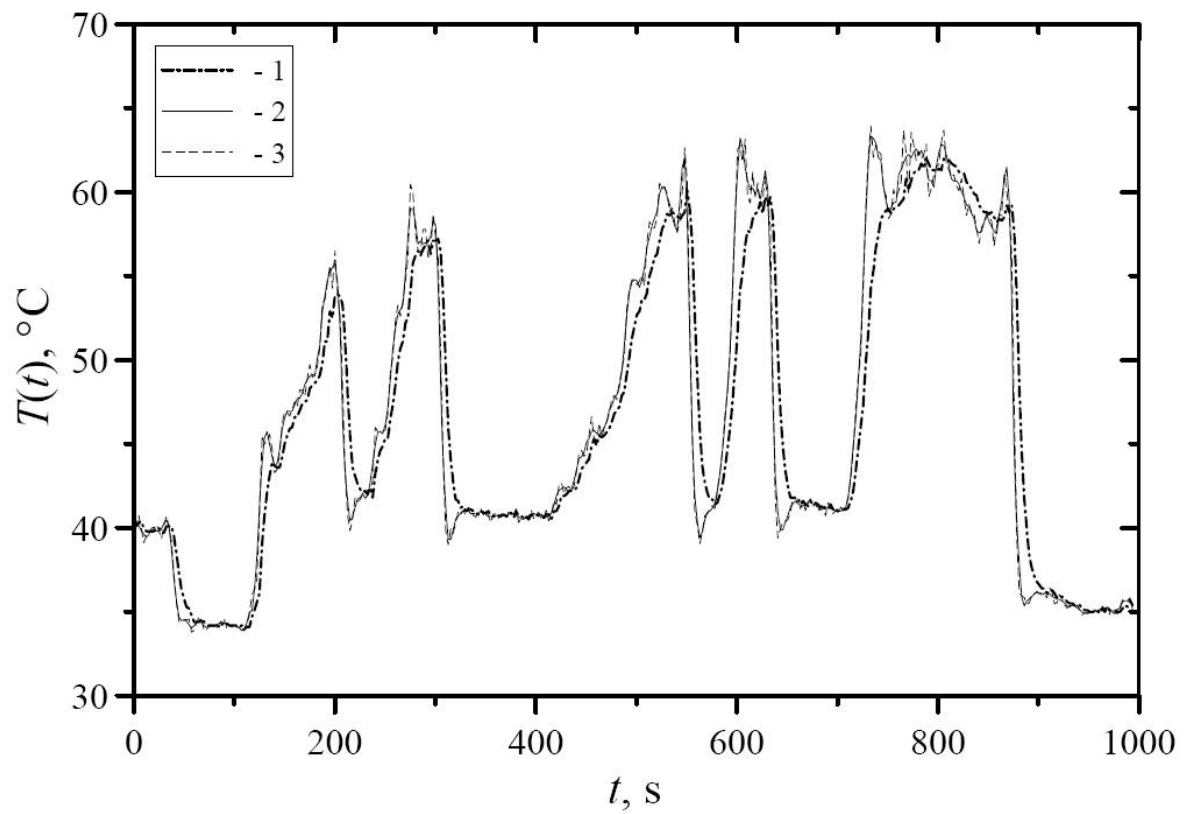

Fig. 8. Thermocouple and air temperatures: 1 - thermocouple temperature obtained from measurement; 2 - air temperature $T_{cz}(t)$, time derivative dT/dt in Eq. (1) approximated using nine-point moving average filter; 3 - air temperature $T_{cz}(t)$, time derivative dT/dt in Eq. (1) approximated by central difference quotient

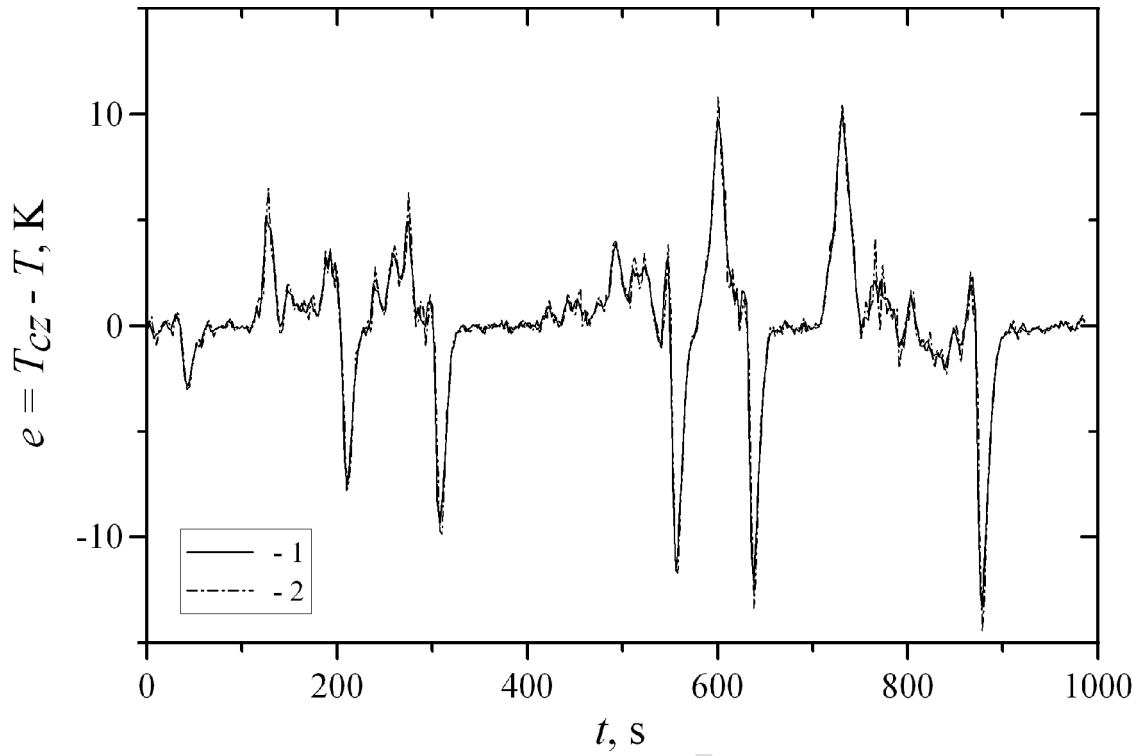

Fig. 9. Temperature difference $e = T_{cz} - T$ between air temperature T_{cz} and temperature T indicated by thermocouple: 1 – time derivative dT/dt in Eq. (1) approximated using nine-point moving average filter; 2 - time derivative dT/dt in Eq. (1) approximated by central difference quotient