



HAL
open science

Hilbert Transform-Based Bearing Failure Detection in DFIG-Based Wind Turbines

Yassine Amirat, Vincent V. Choqueuse, Mohamed Benbouzid, Sylvie Turri

► **To cite this version:**

Yassine Amirat, Vincent V. Choqueuse, Mohamed Benbouzid, Sylvie Turri. Hilbert Transform-Based Bearing Failure Detection in DFIG-Based Wind Turbines. *International Review of Electrical Engineering*, 2011, 6 (3), pp.1249-1256. hal-00630431

HAL Id: hal-00630431

<https://hal.science/hal-00630431>

Submitted on 10 Oct 2011

HAL is a multi-disciplinary open access archive for the deposit and dissemination of scientific research documents, whether they are published or not. The documents may come from teaching and research institutions in France or abroad, or from public or private research centers.

L'archive ouverte pluridisciplinaire **HAL**, est destinée au dépôt et à la diffusion de documents scientifiques de niveau recherche, publiés ou non, émanant des établissements d'enseignement et de recherche français ou étrangers, des laboratoires publics ou privés.

Hilbert Transform-Based Bearing Failure Detection in DFIG-Based Wind Turbines

Yassine Amirat^{1,2}, Vincent Choqueuse¹, Mohamed Benbouzid¹ and Sylvie Turri¹

Abstract—Cost-effective, predictive and proactive maintenance of wind turbines assumes more importance with the increasing number of installed wind farms in more remote location (offshore). A well-known method for assessing impending problems is to use current sensors installed within the wind turbine generator. This paper describes then an approach based on the generator stator current data collection and attempts to highlight the use of the Hilbert transform for failure detection in a doubly-fed induction generator-based. Indeed, this generator is commonly used in modern variable-speed wind turbines. The proposed failure detection technique has been validated experimentally regarding bearing failures. Indeed, a large fraction of wind turbine downtime is due to bearing failures, particularly in the generator and gearbox. **Copyright © 2011 Praise Worthy Prize S.r.l. - All rights reserved.**

Keywords: Wind turbine, doubly-fed induction generator, fault detection, amplitude modulation, Hilbert transform.

Nomenclature

WT	=	Wind Turbine;
DFIG	=	Doubly-Fed Induction Generator;
HT	=	Hilbert Transform;
DHT	=	Discrete Hilbert Transform;
FFT	=	Fast Fourier Transform;
IFFT	=	Inverse FFT;
AM	=	Amplitude Modulation;
i	=	Current;
n	=	Sample index ($n = 0, \dots, N - 1$);
N	=	Number of received samples;
ϕ	=	Phase parameter;
F_e	=	Sampling frequency.

I. Introduction

Recent experience has shown that despite the benefit of successful integration of a large proportion of wind energy into the domestic supply, and a continuous expansion of the wind turbine industry, the profitability of wind farms is increasingly affected by poor system reliability, and hence, high maintenance costs [1]. Moreover, the effect of low reliability on turbine downtime has become more acute for offshore wind farms. With the development these wind farms due to increasing land constraints, new challenges arise particularly with regard to maintenance. Indeed, maintenance is significantly restricted during periods of high wind speed and significant wave height. In this context, cost-effective, predictive and proactive maintenance of wind turbines assumes more importance

(Fig. 1) [2-4]. Wind turbine condition monitoring systems provide then an early indication of component incipient failure, allowing the operator to plan system repair prior to complete failure.

A quantitative analysis of real wind turbine failure data has shown important features of failure rate values and trends. A failures number distribution check-off is reported in Figs. 2 and 3 for Swedish, Danish and German wind power plants that occurred between 1994 and 2004 [4-5]. These figures show that approximately 45% of failures were linked to the electrical system, sensors and blades/pitch components. The experience feedback of wind turbine industries states that the major concern is on the electrical system. Typical failures include: dynamic air gap irregularities, generator bearing failure, stator and rotor winding; insulation failures, inter-turn short circuits in stator windings, broken rotor bar or cracked rotor end-rings and harmonic derating.

Many techniques and tools are available for the condition monitoring of wind turbines in order to extend their life span. Some of the technology used for monitoring includes pre-installed sensors, which may measure speed, output torque, vibrations, temperature, flux densities, etc.

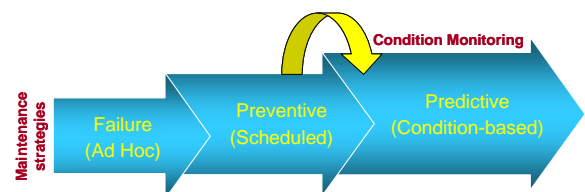

Fig. 1. The shift to condition-based maintenance monitoring.

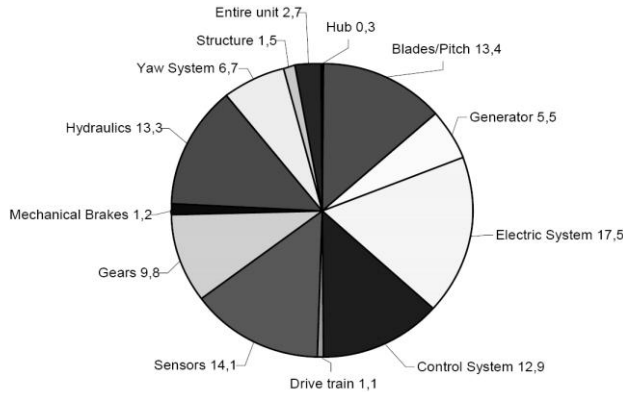

Fig. 1. Failure number distribution for Swedish wind power plants (2000-2004) [5].

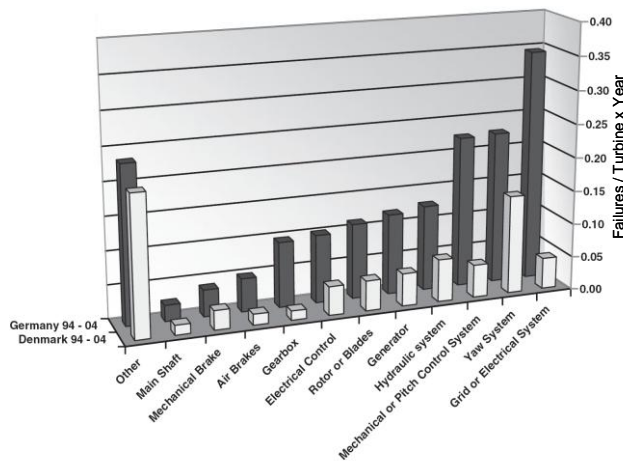

Fig. 3. Failure rates for Danish and German wind power plants [5].

These sensors are managed together in different architectures and coupled with algorithms to allow an efficient monitoring of the system condition. Those methods are inspired from electric motor condition monitoring [6]. From the theoretical and experimental point of view, the well-established methods are: electrical quantities signature analysis (current, power...), vibration monitoring, temperature monitoring and oil monitoring. In the case of DFIG-based wind turbines, it has been shown that failure in the drive train could be diagnosed from the electrical quantities of the generator [7-8]. This principle has been used to diagnose unbalance and failure in the blades of a small wind turbine by measuring the power spectrum density at the turbine generator terminal [9]. The advantage of signature analysis of the generator electrical quantities is that those quantities are easily extractible during operation i.e. the current can be

acquired by current transformer, the voltage via a voltage transformer and the power by computation. Moreover, current and voltage transducers are usually cheaper than vibration and torque transducers. Analysis of the generator electrical quantities usually involves the use of signal processing techniques.

For steady state operations, the FFT is the most popular algorithm. However, in the case of variable speed DFIG-based wind turbines, FFT is difficult to interpret since the operation is predominately nonstationary due to the stochastic behavior of the wind speed. To overcome this problem, electric machine conditions monitoring and failure diagnosis procedures based on time-frequency representations (Spectrogram, Quadratic TFR, etc...) or time-scale analysis (wavelet) have been proposed in the literature of the electric machines community [10-15]. Nevertheless, these techniques have drawbacks such as high complexity, poor resolution and/or may suffer from artifacts (cross-terms, etc.).

This paper presents a less complex failure detector for DFIG-based wind turbines which is appropriate for nonstationary operations and transient behavior [16-18]. It focuses on mechanical failures that lead to stator current amplitude modulation. These include, for example, air gap eccentricity, bearing wear and failure [19]. The proposed failure detection technique will be experimentally tested in case of bearing failures. Indeed, a large fraction of wind turbine downtime is due to bearing failures, particularly in the generator and gearbox [4].

II. Design of the Hilbert Transform-Based Failure Detector

The Hilbert transform-based failure detector principle is illustrated by Fig. 4.

II.1. Generator Current

An amplitude-modulated stator current can be expressed by

$$i(n) = a(n) \cos(2\pi n f / F_e + \phi) \quad (1)$$

The amplitude $a(n)$ in (1) depends on the failure hypothesis: for a healthy generator, $a(n)$ is constant, and for faulty generator, it varies with time (AM) [19].

For failure detection, a two-step approach can be used: first, an amplitude demodulation technique is used to estimate $a(n)$; then, a statistical test is performed to track its time-variation.

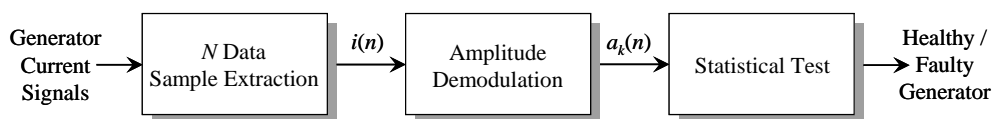

Fig. 4. HT-Based failure detector principle.

II.2. Amplitude Demodulation

Popular amplitude demodulation techniques include Hilbert transform [20] and Teager energy operator [21]. Furthermore for three-phase system, it has been recently shown that the Concordia transform can be employed to perform demodulation [22]. In this study, one phase current is considered. In this context, the Hilbert transform is chosen to estimate the envelope $a(n)$ since it is usually more robust against noise than the Teager energy operator.

Let us consider a discrete sequence $i(n)$. The discrete Hilbert transform of $i(n)$ is given by

$$\mathcal{H}[i(n)] = \mathcal{F}^{-1} \{ \mathcal{F} \{ i(n) \} \cdot u(n) \} \quad (2)$$

where $\mathcal{F}\{\cdot\}$ and $\mathcal{F}^{-1}\{\cdot\}$ correspond to the FFT and IFFT, respectively, and where $u(n)$ is defined as

$$u(n) = \begin{cases} 1, & n = 0, \frac{N}{2} \\ -j, & n = 1, 2, \dots, \frac{N}{2} - 1 \\ j, & n = \frac{N}{2} - 1, \dots, N - 1 \end{cases} \quad (3)$$

Using (1), the estimated envelope, denoted $\hat{a}(n)$, is given by

$$\hat{a}(n) = \sqrt{i^2(n) + (\mathcal{H}[i(n)])^2} \quad (4)$$

II.3. Statistical Test for Failure Detection

Once the envelope $\hat{a}(n)$ has been estimated, a statistical test is performed to detect if $\hat{a}(n)$ is constant or varies with time. For that purpose, let us compute the variance σ^2 of the estimated envelope with the following equation

$$\sigma^2 = \frac{1}{N} \sum_{n=0}^{N-1} (\hat{a}(n) - \mu)^2 \quad (5)$$

where μ is $\hat{a}(n)$ mean which is defined by

$$\mu = \frac{1}{N} \sum_{n=0}^{N-1} \hat{a}(n) \quad (6)$$

As $\hat{a}(n)$ is theoretically constant for healthy generator, it follows that $\mu = \hat{a}(n)$ and then $\sigma^2 = 0$. For faulty generator, the envelope $\hat{a}(n)$ is time-varying which implies that $\mu \neq \hat{a}(n)$ and then $\sigma^2 > 0$. These two properties lead us to propose a simple hypothesis test for failure detection based on σ^2 :

- If $\sigma^2 < \gamma$, the generator is stated healthy.
- If $\sigma^2 > \gamma$, the generator is stated faulty.

where γ is a threshold which can be set subjectively depending on a false alarm probability.

III. Hilbert Transform-Based Failure Detector Tests

III.1. Test Facility Description

As mentioned in a number of previously published paper, one of the main difficulties in real word testing of developed condition monitoring technique, is the lack of collaboration needed with WT operators and manufacturers, due to data confidentiality, particularly when failures are present [2].

Therefore, the proposed HT-based failure detector has been experimentally tested on setup shown in Fig. 5. Indeed, this Fig. 5 describes the experimental setup which has been operated in a motor configuration for experimental easiness. It is composed of two parts: a mechanical part that has a tachogenerator, a three-phase induction motor and an alternator. The tachogenerator is a DC machine that generates 90 V at 3000 rpm. It is used to measure the speed. It produces linear voltage between 2500 and 3000 rpm. The alternator is a three-phase synchronous machine with a regulator and a rectifier circuit that stabilize the output voltage at 12 VDC. The advantage of using a car alternator instead of DC generator is obtaining constant output voltage at various speeds. The induction motor could be identically loaded at different speeds.

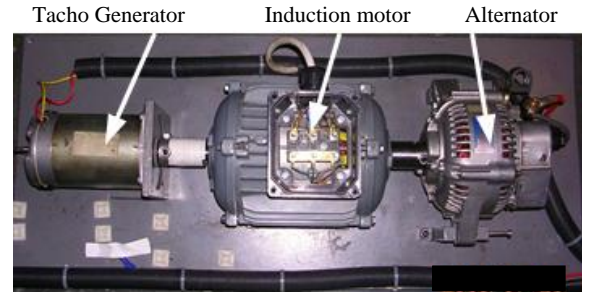

(a) Mechanical part.

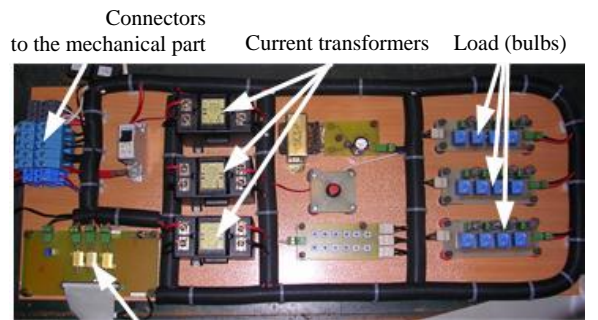

(b) Electrical part.

Fig. 5. Experimental setup.

Moreover, if the induction motor is supplied from the network, motor current will have time and space harmonic components as well as bearing fault sourced harmonics. This makes it harder to determine the bearing failure effect on the stator current and therefore complicates the fault detection process. For these reasons, the induction is fed by an alternator. By this way, supply harmonics effects are eliminated and only bearing failure effects could be observed on the stator current. Figure 6 is then given to illustrate the experimental test philosophy.

The tested induction motor has the following rated parameters: 0.75 kW, 220/380 V, 1.95/3.4 A, 2780 rpm, 50 Hz, 2 poles, Y-connected. It has two 6204.2ZR type bearings. From the bearing data sheet the following parameters are obtained: The outside diameter is 47 mm and inside one is 20 mm. Assuming that the inner and the outer races have the same thickness gives the pitch diameter $D_p = 31.85$ mm. The bearing has eight balls ($N = 8$) with an approximate diameter of $D_B = 12$ mm and a contact angle $\theta = 0^\circ$. These bearings are made to fail by drilling holes of various radiuses with a diamond twist bit while controlling temperature by oil circulation in experiments. Some of the artificially deteriorated bearings are shown in Figure 7 [23].

III.2. Failure Detector Test

The proposed Hilbert-transform failure detector has been tested with experimental signals corresponding to bearing outer race deterioration (Fig. 7a).

Once the envelope has been estimated, 10 samples have been removed at the beginning and at the end of $\hat{a}(n)$ to avoid the edge effects problem of the Hilbert transform.

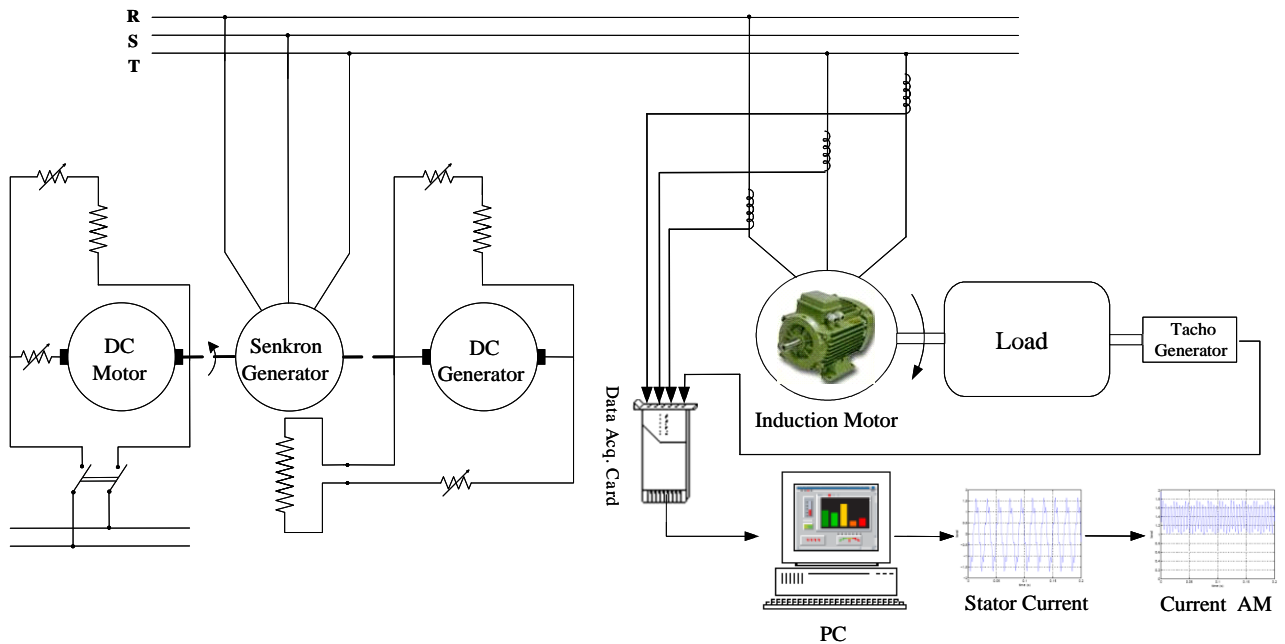

Fig. 6. Test facility.

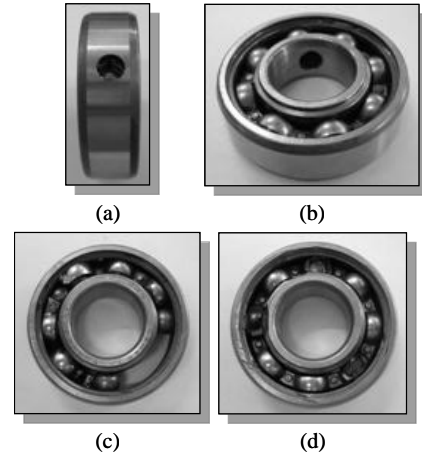

Fig. 7. Artificially deteriorated bearings: (a) outer race deterioration, (b) inner race deterioration, (c) cage deterioration, (d) ball deterioration.

Figures 8 and 9 display the stator current $i(n)$ and the envelope $\hat{a}(n)$, respectively, for a healthy generator. As the system is not perfect, one could note some small variations on the envelope $\hat{a}(n)$. In the presence of a bearing failure, the stator current and the envelope are shown in Figs. 10 and 11, respectively. Compared to the healthy case, stronger oscillations of $\hat{a}(n)$ can be observed.

Table 1 reports the value of σ^2 for the faulty and healthy generators. As previously discussed, σ^2 is not strictly equal to 0 even if the generator is healthy ($\sigma^2 = 0.012$). However when a bearing failure occurs, this criteria is multiplied by 4.333. In this condition, a failure can be detected by setting the hypothesis-test threshold to $\gamma = 0.032$ for example.

TABLE I
FAULT DETECTOR FOR HEALTHY AND FAULTY GENERATOR.

Demodulation	Healthy case	Faulty case
Hilbert Transform	$\sigma^2 = 0.012$	$\sigma^2 = 0.052$

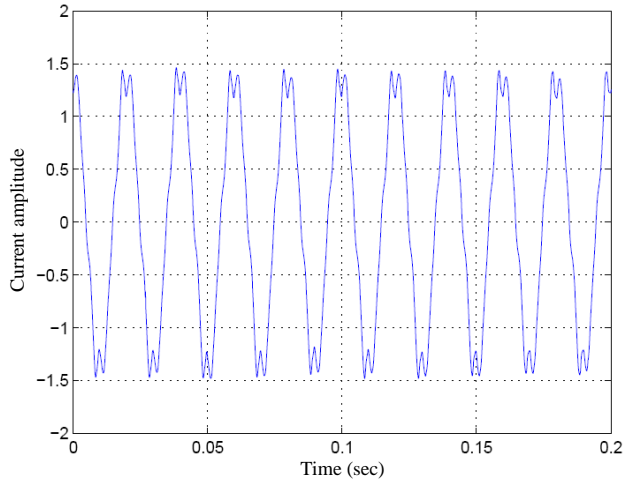

Fig. 8. Stator current $i(n)$ of a healthy generator.

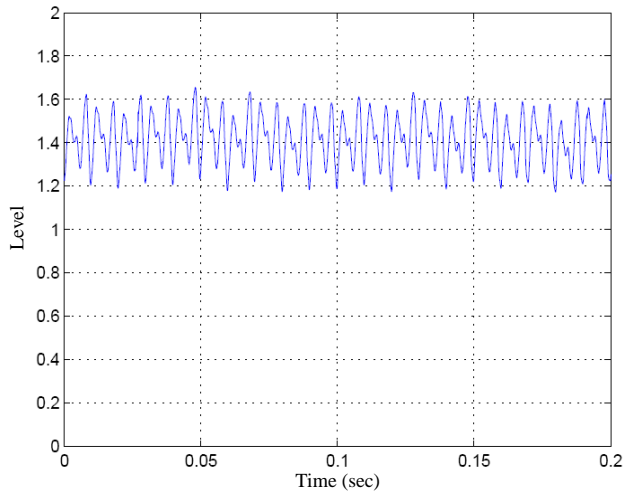

Fig. 9. Envelope $\hat{a}(n)$ of a healthy generator.

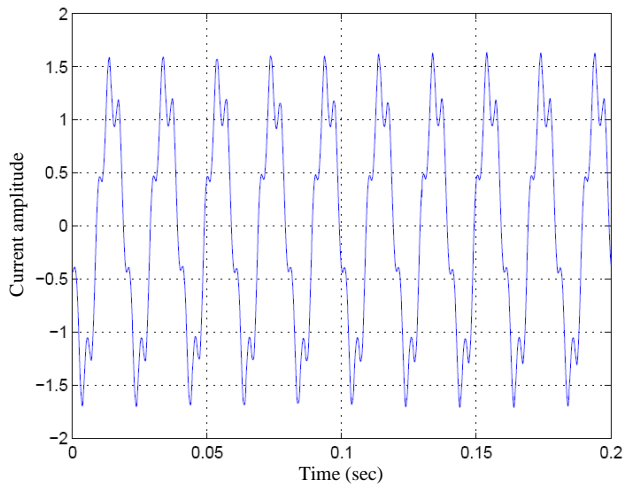

Fig. 10. Stator current $i(n)$ of a faulty generator.

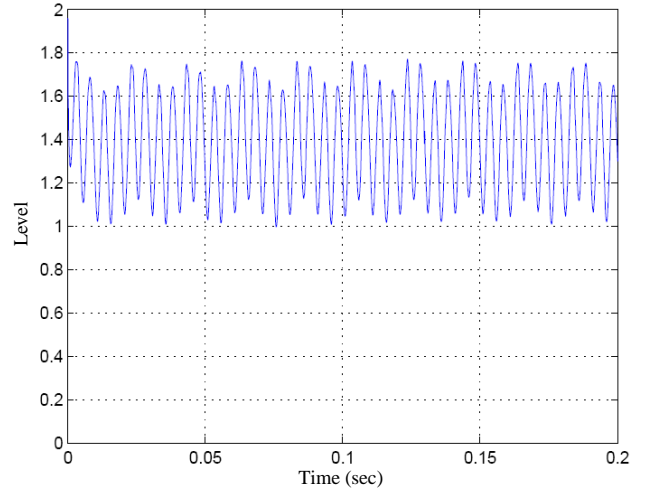

Fig. 11. Envelope $\hat{a}(n)$ of a faulty generator.

IV. Prospective Real Word Implementation

Condition Monitoring Systems (CMS) that monitor key components of wind turbines is becoming a component of long-term service packages provided by some wind turbine manufacturers (Fig. 12). Condition-based maintenance of wind turbines encompasses: Service and inspection; measuring and evaluating the actual wind turbine conditions and determining the remaining service life; and maintenance. In general, the actual condition of the rotating machinery can be measured and evaluated offline using mobile measurement equipment and online using permanently installed devices. Today it is state-of-the-art for onshore and offshore wind turbines to be equipped with vibration-based condition monitoring.

The proposed current-based condition monitoring could therefore be easily implemented on the same platform.

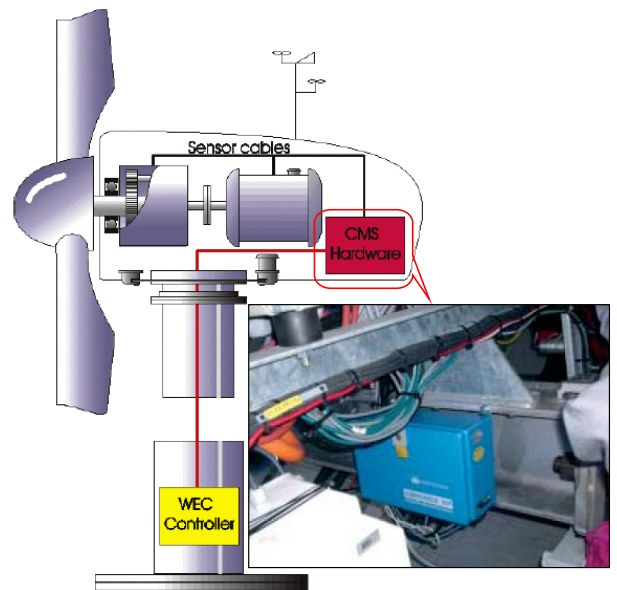

Fig. 12. CMS mounted on the main carrier of wind turbine.

The objective of this section is to propose a simple and practical approach for an industrial implementation of remote fault detection and diagnosis.

IV.1. Real Wind Turbine

Today, most turbines are fitted with equipment that makes it possible to collect condition monitoring data remotely via modem or internet. Moreover, since wind turbines are typically built in onshore or offshore wind farm configurations; there is a need for building up networks. The proposed architecture is based on an industrial Embedded PC (EPC) which is dedicated to collect data from the DFIG-based wind turbines via the extended I/O modules and transfers the data to users through LAN network. The EPC is configured to transmit data in asynchronous mode such that all the data are stored (buffered) in specific data blocs and no data are lost during the processing. This allows investigation of data for further purposes. The EPC has also the task for managing alarm and emergency shut down procedure.

Figure 13 depicts the data collection approach for a real wind turbine via an industrial data bus. In this case, it is proposed to use the Microbox PC 420 [24]. Indeed, it is the system heart and it provides great flexibility by integrating:

- A real time kernel (WinAC RTX) that allows the wind turbine control process management and execution through an industrial field bus.
- A pre-installed operating system (embedded Windows XP).

The data acquisition, supervision, and control tasks are managed by an embedded PC, while the failure detection and diagnosis task is supervised by another PC on which

arte implemented the signal processing-based failure detection techniques.

It should be noted, that the proposed Microbox PC 420 could be easily mounted within or near the CMS.

IV.2. Wind Farm Case

With advances in microprocessor memory and computing power, communication platforms, open protocol architectures, and Internet browsing capabilities, SCADA (Supervisory Control and Data Acquisition) systems keep developing to provide more flexibility to operate turbines and farms [25-27].

The wind farm SCADA server, housed within the substation control building, receives and transmits data to and from various elements of the overall wind farm system (Fig. 14) [28].

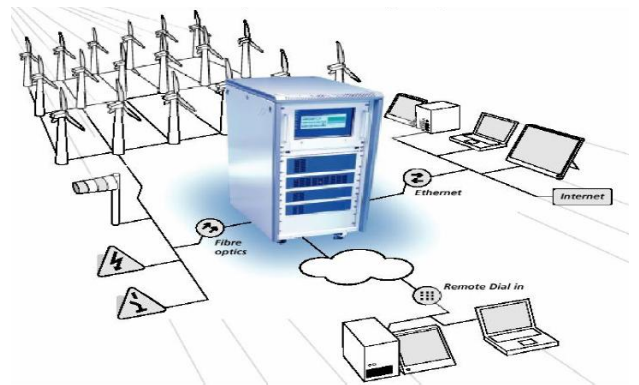

Fig. 1. Wind farm SCADA system [27].

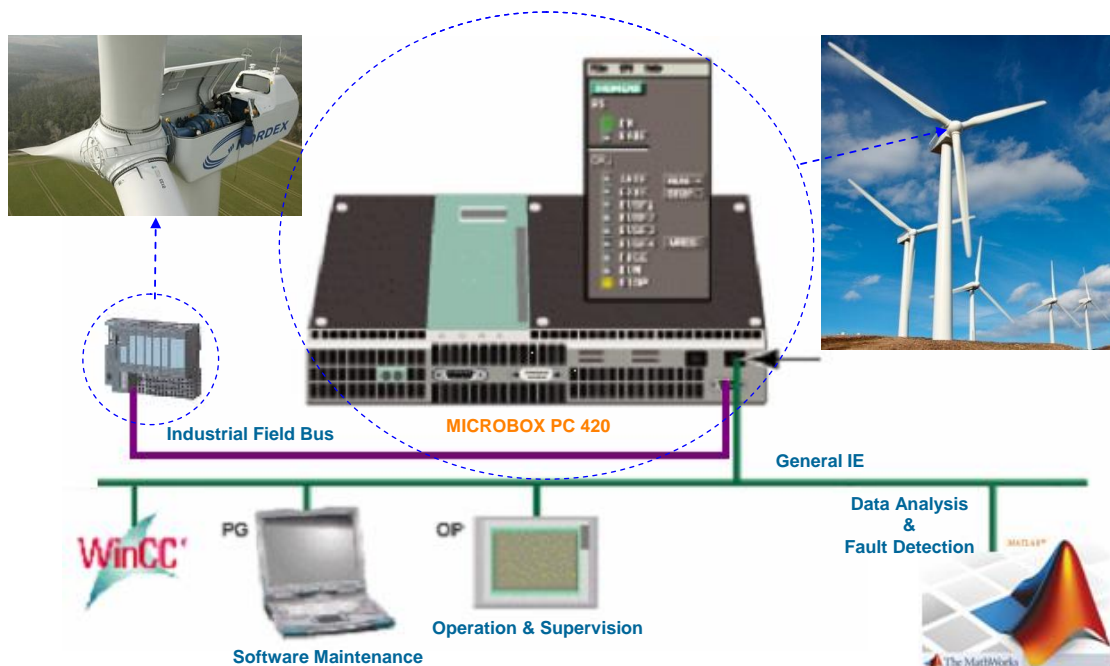

Fig. 13. Prospective real word implementation.

For the communication within a wind energy converter itself and from the wind energy converter to the outside world, an Ethernet network with TCP/IP (Transmission Control Protocol/Internet Protocol) has been proved to be most suitable. There are also other solutions possible, e.g. WLAN (Wireless Local Area Networks) from a wind energy converter to a centralized SCADA system or farm server [25], [29].

As mentioned in the previous section and as shown in the available literature [25], it is obvious that the proposed Microbox PC 420 should be a good candidate for wind turbines condition monitoring.

V. Conclusion

This paper dealt with implementation of a low-complexity signal processing technique for bearing failure detection in DFIG-based wind turbines. Using experimental data, it was found that the proposed technique gives a significant criterion for failure detection.

This paper also dealt with a prospective implementation in real world. It has therefore been proposed the use of the Microbox PC 420 that could be easily mounted within or near the CMS. Regarding the available literature, the proposal could be an interesting practical approach for wind turbines condition monitoring.

References

- [1] C.S. Gray and S.J. Watson, "Physics of failure approach to wind turbine condition based maintenance," *Wind Energy*, vol. 13, n°5, pp. 395-405, July 2010.
- [2] W. Yang, P.J. Tavner, C.J. Crabtree and M. Wilkinson, "Cost-effective condition monitoring for wind turbines," *IEEE Trans. Industrial Electronics*, vol. 57, n°1, pp. 263-271, January 2010.
- [3] F. Besnard and L. Bertling, "An approach for condition-based maintenance optimization applied to wind turbine blades," *IEEE Trans. Sustainable Energy*, vol. 1, n°2, pp. 77-83, July 2010.
- [4] S.J. Watson, B.J. Xiang, W. Yang, P.J. Tavner and C.J. Crabtree, "Condition monitoring of the power output of wind turbine generators using wavelets," *IEEE Trans. Energy Conversion*, vol. 25, n°3, pp. 715-721, September 2010.
- [5] Y. Amirat, M. Benbouzid and E. Al-Ahmar, "A brief status on condition monitoring and fault diagnosis in wind energy conversion systems," *Renewable & Sustainable Energy Reviews*, vol. 3, n°9, pp. 2629-2636, December 2009.
- [6] M.E.H. Benbouzid, "A review of induction motors signature analysis as a medium for faults detection," *IEEE Trans. Industrial Electronics*, vol. 47, n°5, pp. 984-993, October 2000.
- [7] E. Al-Ahmar, V. Choqueuse, M.E.H. Benbouzid and Y. Amirat, "Advanced signal processing techniques for fault detection and diagnosis of a wind turbine induction generator drive train: A comparative study," in *Proceedings of the IEEE ECCE'10*, Atlanta (USA), pp. 3576-3581, September 2010.
- [8] E. Al-Ahmar, M.E.H. Benbouzid and S. Turri, "Wind energy conversion systems fault diagnosis using wavelet analysis," *International Review of Electrical Engineering*, vol. 3, n°4, pp. 646-652, July-August 2008.
- [9] W.Q. Jeffries, J.A. Chambers, and D.G. Infield, "Experience with bicoherence of electrical power for condition monitoring of wind turbine blades," *IEE Proc Vision, Image & Signal Processing*, vol. 145, n°3, pp. 141-148, June 1998.
- [10] E.C.C. Lau and H.W. Ngan, "Detection of motor bearing outer raceway defect by wavelet packet transformed motor current signature analysis," *IEEE Trans. Instrumentation & Measurement*, vol. 59, n°10, pp. 2683-2690, October 2010.
- [11] K. Teotrakool, M.J. Devaney and L. Eren, "Adjustable-speed drive bearing-fault detection via wavelet packet decomposition," *IEEE Trans. Instrumentation & Measurement*, vol. 58, n°8, pp. 2747-2754, August 2009.
- [12] J. Liu, W. Wang and F. Golnaraghi, "An extended wavelet spectrum for bearing fault diagnostics," *IEEE Trans. Instrumentation & Measurement*, vol. 57, n°12, pp. 2801-2812, December 2008.
- [13] S. Rajagopalan, J. A. Restrepo, J. Aller, T. Habetler, and R. Harley, "Non stationary motor fault detection using recent quadratic time frequency representations," *IEEE Trans. Industry Applications*, vol. 44, n°3, pp. 735-744, May-June 2008.
- [14] M. Blodt, D. Bonacci, J. Regnier, M. Chabert, and J. Faucher, "Online monitoring of mechanical faults in variable-speed induction motor drives using the Wigner distribution," *IEEE Trans. Industrial Electronics*, vol. 55, n°2, pp. 522-533, February 2008.
- [15] L. Eren, Y. Çekiç, M.J. Devaney, "Broken rotor bar detection via wavelet packet decomposition of motor current," *International Review of Electrical Engineering*, vol. 4, n°5, pp. 844-850, October 2009.
- [16] N.Q. Hu, L.R. Xia, F.S. Gu and G.J. Qin, "A novel transform demodulation algorithm for motor incipient fault detection," *IEEE Trans. Instrumentation & Measurement*, vol. 60, n°2, pp. 480-487, February 2008.
- [17] Y. Amirat, V. Choqueuse and M.E.H. Benbouzid, "Wind turbines condition monitoring and fault diagnosis using generator current amplitude demodulation," in *Proceedings of the IEEE ENERGYCON'10*, Manama (Bahrain), pp. 310-315, December 2010.
- [18] Y. Amirat, V. Choqueuse and M.E.H. Benbouzid, "Condition monitoring of wind turbines based on amplitude demodulation," in *Proceedings of the IEEE ECCE'10*, Atlanta (USA), pp. 2417-2421, September 2010.
- [19] M. Blodt, J. Regnier, and J. Faucher, "Distinguishing load torque oscillations and eccentricity faults in induction motors using stator current Wigner distributions," *IEEE Trans. Industry Applications*, vol. 45, n°6, pp. 1991-2000, November-December 2009.
- [20] A. Oppenheim, R. Schaffer and W. Padgett. *Discrete-Time Signal Processing*, Prentice Hall, 2009.
- [21] P. Maragos, J. Kaiser, and T. Quatieri, "On amplitude and frequency demodulation using energy operators," *IEEE Trans. Signal Processing*, vol. 41, n°4, pp. 1532-1550, April 1993.
- [22] B. Trajin, M. Chabert, J. Regnier, and J. Faucher, "Hilbert versus Concordia transform for three phase machine stator current time-frequency monitoring," *Mechanical Systems & Signal Processing*, vol. 23, n°8, pp. 2648-2657, November 2009.
- [23] I.Y. Önel and M.E.H. Benbouzid, "Induction motor bearing failures detection and diagnosis using a RBF ANN Park pattern based method," *International Review of Electrical Engineering*, vol. 3, n°1, pp. 159-165, January-February 2008.
- [24] <http://www.automation.siemens.com/>
- [25] Z. Hameed, S.H. Ahn and Y.M. Cho, "Practical aspects of a condition monitoring system for a wind turbine with emphasis on its design, system architecture, testing and installation," *Renewable Energy*, Vol. 35, n° 5, pp. 879-894, May 2010.
- [26] A. Kusiak and W. Li, "The prediction and diagnosis of wind turbine faults," *Renewable Energy*, Vol. 36, n°1, pp. 16-23, January 2011.
- [27] Z. Lubosny and J.W. Bialek, "Supervisory control of a wind farm," *IEEE Trans. Power Systems*, vol. 22, n°3, pp. 985-994, August 2007.
- [28] S.W. Saylor, "Wind parks as power plants," in *Proceedings of the IEEE PESGM'06*, Montreal (Canada), pp. 1-9, June 2006.
- [29] IEC 61400-61425, Communications for Monitoring and Control of Wind Power Plants, Draft 2006.

¹University of Brest, EA 4325 LBMS, Rue de Kergoat, CS 93837, 29238 Brest Cedex 03, France (e-mail: Yassine.Amirat@univ-brest.fr, Mohamed.Benbouzid@univ-brest.fr, Vincent.Choqueuse@univ-brest.fr, Sylvie.Turri@univ-brest.fr).

²ISEN-Brest, 20, Rue Cuirassé Bretagne, CS 42807, 29228 Brest Cedex 2, France.



Yassine Amirat was born in Annaba, Algeria, in 1970. He received the B.Sc. and M.Sc. degrees both in Electrical Engineering, from the University of Annaba, Algeria, in 1994 and 1997 respectively. He is currently working toward the Ph.D. degree on wind turbines condition monitoring at the University of Brest, Brest, France.

Mr. Amirat is currently a Lecturer at the Institut Supérieur de l'Électronique et du Numérique (ISEN), Brest, France. His current research interests are the condition monitoring and the control of electrical drives and power electronics.



Vincent Choqueuse was born in Brest, France, in 1981. He received the Dipl.-Ing. and the M.Sc. degrees in 2004 and 2005, respectively, from Troyes University of Technology, Troyes, France, and the Ph.D. degree in 2008 from the University of Brest, Brest, France.

Since September 2009, he has been an Associate Professor with the Institut Universitaire de Technologie of Brest, University of Brest, Brest, France, and a member of the LBMS Lab (EA 4325). His research interests focus on signal processing and statistics for diagnosis and MIMO systems.



Mohamed El Hachemi Benbouzid was born in Batna, Algeria, in 1968. He received the B.Sc. degree in electrical engineering from the University of Batna, Batna, Algeria, in 1990, the M.Sc. and Ph.D. degrees in electrical and computer engineering from the National Polytechnic Institute of Grenoble, Grenoble, France, in 1991 and 1994, respectively, and the Habilitation à Diriger des Recherches degree from the University of Picardie "Jules Verne," Amiens, France, in 2000.

After receiving the Ph.D. degree, he joined the Professional Institute of Amiens, University of Picardie "Jules Verne," where he was an Associate Professor of electrical and computer engineering. Since September 2004, he has been with the Institut Universitaire de Technologie of Brest, University of Brest, Brest, France, where he is a Professor of electrical engineering. His main research interests and experience include analysis, design, and control of electric machines, variable-speed drives for traction, propulsion, and renewable energy applications, and fault diagnosis of electric machines.

Prof. Benbouzid is a Senior Member of the IEEE Power Engineering, Industrial Electronics, Industry Applications, Power Electronics, and Vehicular Technology Societies. He is an Associate Editor of the IEEE TRANSACTIONS ON ENERGY CONVERSION, the IEEE TRANSACTIONS ON INDUSTRIAL ELECTRONICS, the IEEE TRANSACTIONS ON VEHICULAR TECHNOLOGY, and the IEEE/ASME TRANSACTIONS ON MECHATRONICS.



Sylvie Turri was born in France, in 1972. She received the M.Sc. degree in electrical engineering from the University of Nancy, Nancy, France, in 1996. She was awarded the Ph.D. degree in electrical engineering from the University of Franche-Comté, Belfort, France in 2000.

After receiving the Ph.D. degree, she joined the Ecole Nationale Supérieure of Cachan and the SATIE Lab (UMR CNRS 8029) at Rennes, France, as a Teaching and Research Associate. In 2004, she joined the Institut Universitaire de Technologie of Aix-Marseille, University of Marseille III, Marseille, France, as an Associate Professor of electrical engineering. She was appointed to the LSIS Lab (UMR CNRS 6168). In 2006, she joined the Institut Universitaire de Technologie of Brest, University of Brest, Brest, France, as an Associate Professor of electrical engineering, and a member of the LBMS Lab (EA 4325). Her main research interests are in the field of electromechanical systems (power generation, fault diagnosis).