

Optimal Control of a Multi-Energy District Boiler: a Case Study

Julien Eynard¹, Stéphane Grieu² & Monique Polit³

¹Ph.D. student (2007-2010), PROMES (ELIAUS) laboratory, UPVD, France
Post-doc (2010-2011), Automatic Control Department, Supélec, France

²Assistant professor, PROMES (ELIAUS) laboratory, UPVD, France

³Professor, PROMES (ELIAUS) laboratory, UPVD, France

IFAC WC, 28 August - 2 September 2011, Milano, Italy

Outline

- 1 Energetic context
- 2 Opti-EnR project
- 3 Modeling and identification
- 4 Thermal storage tank model
- 5 Forecasting exogenous variables
- 6 Control and optimization

Outline

- 1 Energetic context
 - 2 Opti-EnR project
 - 3 Modeling and identification
 - 4 Thermal storage tank model
 - 5 Forecasting exogenous variables
 - 6 Control and optimization
- High energy potential sector

Building heating

- Building sector: the most energy-consuming in France (69 Mtoe) en 2008
- Heating: 1st energy-consuming in the building sector (70 %)
- Main energy used for building heating: gas (33 %) and oil (21 %)

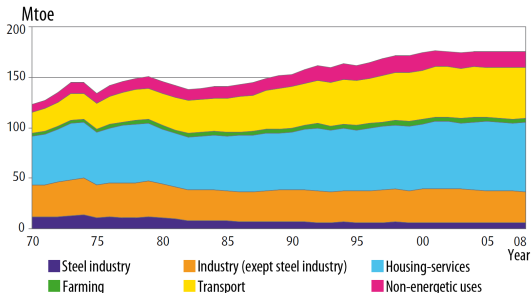

Building heating

- Building sector: the most energy-consuming in France (69 Mtoe) en 2008
- Heating: 1st energy-consuming in the building sector (70 %)
- Main energy used for building heating: gas (33 %) and oil (21 %)

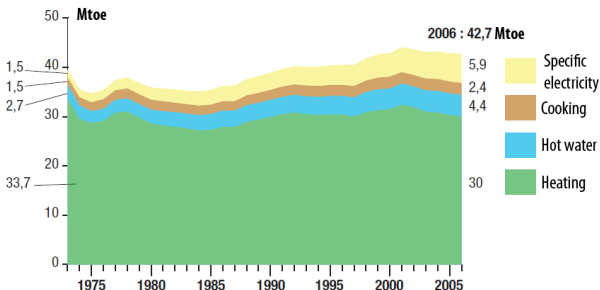

Building heating

- Building sector: the most energy-consuming in France (69 Mtoe) en 2008
- Heating: 1st energy-consuming in the building sector (70 %)
- Main energy used for building heating: gas (33 %) and oil (21 %)

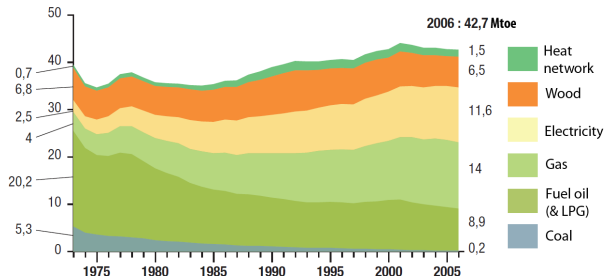

Outline

- 1 Energetic context
- 2 **Opti-EnR project**
 - District boiler of La Rochelle
 - Steps of the project
- 3 Modeling and identification
- 4 Thermal storage tank model
- 5 Forecasting exogenous variables
- 6 Control and optimization

Characteristics of the district boiler

Main elements of the plant managed by the french company Cofely GDF-SUEZ

- Wood boiler: 4,5 MW
- Gas and fuel oil boiler: 7 MW
- Cogeneration plant: 2,5 MW
- Hot water district network: 3000 m³
- Building heating: 2700 accommodations
- Domestic hot water: 800 accommodations



COFELY
GDF SUEZ

Element	Cover rate
Wood boiler	50 %
Cogeneration plant	30 à 35 %
Gas/fuel oil boiler	15 à 20 %

Synoptic of the plant

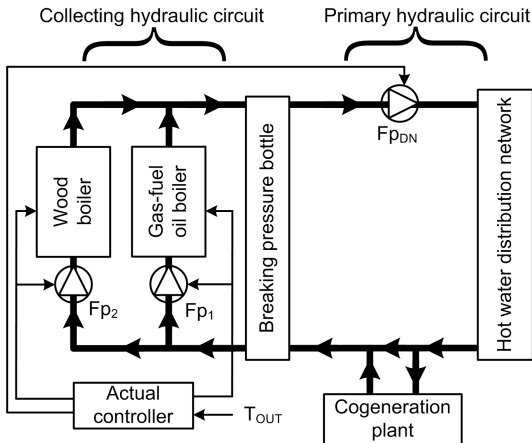

Description of the different steps

- Modeling of the plant
- Identification of parameters
- Development of a hot water storage model
- Insertion of the thermal storage model in the plant
- Short term forecasting of exogenous variables
- Development of a predictive controller

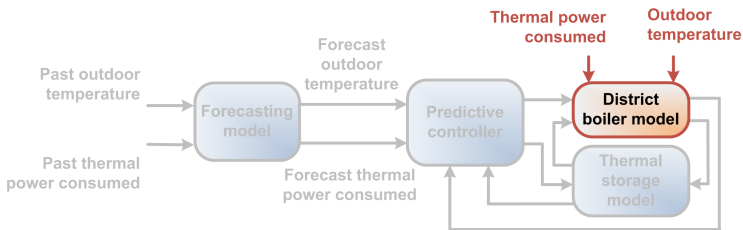

Description of the different steps

- Modeling of the plant
- Identification of parameters
- Development of a hot water storage model
- Insertion of the thermal storage model in the plant
- Short term forecasting of exogenous variables
- Development of a predictive controller

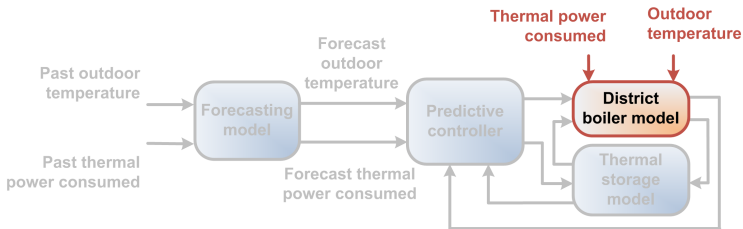

Description of the different steps

- Modeling of the plant
- Identification of parameters
- Development of a hot water storage model
- Insertion of the thermal storage model in the plant
- Short term forecasting of exogenous variables
- Development of a predictive controller

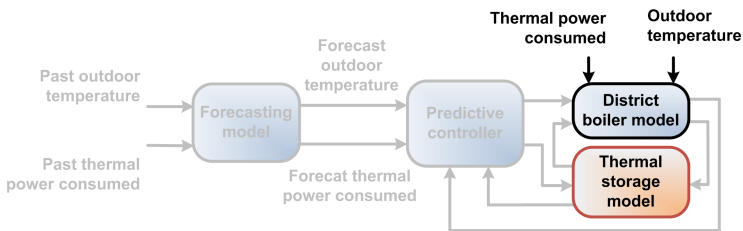

Description of the different steps

- Modeling of the plant
- Identification of parameters
- Development of a hot water storage model
- Insertion of the thermal storage model in the plant
- Short term forecasting of exogenous variables
- Development of a predictive controller

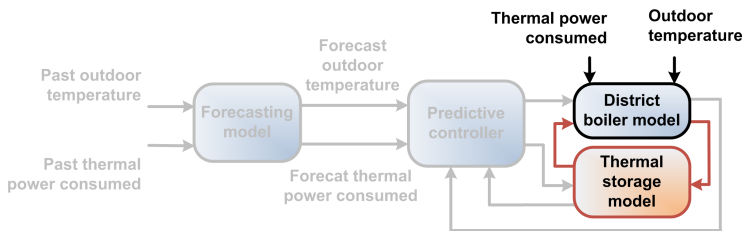

Description of the different steps

- Modeling of the plant
- Identification of parameters
- Development of a hot water storage model
- Insertion of the thermal storage model in the plant
- Short term forecasting of exogenous variables
- Development of a predictive controller

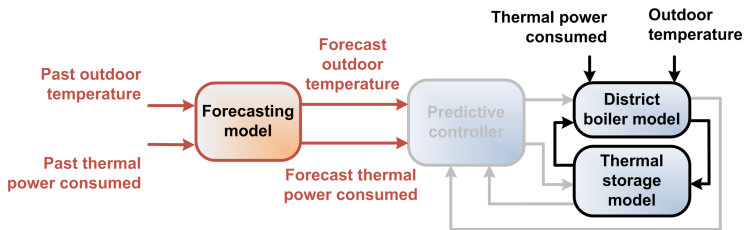

Description of the different steps

- Modeling of the plant
- Identification of parameters
- Development of a hot water storage model
- Insertion of the thermal storage model in the plant
- Short term forecasting of exogenous variables
- Development of a predictive controller

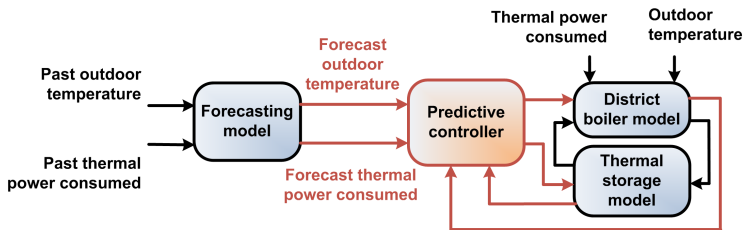

Outline

- 1 Energetic context
- 2 Opti-EnR project
- 3 Modeling and identification**
 - Procedure
 - Modeling the district boiler
- 4 Thermal storage tank model
- 5 Forecasting exogenous variables
- 6 Control and optimization

General methodology

- Modeling
 - White boxes (knowledge models)
 - Grey boxes (parametric models)
 - Black boxes (Hammerstein-Wiener models)
 - ⇒ About 50 physical variables grouped in 7 models (boilers, hydraulic network. . .)
- Iterative identification using experimental data
 - Sampling time: 5 minutes
 - Nonlinear least squares with trust-region reflective Newton method
- Comparison of modeled and experimental signals
 - Computing FIT, MRE and MAE

General methodology

- Modeling
 - White boxes (knowledge models)
 - Grey boxes (parametric models)
 - Black boxes (Hammerstein-Wiener models)
 - ⇒ About 50 physical variables grouped in 7 models (boilers, hydraulic network. . .)
- Iterative identification using experimental data
 - Sampling time: 5 minutes
 - Nonlinear least squares with trust-region reflective Newton method
- Comparison of modeled and experimental signals
 - Computing FIT, MRE and MAE

General methodology

- Modeling
 - White boxes (knowledge models)
 - Grey boxes (parametric models)
 - Black boxes (Hammerstein-Wiener models)
 - ⇒ About 50 physical variables grouped in 7 models (boilers, hydraulic network. . .)
- Iterative identification using experimental data
 - Sampling time: 5 minutes
 - Nonlinear least squares with trust-region reflective Newton method
- Comparison of modeled and experimental signals
 - Computing FIT, MRE and MAE

General methodology

- Modeling
 - White boxes (knowledge models)
 - Grey boxes (parametric models)
 - Black boxes (Hammerstein-Wiener models)
 - \Rightarrow About 50 physical variables grouped in 7 models (boilers, hydraulic network. . .)
- Iterative identification using experimental data
 - Sampling time: 5 minutes
 - Nonlinear least squares with trust-region reflective Newton method
- Comparison of modeled and experimental signals
 - Computing FIT, MRE and MAE

Overall district boiler model¹

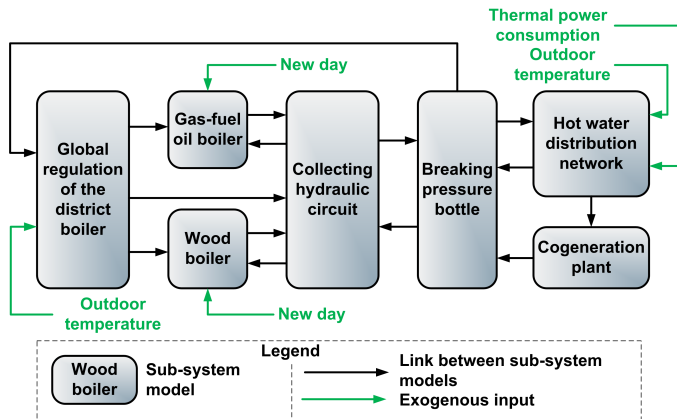

¹J. Eynard, S. Grieu & M. Polit (2011) Modular approach for modelling a multi-energy district boiler. Applied Mathematical Modelling. 35(8), August, 3926–3957

Outline

- 1 Energetic context
 - 2 Opti-EnR project
 - 3 Modeling and identification
 - 4 Thermal storage tank model**
 - 5 Forecasting exogenous variables
 - 6 Control and optimization
- Hypothesis
 - Modeling of the storage tank
 - Integration of the storage tank in the plant

Hot-water tank characteristics

- **Stored energy: 80 MWh**
- Capacity: $V_{tot} = 2000 \text{ m}^3$
- Top-down temperature gap: $35 \text{ }^\circ\text{C}$
- Vertical cylindrical shape: $V_{tot} = h \cdot \pi \cdot r^2$, $P = 2 \cdot \pi \cdot r$
- Minimization of the external surface:

$$\min_r (S_{tot}) = \min_r \left(\frac{2 \cdot V_{tot}}{r} + 2 \cdot \pi \cdot r^2 \right) \Rightarrow r = 6,8 \text{ m}, h = 13,7 \text{ m}$$
- Subsoil position: ($T_{amb} \approx 10 \text{ }^\circ\text{C}$)
- Polypropylène insulation: 10 cm

Hot-water tank characteristics

- Stored energy: 80 MWh
- Capacity: $V_{tot} = 2000 \text{ m}^3$
- Top-down temperature gap: 35 °C
- Vertical cylindrical shape: $V_{tot} = h \cdot \pi \cdot r^2$, $P = 2 \cdot \pi \cdot r$
- Minimization of the external surface:

$$\min_r (S_{tot}) = \min_r \left(\frac{2 \cdot V_{tot}}{r} + 2 \cdot \pi \cdot r^2 \right) \Rightarrow r = 6,8 \text{ m}, h = 13,7 \text{ m}$$
- Subsoil position: ($T_{amb} \approx 10 \text{ °C}$)
- Polypropylène insulation: 10 cm

Hot-water tank characteristics

- Stored energy: 80 MWh
- Capacity: $V_{tot} = 2000 \text{ m}^3$
- Top-down temperature gap: 35 °C
- Vertical cylindrical shape: $V_{tot} = h \cdot \pi \cdot r^2$, $P = 2 \cdot \pi \cdot r$
- Minimization of the external surface:

$$\min_r (S_{tot}) = \min_r \left(\frac{2 \cdot V_{tot}}{r} + 2 \cdot \pi \cdot r^2 \right) \Rightarrow r = 6,8 \text{ m}, h = 13,7 \text{ m}$$
- Subsoil position: ($T_{amb} \approx 10 \text{ °C}$)
- Polypropylène insulation: 10 cm

Hot-water tank characteristics

- Stored energy: 80 MWh
- Capacity: $V_{tot} = 2000 \text{ m}^3$
- Top-down temperature gap: 35 °C
- Vertical cylindrical shape: $V_{tot} = h \cdot \pi \cdot r^2$, $P = 2 \cdot \pi \cdot r$
- Minimization of the external surface:

$$\min_r (S_{tot}) = \min_r \left(\frac{2 \cdot V_{tot}}{r} + 2 \cdot \pi \cdot r^2 \right) \Rightarrow r = 6,8 \text{ m}, h = 13,7 \text{ m}$$
- Subsoil position: ($T_{amb} \approx 10 \text{ °C}$)
- Polypropylène insulation: 10 cm

Hot-water tank characteristics

- Stored energy: 80 MWh
- Capacity: $V_{tot} = 2000 \text{ m}^3$
- Top-down temperature gap: $35 \text{ }^\circ\text{C}$
- Vertical cylindrical shape: $V_{tot} = h \cdot \pi \cdot r^2$, $P = 2 \cdot \pi \cdot r$
- Minimization of the external surface:

$$\min_r(S_{tot}) = \min_r\left(\frac{2 \cdot V_{tot}}{r} + 2 \cdot \pi \cdot r^2\right) \Rightarrow r = 6,8 \text{ m}, h = 13,7 \text{ m}$$
- Subsoil position: ($T_{amb} \approx 10 \text{ }^\circ\text{C}$)
- Polypropylène insulation: 10 cm

Hot-water tank characteristics

- Stored energy: 80 MWh
- Capacity: $V_{tot} = 2000 \text{ m}^3$
- Top-down temperature gap: 35 °C
- Vertical cylindrical shape: $V_{tot} = h \cdot \pi \cdot r^2$, $P = 2 \cdot \pi \cdot r$
- Minimization of the external surface:

$$\min_r (S_{tot}) = \min_r \left(\frac{2 \cdot V_{tot}}{r} + 2 \cdot \pi \cdot r^2 \right) \Rightarrow r = 6,8 \text{ m}, h = 13,7 \text{ m}$$
- Subsoil position: ($T_{amb} \approx 10 \text{ °C}$)
- Polypropylène insulation: 10 cm

Hot-water tank characteristics

- Stored energy: 80 MWh
- Capacity: $V_{tot} = 2000 \text{ m}^3$
- Top-down temperature gap: 35 °C
- Vertical cylindrical shape: $V_{tot} = h \cdot \pi \cdot r^2$, $P = 2 \cdot \pi \cdot r$
- Minimization of the external surface:

$$\min_r (S_{tot}) = \min_r \left(\frac{2 \cdot V_{tot}}{r} + 2 \cdot \pi \cdot r^2 \right) \Rightarrow r = 6,8 \text{ m}, h = 13,7 \text{ m}$$
- Subsoil position: ($T_{amb} \approx 10 \text{ °C}$)
- Polypropylène insulation: 10 cm

Model adapted from the “Turbulent Mixing-Model”¹

- Parameters

$$\left\{ \begin{array}{l} k : \text{number of layers (20), } i \in \llbracket 1, k \rrbracket \\ m : \text{influence of inlet fluid (2 layers)} \\ V = V_{tot}/k \\ \alpha_{2(i)} = [U_L \cdot P / (C_{P(i)} \cdot \rho_{(i)})] \cdot \Delta \cdot \Delta z \\ \alpha_j = V + \alpha_{2(i)} \end{array} \right.$$

- Loading thermal energy

$$\left\{ \begin{array}{l} T_{(i,n)} = \{ [V - (\Delta V/m)] \cdot T_{(i,n-1)} + (\Delta V/m) \cdot T_{in} + \alpha_{2(i)} \cdot T_{ext} \} / \alpha_{(i)}, \quad (i > k - m) \\ T_{(i,n)} = \{ [V - \Delta V] \cdot T_{(i,n-1)} + \Delta V \cdot T_{(i+1,n-1)} + \alpha_{2(i)} \cdot T_{amb} \} / \alpha_{(i)}, \quad (i \leq k - m) \end{array} \right.$$

- Unloading thermal energy

$$\left\{ \begin{array}{l} T_{(i,n)} = \{ [V - (\Delta V/m)] \cdot T_{(i,n-1)} + (\Delta V/m) \cdot T_{in} + \alpha_{2(i)} \cdot T_{ext} \} / \alpha_{(i)}, \quad (i \leq m) \\ T_{(i,n)} = \{ [V - \Delta V] \cdot T_{(i,n-1)} + \Delta V \cdot T_{(i-1,n-1)} + \alpha_{2(i)} \cdot T_{amb} \} / \alpha_{(i)}, \quad (i > m) \end{array} \right.$$

¹S. Alizadeh. An experimental and numerical study of thermal stratification in a horizontal cylindrical solar storage tank. Solar Energy. 66 (1999) 409-21.

General scheme

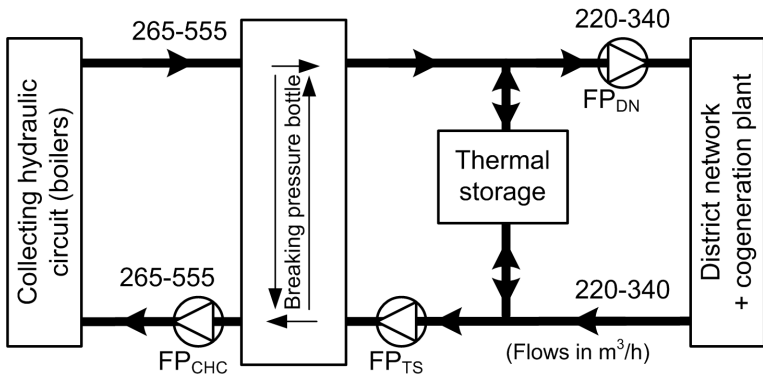

Loading energy

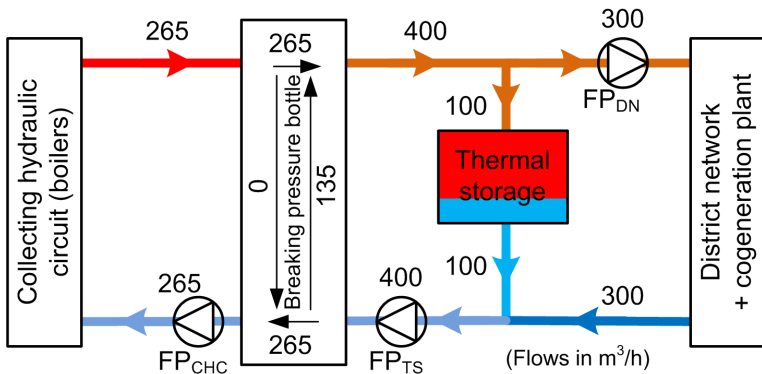

Unloading energy

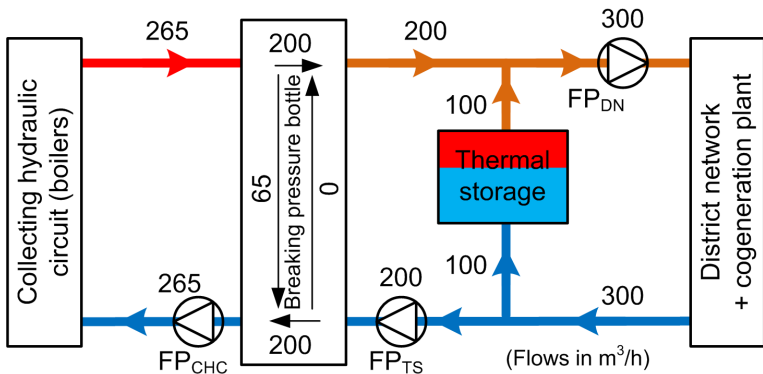

Outline

- 1 Energetic context
- 2 Opti-EnR project
- 3 Modeling and identification
 - Forecasting methodology
 - Forecasting results
- 4 Thermal storage tank model
- 5 Forecasting exogenous variables
- 6 Control and optimization

Forecasting model using time series¹

- Forecasting of outdoor temperature et heating power consumed by the district network
- Using M past sequences (4h30 long) for model inputs, completed with :
 - the day of the year,
 - the minute of the day.
 - ⇒ Interest : help the model to place himself in the time
- Model output :
 - one forecast sequence (4h30)

¹J. Eynard, S. Grieu & M. Polit (2011) Wavelet-based multi-resolution analysis and artificial neural networks for forecasting temperature and thermal power consumption. Engineering Applications of Artificial Intelligence. 24(3), April 2011, 501-516.

Forecasting model using time series¹

- Forecasting of outdoor temperature et heating power consumed by the district network
- Using M past sequences (4h30 long) for model inputs, completed with :
 - the day of the year,
 - the minute of the day.
 - ⇒ Interest : help the model to place himself in the time
- Model output :
 - one forecast sequence (4h30)

¹J. Eynard, S. Grieu & M. Polit (2011) Wavelet-based multi-resolution analysis and artificial neural networks for forecasting temperature and thermal power consumption. Engineering Applications of Artificial Intelligence. 24(3), April 2011, 501-516. 

Forecasting model using time series¹

- Forecasting of outdoor temperature et heating power consumed by the district network
- Using M past sequences (4h30 long) for model inputs, completed with :
 - the day of the year,
 - the minute of the day.
 - ⇒ Interest : help the model to place himself in the time
- Model output :
 - one forecast sequence (4h30)

¹J. Eynard, S. Grieu & M. Polit (2011) Wavelet-based multi-resolution analysis and artificial neural networks for forecasting temperature and thermal power consumption. Engineering Applications of Artificial Intelligence. 24(3), April 2011, 501-516. 

Wavelet decomposition

- Low frequency components (approximation coefficients)
 - Seasonal trends
 - daily pseudo-periodic trends
- High frequency components (detail coefficients)
 - Random weather perturbations

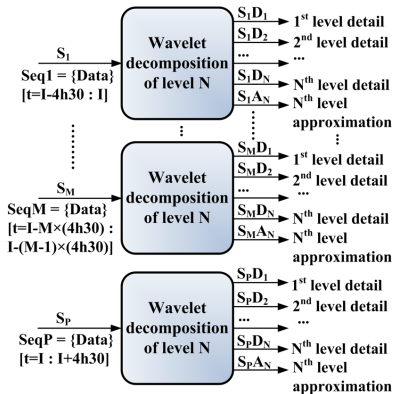

Wavelet decomposition

- Low frequency components (approximation coefficients)
 - Seasonal trends
 - daily pseudo-periodic trends
- High frequency components (detail coefficients)
 - Random weather perturbations

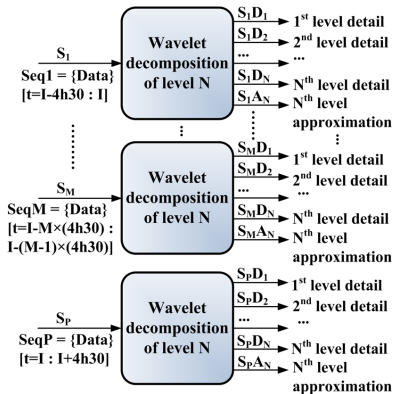

Forecasting and wavelet reconstruction

- Forecasting using multi-layer perceptrons
- Using $N+1$ MLP for a N -level wavelet decomposition
- Adding all the forecast sub-signals
- \Rightarrow One forecast sequence

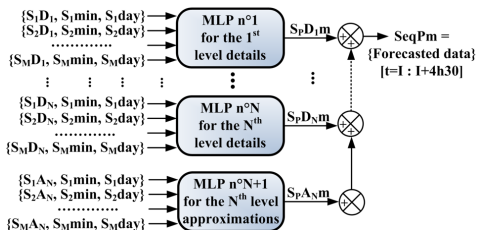

Forecasting and wavelet reconstruction

- Forecasting using multi-layer perceptrons
- Using $N+1$ MLP for a N -level wavelet decomposition
- Adding all the forecast sub-signals
- \Rightarrow One forecast sequence

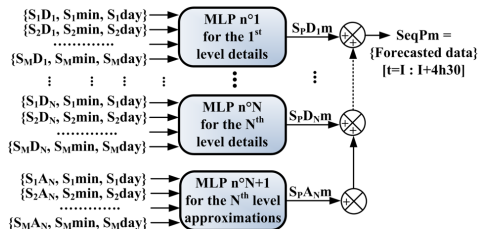

Forecasting and wavelet reconstruction

- Forecasting using multi-layer perceptrons
- Using $N+1$ MLP for a N -level wavelet decomposition
- Adding all the forecast sub-signals
- \Rightarrow One forecast sequence

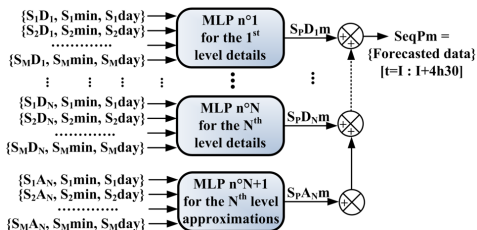

Forecasting and wavelet reconstruction

- Forecasting using multi-layer perceptrons
- Using $N+1$ MLP for a N -level wavelet decomposition
- Adding all the forecast sub-signals
- \Rightarrow One forecast sequence

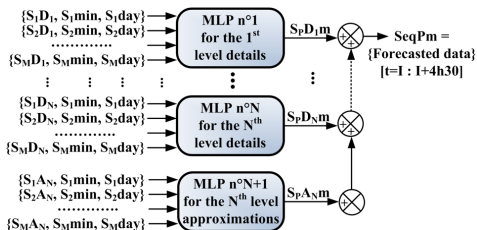

Optimization of parameters

- Best configuration for T_{out} et P_{DN}

Parameter	Symbol	Optimal value
Wavelet order	R	4
Wavelet decomposition level	N	5
Number of hidden neurons by MLP	F	5
Number of past sequences	M	4
Sampling time	T_S	30 mn

- Forecasting results

Variable	FIT [%]	MRE [%]	MAE
T_{out}^{4h30}	59,8	4,2	1,2 °C
P_{DN}^{4h30}	46,9	5,85	639,1 kWh

Optimization of parameters

- Best configuration for T_{out} et P_{DN}

Parameter	Symbol	Optimal value
Wavelet order	R	4
Wavelet decomposition level	N	5
Number of hidden neurons by MLP	F	5
Number of past sequences	M	4
Sampling time	T_S	30 mn

- Forecasting results

Variable	FIT [%]	MRE [%]	MAE
T_{out}^{4h30}	59,8	4,2	1,2 °C
P_{DN}^{4h30}	46,9	5,85	639,1 kWh

Outline

- 1 Energetic context
- 2 Opti-EnR project
- 3 Modeling and identification
- 4 Thermal storage tank model
- 5 Forecasting exogenous variables
- 6 Control and optimization
 - Optimization criteria
 - Model Predictive Controller (MPC)
 - Results

Fuel characteristics

Criterion	Unit	Wood	Gas	Fuel oil (DFO)
Energy density (LHV)	$\text{kWh}\cdot\text{m}^{-3}$	900	10,5	9760
Economical cost	$\text{€}\cdot\text{kWh}^{-1}$	14	36	41
CO ₂ LCA	$\text{gCO}_2\cdot\text{kWh}^{-1}$	13	234	270

Fuel characteristics

Criterion	Unit	Wood	Gas	Fuel oil (DFO)
Energy density (LHV)	kWh·m ⁻³	900	10,5	9760
Economical cost	€·kWh ⁻¹	14	36	41
CO ₂ LCA	gCO ₂ ·kWh ⁻¹	13	234	270

Fuel characteristics

Criterion	Unit	Wood	Gas	Fuel oil (DFO)
Energy density (LHV)	kWh·m ⁻³	900	10,5	9760
Economical cost	€·kWh ⁻¹	14	36	41
CO ₂ LCA	gCO ₂ ·kWh ⁻¹	13	234	270

Definition of criteria

- **Economical criterion : production cost**

$$J_1 = UC_{wood} \times N_{tappet} + UC_{gas} \times V_{gas} + UC_{fuel} \times V_{fuel}$$

- Technical criterion : error on hot water temperature

$$J_2 = \frac{1}{2 \cdot N} \cdot \sum_{k=1}^N (|T_{DN}^{SP}(k) - T_{DN}(k)| - (T_{DN}(k) - T_{DN}^{SP}(k)))$$

- Energetic criterion A : total energy consumed

$$J_3 = ULHV_{wood} \times N_{tappet} + ULHV_{gas} \times V_{gas} + ULHV_{fuel} \times V_{fuel}$$

- Energetic criterion B : fossil energy cover rater

$$J_4 = \frac{ULHV_{gas} \times V_{gas} + ULHV_{fuel} \times V_{fuel}}{ULHV_{wood} \times N_{tappet} + ULHV_{gas} \times V_{gas} + ULHV_{fuel} \times V_{fuel}}$$

- Environmental criterion : CO₂ emissions

$$J_5 = ULCA_{wood} \times N_{tappet} + ULCA_{gas} \times V_{gas} + ULCA_{fuel} \times V_{fuel}$$

- Mixed criterion

$$J_6 = \frac{1}{5} \times \sum_{n=1}^5 100 \times \frac{J_n(\text{with thermal storage})}{J_n(\text{without thermal storage})}$$

Definition of criteria

- Economical criterion : production cost

$$J_1 = UC_{wood} \times N_{tappet} + UC_{gas} \times V_{gas} + UC_{fuel} \times V_{fuel}$$

- Technical criterion : error on hot water temperature

$$J_2 = \frac{1}{2 \cdot N} \cdot \sum_{k=1}^N (|T_{DN}^{SP}(k) - T_{DN}(k)| - (T_{DN}(k) - T_{DN}^{SP}(k)))$$

- Energetic criterion A : total energy consumed

$$J_3 = ULHV_{wood} \times N_{tappet} + ULHV_{gas} \times V_{gas} + ULHV_{fuel} \times V_{fuel}$$

- Energetic criterion B : fossil energy cover rater

$$J_4 = \frac{ULHV_{gas} \times V_{gas} + ULHV_{fuel} \times V_{fuel}}{ULHV_{wood} \times N_{tappet} + ULHV_{gas} \times V_{gas} + ULHV_{fuel} \times V_{fuel}}$$

- Environmental criterion : CO₂ emissions

$$J_5 = ULCA_{wood} \times N_{tappet} + ULCA_{gas} \times V_{gas} + ULCA_{fuel} \times V_{fuel}$$

- Mixed criterion

$$J_6 = \frac{1}{5} \times \sum_{n=1}^5 100 \times \frac{J_n(\text{with thermal storage})}{J_n(\text{without thermal storage})}$$

Definition of criteria

- Economical criterion : production cost

$$J_1 = UC_{wood} \times N_{tappet} + UC_{gas} \times V_{gas} + UC_{fuel} \times V_{fuel}$$

- Technical criterion : error on hot water temperature

$$J_2 = \frac{1}{2 \cdot N} \cdot \sum_{k=1}^N (|T_{DN}^{SP}(k) - T_{DN}(k)| - (T_{DN}(k) - T_{DN}^{SP}(k)))$$

- Energetic criterion A : total energy consumed

$$J_3 = ULHV_{wood} \times N_{tappet} + ULHV_{gas} \times V_{gas} + ULHV_{fuel} \times V_{fuel}$$

- Energetic criterion B : fossil energy cover rater

$$J_4 = \frac{ULHV_{gas} \times V_{gas} + ULHV_{fuel} \times V_{fuel}}{ULHV_{wood} \times N_{tappet} + ULHV_{gas} \times V_{gas} + ULHV_{fuel} \times V_{fuel}}$$

- Environmental criterion : CO₂ emissions

$$J_5 = ULCA_{wood} \times N_{tappet} + ULCA_{gas} \times V_{gas} + ULCA_{fuel} \times V_{fuel}$$

- Mixed criterion

$$J_6 = \frac{1}{5} \times \sum_{n=1}^5 100 \times \frac{J_n(\text{with thermal storage})}{J_n(\text{without thermal storage})}$$

Definition of criteria

- Economical criterion : production cost

$$J_1 = UC_{wood} \times N_{tappet} + UC_{gas} \times V_{gas} + UC_{fuel} \times V_{fuel}$$

- Technical criterion : error on hot water temperature

$$J_2 = \frac{1}{2 \cdot N} \cdot \sum_{k=1}^N (|T_{DN}^{SP}(k) - T_{DN}(k)| - (T_{DN}(k) - T_{DN}^{SP}(k)))$$

- Energetic criterion A : total energy consumed

$$J_3 = ULHV_{wood} \times N_{tappet} + ULHV_{gas} \times V_{gas} + ULHV_{fuel} \times V_{fuel}$$

- Energetic criterion B : fossil energy cover rater

$$J_4 = \frac{ULHV_{gas} \times V_{gas} + ULHV_{fuel} \times V_{fuel}}{ULHV_{wood} \times N_{tappet} + ULHV_{gas} \times V_{gas} + ULHV_{fuel} \times V_{fuel}}$$

- Environmental criterion : CO₂ emissions

$$J_5 = ULCA_{wood} \times N_{tappet} + ULCA_{gas} \times V_{gas} + ULCA_{fuel} \times V_{fuel}$$

- Mixed criterion

$$J_6 = \frac{1}{5} \times \sum_{n=1}^5 100 \times \frac{J_n(\text{with thermal storage})}{J_n(\text{without thermal storage})}$$

Definition of criteria

- Economical criterion : production cost

$$J_1 = UC_{wood} \times N_{tappet} + UC_{gas} \times V_{gas} + UC_{fuel} \times V_{fuel}$$

- Technical criterion : error on hot water temperature

$$J_2 = \frac{1}{2 \cdot N} \cdot \sum_{k=1}^N (|T_{DN}^{SP}(k) - T_{DN}(k)| - (T_{DN}(k) - T_{DN}^{SP}(k)))$$

- Energetic criterion A : total energy consumed

$$J_3 = ULHV_{wood} \times N_{tappet} + ULHV_{gas} \times V_{gas} + ULHV_{fuel} \times V_{fuel}$$

- Energetic criterion B : fossil energy cover rater

$$J_4 = \frac{ULHV_{gas} \times V_{gas} + ULHV_{fuel} \times V_{fuel}}{ULHV_{wood} \times N_{tappet} + ULHV_{gas} \times V_{gas} + ULHV_{fuel} \times V_{fuel}}$$

- Environmental criterion : CO₂ emissions

$$J_5 = ULCA_{wood} \times N_{tappet} + ULCA_{gas} \times V_{gas} + ULCA_{fuel} \times V_{fuel}$$

- Mixed criterion

$$J_6 = \frac{1}{5} \times \sum_{n=1}^5 100 \times \frac{J_n(\text{with thermal storage})}{J_n(\text{without thermal storage})}$$

Definition of criteria

- Economical criterion : production cost

$$J_1 = UC_{wood} \times N_{tappet} + UC_{gas} \times V_{gas} + UC_{fuel} \times V_{fuel}$$

- Technical criterion : error on hot water temperature

$$J_2 = \frac{1}{2 \cdot N} \cdot \sum_{k=1}^N (|T_{DN}^{SP}(k) - T_{DN}(k)| - (T_{DN}(k) - T_{DN}^{SP}(k)))$$

- Energetic criterion A : total energy consumed

$$J_3 = ULHV_{wood} \times N_{tappet} + ULHV_{gas} \times V_{gas} + ULHV_{fuel} \times V_{fuel}$$

- Energetic criterion B : fossil energy cover rater

$$J_4 = \frac{ULHV_{gas} \times V_{gas} + ULHV_{fuel} \times V_{fuel}}{ULHV_{wood} \times N_{tappet} + ULHV_{gas} \times V_{gas} + ULHV_{fuel} \times V_{fuel}}$$

- Environmental criterion : CO₂ emissions

$$J_5 = ULCA_{wood} \times N_{tappet} + ULCA_{gas} \times V_{gas} + ULCA_{fuel} \times V_{fuel}$$

- Mixed criterion

$$J_6 = \frac{1}{5} \times \sum_{n=1}^5 100 \times \frac{J_n(\text{with thermal storage})}{J_n(\text{without thermal storage})}$$

Functioning synoptic

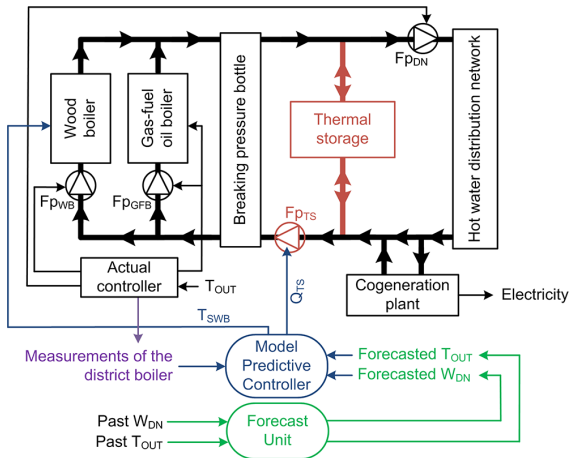

Optimization problem

- Objective function

$$\min (J_1 = PU_{wood} \times N_{lappet} + PU_{gas} \times V_{gaz} + PU_{DFO} \times V_{DFO})$$

- Optimization variables (controlled variables)

$$\left(\begin{array}{l} \Delta Q_{TS}(k/k), \dots, \Delta Q_{TS}(k+c-1/k) \\ \Delta T_{WB}^{SP}(k/k), \dots, \Delta T_{WB}^{SP}(k+c-1/k) \end{array} \right)$$

- Constraints

$$\left\{ \begin{array}{l} \text{Plant model with } T_{out}^{4h30} \text{ et } P_{DN}^{4h30} \text{ as inputs} \\ 0 \leq Q_{TS}(k+i/k) \leq Q_{TS-max} = Q_{DN} - 10 \quad \forall i \in \llbracket 0, \dots, p-1 \rrbracket \\ (Eng_{GB}(k+i/k) = 1) \vee (T_{BPP}^{out}(k+i/k) \leq T_{TS}^{up}(k+i/k)) \\ \Rightarrow Q_{TS}(k+i/k) \leq 0 \quad \forall i \in \llbracket 0, \dots, p-1 \rrbracket \\ 90^\circ\text{C} \leq T_{WB}^{SP} \leq 97^\circ\text{C} \quad \forall i \in \llbracket 0, \dots, p-1 \rrbracket \\ \Delta Q_{TS}(k+h) = 0 \quad \forall h \in \llbracket c, \dots, p-1 \rrbracket \\ \Delta T_{WB}^{SP}(k+h) = 0 \quad \forall h \in \llbracket c, \dots, p-1 \rrbracket \\ p = 54 : \text{predictive horizon} = 4h30 \\ c = 36 : \text{control horizon} = 3h \end{array} \right.$$

Remarkable results

Time: from 16 January to 2 March, 2009

Criteria		Configurations			
Name	Unit	Reference	MPC_1	MPC_2	MPC_3
V_{tot}	m^3	0	1000	1500	4000
N_{tappet}	-	24 635	21 260	21 203	21 482
V_{gas}	m^3	38 001	17 553	17 533	17 207
V_{fuel}	l	3287	2043	2244	2436
J_1	k€	61.62	47.10	47.07	47.54
J_2	°C	0.56	0.247	0.252	0.272
J_3	MW·h	3712	3036	3030	3066
J_4	%	11.6	6.73	6.80	6.67
J_5	tCO ₂	139.1	82.9	83.3	83.6
J_6	%	100	64.0	64.3	65.2

Conclusion and future work

- Conclusion
 - Modeling of the district boiler using experimental data
 - Adding an energetic storage model
 - Forecasting exogenous variables
 - Optimization of the plant with a predictive controller
- Future work
 - Using other storage system
 - Developing other control schemes
 - Generalizing this methodology for other plants
 - Implementing the controller in-situ

Conclusion and future work

- Conclusion
 - Modeling of the district boiler using experimental data
 - Adding an energetic storage model
 - Forecasting exogenous variables
 - Optimization of the plant with a predictive controller
- Future work
 - Using other storage system
 - Developing other control schemes
 - Generalizing this methodology for other plants
 - Implementing the controller in-situ

Related publications



Julien Eynard, Stéphane Grieu & Monique Polit.

Wavelet-based multi-resolution analysis and artificial neural networks for forecasting temperature and thermal power consumption

Engineering Applications of Artificial Intelligence, 24(3), April 2011, 501–516,
ISSN 0952-1976, DOI : 10.1016/j.engappai.2010.09.003



Julien Eynard, Stéphane Grieu & Monique Polit.

Modular approach for modelling a multi-energy district boiler

Applied Mathematical Modeling, 35(8), August, 3926–3957
ISSN 0307-904X, DOI : 10.1016/j.apm.2011.02.006

Thank you for your attention