



HAL
open science

Upgrading mixed ventilation systems in industrial conditioning

Antonio C. Caputo, Pacifico M. Pelagagge

► **To cite this version:**

Antonio C. Caputo, Pacifico M. Pelagagge. Upgrading mixed ventilation systems in industrial conditioning. Applied Thermal Engineering, 2010, 29 (14-15), pp.3204. 10.1016/j.applthermaleng.2009.04.025 . hal-00621296

HAL Id: hal-00621296

<https://hal.science/hal-00621296>

Submitted on 10 Sep 2011

HAL is a multi-disciplinary open access archive for the deposit and dissemination of scientific research documents, whether they are published or not. The documents may come from teaching and research institutions in France or abroad, or from public or private research centers.

L'archive ouverte pluridisciplinaire **HAL**, est destinée au dépôt et à la diffusion de documents scientifiques de niveau recherche, publiés ou non, émanant des établissements d'enseignement et de recherche français ou étrangers, des laboratoires publics ou privés.

Accepted Manuscript

Upgrading mixed ventilation systems in industrial conditioning

Antonio C. Caputo, Pacifico M. Pelagagge

PII: S1359-4311(09)00133-1
DOI: [10.1016/j.applthermaleng.2009.04.025](https://doi.org/10.1016/j.applthermaleng.2009.04.025)
Reference: ATE 2792

To appear in: *Applied Thermal Engineering*

Received Date: 13 February 2008
Accepted Date: 9 April 2009

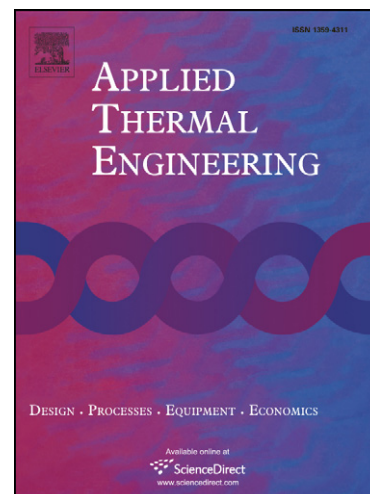

Please cite this article as: A.C. Caputo, P.M. Pelagagge, Upgrading mixed ventilation systems in industrial conditioning, *Applied Thermal Engineering* (2009), doi: [10.1016/j.applthermaleng.2009.04.025](https://doi.org/10.1016/j.applthermaleng.2009.04.025)

This is a PDF file of an unedited manuscript that has been accepted for publication. As a service to our customers we are providing this early version of the manuscript. The manuscript will undergo copyediting, typesetting, and review of the resulting proof before it is published in its final form. Please note that during the production process errors may be discovered which could affect the content, and all legal disclaimers that apply to the journal pertain.

UPGRADING MIXED VENTILATION SYSTEMS IN INDUSTRIAL CONDITIONING

Antonio C. Caputo – caputo@ing.univaq.it

Pacifico M. Pelagagge – pelmar@ing.univaq.it

Department of Mechanical, Energy and Management Engineering,
University of L'Aquila, Italy.

***Abstract.** Mixing ventilation systems (MVS) involve injecting cold air from the upper part of the room. The resulting turbulent mixing of the cold stream with ambient air determines a cooling of the whole volume and establishes an uniform temperature level with a very low vertical temperature gradient. While this method is commonly practiced it may not be energy efficient as the entire room volume gets cooled while often only the lower room volume, occupied by personnel at the shop floor level, needs conditioning. This may be a severe drawback especially in high ceiling buildings and when process equipment with high thermal loads are utilized. In this paper an easily retrofitted improvement solution to existing MVS, called Retrofit Hybrid Displacement Ventilation System (RHDVS) is suggested and compared with a traditional MVS taking into account technical and economic performances. The study was carried out resorting to experimental measurements on a single diffuser pilot installation of the RHDVS in an actual industrial facility, to characterize the existing MVS and estimate the performance improvement obtainable with the proposed RHDVS. An economic analysis was finally performed to assess the retrofit economic feasibility in case it is extended to the entire plant. Respect mixing ventilation, a reduction of the air flow rate cooling requirement*

from 12 to 6 kJ/kg resulted in the considered application, with an average cost saving of 50.000 €/yr. A pay back time of less than 1 year followed, making the upgrade to RHDVS an interesting alternative.

Keywords: *Mixing ventilation, Displacement ventilation, Economic analysis, Industrial ventilation, Retrofit.*

1. INTRODUCTION

During summer months a ventilation system is required in most industrial facilities to maintain comfortable conditions in the workplace. Usually this is carried out resorting to a Mixing Ventilation System (MVS). Mixing ventilation involves cold air injection from the upper part of the room, and exhaust of warm air from grilles located at ceiling or floor level according to the specific building requirements (Figure 1). Turbulent mixing of the cold stream with ambient air determines the uniform cooling of the whole volume. The energy expenditure can thus be relevant, especially when high ceiling buildings are considered or when high thermal loads exist in the shop floor, because a fairly constant temperature level is achieved in the entire room volume, with negligible vertical temperature gradient, and even the upper part of the room, not occupied by people, gets unnecessarily cooled.

An alternative ventilation method is the Displacement Ventilation System (DVS) which involves injection of cold air in the lower part of the room, in proximity of the floor, through proper diffusers, while the heat sources in the room cause upward moving convection flows transporting warmer and polluted air from the lower part of the room to the upper part from where it is exhausted. The resulting air stratification effect en-

ables a better indoor air quality in the lower level and the effective cooling of only the lower volume of the room, where people operate. As a result, respect a MVS the same microclimatic conditions may be obtained in the volume occupied by workers but with a lower energy expenditure.

However, the steeper vertical temperature gradient is usually the limiting factor for DVS because, the temperature difference between feet and head of workers should be limited to around 2 °C (and maintained lower than 3°C) to avoid discomfort. In practice this imposes a constraint to the performances of DVS as when the cooling load is high, the amount of air needed to keep the temperature gradient below this limit will be too large and cause problems with air handling and distribution. The sizing of DVS is therefore a delicate task. In the past it has been mainly carried out by full scale experiments and resorting to experience. However, engineering design methods and guidelines have been developed and are available in the literature [1-5] while numerical analysis methods have also been investigated [6]. Furthermore, displacement ventilation has been analyzed in conjunction with chilled ceilings [7-9] proving the effectiveness of this approach.

As previously stated, the main benefit of DVS respect a MVS is that, owing to the temperature stratification effect, only a fraction of total heat loads considered in the MVS are to be satisfied. This enables substantial energy savings as the injection of a warmer and lower flow rate of cooling air may be allowed while maintaining satisfactory microclimatic conditions. This advantage becomes even more relevant in high-ceiling buildings where, otherwise, the entire room volume would be cooled uniformly by the MVS even in the upper room portion where people are not present. However, very little performance data exist for displacement ventilation in high-ceiling rooms

(from 5 to 20 m) which are characteristic of many industrial facilities. In this field Arens [10] presented experimental measurements of temperature, concentration and velocity in office and manufacturing settings to judge the suitability of displacement ventilation referring to a 6.5 m high room.

Despite the above cited benefits, in practice the conversion from a MVS to a DVS in a building is constrained by the existing mixing ventilation ductworks, which often can not be dismissed owing to economic reasons. A more viable alternative can therefore consist in adopting a Retrofit Hybrid Displacement Ventilation System (RHDVS) where modified air diffusers are installed onto the existing air conveying ductworks to improve the flow distribution and move from a pure MVS to a hybrid flow regime partially resembling that of a DVS and characterized by a rather marked vertical temperature gradient so that temperature in the upper part of the room can be maintained higher than that at the lower level thus guaranteeing workers comfort while reducing energy expense.

In order to assess the feasibility of such a solution, a RHDVS arrangement has been here proposed and compared with a traditional MVS from a technical and economic performances point of view in an industrial setting.

In the paper, at first the proposed RHDVS is described. An experimental case study is then considered where an industrial facility is to be ventilated, and the possibility of changing the traditional MVS with a RHDVS is assessed as a means to upgrade system performances and obtain energy and economic savings. After describing the case study

environment, an experimental campaign is presented to characterize the existing MVS and estimate the performance of a RHDVS based on the test of a pilot RHDVS diffuser. Results of the experimental measurements are then compared in order to appraise the improvement potential obtainable with the RHDVS. The performance improvement was assessed referring mainly to the obtained vertical temperature gradient in the lower part of the room (up to a height of 2 meters) to verify that suitable temperatures in the workers space and higher temperatures in the upper part of the room could be obtained while simultaneously increasing the cooling air temperature in order to enjoy energy savings. A questionnaire was also administrated to personnel working in the department to evaluate the change of perceived thermal comfort. Finally, an economic analysis is presented in order to assess the economic feasibility of the proposed solution in case it is extended to the entire examined plant. The analysis included estimation of capital investment and operating expenses and was based on the comparison of energy expenditures of both system to compute expected savings and evaluate the pay back time of the retrofit solution.

2. RETROFIT HYBRID DISPLACEMENT VENTILATION SYSTEMS IN INDUSTRIAL VENTILATION

The general arrangement of an RHDVS when applied to an existing MVS fitted with floor mounted aspiration grilles is depicted in Figure 2. In this hybrid solution cold air is injected at middle level in the room through additional diffusers fitted to the existing mixing ventilation ductwork, and is exhausted from wall-mounted air extraction grilles located at floor level. Therefore the proposed system, with diffuser at mid level

of the room and floor mounted aspiration grilles, can not be considered a displacement ventilation system and the resulting flow pattern is not a pure displacement flow.

However, this peculiar arrangement gives rise to a flow regime which is intermediate between that of pure DVS and MVS, because even if the air injection is in the upper part of the room and air extraction is from the lower part, which is the opposite of what happens in pure displacement ventilation system, the location of diffusers at mid level maintains some of the advantages of displacement ventilation. In fact, the following results characteristic of displacement ventilation are obtained, i.e. promoting a stronger convective flow near the heat sources, having a steeper vertical temperature gradient, avoiding temperature control of the entire room volume with resulting energy savings, and improving the air quality in the area occupied by operators. Therefore we consider a modified mixing ventilation which in part behaves like a displacement ventilation system and this is obtained with minimum modification to existing ductwork which is the main constraint preventing to adopt a pure displacement ventilation system in such retrofit applications.

However, while this solution is significant because it is frequently encountered in case of existing MVS upgrade, it makes hardly applicable the traditional DVS design methods, while some resemblance may be found with impinging jet ventilation [11]. Impinging jet ventilation systems (IJVS) are based on the principle of supplying a jet of air with high momentum downwards onto the floor. As the jet impinges onto the floor it spreads over a large area causing the jet momentum to recede but still has sufficient force to reach suitable distances (in the order of a few meters) and continue pass the heat sources without being totally consumed by the plume rising from the heat source as

happens in VDS [11]. Nevertheless it should be pointed out that the proposed system is significantly different from an IJVS .

In fact IJVS eject a downward pointing jet, while the proposed system adopts a mainly radially flowing stream. IJVS adopts down-to-floor ducts where the vertical distance between supply outlet and the floor is less than one meter while in the proposed system the diffuser is placed at a much higher level (more than 3 meters). IJVS utilizes wall mounted ducts while the proposed system adopts free standing vertical ducts descending from ceiling mounted ductworks.

IJVS adopt floor level air injection and ceiling level air exhaust (as happens in DVS) while in the proposed system air is injected at mid level and extracted at floor level.

On the other hand, IJVS adopting wall mounted ducts are not suited to large sized rooms owing to the large average distance from the generic floor point to the walls. In fact the fairly rapid decay of flow velocity along the floor implies that only locations within a few meters from the supply duct are well ventilated. This is acceptable in smaller sized rooms but not in larger buildings.

A solution could be to utilize IJVS with ducts descending from the ceiling in the middle of the room instead of using wall mounted ducts. However the requirement for IJVS to have the supply outlet at short distance from the floor would impose an unacceptable obstacle to the free movement of people and materials on the shop floor. In the proposed system, instead the supply ducts are placed at intermediate level and do not represent any obstacle on the shop floor. This gives an added degree of freedom to conveniently locate the diffusing ducts near the equipments representing the major heat sources irrespective of the plant layout configuration.

Therefore, even if IJVS are a satisfactory alternative to DVS and may show even superior performances, given the higher momentum of the air stream and the thinner layer of air over the floor [11], they may not represent a viable solution in the kind of industrial applications considered in this work.

Therefore, the ventilation system can be sized resorting to typical performance charts of ceiling mounted diffusers with horizontal air ejection (Figure 3). In a typical case assuming a flow rate of about 7000 m³/h per diffuser, a ΔT of 3 °C can be obtained within a radius of 7.5 m, a ΔT of 5 °C within 5 m, and a ΔT of 6 °C within a 4.5 m radius, with an air velocity falling below 0.15 m/s at heights lower than 1.8 m (Figure 4).

This ensures that a proper air recirculation occurs at the head level of personnel without surpassing the discomfort threshold of 0.15 m/s.

3. CASE STUDY

While the adoption of a RHDVS is conceptually valid, to verify the actual feasibility and profitability of upgrading an existing MVS, a detailed analysis was carried out by referring to a specific case study to gather experimental data.

3.1 Characterization of the case study environment

The analysis involved the facilities of a leading Italian manufacturer of personal care items such as sanitary napkins and baby diapers. The facilities include three separate buildings housing several manufacturing lines. Building A has a surface of 10.000 m², Building B has a surface of 11.000 m², while building C has a floor area of about 9100 m². This study refers to building C, which shares the Heating, Ventilation and Air Conditioning (HVAC) plant with building B. The choice of focusing on building C is

dictated by the great non-uniformity of heat loads existing in this department owing to the presence of glue melting ovens with a high radiated power which make it the most critical plant area. In fact, if the existing average environmental conditions (air temperature of 23 °C, radiant air temperature of 23 °C, air velocity of 0.1 m/s, RH of 40%) are rated according to EN ISO 7730 standard, with a physical activity level of 1.6 met and light clothing (0.9 clo), a Predicted Mean Vote of 0.6 and a Predicted Percentage of Dissatisfied people of 12.5% result. These value would indicate that environmental conditions could be perceived as fairly comfortable. However, at the workplaces near the glue ovens air temperature reaches 29.5 °C and RH 31.5%, while at the edges of the department temperature falls to 22.6 °C with 42.6% RH. Intermediate values of temperature and RH are obtained instead in proximity of the manufacturing lines. This makes the working conditions in the department quite uncomfortable for line operators even if the average room conditions are fairly satisfactory.

Building C room has a rectangular shape with sides 75x131 m long and average ceiling height of 7.5 m and houses 12 production lines.

The HVAC system is a MVS comprising eight air treatment units (ATU), each processing a flowrate of 75.000 m³/h, thus delivering an overall injected air flowrate of 600.000 m³/h. Air is aspirated in part by machine mounted hoods and in part through wall-mounted grilles at floor level. An excess flow rate is injected to maintain a slight overpressure respect outdoor ambient pressure. The ATUs carry out the treatment of the mixture of external and recirculated air by performing in sequence a mixing of recirculated and external streams, filtration, pre-heating, cooling and dehumidification, adiabatic humidification, post-heating, before conveying the stream through a fan to the distribution network. The flow rate is conveyed inside the room through a set of a rectan-

gular cross section air ducts mounted right below the ceiling and fitted with supply vents, dispensing about $3000 \text{ m}^3/\text{h}$ each. The jet exiting from the supply outlets has a conical section as it is quite distant from the floor. Therefore, any phenomena of deviation of a plan fluid jet penetrating another fluid in the vicinity of a convex wall with the tendency of the jet to stay attached to the adjacent curved surface (i.e. Coanda effect) is negligible. Figure 5 shows the layout of air distribution ducts. Cooling power is provided by four water cooled chillers and four evaporative cooling towers. Technical details of the HVAC system are resumed in Table 1.

The overall heat load generated in the room is 1426 kW. About 1410 kW emitted from manufacturing equipment, about 9 kW from lighting equipment (including 150 fluorescent lamps), and the remaining 7 kW from the 35 operators manning in average the department. This equates to an average heat load of about 157 W/m^2 . Only one side of the room faces the exterior and walls have a high thermal resistance, making negligible the outside heat transmission.

In order to achieve the desired environmental conditions in the summer period (air temperature comprised between 24°C and 26°C and 40% to 60% RH), cooling air has to be injected at a much lower temperature (about $13\text{-}14^\circ\text{C}$) causing a great energy expenditure of the refrigeration plant. In high-ceiling buildings this also means that a large percentage of the room volume in the upper section gets unnecessarily conditioned further increasing the energy expenditure. In fact, in this facility the manufacturing equipments reach a maximum height of 3.5 m and the volume occupied by people is contained within a height of 1.9 m, while the ceiling is more than 7 meters high. It can be

concluded that in this application the entire volume at height greater than 3 m, is unnecessarily conditioned (see Figure 1).

3.2 Analysis of existing MVS performances

Performances of the MVS have been evaluated in terms of flow and temperature distribution. Although the velocity of the jet coming from the duct is set at 1.5 m/s, the air velocity falls well below 0.15 m/s in the area occupied by the personnel. Such low values at floor level, while being consistent with the requirements of EN ISO 7730 thermal comfort standard, indicate an unsatisfactory rate of change of the air leading to stagnation.

This was confirmed even by a visual investigation of flow patterns carried out on the diffusers of the MVS resorting to smoke tracers. With MVS smoke was injected at a height of 6.5 m in proximity to a duct supply vent (Figures 6 and 7). Tests indicated that even if the injection velocity was quite high, the flow distribution was not uniform especially in the zones interested by personnel presence as the injected air tended to remain in the upper volume of the building. This means that flow distribution patterns do not reach effectively all areas where operators may station and prevent operators from benefiting of fresher and purer air even if energy consumption is high as the entire room volume gets cooled.

Automatic temperature sampling sensors were then installed in a specified plant location at height of 1, 2, and 4 m (Figure 8) in order to evaluate the vertical temperature gradient obtained with the existing MVS. Figure 9 shows typical temperature readings from the three sensors over a 14 hours time interval.

The average temperature measured at the low sensor was 22.9 °C, that at the intermediate sensor 23.1 °C and the average reading of the high sensor was 23.3 °C. The resulting average vertical temperature gradient with mixing ventilation is shown in Figure 10 and resulted fairly negligible (about 0.13 °C/m). This confirms that with the current MVS a thorough air mixing occurs in the entire volume and the whole air volume gets temperature-controlled instead of only the volume occupied by operators with a significant energy expenditure.

3.3 Analysis of pilot RHDVS performances

A single-diffuser pilot installation of the RHDVS was then carried out in order to gather experimental data for sake of comparison with the existing MVS. Being this a retrofit application many of the design choices were dictated by the existing plant architecture. In particular, the overall ventilation flow rate of 600.000 m³/h was a prerequisite coming from equipment operation and the necessity of overpressurization. Even the type and layout of wall-mounted air intake grilles as well as the air distribution ducts could not be changed for practical and economic reasons. As already pointed out such constraints makes the proposed ventilation plant a hybrid system as air is diffused from middle room height and exhausted from the lower part. Therefore, the only parameters to be acted upon are the type, number and location of displacement diffusers and the temperature of injected air. However, with a new more effective ventilation system, it was expected that the injected air temperature could rise so that a lower energy consumption of the air cooling plant would follow enabling economic savings.

It was decided to install the test diffuser in proximity of a glue melting oven which is the equipment generating the highest thermal load, in order to test it in the most critical scenario. The adopted diffuser had a cylindrical shape with a diameter of 510 mm and a length of 600 mm and was fitted at the extremity of a 400 mm diameter vertical duct. The installed diffuser is shown in Figure 11 while Figure 12 shows the flow regulating butterfly gate. The air stream velocity inside the diffuser body was measured as 8 m/s enabling the diffuser to eject a flow rate of 7000 m³/h with a jet velocity of 1.5 m/s. The diffuser was installed in order to have the jet ejected at 3.5 m from the floor level.

Temperature recording was repeated with the RHDVS pilot diffuser (Figure 11) and Figure 13 shows the temperature trend readings from the three sensors over a 14 hours time interval.

The average temperature measurement at the low sensor was 22.1 °C, that at the intermediate sensor 23.2 °C and the average reading of the high sensor was 24.1 °C. The average vertical temperature gradient with RHDVS is shown in Figure 10 and resulted much greater than in case of MVS (about 0.67 °C/m). This confirms that with the proposed RHDVS a significant temperature stratification effect can be obtained thus effectively cooling the volume occupied by people without cooling also the upper room volume.

Even smoke tracers experiments confirmed the improved turbulent mixing with RHDVS, with better air distribution and without stagnation areas (Figure 14).

Tests were finally performed by changing the temperature level of the injected air by acting on the enthalpy control set point of the ATU. In fact, the stream energy content, measured in terms of enthalpy, is also a measure of the energy expended by the ATU to cool, dehumidify and reheat the external and recirculated air. Thus a higher en-

thalpy of the injected stream means a lower energy burden of the ATU. It was found that the outlet stream enthalpy required to obtain the same environmental conditions on the shop floor was 42 kJ/kg with MVS and only 48 kJ/kg with RHDVS, owing to the improved air flow pattern and temperature stratification effect. This means that a higher temperature air flow can be diffused enabling a lower energy consumption of the chillers of the air cooling plant. This also enabled to compare the energy requirements of both systems. From the energy standpoint, with an average enthalpy of 54 kJ/kg of the air mixture entering the ATU (in summer conditions 60% of internal recirculated air with enthalpy level of 50 kJ/kg, and 40% of outdoor air with average enthalpy of 60 kJ/kg), the required enthalpy change has been cut by 50 % passing from 12 kJ/kg to 6 kJ/kg.

In order to assess the personnel subjective response to the new air diffusion system, a questionnaire was repeatedly administrated over a one month period to the workers of one shift (10 people). Response were the following. No one complained about the RHDVS diffuser interfering with the working activity. 75% of workers declared that the new system seemed to improve the overall thermal comfort on the workplace. About 50 % of workers declared that with RHDVS they perceived higher variation of temperature level when changing position in the workplace respect MVS. However, this can be explained by considering that only a single RHDVS diffuser was installed causing a flow non-uniformity respect the nearby working areas. Overall, 87.5% of interviewed declared that RHDVS was more efficient than MVS. The same percentage declared that no uncomfortable air streams were perceived with RHDVS and that they agreed on the installation of the RHDVS diffusers in the entire department.

Given the satisfactory results obtained with the single test diffuser even when applied in a severe and representative condition, an economic analysis was carried out to assess the economic viability of retrofitting the displacement diffuser to the entire HVAC plant.

4. ECONOMIC ANALYSIS

An economic analysis including estimation of capital investment and operating expenses was finally performed in order to assess the economic feasibility of the proposed solution in case of extension to the entire buildings B and C.

In order to size the RHDVS diffusers system it was assumed that each ATU can feed ten displacement diffusers, each one handling a flow rate of $7500 \text{ m}^3/\text{h}$. As a result 80 diffusers are thus required. Being the diffuser cost 630 €each (including diffuser, guide vane inside the air conveying duct, butterfly gate and installation onto the existing duct), the capital investments is about 50000 €

The economic and performances analysis was carried out with the assumption of modal values for the influencing variables, i.e. that the entire mass flow rate treated by the 8 ATUs is 724.560 kg/h and that the cooling plant operates during the summer period for three months 24 days a month and 24 hours per day, with an electricity cost of 0.1 €/kWh .

Therefore, the energy data and monetary expenditures shown in Table 2 could be computed for sake of comparison between MVS and RHDVS when modal values of the

influencing parameters are assumed. It follows that, in summer operation, the adoption of a RHDVS would enable an annual saving of energy related operating costs of about 50000 €

A sensitivity analysis was also carried out to evaluate the system performances when changes in the assumed parameters occur. Table 3 shows the parameters variation range while the resulting range of variation of MVS and RHDVS energy consumptions and operating costs are shown in Table 4 . The computed expected savings with RHDVS adoption, therefore, range from 33530 to 90520 €/year with an average value of about 62000 €/year.

With a yearly saving of 50300 €(the modal value) and a capital investment of 50000 €the pay back time is about 12 months, while assuming the average saving resulting from the sensitivity analysis it falls to about 9 months. These are quite satisfactory values, making the upgrade to displacement ventilation a very interesting option.

5. CONCLUSIONS

In this paper the technical and economic performances of mixing and hybrid displacement ventilation systems for cooling large industrial buildings have been compared taking as a reference a significant case study. The comparison has been carried out resorting to a systematic methodology including smoke tracers experiments and actual temperature measurements on the existing mixing ventilation plant and a pilot plant test incorporating a single displacement diffuser. Experimental results put in light that hybrid displacement ventilation is more effective in establishing a correct flow field in the area interested by personnel operation. It also allows to obtain a significant vertical

temperature gradient which makes possible to establish comfortable environmental conditions at floor level without the need for conditioning the entire room volume. This enables to increase the cooling air temperature thus reducing the power consumption of the cooling plant to gain substantial savings. A reduction of the air flow rate cooling requirement from 12 to 6 kJ/kg has resulted in case of displacement ventilation, with an expected cost saving of about 50000 - 60000 €/yr. Being the capital investment estimated in 50000 €, a pay back time of about 1 year follows. This makes the upgrade to a hybrid displacement ventilation a very interesting alternative at least to cool rooms with a high ceiling and therefore large internal volumes which make mixing ventilation a poorly cost-effective solution. Furthermore, these results may have relevance to practitioners because they refer to the kind of hybrid displacement ventilation systems which may result when pre-existent mixing ventilation systems have to be upgraded.

REFERENCES

- [1] ACGIH, Industrial ventilation – A manual of Recommended Practice. Metric version, 23rd edition, USA, 1998.
- [2] ASHRAE, Handbook. HVAC Systems and Equipment, American Society of Heating Refrigeration and Air Conditioning Engineers, USA, 2002.
- [3] E. Mundt, Displacement ventilation systems – Convections flows and temperature gradients, *Building and Environment* 30 (1995)129 – 133.
- [4] H. Skistad, Displacement Ventilation, Research Studies Press Ltd,1994.
- [5] H.Xing, H.B Awbi, Measurement and calculation of the neutral height in a room with displacement ventilation, *Building and Environment* 37 (2002) 961 – 967.

- [6] H.J. Park, D. Holland, The effect of location of a convective heat source on displacement ventilation: CFD study, *Building and Environment* 36 (2001) 883 - 889.
- [7] A. Novoselac, J. Srebric, A critical review on the performance and design of combined cooled ceilings and displacement ventilation systems, *Energy and Building* 34 (2002) 497 – 509.
- [8] S.J. Rees, P. Haves, A nodal model for displacement ventilation and chilled ceiling systems in office spaces, *Building and Environment* 36 (2001) 753 - 762.
- [9] K.Ghali, N.Ghaddar, M.Ayoub, Chilled ceiling and displacement ventilation system for energy saving: A case study, *International Journal of Energy Research* 31 (2007) 743-759.
- [10] A.D.Arens, Evaluation of displacement ventilation for use in high-ceiling facilities, Master's Thesis, Department of Mechanical Engineering, Massachusetts Institute of Technology, Cambridge, USA, 2000.
- [11] T.Karimipناه, H.B.Awbi, Theoretical and experimental investigations of impinging jet ventilation and comparison with wall displacement ventilation, *Building and Environment* 37 (2002) 1329 – 1342.

Figures captions

Figure 1 - Scheme of mixing ventilation system.

Figure 2- Scheme of the hybrid displacement ventilation system.

Figure 3 - Typical flow characteristics of diffuser with horizontal air ejection (NW = Diffuser diameter in mm).

Figure 4 - Typical flow pattern of a ceiling mounted diffuser.

Figure 5 - Layout of air distribution channels.

Figure 6 - Smoke injection at duct level.

Figure 7 - Air mixing turbulence.

Figure 8 - Temperature sensors location.

Figure 9 - Temperature readings (MVS).

Figure 10 - Vertical temperature gradient (RHDVS and MVS comparison).

Figure 11 - Temperature sensors location and RHDVS test diffuser.

Figure 12 - Butterfly gate.

Figure 13 - Temperature readings (RHDVS).

Figure 14 – Smoke flow visualization experiments with the text diffuser.

Table 1. Characterization of the HVAC system

Air distribution system	
Overall injected flow rate	600.000 m ³ /h
Hood aspirated flow rate	178.000 m ³ /h
Grille aspirated flow rate	360.000 m ³ /h
Overpressurization air flow rate	62.000 m ³ /h
Ducted air velocity	10 m/s
Temperature of injected air	13-14 °C
Air treatment units (ATU)	
Number of ATU	8
Flow rate treated by single ATU	75.000 m ³ /h
Supply vents fed by single ATU	25
Flow rate delivered by single vent	3000 m ³ /h
Chillers	
Number of chillers	4
Overall power consumption	1360 kW
Overall cooling power	5608 kW _T
Number of cooling towers	4

Table 2. Comparison of MVS and RHDVS technical-economical performances

Parameter	MVS	RHDVS
Set point air enthalpy (kJ/kg)	42	48
Chiller thermal power (kW _T)	2415.2	1207.6
Chiller power consumption (kW)	582.06	291.03
Cooling energy consumption (MWh/year)	1005.8	502.9
Energy expenditure (k€/year)	100.6	50.3

Table 3. Sensitivity analysis

Parameter	MIN	MAX
Outdoor air enthalpy (kJ/kg)	55	70
Mixture enthalpy (kJ/kg)	52	58
Energy cost (€/kWh)	0.08	0.12
Operating months of cooling plant	2.5	4.5

Table 4. Overall performance comparison

Performance	MVS	RHDVS
Cooling energy consumption (MWh/year)	698.5 – 2011.6	279.4 – 1257.2
Energy expenditure (k€/year)	55.9 – 241.4	22.3 – 150.9

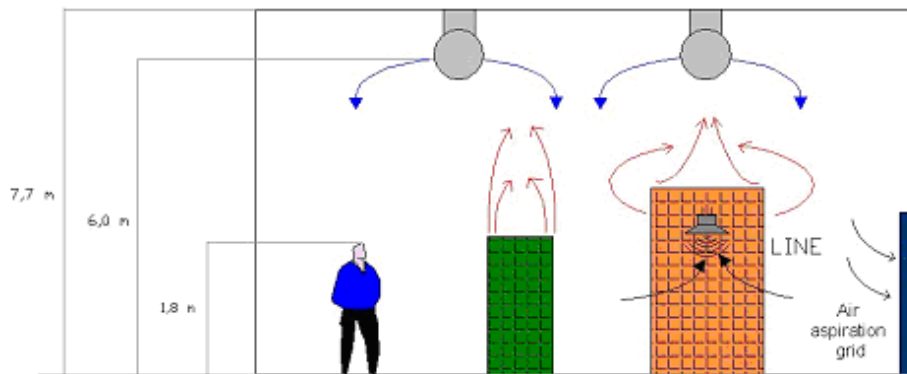

Figure 1 - Scheme of mixing ventilation system.

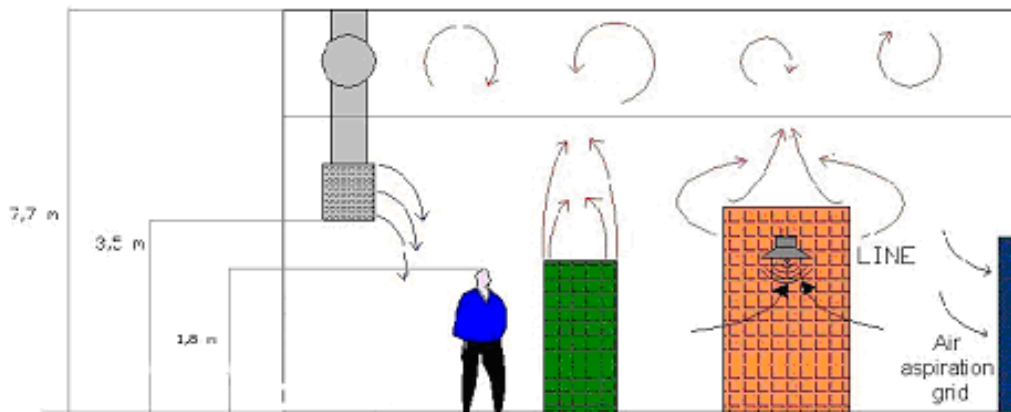

Figure 2- Scheme of the hybrid displacement ventilation system.

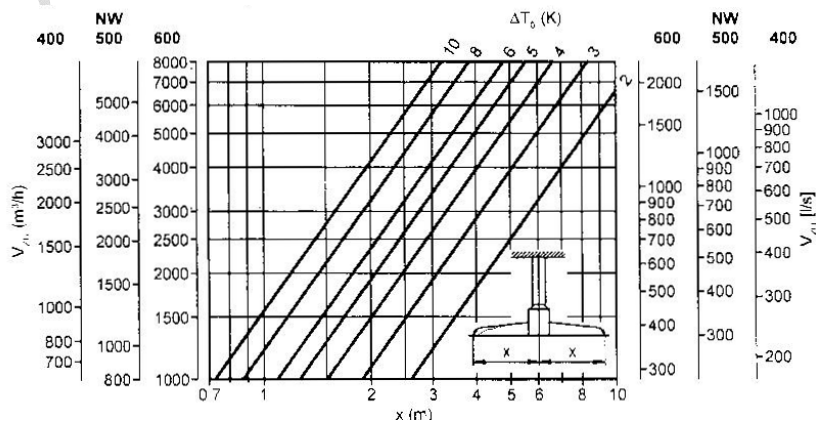

Figure 3 - Typical flow characteristics of diffuser with horizontal air ejection (NW = Diffuser diameter in mm).



Figure 6 - Smoke injection at duct level.



Figure 7 - Air mixing turbulence.

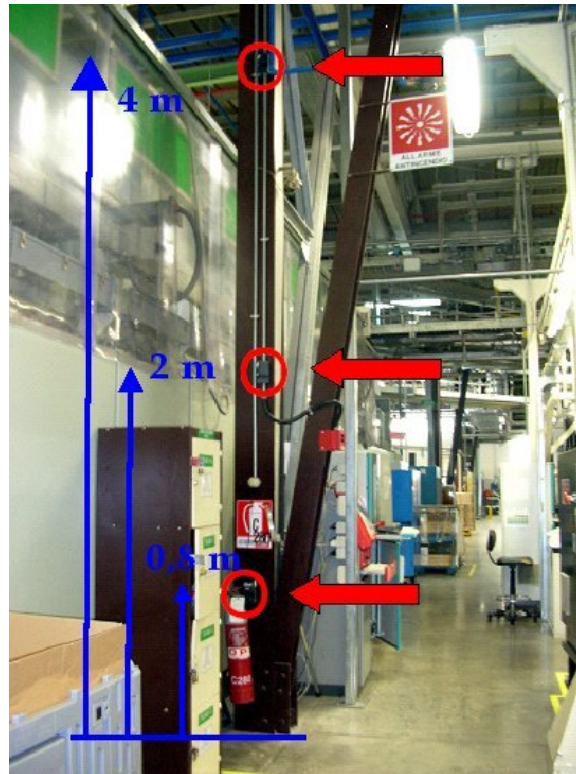

Figure 8 - Temperature sensors location.

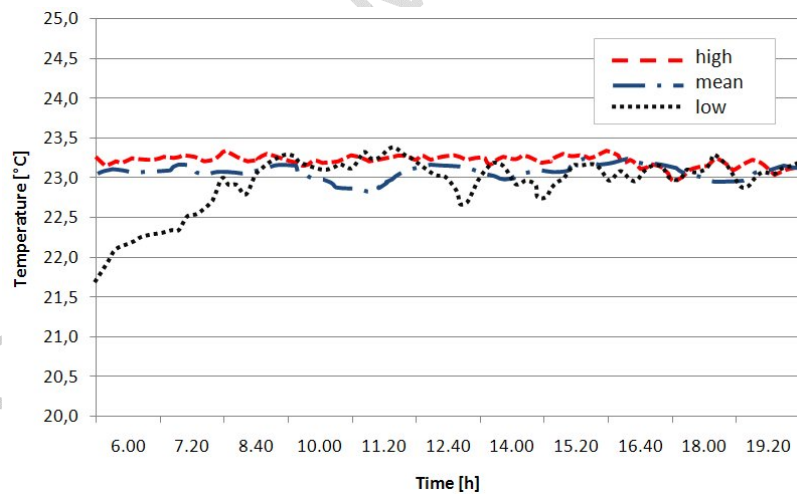

Figure 9- Temperature readings (MVS).

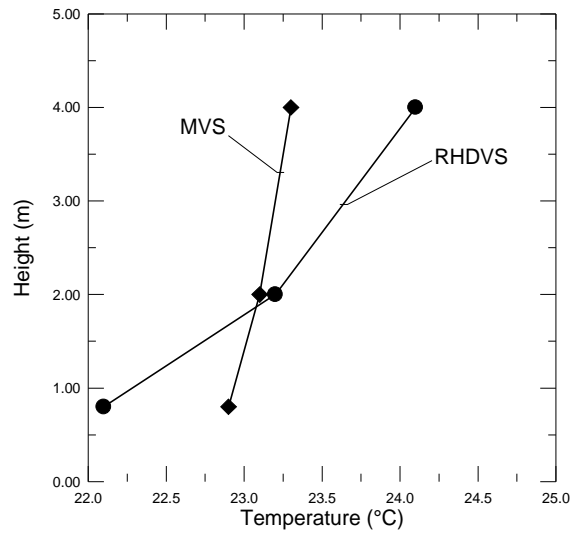

Figure 10 - Vertical temperature gradient (RHDVS and MVS comparison).

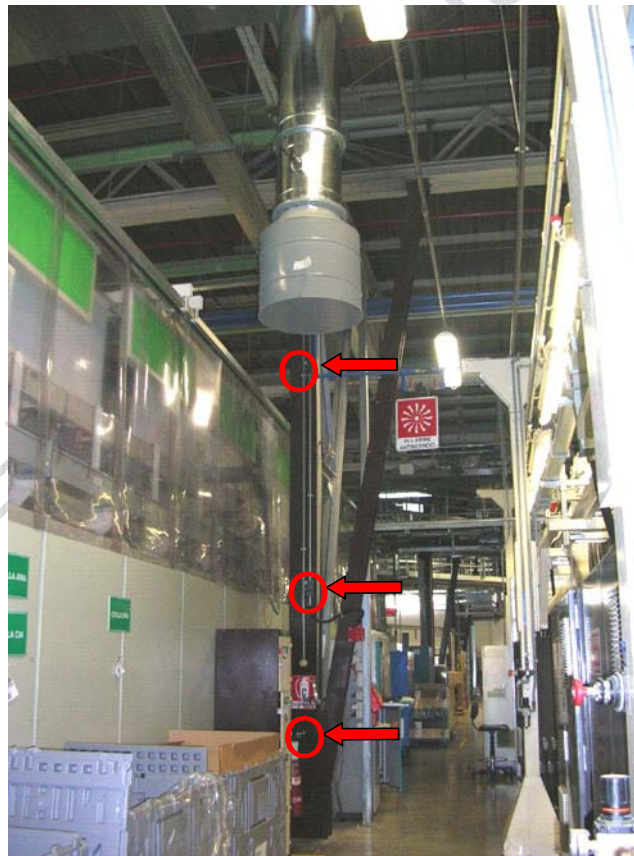

Figure 11 - Temperature sensors location and RHDVS test diffuser.



Figure 12 - Butterfly gate.

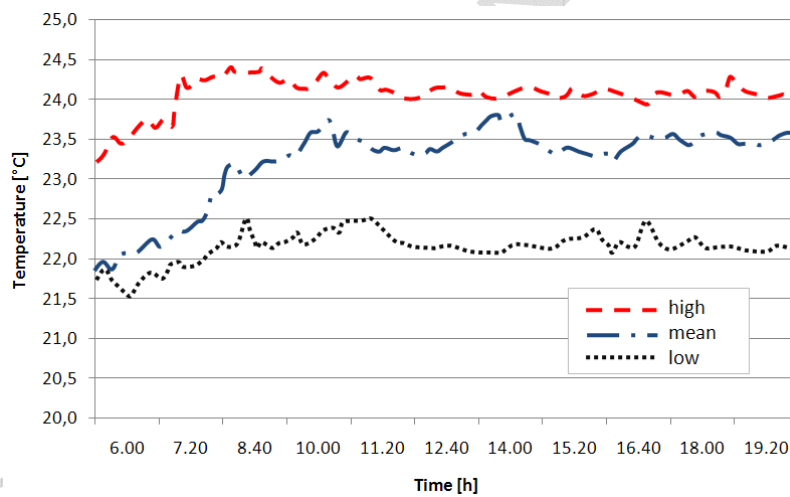

Figure 13 - Temperature readings (RHDVS).

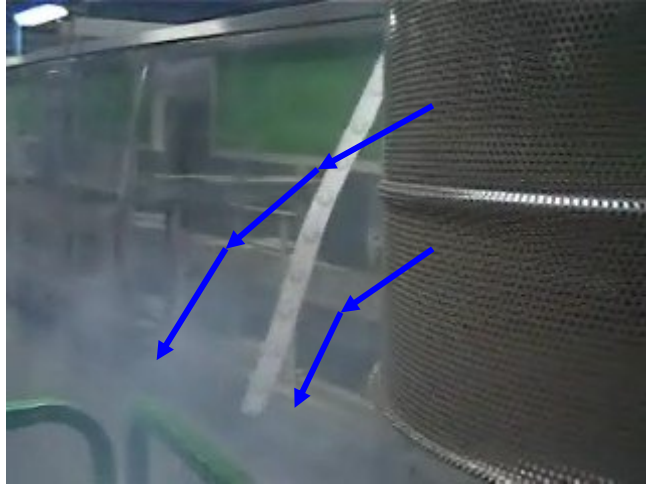

Figure 14 – Smoke flow visualization experiments with the text diffuser.

ACCEPTED MANUSCRIPT