



**HAL**  
open science

## Local Balance-Based Adaptive Control in the Heat Distribution System - Practical Validation

Jacek Czczot, Piotr Laszczyk, Mieczyslaw Metzger

► **To cite this version:**

Jacek Czczot, Piotr Laszczyk, Mieczyslaw Metzger. Local Balance-Based Adaptive Control in the Heat Distribution System - Practical Validation. Applied Thermal Engineering, 2010, 30 (8-9), pp.879. 10.1016/j.applthermaleng.2009.12.021 . hal-00621286

**HAL Id: hal-00621286**

**<https://hal.science/hal-00621286v1>**

Submitted on 10 Sep 2011

**HAL** is a multi-disciplinary open access archive for the deposit and dissemination of scientific research documents, whether they are published or not. The documents may come from teaching and research institutions in France or abroad, or from public or private research centers.

L'archive ouverte pluridisciplinaire **HAL**, est destinée au dépôt et à la diffusion de documents scientifiques de niveau recherche, publiés ou non, émanant des établissements d'enseignement et de recherche français ou étrangers, des laboratoires publics ou privés.

## Accepted Manuscript

Local Balance-Based Adaptive Control in the Heat Distribution System – Practical Validation

Jacek Czczot, Piotr Laszczyk, Mieczyslaw Metzger

PII: S1359-4311(10)00004-9  
DOI: [10.1016/j.applthermaleng.2009.12.021](https://doi.org/10.1016/j.applthermaleng.2009.12.021)  
Reference: ATE 2958

To appear in: *Applied Thermal Engineering*

Received Date: 18 September 2009  
Accepted Date: 24 December 2009

Please cite this article as: J. Czczot, P. Laszczyk, M. Metzger, Local Balance-Based Adaptive Control in the Heat Distribution System – Practical Validation, *Applied Thermal Engineering* (2010), doi: [10.1016/j.applthermaleng.2009.12.021](https://doi.org/10.1016/j.applthermaleng.2009.12.021)

This is a PDF file of an unedited manuscript that has been accepted for publication. As a service to our customers we are providing this early version of the manuscript. The manuscript will undergo copyediting, typesetting, and review of the resulting proof before it is published in its final form. Please note that during the production process errors may be discovered which could affect the content, and all legal disclaimers that apply to the journal pertain.

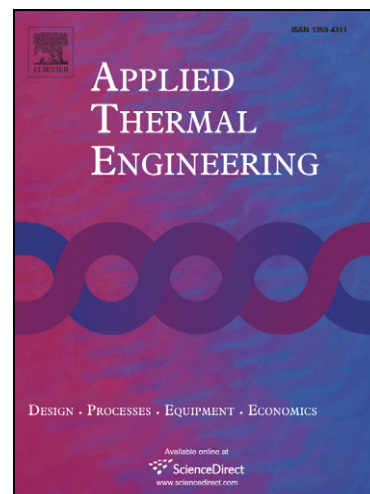

# **Local Balance-Based Adaptive Control in the Heat Distribution System – Practical Validation**

Jacek Czczot, Piotr Laszczyk, Mieczyslaw Metzger

Institute of Automatic Control

Silesian University of Technology

ul. Akademicka 16, 44-100 Gliwice, Poland

(corresponding author: e-mail: [jacek.czczot@polsl.pl](mailto:jacek.czczot@polsl.pl)).

## ABSTRACT

This paper presents the experiences from the practical implementation and the results of the experimental validation of the Balance-Based Adaptive Control (B-BAC) methodology in the application to two local control problems in the simple heat distribution system: the control of the outlet temperature for the electric flow heater and the control of a fluid flow process through the equal percentage valve. Evaluation criteria include measure of the control variable performance as well as the manipulated variable action. The results illustrate both the possibility of the practical implementation of the B-BAC methodology and the fact that in some cases this methodology ensures better disturbance rejection with the tracking properties comparable to the conventional PI controller.

Keywords: Heat distribution control, Local temperature control, Local flow control, Nonlinear adaptive model-based control, Experimental evaluation.

## 1. INTRODUCTION

The heat distribution systems are frequently applied in the industrial thermal systems and in the domestic heating-cooling systems. They usually consist of the heat source and the heat receiver and the heat distribution is controlled by the flow-based or temperature-based supervisory control application. This application ensures that the main control goal (usually the desired temperature for the receiver) is achieved but the effective supervisory control depends on the control performance of the local control loops that regulate the parameters of the heat flux incoming to the receiver. The performance of the whole control system can be improved by the appropriate tuning of the local controllers or by the application of the specialised/advanced control strategies [17,26], e.g. the nonlinear (adaptive) model-based controllers, such as e.g. the fuzzy control technique [5], predictive control technique [14], PI control with the feedforward action [15].

Although in the majority of local control loops in the practical heat distribution systems the properly tuned conventional PI controller ensures that the process is kept stable and that the disturbances are rejected quite satisfactorily, the further (even not very significant) improvement in the control performance always results in the economical benefits for the longer period of operation time [17]. For this reason, in the last several years, the model-based nonlinear control has achieved a status of an important technique, which promises such an improvement but still at the price of the lack of generality and of the strenuous effort needed for synthesis of the control law [3]. Even if these difficulties are overcome and the practical implementation is possible due to the increasing computing power of the modern automatic control equipment, there is still a problem how to convince industrial engineers to the application of the advanced nonlinear control strategies. The most important difficulty usually results from the fact that, in the vast majority of cases, the research activities mainly concentrate on the theoretical considerations and the simulation experiments. This approach is fully acceptable at the preliminary stage of the development of every new control strategy but it must be kept in mind that every control algorithm must be finally applied in the industrial control loop to regulate a real process. Thus, the practical implementation always should follow the stage of the preliminary simulation studies because it provides the link between theory and practice [4]. Unfortunately, in comparison to the huge number of theoretical and simulation considerations that have been reported for new model-based control strategies, still the examples of the experimental evaluation in the application to pilot plants or industrial heat distribution systems can be found in a relatively small number of publications [3]. Probably, it results from the fact that implementation and

experimentation are the most time-consuming activities, which finally may not fully confirm the simulation-based superiority of a new control strategy in the practice due to the presence of not modelled phenomena, of measurement noise and of unrecognizable dynamics and nonlinearities. Fortunately, it is possible to refer to some articles that report the practical implementation and the experimental validation of some advanced control strategies for heat distribution systems. Probably, the predictive controllers of different kind are the most frequently validated in the practice, see e.g. [1,14,23,24,27,31,32]. Another control strategy that was quite intensively validated experimentally is the Process Model-Based Control (PMBC) from Rhinehart and Riggs [28]. The example application for the heat distribution system has been reported e.g. by Paruchuri and Rhinehart, [25]. There are also the survey articles that report the comparison among different advanced control strategies in the practical applications for different systems including the local control in the heat distribution systems, see e.g. [18,30].

In this paper, the Balance-Based Adaptive Control (B-BAC) methodology from Czczot [7] is suggested for the local control in the laboratory heat distribution system. This methodology is based on the linearising approach but its superiority results from the unified but still very general balance-based form of the simplified model of a process with the only one unknown parameter representing unrecognizable balance terms and modelling inaccuracies. The on-line estimation of this parameter provides the adaptability of the control law. It is important to note that in the case of the B-BAC methodology the desired set-point value of a controlled variable is always reached without any integral action due to the compensating properties of the estimation procedure. The preliminary stage of the theoretical considerations for this methodology has been successfully completed and the details have been reported [10,11]. The control performance of the B-BAC methodology has been validated by simulation in the application to different processes, including the heat exchange and distribution processes [7,9,12] and the nonisothermal chemical reactor with the cooling jacket [8,11]. The results of those simulation experiments always illustrate that the application of the B-BAC methodology provides the significant improvement in the local control performance for every considered system. On the other hand, the wide variety of example processes used for validation shows the generality of this methodology. Due to these facts, the B-BAC methodology could be considered as an interesting alternative for the local SISO control problems that can be encountered in the industrial practice. In this paper, the experimental validation of this methodology is presented in the application to the local control in the heat laboratory heat distribution system. The control performance of the B-BAC controllers is compared with the performance of the conventional PI controller. The

results allow answering the question if it is possible to improve the control properties by the application of the B-BAController in the local control loops.

The paper is organized as follows. First, the experimental set-up with the motivation are presented and the short introduction to the B-BAC methodology is given. Then it is shown how to derive the B-BAControllers for both systems. The experimental results are presented in the next Section. Then the experiences from the practical implementation are discussed. Concluding remarks complete the paper.

## 2. EXPERIMENTAL SET-UP

Figure 1 presents the simplified diagram of the considered laboratory heat distribution plant [21]. It consists of the electric flow heater of the constant volume and of the nominal power supply  $P_{nom} = 5.5$  [kW]. The water flows through the heater with the flow rate  $F$  [L/min], which is regulated at the desired value  $Y_{F,sp}$  within the range 0 - 3.5 [L/min] by the appropriate local controller C2 and by the equal percentage control valve V1. The circulation of the hot water in this primary circuit is forced by a set of two pumps, for simplicity depicted in Fig. 1 as P1. The hot water of the temperature  $T_{out}$  [°C] flows out of the heater and is looped back through the heat exchanger where it is cooled by transferring the heat energy to the secondary circuit. It ensures that the temperature of the water  $T_{in}$  [°C] at the inlet of the heater is significantly lower while the water in the secondary circuit warms up. The plate type heat exchanger LM25-6, made by TAU Energy, consists of six plates and it provides fast dynamics. Its secondary circuit is supplied by the municipal water and the desired flow rate  $F_w$  [L/min] is adjusted by the linear control valve V2 regulated by the conventional PI controller within the range 0 - 4 [L/min]. Both the electric flow heater and the heat exchanger are adequately insulated to minimize heat losses. The steel pipelines of the diameter 15 [mm] are not insulated.

The system is equipped with standard industrial instrumentation for temperature and flow measurements at the locations presented in Fig. 1. Both flow rates  $F$  and  $F_w$  are measured using impeller flow meters coupled to transmitters. The temperatures  $T_{in}$  and  $T_{out}$  are measured in range 10 – 60 [°C] by platinum-wire resistance temperature devices (RTD) directly-coupled to 0 – 10 [V] transmitters. The control signal for the valves V1 and V2 varies within the range 4 – 20 [mA]. The power supply for the electric flow heater can be adjusted by the

thyristor-based unit controlled by the PWM (Pulse Width Modulation) algorithm. The control input signal  $P_h$  varies within the range 0 – 100 [%] of the nominal power supply  $P_{nom}$  and it is coupled to the analog output 0 – 10 [V]. The process is interfaced to a PC computer equipped with the analog I/O plug-in cards from National Instruments. The SCADA system and the control algorithms for both valves and for the electric flow heater are implemented in the LabWindows National Instruments programming environment [20].

### 3. MOTIVATION

The plant under consideration is the compact form of the practical heat distribution system with the heat source and the heat receiver. Generally speaking, the main control goal in such cases usually consists in the regulation of the heat transfer phenomenon between the primary and the secondary circuits. In the simplest case, when the heat exchanger represents the disturbed heat receiver, such as the domestic heating system or the heating/cooling jacket of a nonisothermal reactor, this supervisory control goal can be defined as the control of the temperature of the water at the outlet of the secondary circuit. In the considered system, this goal can be achieved by two possible supervisory control strategies of the parameters of the heat flux supplied from the heater to the heat exchanger. One strategy is the flow-based control approach, in which the flow rate  $F$  in the primary circuit is applied as the supervisory manipulated variable. In this case, the accurate local control of the flow rate  $F$  by the control valve  $V1$  and by the local controller  $C2$  is required. The flow rate  $F$  should track the desired set-point  $Y_{F,sp}$  adjusted by the supervisory control system. Additionally, it is important to ensure that at the same time the temperature of the water outcoming from the heater  $T_{out}$  is kept constant and equal to its set-point  $Y_{T,sp}$  by the local controller  $C1$  in the presence of the variations of the flow rate  $F$  forced by the supervisory control loop. The second possibility of the supervisory control is the temperature-based control strategy: the flow rate  $F$  should be kept constant and the temperature of the water outcoming from the heater  $T_{out}$  is applied as the supervisory manipulated variable for the heat exchanger. In this second case, the flow rate  $F$  should be kept equal to the constant set-point  $Y_{F,sp}$  by the local controller  $C2$  despite of the variations of the water pressure in the primary circuit while the local controller  $C1$  should ensure that the temperature  $T_{out}$  follows the variations of the set-point  $Y_{T,sp}$  forced by the supervisory control system.



To summarize, in both supervisory control strategies there are two correlated subsystems that must be locally controlled: the control valve V1 with the controlled variable F and the manipulated variable as the opening of the valve (local controller C2) and the electric flow heater with the controlled variable  $T_{out}$  and the manipulated variable  $P_h$  (local controller C1). In this paper, the possibility of the application of the B-BAControler as the local controller C1 or C2 is considered. Each case is experimentally investigated in terms of the specific requirements characterising both supervisory control strategies.

Additionally, let us note that in the considered heat distribution system there are also at least two practical difficulties, which degrade the control properties of the local control loops. First, the water in the primary circuit is looped back so the temperature  $T_{in}$  increases as the temperature  $T_{out}$  increases. It results in the positive feedback in the system that is limited by the fact that a heat from the hot water is partially removed by the heat exchanger. The second problem results from the location of the temperatures sensors. The sensors for the temperatures  $T_{in}$  and  $T_{out}$  are located very close to the inlet and to the outlet of the heat exchanger, which is suitable for the supervisory control of the heat receiver. However, these sensors are located in some distance (approximately about 1 [m]) from the inlet and the outlet of the chamber of the heater, which is one of the subsystems to be regulated in the local control loop with the controller C1. It results in the additional time delay in the system, varying according to the variations of the flow rate F, which also degrades the control properties. The additional difficulty also results from the variations of the gain of both subsystems according to the variations of the operating point.

#### 4. SHORT INTRODUCTION TO B-BAC METHODOLOGY

The B-BAC methodology is based on the simplified and general form of the balance-based dynamic equation describing a controlled variable Y [7,10,11]:

$$\frac{dY(t)}{dt} = \frac{1}{V(t)} F^T(t) Y_F(t) - R_Y(t). \quad (1)$$

In this model, the vector product  $\underline{F}^T(t)\underline{Y}_f(t)$  represents the recognizable terms correlated with a controlled variable  $Y$  that result from the mass or from the energy conservation law. The process takes place in a tank of the volume  $V(t)$  [m<sup>3</sup>].  $R_Y(t)$  is the unknown time-varying parameter representing unknown process nonlinearities as well as the modelling inaccuracies, such as the different order of a process dynamics or omitted or unrecognizable balance terms. The manipulated variable must be chosen as one of the elements of the vectors  $\underline{F}(t)$  or  $\underline{Y}_f(t)$  while their other elements as well as the tank volume  $V(t)$  must be measurable on-line or known by choice of the user. This requirement ensures that the model (1) has always the affine form and it can be solved for a manipulated variable very easy, without any iterative calculations.

The value of the unknown parameter  $R_Y(t)$  must be estimated on-line at discrete moments of time by the scalar form of the recursive least-squares method with the forgetting factor  $\alpha$ . This estimation procedure is based on the discretized form of Eq. (1) [6] and its properties are precisely described by Czczot [10]:

$$y_i = V_i \gamma (Y_i - Y_{i-1}) - T_R \underline{F}_i^T \underline{Y}_{F,i}, \quad (2a)$$

$$P_i = \frac{P_{i-1}}{\alpha} \left( 1 - \frac{V_i^2 T_R^2 P_{i-1}}{\alpha + V_i^2 T_R^2 P_{i-1}} \right), \quad (2b)$$

$$\hat{R}_{Y,i} = \hat{R}_{Y,i-1} - V_i T_R P_i (y_i + V_i T_R \hat{R}_{Y,i-1}). \quad (2c)$$

In the Eqs. (2a – 2c) index  $i$  denotes the discretization instant and  $T_R$  is the sampling time. The parameter  $\gamma \in (0,1]$  allows for limiting the transient approximation of the time derivative of a controlled variable  $Y$  in the cases when the measurement data is noisy or when the system is strongly nonlinear with very fast dynamics. If its value is adjusted as  $\gamma < 1$ , it does affect the value of  $y_i$  and consequently the estimation accuracy but only in the transients. The value of the parameter  $\gamma$  should be chosen on the basis of the impact of the measurement noise in the particular control system – the higher this impact is, the smaller value of  $\gamma$  should be adjusted.

The scalar form of the estimation procedure ensures accurate estimation results without any additional excitation input signals that are usually required to guarantee the persistence of excitation for the on-line multiparameter

identification [13]. The estimate  $\hat{R}_Y$  always converges to its true value  $R_Y$ , even in the steady state, with the rate of convergence depending directly on the value of the forgetting factor  $\alpha$  [10]. However, since the initial value  $\hat{R}_{Y,0}$  is unknown in the majority of cases, in the practical applications it is necessary to choose this value randomly. This problem is discussed in details further in the paper.

For the synthesis of the final form of the B-BAController we apply the linearization technique [16] in the form dedicated to the systems whose relative order is one [2]. If we assume that the control goal is to keep the controlled variable  $Y$  equal to its set-point  $Y_{sp}$ , we can suggest the stable first-order closed-loop dynamics with  $\lambda$  as the positive tuning parameter:

$$\frac{dY(t)}{dt} = \lambda(Y_{sp} - Y(t)) \quad (3)$$

and then, after combining Eqs. (1) and (3), choosing a manipulated variable and replacing the unknown parameter  $R_Y$  by its on-line estimate  $\hat{R}_Y$  we can obtain the final and explicit form of the B-BAController. This form depends on the particular process that is to be controlled and thus it cannot be given in the general form.

Let us note that in the final form of the B-BAController the integral action is not needed so the antiwind-up action is not necessary. The modelling error resulting from the simplified form of Eq. (1) is compensated by the on-line estimation of the unknown parameter  $R_Y$ . The estimate of this parameter is included in the B-BAC control law and it ensures that the regulation error is eliminated in the steady state due to the fact that the operating point of the controller is adopted to the current operating conditions of a system.

For the B-BAC methodology it is assumed that all the elements of the vector product  $\underline{F}^T(t)\underline{Y}_F(t)$  are measurable on-line or known by choice of the user. Apart from a manipulated variable and a controlled variable  $Y$ , all other elements of these two vectors are defined as the combinations of disturbing signals and thus, for the practical implementation there is a need to provide a number of sensors to ensure the feedforward action. If any of these disturbing signals cannot be measured due to the fact that appropriate sensors are too expensive or simply not accessible, there is a need to rearrange the general model (1) by re-defining the elements of the vectors  $\underline{F}(t)$  and  $\underline{Y}_F(t)$  and to apply the minimum form of the B-BAController. The terms that include the not

measurable disturbances must be removed from the balance-based part  $\underline{F}^T(t)\underline{Y}_F(t)$  and consequently they will be compensated by the estimation procedure (2a) – (2c) that incorporates the re-defined vectors  $\underline{F}(t)$  and  $\underline{Y}_F(t)$ . The only limitation results from the requirement of the B-BAC methodology that a manipulated variable must be included in the re-defined vector  $\underline{F}(t)$  or  $\underline{Y}_F(t)$  to ensure the affine form of the simplified model of a process (1). Therefore, the disturbing signals that are multiplied by a manipulated variable cannot be removed from the balance-based part of Eq. (1) and they must be measurable on-line. All other disturbances can be freely decided to be measurable or not, according to the accessibility of the appropriate sensors.

## 5. SYNTHESIS OF THE B-BAC CONTROLLER

In this Section, we present how to derive the B-BAC controller for both local control loops: the electric flow heater and the equal percentage control valve V1. Additionally, we show how to derive the minimum form of the B-BAC controller for the electric flow heater. These two systems demonstrate a variety of commonly encountered control problems, such as nonlinearity, time delays resulting from the sensors location, a significant impact of measurement noise and a large uncertainty on their mathematical description. Both processes are open-loop stable and their simplified models, standing as a basis for the B-BAC controller synthesis, are derived assuming the minimum knowledge on the phenomena taking place.

### 5.1. B-BAC controller for the electric flow heater

For both supervisory control structures, for the local control of the electric flow heater we define the outlet temperature  $Y = T_{out}$  as the controlled variable and the control goal is to keep it at the desired set-point  $Y_{T,sp}$  by manipulating the value of  $P_h$  (manipulated variable). During the B-BAC controller synthesis the flow rate  $F$  and the inlet temperature  $T_{in}$  are considered as the independent measurable disturbances because we concentrate only on the separated electric flow heater that is to be controlled and in the simplified model of the system we do not include any description for the remaining part of the pilot plant. Namely, there is no description for the heat lost, for the time-delays resulting from the sensors locations and for the relationship between the temperatures  $T_{in}$  and  $T_{out}$  (the primary circuit is closed, see Fig. 1 – lower diagram). Additionally, the dynamics of the heat exchanger is also not considered during modelling because we concentrate on the local control problem. The chamber of

the electric flow heater is assumed to be perfectly insulated and its volume is constant and approximately known. As usually in the practice, we assume that our knowledge about the mathematical description of the process is limited to the very general heat balance considerations. Especially, there is a large uncertainty both on the form and on the values of the parameters of the nonlinear description of the heating phenomenon. Furthermore, we also assume that we want to avoid the stage of the off-line identification of the process since these experiments are always time-consuming and need strenuous efforts.

The detailed synthesis of the B-BAController for the separated electric flow heater can be found in [9,12]. It is based on the general heat conservation equation balancing all the recognizable terms resulting from the heat fluxes incoming to and outgoing from the chamber of the electric flow heater (Fig. 1 – see lower diagram). This equation requires only very general knowledge on thermodynamics and, after very easy rearrangements, it results in the following general and simplified model of the process:

$$\frac{dY(t)}{dt} = \frac{F(t)}{V} (T_{in}(t) - Y(t)) + \eta P_h(t) P_{nom} - R_Y(t), \quad (4)$$

which consequently results in the following definition of the vectors:  $\underline{F}(t) = [F(t), -F(t), \eta P_{nom}]^T$ ,  $\underline{Y}_F(t) = [T_{in}(t), Y(t), P_h(t)]^T$ . The parameter  $\eta$  represents the averaged conversion efficiency between the power supply  $P_h(t) P_{nom}$  and the resulting heat flux that directly warms the liquid. It also represents the unknown parameters of the flowing liquid, such as the specific heat and the density, and the unification of the units.

Eq. (4) has the form of the general dynamic equation (1) and thus it can be a basis for the B-BAController design. After applying the B-BAC methodology, we obtain the discrete-time, explicit and final form of the B-BAController:

$$P_{h,i} = \frac{\lambda V (Y_{T,sp} - Y_i) - F_i (T_{in,i} - Y_i) + V \hat{R}_{Y,i}}{V \eta P_{nom}} \quad (5)$$

The value of  $\hat{R}_{Y,i}$  is the discrete-time estimate of the unknown parameter  $R_Y(t)$ , which represents all the unknown nonlinearities and the modelling inaccuracies in the simplified model of the electric flow heater (4). This value has to be computed by the on-line estimation procedure (2a) – (2c).

The B-BAController (5) includes the feedforward action by the inclusion of the measurable disturbances  $F$  and  $T_{in}$ . It allows us to expect the improvement of the control performance but it also requires additional sensors, which may increase the costs of the control system. Therefore, we can suggest the minimum form of the control law (5) by the slight simplification of the suggested model of the electric flow heater (4). We simply skip the terms including the flow rate  $F$  and thus we obtain the following simplified model:

$$\frac{dY(t)}{dt} = \eta P_h(t) P_{nom} - R_Y(t) \quad (6)$$

with the following re-defined vectors:  $\underline{F}(t) = [\eta P_{nom}]^T$ ,  $\underline{Y}_F(t) = [P_h(t)]^T$ . This very simple model has also the form of the general dynamic equation (1) and, after applying the B-BAC methodology, it results in the following minimum form of the B-BAController:

$$P_{h,i} = \frac{\lambda V (Y_{T,sp} - Y_i) + V \hat{R}_{Y,i}}{V \eta P_{nom}} \quad (7)$$

This minimum form requires only the measurement data of the controlled variable  $Y = T_{out}$ . Additionally, the same data is necessary for the on-line computing of the estimate  $\hat{R}_{Y,i}$  by the estimation procedure (2a) – (2c) that is now based on the simplified model (6) and re-defined vectors  $\underline{F}(t)$  and  $\underline{Y}_F(t)$ . Let us note that the minimum form of the B-BAController (17) requires the same measurement data as the conventional PI controller applied for the same control goal.

Both B-BAControllers derived in this subsection require the value of the parameter  $\eta$ . In the practice, this value is unknown and thus there is a need to choose it arbitrary within the reasonable range – it should represent the averaged gain of the system.

### 5.2. B-BAController for the liquid flow process

In the case of the equal percentage control valve V1, for both supervisory control structures we define the flow rate  $Y = F$  as the controlled variable and the local control goal is to keep this flow rate at its desired set-point  $Y_{F,sp}$ . In this application we use the percentage of the control range  $U$  within 0 – 100 [%] as the manipulated variable.

Although it is possible to suggest the complete nonlinear model of the valve by balancing the forces and pressures [19], this approach is useless for the B-BAC methodology due to the following reasons:

- such a model requires the preliminary off-line identification experiments that we decided to avoid,
- even if such a model was accessible, there would be a need to determine its parameters that usually vary in time,
- the only measurable quantity in the control system is the controlled variable  $Y = F$  and this fact additionally limits the possibility of the application of a model that requires the measurement data of disturbing parameters and/or of the forces and pressures in the valve.

Therefore, we decided to model the valve dynamics as the first-order element with the additional inclusion of the time-varying parameter  $R_Y(t)$  that compensates for the modelling inaccuracies. If for simplicity we assume the linear relationship  $F = k_U U$ , we can suggest the following simplified model for the considered valve:

$$\frac{dY(t)}{dt} = k_U U(t) - Y(t) - R_Y(t), \quad (8)$$

that leads to the following definition of the vectors:  $\underline{F}(t) = [k_U, -1]^T$ ,  $\underline{Y}_F(t) = [U(t), Y(t)]^T$ . The constant and unknown parameter  $k_U$  represents the linear relationship between the manipulated variable  $U$  and the controlled flow rate  $F$ . The model (8) has the form of the general dynamic equation (1) and thus we can directly apply the B-BAC methodology, which results in the following discrete-time and explicit form of the B-BAController:

$$U_i = \frac{\lambda(Y_{F,sp} - Y_i) + Y_i + \hat{R}_{Y,i}}{k_U} \quad (9)$$

Because the B-BAController (9) requires only the measurement data of the controlled flow rate  $F$  and it does not include any feedforward action, it can be also considered as its minimum form. As it was in the case of the electric flow heater, the value of  $\hat{R}_{Y,i}$  represents the unknown nonlinearities and modelling uncertainties in the model (8) and it must be computed by the on-line estimation procedure (2a) – (2c) based only on the same measurement data of the controlled flow rate  $F$ . The same measurement data is required for the conventional PI controller applied for the same control goal.

## 6. RESULTS

In this Section, we present the most representative results of the closed-loop experiments for both considered local control loops. For both considered systems the control performance of the B-BAControllers is compared against the conventional PI controller in terms of the requirements characterising both supervisory control structures. The choice for the comparative studies is not accidental. This conventional PI algorithm is still in use in the vast majority of local automatic control loops in the process industries ( $\approx 90\%$ ) [17,29] because of its simplicity, generality and relatively large robustness. These features combined with a large popularity allow for considering it as the benchmark for comparative studies against every new control strategy.

For comparison between the control algorithms we use the regulation time, the overshoot and the standard criteria: the integral of the absolute error (IAE) and of the absolute values of the manipulated variable changes  $\Delta MV$  (IADO) calculated in the following way:

$$IAE = \sum |Y_{sp} - Y| T_R \quad (10)$$

$$IADO = \sum |\Delta MV| T_R \quad (11)$$

During the experiments the sampling time has been set as  $T_R = 0.1$  [sec]. The conventional PI controllers have been tuned on the basis of the open-loop step response of the particular system with additional retuning by the trial and error method to ensure satisfying control performance for a wide range of the disturbances changes. The B-BAControllers have been tuned only by the trial and error method. Due to the presence of the measurement



noise it was necessary to apply the preliminary filtration of the required measurement data. The filtration was carried out by the first-order digital linear filters and the best results were achieved for the filter constant  $\lambda_F = 0.5$ . The same filters have been applied for the B-BAControllers with corresponding estimation procedures and for the conventional PI controllers.

Figures 2 through 4 present the results of the closed-loop experiments for the electric flow heater and they allow for comparison between the control performance of the B-BAController (5), its minimum form (7) and the conventional PI controller applied for the local control loop as the controller C1. Let us note that in this case the gain and the time delay in the system significantly depend on the flow rate  $F$ .

For the general and simplified models of the process (4) and (6), and consequently, for the B-BAControllers (5) and (7), we have purposely chosen the overestimated volume of the unit as  $V = 28$  [L]. It additionally introduces the modelling error, which can arise in the practice due to the fact that sometimes the volume of the unit can be unknown and difficult to determine on the basis of the geometrical dimensions. The value of the parameter  $\eta$  has been chosen as  $\eta = 1.8$ . As it was said before, this parameter represents the average gain of the system. Let us note that the simplified models (4) and (6) do not include any information about the physical parameters of the liquid as its density and specific heat. Additionally, the volume of the unit has been overestimated significantly and there is a need to unify the units of the physical quantities included in these models. Thus, it is very difficult to determine the value of  $\eta$  without preliminary off-line identification that we decided to avoid. Fortunately, due to the compensating properties of the estimation procedure, both B-BAControllers (5) and (7) are very resistant to the inaccurate choice of the value of the parameter  $\eta$  and thus we decided to set this reasonable value and to concentrate on the tuning of both controllers. The conventional PI controller has been tuned as  $k_r = 0.02$  (proportional gain) and  $T_i = 0.15$  (integral time constant). The tuning parameter for both B-BAControllers (5) and (7) have been chosen by the trial and error method as  $\lambda = 0.025$ . We tried to obtain the non-oscillatory control with possibly the most aggressive control action for the wide range of the set-point and of the disturbances variations. The lower value of  $\lambda$  resulted in slower control action while the increment of  $\lambda$  – in oscillatory behaviour leading to instability. The forgetting factor always should be kept as small as possible to ensure the highest modelling accuracy and in the considered case it was adjusted as  $\alpha = 0.1$  for both estimation procedures (2a) – (2c). Due to the significant impact of the measurement noise it was also necessary to adjust the value  $\gamma = 0.03$  for both estimation procedures to decrease the influence of the noisy measurement data on the

estimation accuracy and, consequently, on the control performance of the B-BAControllers. The increment of this value led to “noisy” control action and, consequently, to very poor control quality.

Figures 2 and 3 represent the control performance of the considered local controllers in the presence of the indicated step changes of the set-point  $Y_{T,sp}$ , which is important for the temperature-based supervisory control with the temperature  $T_{out}$  as the supervisory manipulated variable. Both experiments have been carried out for two constant but different values of the flow rate  $F$ , which allows for observing the set-point tracking for two different regions of the gain of the system. The controlled variable responses for  $F = 1$  (Fig. 2) show that all controllers have been tuned quite aggressively in this high gain region. The regulation time for both B-BAControllers is comparable while for the conventional PI controller it seems to be slightly shorter. The significant overshoot can be observed for the conventional PI controller while for both B-BAControllers the closed-loop responses are oscillatory but without any overshoots. The controlled variable responses for all considered controllers are significantly smoother for the higher disturbing flow rate  $F = 2$  (Fig. 3). They are less oscillatory and it is difficult to distinguish between particular controllers because practically they ensure the same regulation time.

Figure 4 shows the results of the rejection of the indicated step changes of the varying flow rate  $F$  for the constant temperature set-point  $Y_{T,sp} = 35$ , which is important for the flow-based supervisory control when the flow rate  $F$  is applied as the supervisory manipulated variable. In this case, the B-BAController (5) significantly outperforms the other two controllers providing superior disturbance rejection. The overshoots in this case are slightly smaller than for the minimum form of the B-BAController (7) and significantly smaller than for the conventional PI controller. This result is quite obvious due to the fact that the B-BAController (5) applies the additional disturbances measurement data as the feedforward action. However, let us note that the minimum form of the B-BAController (7), which applies only the measurement data of the controlled variable  $Y$ , also outperforms the conventional PI controller that requires exactly the same measurement data.

The results of the closed-loop experiments for the equal percentage control valve are presented in Figures 5 through 7. The gain of the system significantly varies according to the pressure forced by the set of two pumps (see Fig. 1). Because the conventional B-BAController (9) stands also for its minimum form, the experiments

have been carried out only for two controllers applied in the local control loop as the controller C2: the B-BAController (9) and the conventional PI controller.

The unknown parameter for the simplified model (8) and consequently for the B-BAController (9) has been chosen as  $k_U = 1$ . This parameter represents the average gain of the system and if it is to be kept constant, its choice must be done arbitrary and somehow randomly because there is no a priori information on that value. Fortunately, again, due to the compensating properties of the estimation procedure, the B-BAController (9) is resistant to the uncertainty on this value. We practically have not noticed any significant influence of the value of the parameter  $k_U$  on the control performance. The tunings for the conventional PI controller are as follows:  $k_r = 7$  (proportional gain) and  $T_i = 1$  (integral time constant). The B-BAController has been tuned as  $\lambda = 7$ . This value ensured the good compromise between the aggressive control action and non-oscillatory control responses for possibly wide range of the set-point and of the disturbances changes. The increment of  $\lambda$  led to more oscillatory close-loop behaviour and, consequently, to instability. The value of the forgetting factor  $\alpha$  should be kept as small as possible so it was adjusted as  $\alpha = 0.1$  for the estimation procedure (2a) – (2c). The impact of the measurement noise was not very significant and thus it was possible to set the parameter  $\gamma = 1$ .

Figures 5 and 6 show the tracking properties of both controllers in the presence of the indicated step changes of the set-point  $Y_{F,sp}$ , which is important for the flow-based supervisory control strategy. These results prove that both controllers have been tuned quite aggressively. Two different gain regions have been considered. Figure 5 shows the case when only one of the pumps P1 is working. It results in the lower pressure in the system and, consequently, in the upper limitation of the accessible value of the controlled flow rate  $F$ . The results in Fig. 6 show the case when both pumps P1 are working and the higher pressure allows for the wider range of changes of the controlled variable  $F$ . Let us note that both controllers ensure fully comparable tracking properties for both examined regions of the system gain.

The results of the rejection of the disturbing step changes of the pressure for the constant set-point  $Y_{F,sp} = 1.5$  are presented in Fig. 7. These results are important for the temperature-based supervisory control. The disturbances have been introduced by the successive switching off and on of one of the pumps P1 at the indicated moments of time. Again, let us note that both controllers provide practically the same ability of the disturbances rejection.

Table 1 shows the values of the IAE and IADO corresponding to the experimental results presented in Figures 2 through 7. The lowest values are bolded and they illustrate the conclusive deductions presented above.

## 7. REMARKS ON THE PRACTICAL IMPLEMENTATION OF THE B-BAC METHODOLOGY

The final form of the B-BAC control law is quite simple, even if it is considered jointly with the RLS estimation procedure. Consequently, the computation complexity of the B-BAC methodology is rather low and thus the implementation is easy, even for not very experienced programmer. The B-BAC controllers, considered in this paper, have been implemented in the LabVIEW programming environment as the virtual controller [22]. However, it is surely possible to implement it on any PLC device accessible on the market with the application of the instruction list or of the ladder diagram, because the modern PLC's provide very fast operational speed and a large variety of arithmetic functions.

The estimation procedure (2a) – (2c) is a very important part of the B-BAC methodology. Due to its scalar form, the estimate  $\hat{R}_Y$  always converges to its true value but the dynamic properties of this convergence significantly influence the control performance of the accompanying control law. Thus, let us shortly discuss the most important difficulties resulting from the on-line estimation that we faced during practical experiments with the B-BAC methodology.

- The form of the estimation procedure is recursive so it requires the initial values of  $\hat{R}_{Y,0}$  and of  $P_0$ . The value of  $P_0$  is determined by the identification theory, which suggests adjusting it as a possibly large value and thus we decided to choose  $P_0 = 1000$ . As far as the initial value of  $\hat{R}_{Y,0}$  is concerned, let us note that it is always chosen randomly, because, in the practice, usually there is no a priori information on this value. We experimented with different values of  $\hat{R}_{Y,0}$  and with smaller values of  $P_0$  and it was found that, according to the theoretical considerations [10], they affect only the initial stage of the estimation run. Namely, the inaccurate choice of  $\hat{R}_{Y,0}$  results in the transient that always fades away and the estimate  $\hat{R}_Y$  converges to its true value  $R_Y$ . It takes place after a short period of time that depends only on the choice of the forgetting factor  $\alpha$  (smaller value of  $\alpha$  provides shorter transient time). In the practice, we experimentally confirmed the following procedure how to manage this difficulty without degrading

the control performance. One should adjust any reasonable value of  $\hat{R}_{Y,0}$  and start up the estimation procedure in the open loop. Then, after the transient (when the estimate has converged), the control loop with the B-BAController can be closed. The small value of  $\alpha$  additionally makes the transient shorter. This start-up procedure can be successfully applied to any open-loop stable systems. However, even if the system is open-loop unstable and there is no steady state, after the transient resulting from the inaccurate choice of the value of  $\hat{R}_{Y,0}$  the estimate starts to follow the variations of the true value of  $R_Y$  and thus the same procedure can be successfully applied. Therefore, in our opinion, in the practice the problem of the incorrect choice of the initial value of  $\hat{R}_{Y,0}$  is not very important for the final quality of the control performance.

- In the practical implementation, there is always a problem of the measurement noise, which influences the estimation accuracy and, consequently, the control performance. We confirmed experimentally that the larger value of the forgetting factor  $\alpha$  can decrease the influence of the measurement noise on the estimation accuracy but at the same time it degrades the dynamical properties of the estimation, which also degrades the control performance. Thus, we experienced that the best way to manage this problem is to keep the small value of  $\alpha$  (e.g.  $\alpha = 0.1$ ) and to apply the preliminary filtering instead. The first-order linear filters were found to be effective enough. Let us also note that the measurement noise influences the control performance not only by the estimation procedure but also by the signals included as the feedforward action directly in the control law and the suggested approach with additional filters allows also for filtering these signals.
- The impact of the measurement noise was different for each considered implementation. In the case of the control of the outlet temperature for the electric flow heater this impact appeared to be higher due to the fact that the measurement data of temperature was very noisy. Thus, by the experiments, we found that in this case there is a need to apply a very small value of the parameter  $\gamma$  for the estimation procedure (2a) – (2c), as it was suggested by Czczot [10]. We experimented with different values of  $\gamma < 1$  and the choice of  $\gamma = 0.03$  has been made by the trial and error method. The practical advice is to start the open-loop estimation with the small value of  $\gamma$  (e.g.  $\gamma = 0.01$ ) and to increase it gradually. The value of  $\gamma$ , for which the impact of the measurement noise in the estimate variations is acceptable, is the value that one is looking for. However, usually there is a need to re-tune this value in the closed loop because the B-BAController is very sensitive for the measurement noise.

As it was said, the tuning rules for the B-BAController are not specified and thus we had to apply the trial and error method. However, on the basis of the practical experiences, it is possible to give some suggestions to the user. The tuning parameter  $\lambda$  should be considered as the gain of the B-BAController. The procedure should start with the small value of  $\lambda$  (e.g.  $\lambda = 0.01$ ). Of course, if the closed loop response is too slow, the value of  $\lambda$  should be gradually increased and the experiment should be repeated. Let us note that the choice of the tuning parameter  $\lambda$  should be made for possibly wide variations of the disturbances and of the set point value due to the potential nonlinearity of the process.

In fact, The B-BAController has three tuning parameters: the forgetting factor  $\alpha$  and the parameter  $\gamma$  for the estimation procedure (2a) – (2b) and the gain  $\lambda$  for the control law itself. Of course, every tuning parameter influences the control performance and the practical experiments confirmed that there is an interaction between them. However, our experiences lead to the following tuning procedure. First, the estimation procedure should be tuned in the open loop. We strongly suggest adjusting the value of the forgetting factor  $\alpha$  possibly small ( $\alpha = 0.1$ ) and to experiment with the tunings of the filters and with the value of the parameter  $\gamma$  according to the procedure described above. Of course, the tuning of the estimation procedure should be carried out after the transient resulting from the incorrect choice of the initial value  $\hat{R}_{Y,0}$ . If the estimate converges and we accept the impact of the filtered measurement noise on the estimation accuracy, one can start the adjusting of the parameter  $\lambda$  in the closed loop. However, as it was said before, the tuning is the iterative procedure and thus it could be necessary to re-tune the estimation procedure in the closed loop. If such a necessity takes place, we rather strongly suggest keeping the small value of  $\alpha$  and to adjust the values of the filters tunings and of the parameter  $\gamma$ .

## 6. CONCLUSIONS

The results of the practical implementation of the B-BAC methodology show that it can be successfully applied in the practice. For both local control loops, even in the presence of the variations of the gain of the system, the controlled variable is always regulated at the set-point value due to the compensating properties of the on-line estimation procedure, without any preliminary off-line identification and without any integral action in the controller. In both cases, the dedicated B-BAControllers have been derived on the basis of the same simplified

and general form of the model (1). The successful application of the minimum form of the B-BAController for the control of the outlet temperature for electric flow heater shows that even in the case when there is no feedforward action in the final form of the control law, the B-BAC methodology ensures good control properties, without any steady state bias of the regulation error.

The experimental results show also that the application of the B-BAController for the considered local control loops provides the significant improvement of the control performance in the comparison with the conventional PI controller only for the application as the local controller C1 for the flow-based supervisory control of the heat distribution system. In this case, The B-BAController ensures better rejection of disturbances (the variations of the flow rate) forced by the supervisory control system. For the other considered cases, the application of the B-BAController does not improve the control properties of the local control loops. In our opinion, this result is very promising because the flow-based supervisory control of the heat distribution system is the strategy, which is surely the most effective and thus the most frequently applied in the practice.

From the implementation point of view, the simplicity of the B-BAC methodology ensures that it is very easy to explain and to understand at the level needed by industrial engineers. Moreover, the feed-forwarding is very easy because it results from the balance-based origin of the simplified model of a process. If some disturbing signals cannot be measured on-line, it is possible to rearrange the control law into its minimum form. It needs neither a dynamic black box model of the process nor the time consuming identification and model verification experiments. The integral action is not needed so the antiwind-up action is not necessary. The B-BAC methodology is very easy to implement, even if this implementation demands more computing power in comparison with the conventional PI controller. It is also easy to maintain. The most important disadvantage is surely lack of clearly defined tuning rules and working out these rules is surely the future challenge.

**Acknowledgements.** This work was supported by the Polish Ministry of Science and Higher Education.

## REFERENCES

- [1] M.A. Arbaoui, L. Vernières-Hassimi, D. Seguin, M.A. Abdelghani-Idrissi, Counter-current tubular heat exchanger: Modeling and adaptive predictive functional control, *Applied Thermal Engineering* 27 (2007) 2332-2338.
- [2] G. Bastin., D. Dochain, *On-line estimation and adaptive control of bioreactors*, Elsevier Science Publishers B.V., 1990.
- [3] B.W. Bequette, Nonlinear Control of Chemical Processes: A Review, *Ind. Eng. Chem. Res.* 30 (1991) 1391-1413.
- [4] D.S. Bernstein, J. Apkarian, Experiments for control research. Introduction to the special edition, *IEEE Control Systems Magazine* (2003) 10 – 13.
- [5] C.B. Chiou, C.H. Chiou, C.M. Chu, S.M. Lin, The application of fuzzy control on energy saving for multi-unit room air-conditioners, *Applied Thermal Engineering* 29 (2009) 310-316.
- [6] J. Czczot, The application of the substrate consumption rate to the monitoring and control of the biological processes of water purification, Ph. D. Thesis, Technical University of Silesia, Gliwice, Poland (1997) (in polish).
- [7] J. Czczot, Balance-Based Adaptive Control of the Heat Exchange Process. in: Proc. 7<sup>th</sup> IEEE International Conference on Methods and Models in Automation and Robotics MMAR, Międzyzdroje, Poland, 2001, pp. 853-858.
- [8] J. Czczot, Robust Balance-Based Adaptive Control of the CSTR. in: Proc. 8<sup>th</sup> IEEE International Conference on Methods and Models in Automation and Robotics MMAR, Szczecin, Poland, 2002, pp. 327-332.
- [9] J. Czczot, Balance-Based Adaptive Control of the Electric Flow Heater. in: Proc. 16<sup>th</sup> IFAC World Congress, Prague, Czech Republic, 2005.
- [10] J. Czczot, Balance-Based Adaptive Control of a Neutralization Process, *International Journal of Control* 79(12) (2006) 1581-1600.
- [11] J. Czczot, Balance-Based Adaptive Control Methodology and its Application to the Nonlinear CSTR, *Chemical Eng. and Processing*, 45(5) (2006) 359-371.
- [12] J. Czczot, Modelling for the effective control of the electric flow heaters – Simulation validation. *Simulation Modelling Practice and Theory* 16 (2008) 429 – 444.
- [13] S. Dasgupta, Y. Shrivastava, G. Krenzer, Persistent excitation in bilinear systems. *IEEE Transactions on Automatic Control* 36 (1991) 305-313.
- [14] R.Z. Freire, G.H.C. Oliveira , N. Mendes, Predictive controllers for thermal comfort optimization and energy savings, *Energy and Buildings* 40 (2008) 1353-1365.
- [15] L. Hua, S.-K. Jeong, S.-S. You, Feedforward control of capacity and superheat for a variable speed refrigeration system, *Applied Thermal Engineering* 29 (2009) 1067-1074.
- [16] A. Isidori, *Nonlinear control systems*, Springer-Verlag, New York, 1989.
- [17] M. Jelali, An overview of control performance assessment technology and industrial applications, *Control Engineering Practice* 14 (2006) 441 – 466.
- [18] N.V. Joshi, P. Murugan, R.R. Rhinehart, Experimental Comparison of Control Strategies, *Control Engineering Practice* 5(7) (1997) 885-896.
- [19] A. Kayihan, F.J. Doyle III, Friction compensation for a process control valve, *Control Engineering Practice* 8 (2000) 799-812.
- [20] P. Laszczyk, Hybrid SCADA system with embedded programmable controllers. in: Proc. Programmable Devices and Systems PDS (ed. Ciazynski, Hryniewicz and Klosowski) IFAC Publications, Elsevier, Science Ltd., 2001, pp. 155-159.
- [21] M. Metzger, P. Laszczyk, K. Pasek, Industrial-scale heat distribution pilot plant. In: *Institute of Automatic Control – Activity Report 1995-1996*, Edition I&D Gebka, Gliwice, 1997, pp. 32-36.
- [22] M. Metzger, Modelling, simulation and control of continuous processes, Edition of Jacek Skalmierski Computer Studio, Gliwice, Poland, 2000.
- [23] Z.K. Nagy, B. Mahn, R. Franke, F. Allgower, Evaluation study of an efficient output feedback nonlinear model predictive control for temperature tracking in an industrial batch reactor, *Control Engineering Practice*, 15 (2007) 839 – 850.
- [24] G. Özkan, H. Hapoglu, M. Albaz, Non-linear generalised predictive control of a jacketed well mixed tank as applied to a batch process – A polymerisation reaction, *Applied Thermal Engineering* 26 (2006) 720-726.
- [25] V. Paruchuri, R.R. Rhinehart, Experimental demonstration of nonlinear model-based control of a heat exchanger. in: Proc. American Control Conference, Baltimore, 1994, paper FP14-5:20.
- [26] L. Peeters, J. Van der Veken, H. Hens, L. Helsen, W. D’haeseleer, Control of heating systems in residential buildings: Current practice, *Energy and Buildings* 40 (2008) 1446-1455.



- [27] D.R. Ramirez, E.F. Camacho, M.R. Arahal, Implementation of min-max MPC using hinging hyperplanes. Application to a heat exchanger, *Control Engineering Practice* 12 (2004) 1197 – 1205.
- [28] R.R. Rhinehart, J.B. Riggs, Process Control through Nonlinear Modeling, *Control*. 3(7) (1990) 86.
- [29] D.E. Seborg, A perspective on advanced strategies for process control, *ATP* 41 (11) (1999) 13–31.
- [30] H. Subawalla, V.P. Paruchuri, A. Gupta, H.G. Pandit, R.R. Rhinehart, Comparison of model-based and conventional control: a summary of experimental results, *Ind. Eng. Chem. Res.* 35 (1996) 3547-3559.
- [31] F. Xaumier, M.V. Le Lann, M. Cabassud, G. Casamatta, Experimental application of nonlinear model predictive control: temperature control of an industrial semi-batch pilot plant reactor, *Journal of Process Control* 12 (2002) 687 – 693.
- [32] A. Zavala-Rio, C.M. Astorga-Zaragoza, O. Hernández-González, Bounded positive control of double-pipe heat exchangers, *Control Engineering Practice* 17 (2009) 136-145.

ACCEPTED MANUSCRIPT

**FIGURES AND TABLES**

ACCEPTED MANUSCRIPT

a)

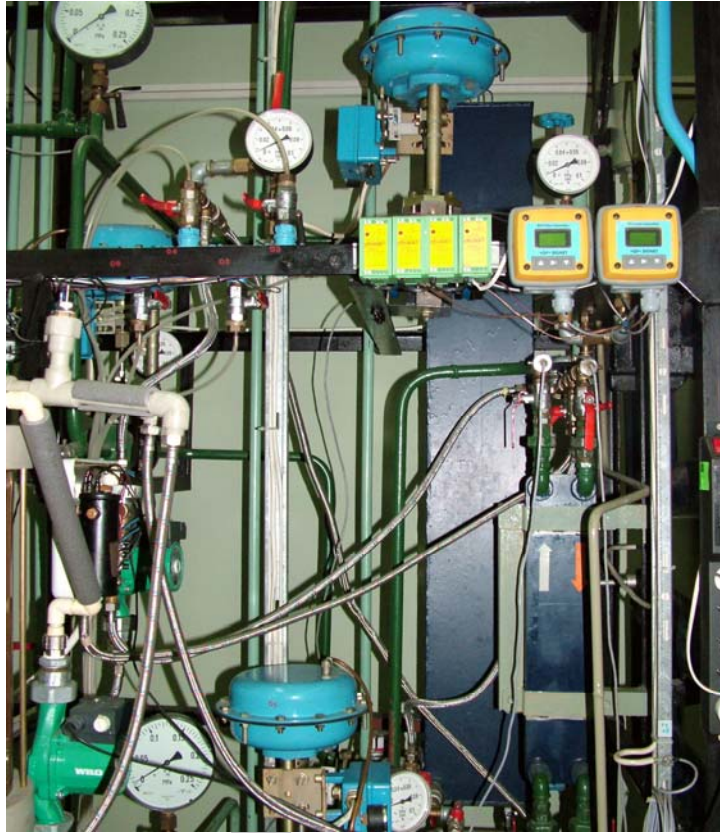

b)

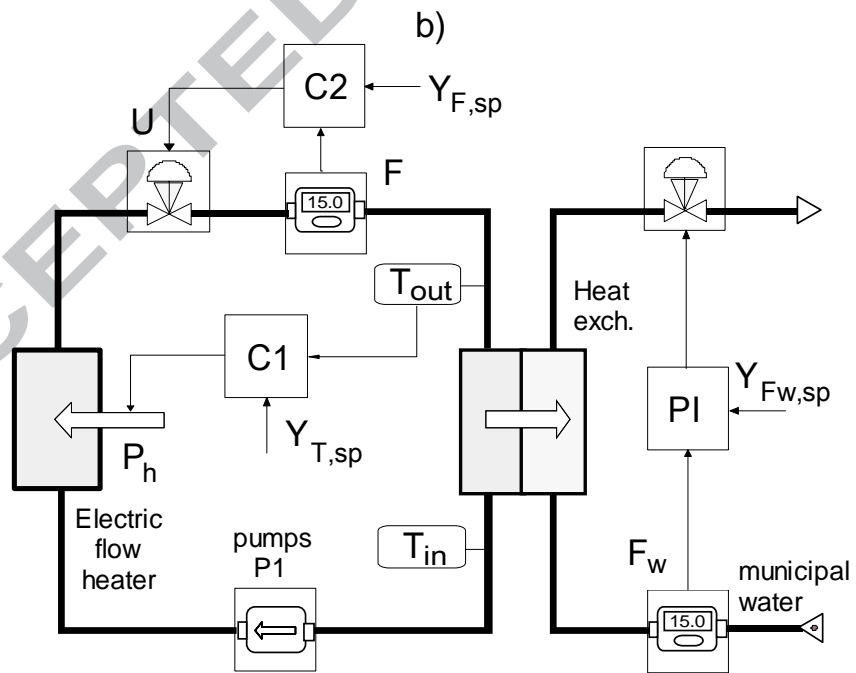

Fig. 1. Heat distribution plant, a) overview of the plant, b) simplified diagram.

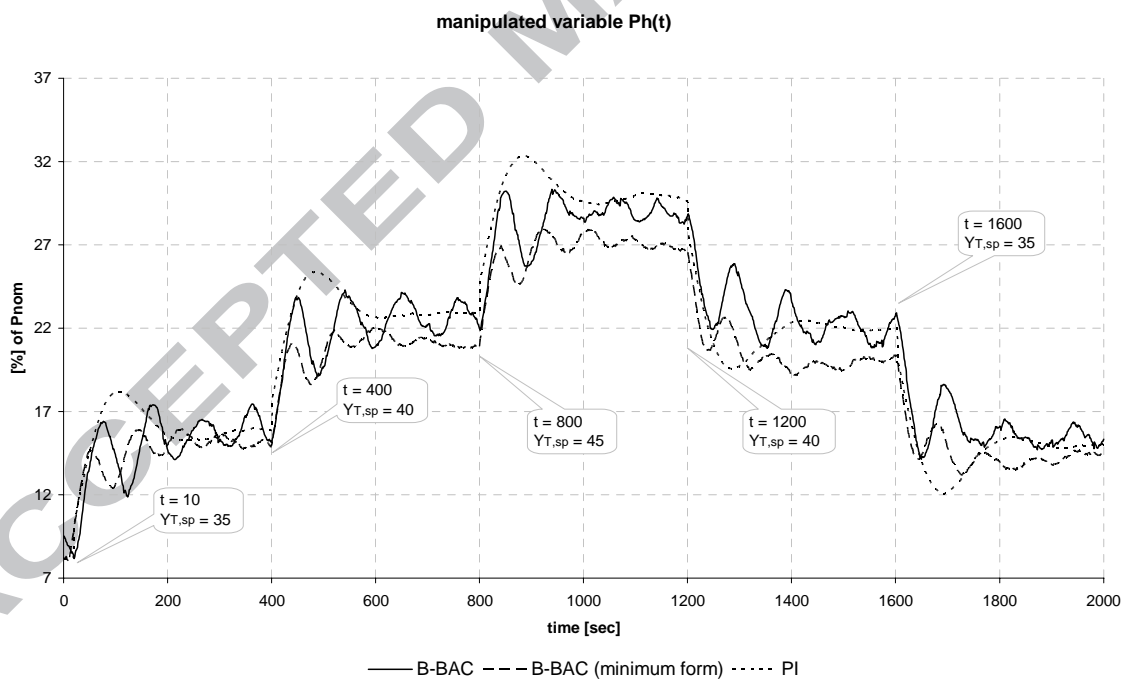
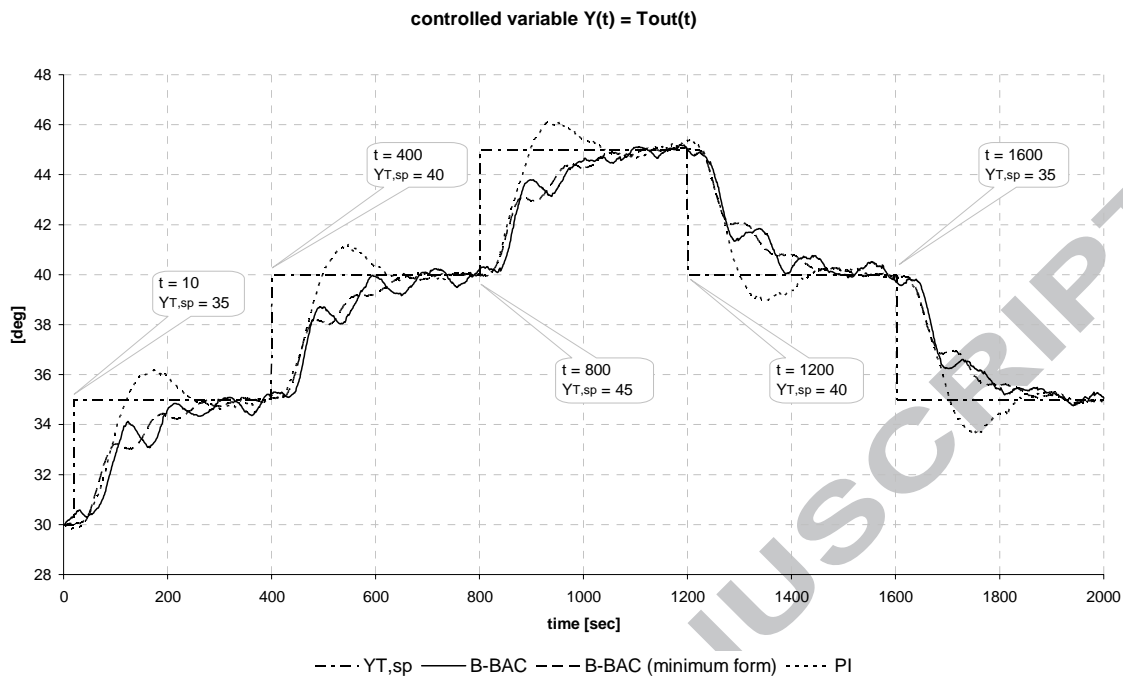

Fig. 2. Closed-loop responses for the electric flow heater with the flow rate  $F = 1$  [L/min] in the presence of the step changes of the set-point  $Y_{T,sp}$

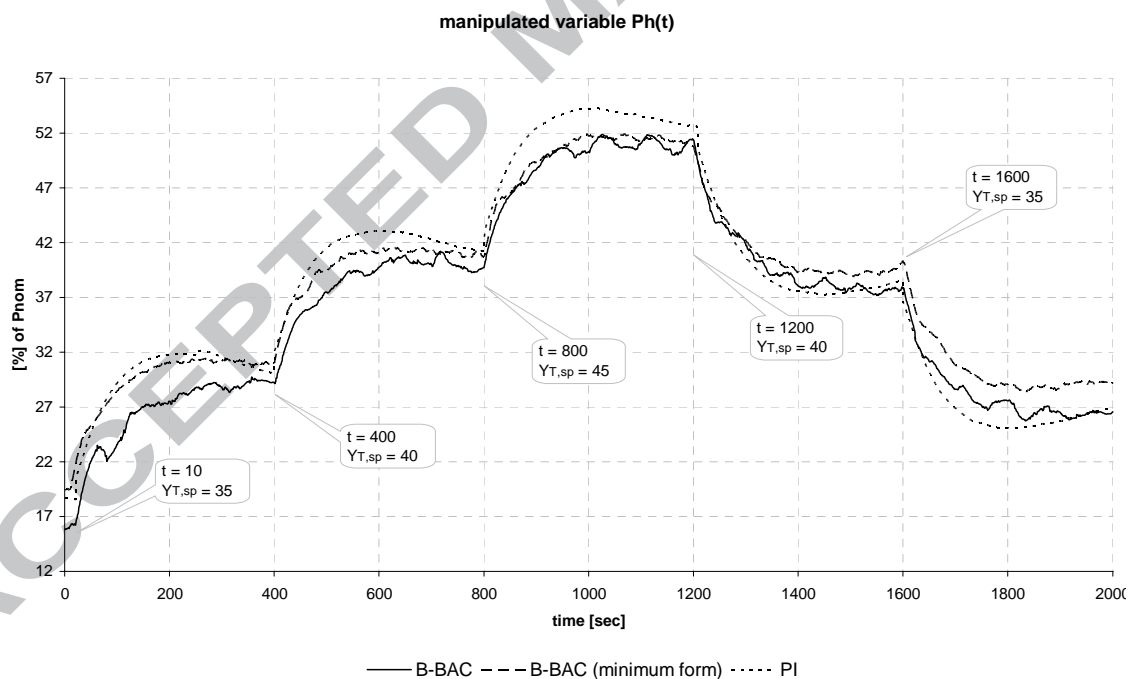
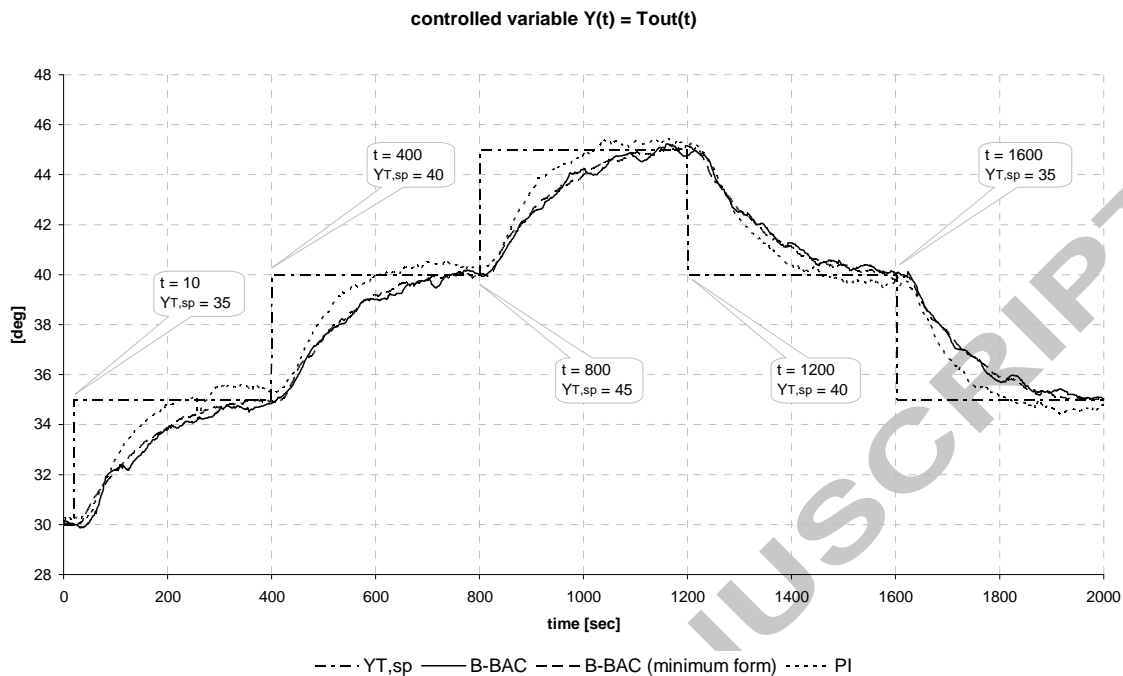

Fig. 3. Closed-loop responses for the electric flow heater with the flow rate  $F = 2$  [L/min] in the presence of the step changes of the set-point  $Y_{T,sp}$

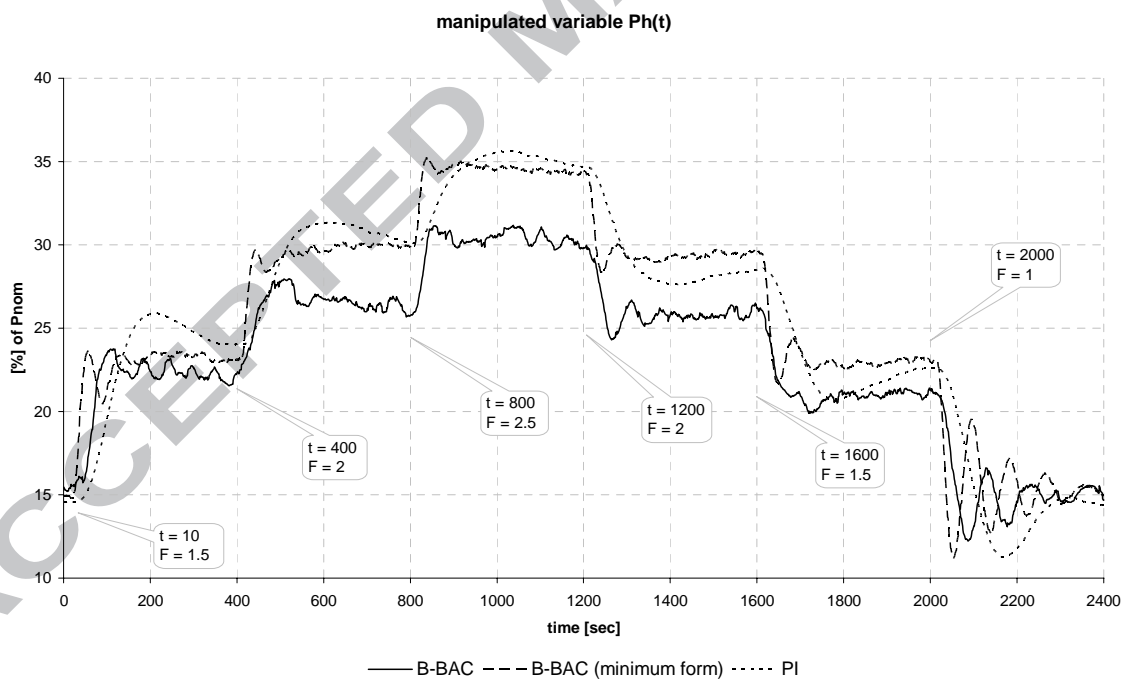
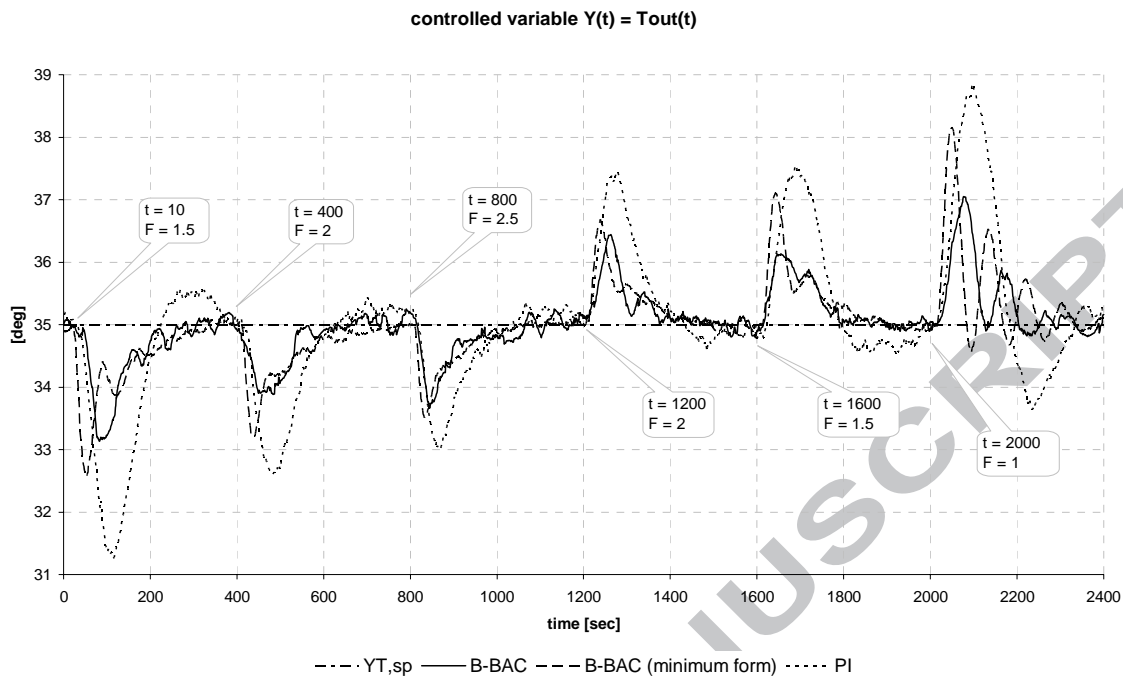

Fig. 4. Closed-loop responses for the electric flow heater in the presence of the step changes of the disturbing flow rate  $F$

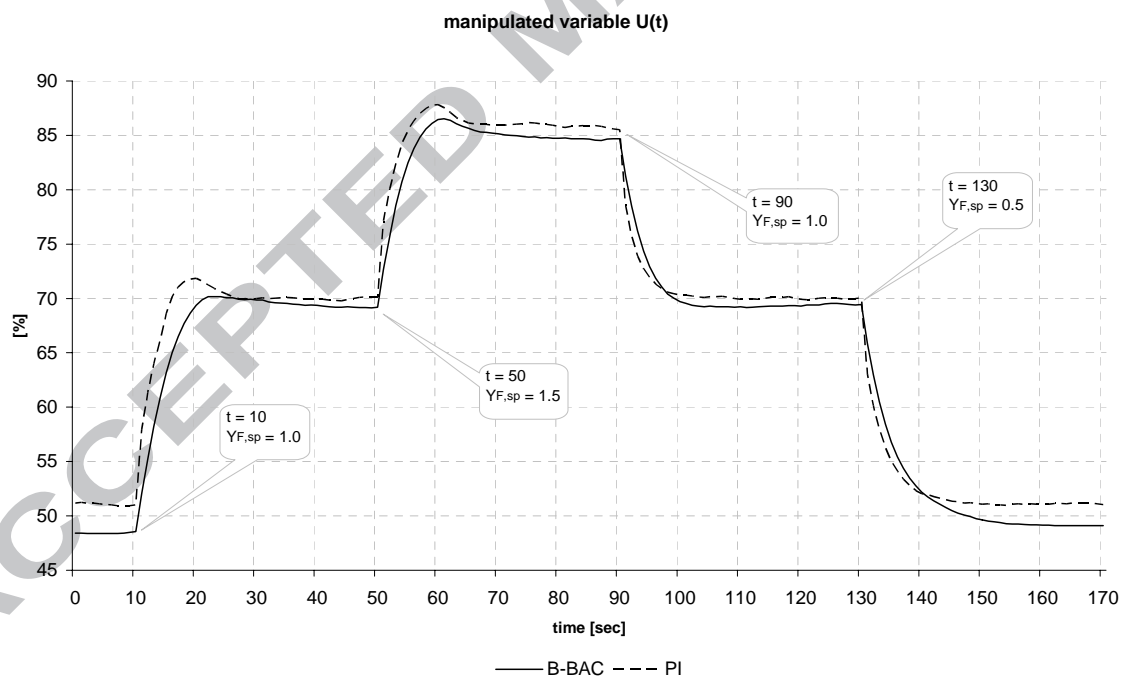
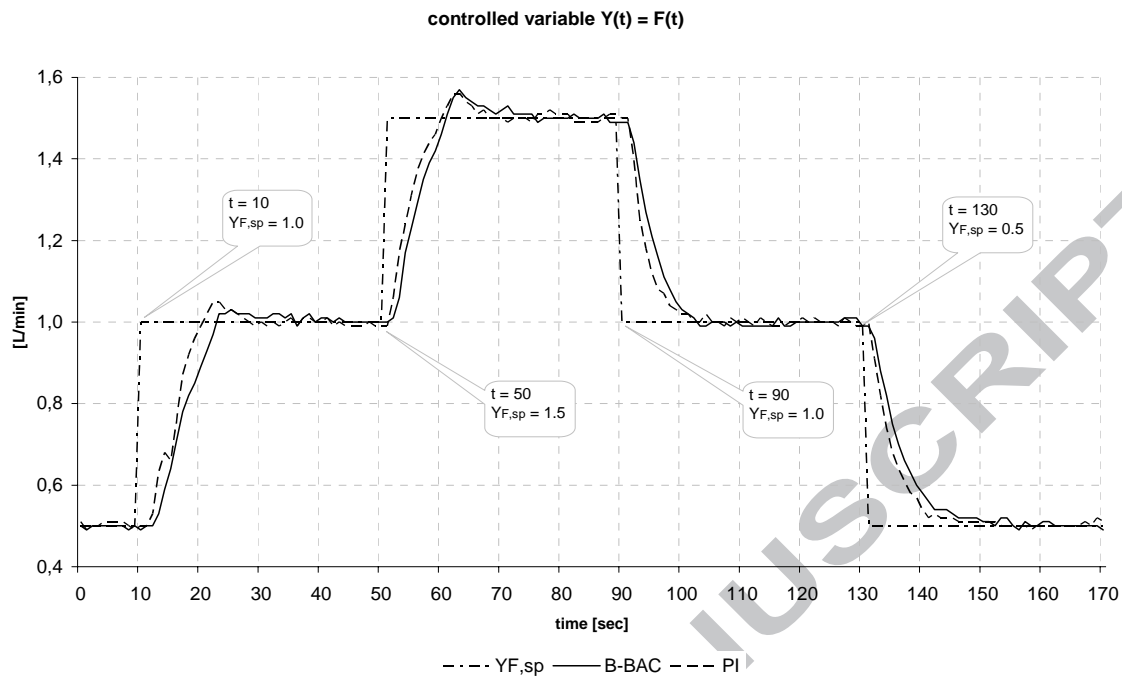

Fig. 5. Closed-loop responses for the control valve in the presence of the step changes of the set-point  $Y_{F,sp}$  – one of the pumps P1 is switched off

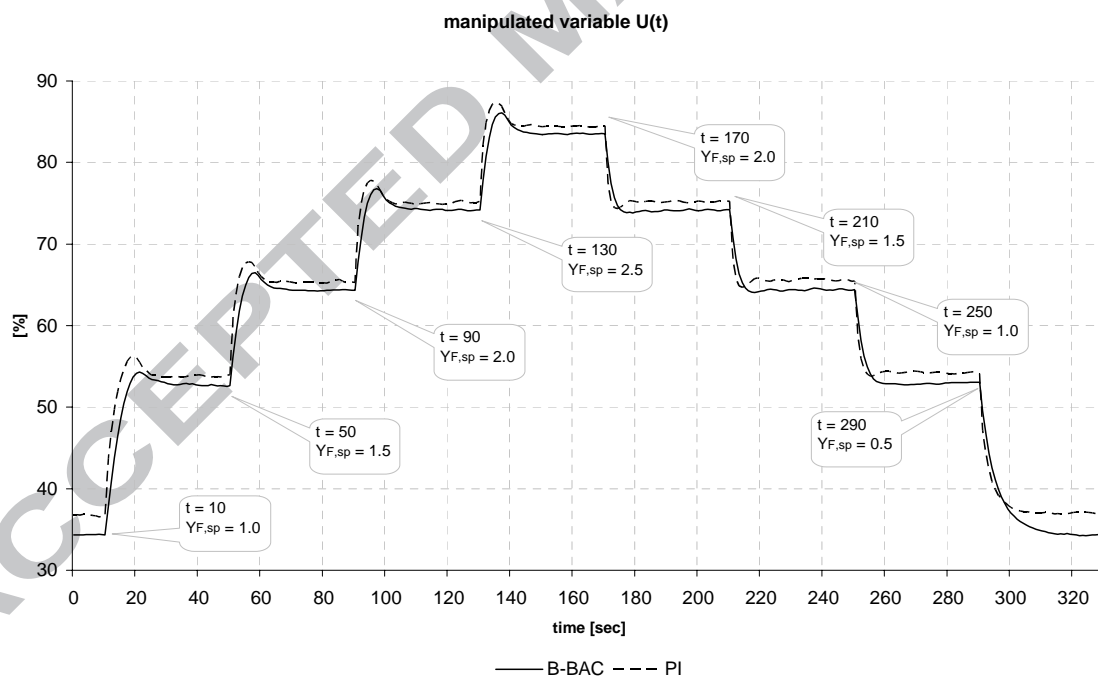
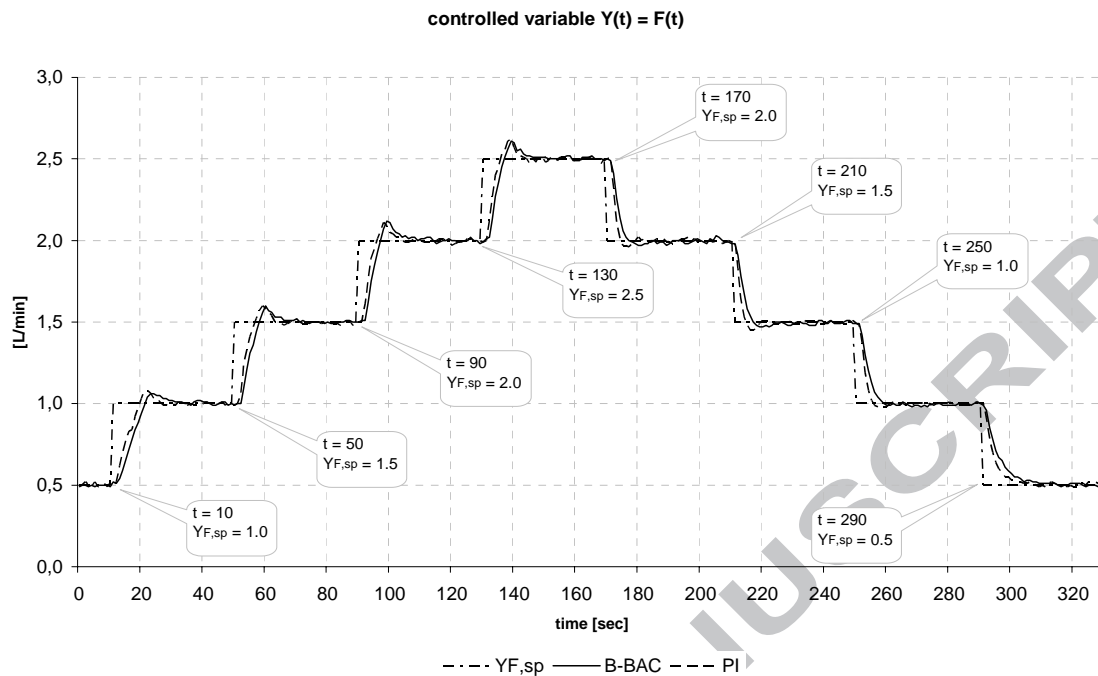

Fig. 6. Closed-loop responses for the control valve in the presence of the step changes of the set-point  $Y_{F,sp}$  – both pumps P1 are switched on



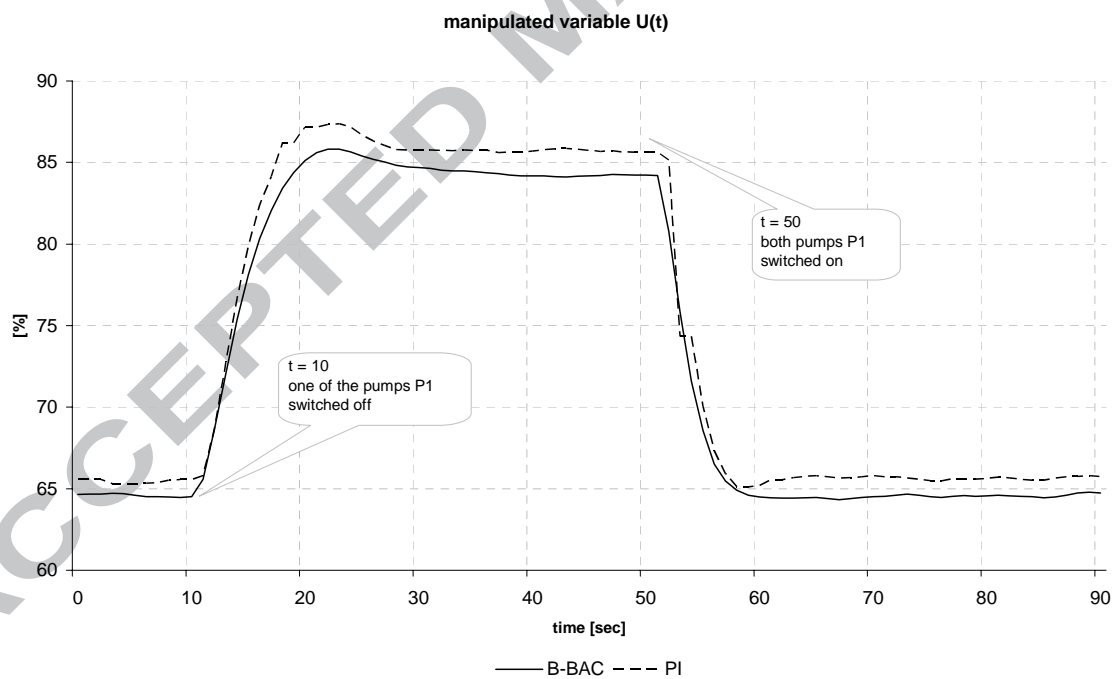
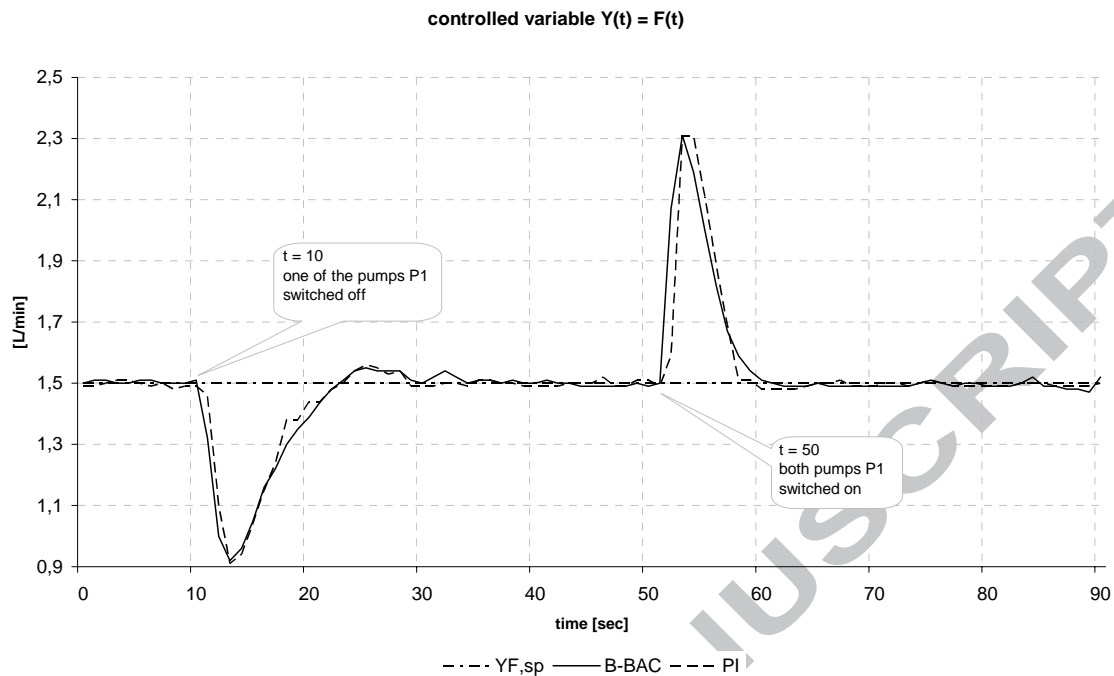

Fig. 7. Closed-loop responses for the control valve in the presence of the step changes of the supplying pressure

results presented in:	controller	IAE	IADO
Fig. 2	conventional B-BAController (5)	2640	172
	minimum for of the B-BAController (7)	2500	127
	conventional PI controller	<b>2140</b>	<b>73.5</b>
Fig. 3	conventional B-BAController (5)	3220	136
	minimum for of the B-BAController (7)	3050	125
	conventional PI controller	<b>2490</b>	<b>81.8</b>
Fig. 4	conventional B-BAController (5)	<b>836</b>	153
	minimum for of the B-BAController (7)	1010	163
	conventional PI controller	1960	<b>67.6</b>
Fig. 5	<i>B-BAController (9)</i>	13	<b>79.6</b>
	<i>conventional PI controller</i>	<b>10.6</b>	81.6
Fig. 6	<i>B-BAController (9)</i>	22	<b>126</b>
	<i>conventional PI controller</i>	<b>17.6</b>	134
Fig. 7	<i>B-BAController (9)</i>	7.36	<b>44.8</b>
	<i>conventional PI controller</i>	<b>6.69</b>	47.2

Table 1. IAE and IADO values for the experimental results