



HAL
open science

Ac breakdown in near-atmospheric pressure noble gases: I. Experiment

A Sobota, J H M Kanters, F Manders, M F Gendre, J Hendriks, E M van Veldhuizen,
M Haverlag

► To cite this version:

A Sobota, J H M Kanters, F Manders, M F Gendre, J Hendriks, et al.. Ac breakdown in near-atmospheric pressure noble gases: I. Experiment. *Journal of Physics D: Applied Physics*, 2011, 44 (22), pp.224002. <10.1088/0022-3727/44/22/224002>. <hal-00620589>

HAL Id: hal-00620589

<https://hal.science/hal-00620589v1>

Submitted on 8 Sep 2011

HAL is a multi-disciplinary open access archive for the deposit and dissemination of scientific research documents, whether they are published or not. The documents may come from teaching and research institutions in France or abroad, or from public or private research centers.

L'archive ouverte pluridisciplinaire **HAL**, est destinée au dépôt et à la diffusion de documents scientifiques de niveau recherche, publiés ou non, émanant des établissements d'enseignement et de recherche français ou étrangers, des laboratoires publics ou privés.



HAL Authorization

AC breakdown in near-atmospheric pressure noble gasses: I. Experiment

A Sobota¹, J H M Kanters¹, F Manders², M F Gendre², J Hendriks², E M van Veldhuizen¹, M Haverlag^{1,2}

¹Eindhoven University of Technology, Department of Applied Physics, Postbus 513, 5600MB Eindhoven, The Netherlands

²Philips Lighting, LightLabs, Mathildelaan 1, 5600JM Eindhoven, The Netherlands

E-mail: a.sobota@tue.nl

Abstract.

AC-driven breakdown processes have been explored much less than the pulsed or DC breakdown, even though they have possible applications in industry. This paper focuses on the frequency range between 60 kHz and 1 MHz, at a pin-pin electrode geometry and gap lengths of 4 or 7 mm. The breakdown process was examined in argon and xenon at 0.3 and 0.7 bar. We used electrical and optical measurements to characterize the breakdown process, to observe the influence of frequency change and the effect of ignition enhancers - UV irradiation and radioactive material.

PACS numbers: 52.20.-j, 52.80.-s, 52.80.Dy, 52.80.Pi, 52.80.Tn, 52.80.+z

Submitted to: *J. Phys D.:Appl. Phys.*

1. Introduction

Electrical breakdown in gasses driven by high-frequency AC voltage is a broad domain of interest, connecting research topics originating from the need for fundamental knowledge in various industrial branches. To name a few, knowledge on partial discharges was used in production of circuit boards and similar systems based on high-power semiconductors [1]; the damage caused by surface discharges was the cause and the motivation for the research. Later, glow discharges created under atmospheric pressure using AC voltage found its use in material processing [2–4]. Also, both volume and surface AC discharges that occur in partial vacuum are of particular interest for aerospace insulating technology and power devices operating in space [5]. The lighting industry focuses on AC discharges in near-atmospheric pressure noble gasses with an admixture of mercury when trying to achieve two important goals: one, to design ignition concepts for high-frequency operated lamps [6], and two, to lower the ignition voltage of lamps [7].

There are clear distinctions between different frequency ranges; in low frequency and high enough voltage, breakdown or partial discharges occur in every voltage cycle.

Increasing the frequency for the same pressure, gas type and gap length causes the discharge to take more than one cycle to form. The breakdown processes in high frequencies, in our case any frequency above 10 kHz, can again be divided into several classes; the combination of frequency, gap length and pressure for a single gas defines the relative significance of different effects in the whole breakdown process. For example, for low enough frequency and short enough gap, electron losses are significant and drift-related; increase of frequency or gap length causes less drift-related losses and a slow transition into a mode where electron losses are diffusion driven. As a consequence, on the lower end of the high-frequency range, heavy particles play a more important role than on the high end.

The AC breakdown process at frequencies covering three orders of magnitude between 100 kHz and 100 MHz was described in [8] mostly for low pressures and with the accent on frequencies above 1 MHz. One of the most evident effects of using high-frequency AC instead of pulsed or DC voltage is that the high-frequency AC breakdown requires as much as 50% lower voltage. The explanation offered involves accumulation of the heavy charge in the gap between the electrodes, due to their inability to drift and be lost as current in one half of a voltage cycle. It was proposed that the accumulation of the charge leads to field distortion in the gap and to lowering of the threshold voltage needed for breakdown below the pulsed value. Further increase in frequency, according to [8], complicates the mechanism further due to the lowering of the amplitude of the oscillations of electrons in the electrode gap. The work of Hale [9] in very low pressures and at frequencies above 5 MHz is mentioned in particular for his theory that the breakdown occurs when the electric field and the frequency are such that an electron acquires the ionizing energy at the end of one mean free path length. His calculations described the experimental results in very low pressures quite accurately.

Later observations of the lowering of the threshold voltage when switching to high-frequency AC voltage [1–7], and also as the frequency was increased, brought on again the same theories and possible explanations afore proposed by Meek and Craggs [8]. For high frequencies it was argued that the electron drift losses were lowered, which caused a more favourable ratio between electron production and loss [2,4]. As an alternative, in the lower frequency range between 50 and 200 kHz described in [5], the increased charge production and resulting lower threshold voltage was explained by the accumulation of heavy charges in the electrode gap, which in turn create a field distortion and trigger a streamer-like discharge formation.

In this paper, we present the breakdown process in the 100 kHz frequency range. Our aim is to examine features of AC-driven discharge in noble gasses. To that end, we used HID (High Intensity Discharge) lamp geometry filled with 300 or 700 mbar argon or xenon, with electrode distance at 4 or 7 mm. There are two reasons why we used standard HID burners for our experiments: one, because this approach eliminates the need for a vacuum chamber and allows for testing on more than one lamp per type, and two, because this research is of particular interest to the lighting technology. We used sine voltage of linearly increasing amplitude, in the frequency range between 60 kHz

and 1 MHz.

We show that for our particular combination of frequencies, gasses, pressures and gap lengths, neither of the two hypotheses aforementioned in the literature can fully explain the effects we observed. The gap length we used is too small for arguing that the electron losses are not drift-dominated, and by means of modelling presented in the accompanying paper [10] we found that the heavy charge accumulated near electrode tips over several voltage cycles during the formation of the discharge doesn't have high enough density to cause local field distortion that could modify the field already present at the electrode tips. We offer experimental data as well as discussion on the observed effects.

2. Experimental arrangement

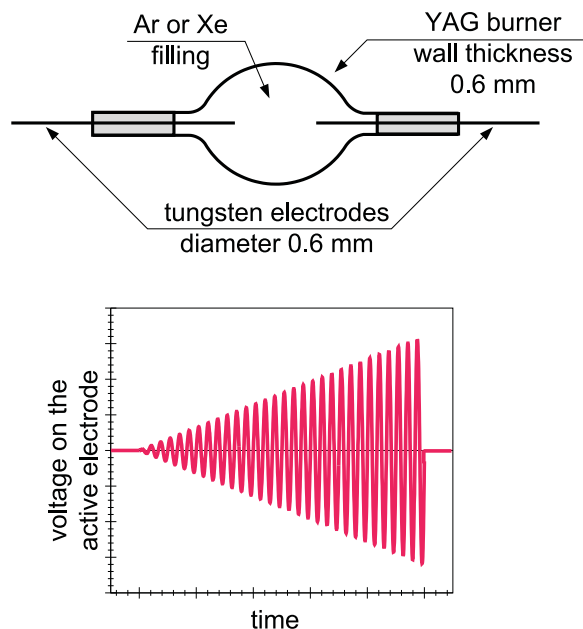

Figure 1. The schematics of the lamp burner is shown on top, while the shape of the voltage form we used for the experiments is shown below. We used a standard Philips 70W HID burner made of YAG, filled with argon or xenon and equipped with two simple rod-shaped tungsten electrodes.

We adapted the experimental setup used by Beckers et al and described in [7]. The experiments were performed on HID lamps filled with near-atmospheric pressure noble gas. The schematics of the lamps can be seen in figure 1. The geometry we chose was one of the Philips 70W HID burner as used in metal-halide lamps made of YAG (Yttrium Aluminium Garnet), the material chosen for its transparency and dielectric properties ($\epsilon_r = 11.7$). HID burners are usually made of PCA (Polycrystalline Aluminium), which is translucent and whose dielectric constant is similar to that of YAG. We used rod-shaped tungsten electrodes of diameter 0.6 mm. The electrodes were made by cutting or

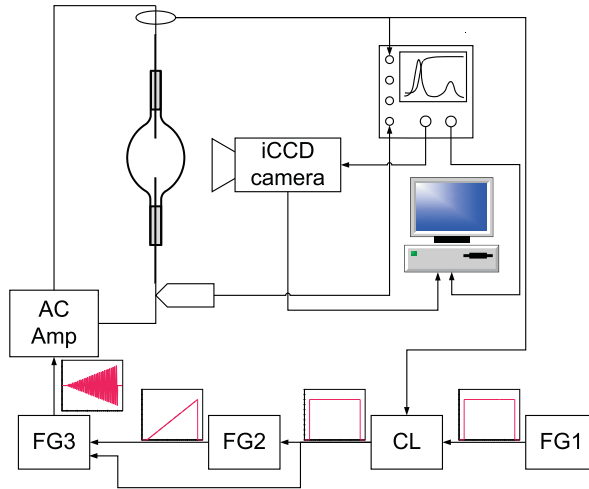

Figure 2. The experimental setup. ‘FG’ stands for ‘function generator’, ‘CL’ is the ‘current limiter’ and the ‘AC Amp’ is the AC amplifier. See the text for detailed explanation.

Table 1. The lamp types we used in the experiments. By ‘lamp type’ we denote a specific combination of gas, pressure, and the gap between the electrodes.

| Gas | Pressure [bar] | Electrode gap [mm] | number of available lamps |
|-----------------------|----------------|--------------------|---------------------------|
| Ar | 0.3 | 4 | 6 |
| | | 7 | 5 |
| | 0.7 | 4 | 3 |
| | | 7 | 5 |
| Xe | 0.3 | 4 | 3 |
| | | 7 | 2 |
| | 0.7 | 4 | 3 |
| | | 7 | 3 |
| Ar + ^{85}Kr | 0.3 | 4 | 3 |
| | | 7 | 3 |
| | 0.7 | 4 | 3 |
| | | 7 | 3 |

breaking a longer piece of tungsten wire, to get the $\pi/2$ angle at the edge. The electrode edges were did not receive any special treatment, they were not specially sharpened or blunted. The distance between the electrode tips was 4 or 7 mm. The volume of the lamp burners we used was $3.6 \times 10^{-7} \text{ m}^3$.

The lamps were positioned horizontally, suspended in air as far away possible from

metallic surfaces - the metallic optical rail and the UV lamp holder. The distance from the nearest metallic surface was about 15 cm.

The lamps were filled in noble gas atmosphere. We used Ar and Xe at 0.3 and 0.7 bar as filling gasses. We also had the opportunity to examine the influence of radioactive materials on the breakdown characteristics, and to this end we used 2.5 MBq/L of ^{85}Kr in a separate set of argon filled lamps. The ^{85}Kr contents was measured at atmospheric pressure. It is therefore necessary to scale it with pressure when making estimates for different lamps used in the experiments. One more advantage of using lamps for experiments is that we were able to experiment in more than one lamp per type (a 'type' is a particular combination of gas, pressure and the gap between the electrodes), thus reducing the possibility of the results being influenced by a bad set of electrodes, impurities or an error in the lamp filling procedure. Table 1 shows the list of lamp types we experimented on.

Some of the measurements were done with UV irradiation which completely flooded the test lamp. As the UV source we used a Philips TUV 4 W lamp, which produces a narrow line at 254 nm. The UV source was kept at 20 cm from the test lamp.

The AC signal we employed for the experiments was made using a combination of three function generators. Their respective roles are depicted in figure 2. The first function generator (FG) provided a pulse that was used both as trigger for FG 2 and FG 3 and to determine the duration of the sine signal coming from the third FG. The second function generator gave a linearly increasing signal, whose slope could be changed; this signal was used by FG 3 to modulate a sine signal of the desired frequency. The resulting AC signal was a sine of linearly rising amplitude, as pictured in figure 1. The experiments were performed in the frequency range between 60 kHz and 1 MHz, and the amplitude (peak) slope was varied between 10 and 1280 V/ms.

For amplifying the AC signal, we used two AC amplifiers, depending on the frequency range. The first one (Spitzenberger power amplifier Viechtach EV 600/C u.G) was used from 60 kHz to 200 kHz, and from 200 kHz to 1 MHz we used the AR Worldwide 800A3 AC amplifier with variable output impedance. We used a transformer coil after the AC amplifiers to additionally increase the voltage. Two different coils were used in the experiments, one for measurements performed between 60 and 600 kHz and the other one from 500 kHz to 1 MHz. There was some overlap in measurements (500-600 kHz), which was used to validate the measurements done with different coils.

For electrical measurements, we used a Rogowski coil and a high voltage probe. As can be seen in figure 2, the output of the Rogowski coil was fed to a current limiter (CL). This is a device home made in Philips Lighting which is used to modify the signal as a function of the current detected at its input. It was fed the trigger signal provided from FG 1 and transmitted it further as long as the current detected at the input was below the given limit. When the current reached the given limit (i.e. when the breakdown occurred), the device stopped transmitting the signal from FG 1, effectively cutting off the power fed to the lamp. In this way we ensured that the lamps didn't burn for more than a few μs after the breakdown took place. Consequently, we never reached

thermionic emission stage. The experiment repetition frequency was 0.1 Hz, which was sufficiently low to ensure the same starting conditions for every new breakdown process, given that the lamps were filled with noble gas only (no salts or mercury) and that they were not allowed to burn. The average breakdown voltage did not change with further decrease of the experiment repetition frequency.

Breakdown voltages were measured for 11 frequencies between 60 kHz and 1 MHz, at slope of 100 V/ms. Unfortunately, we were not able to collect all the data for all the lamp types because of the limitations of the equipment we used. For example, we do not have the breakdown voltage measurements for unassisted breakdown in 0.7 bar xenon at frequencies above 500 kHz, because the voltage amplification system we used could not provide a sine voltage of linearly rising amplitude higher than 5 kV. By *unassisted breakdown* we wish to denote the breakdown processes which were not aided in any way, which means that we did not use UV or radioactive enhancers. Ten breakdown voltage measurements were performed for each lamp in table 1 and for each data point. The average values and the standard deviations were calculated for each lamp, and subsequently for each lamp type. The data points in the graphs represent the average values and the standard deviations for the corresponding lamp type.

For optical measurements we used two cameras. The first one, the Princeton Instruments PiMax:512RB with a 512x512 pixel CCD array, was used for the imaging of the 60 and 220 kHz discharges. The second one was the Princeton Instruments UNIGEN II filmless GEN III iCCD camera with a 1024x1024 pixel CCD array, which was used for the imaging of the 400 and 800 kHz discharges. The pictures were taken for the voltages with 320 V/ms amplitude slope. The camera was triggered by the voltage taken at the active electrode of the lamp. The *active electrode* was the one the voltage was brought to, in contrast with the other, grounded electrode. Gate widths were typically 100 ns for detailed discharge tracking and 1, 5 or 10 voltage cycles for more general observations. We performed the optical measurements only on UV-irradiated lamps because then we had lower jitter in the system, which was by and large caused by the lamps. However, even in these conditions it was often impossible to track the discharge development in 100 ns increments.

3. Results

In order to avoid any confusion, first we would like to explain the term *breakdown* as we use it in the text. The *breakdown process* is a set of gradual changes in the gas through a series of states, during which parts of the gas become ionized and a charged channel that bridges the gap between the electrode tips is formed. The breakdown process ends at the *breakdown moment*, which is a particular point in time when we can observe a voltage drop across the electrode gap, due to the sudden drop of resistivity of the highly ionized channel that formed between the electrode tips. *Breakdown voltage* is the voltage amplitude at the active electrode at the breakdown moment. The schematic representation of the breakdown moment as observed in our experiment is shown in

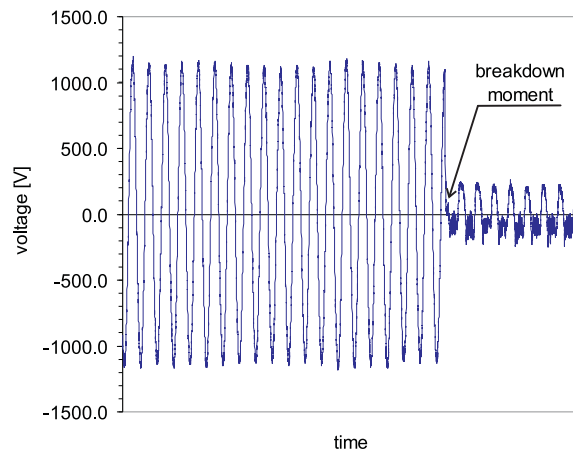

Figure 3. The potential of the active electrode around the time of the breakdown. There is a sharp amplitude drop at the breakdown moment. This profile was taken for a breakdown process at 1 MHz.

figure 3. In some places in the text the word *ignition* is used as a synonym for breakdown. The authors understand that in lighting research ignition is sometimes regarded as the event that encompasses breakdown, take-over and glow-to-arc transition, but we limit our research to the discharge development before and including the breakdown moment.

The voltage amplitude as shown in figure 3 appears to be constant, while we claim to have performed experiments with a linearly rising voltage amplitude slope. In fact, the amplitude is linearly rising in the experiments and we are always starting with initial amplitude of zero volts. However, the slope is slow, and the formative time of the discharge is very small compared to the slope, as is reported in the following subsection. The discharge formation happens only the very last part of the experiment. Consequently, the increase of voltage amplitude during the formation time does not exceed a few tens of volts, which amounts to a few percent of the voltage amplitude at the breakdown moment. This is why in figure 3 the voltage amplitude appears to be constant.

3.1. Gas type

Our goals for this research were to examine the influence of frequency change, UV irradiation and presence of radioactive materials on the breakdown parameters in two noble gasses often used in the lighting technology - argon and xenon. Qualitatively, the discharges in these gasses showed a very similar behaviour with respect to our main research parameters. However, as expected, we saw a clear influence of gas type on the measured breakdown voltage (bdV) and the duration of the breakdown process. The difference in the bdV can be seen in figure 4, which shows the results for the frequency range from 200 kHz to 1 MHz for 0.7 bar discharges. Comparison of the breakdown voltages of all UV-assisted ignitions we measured shows that the ratio of average values

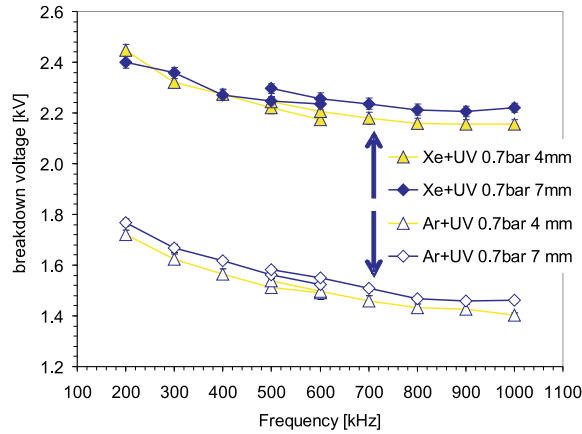

Figure 4. Breakdown voltages for 0.7 bar argon and xenon discharges, under UV irradiation. We can see the influence of the voltage frequency, but also the effect of the gas. The bars, however small, represent one sigma standard deviation from the mean value. Measurements were done using two transformer coils for passive amplification, one at 200 - 600 kHz and one at 500 kHz - 1 MHz. The overlapping measurements in the graph were performed in order to confirm that the values on the edges of the frequency ranges were correct.

of respective breakdown voltages in argon and xenon is fairly constant - it lies between 0.67 and 0.86 for 0.3 bar and between 0.71 and 0.76 for 0.7 bar discharges, across the whole frequency range (60 kHz - 1 MHz). This is 12.5% of deviation from the average for 0.3 bar and 4.3% for 0.7 bar discharges, across 1.5 orders of magnitude in frequency.

The difference in the duration of the breakdown process in Ar and Xe ranges from very small values for low frequency (60 kHz) to very large ones for the discharges at 800 kHz. At 60 kHz the difference in the duration of the breakdown process could not be observed, because the section of the breakdown process we were able to detect with the camera took part in 600 ns or less. Due to the time lags in the breakdown process, we were not able to reproduce the discharges in a way that would allow us to measure smaller differences in timing of the breakdown process. Therefore, we cannot claim to have seen any difference in the length of the breakdown processes at this frequency. However, we could observe differences between the breakdown in Ar and Xe in higher frequencies, the differences being more pronounced as we increased the frequency. At 800 kHz and 4 mm between the electrode tips, the differences in timing are still very small - the breakdown process in Ar and Xe takes 2 to 5 voltage cycles (1 cycle = 1.25 μ s at 800 kHz) for 0.3 bar and 8 ± 0.5 and 13 ± 0.5 voltage cycles for 0.7 bar Ar and Xe, respectively. However, at the larger electrode gap of 7 mm, the differences become more significant. At 0.3 bar, we measured the durations of the breakdown processes to be 17 ± 2.5 and 97 ± 5 voltage cycles for Ar and Xe, respectively. At 0.7 bar, the difference is just as large - 33.5 ± 5 compared to 145 ± 10 voltage cycles in argon and xenon, respectively.

3.2. Driving frequency

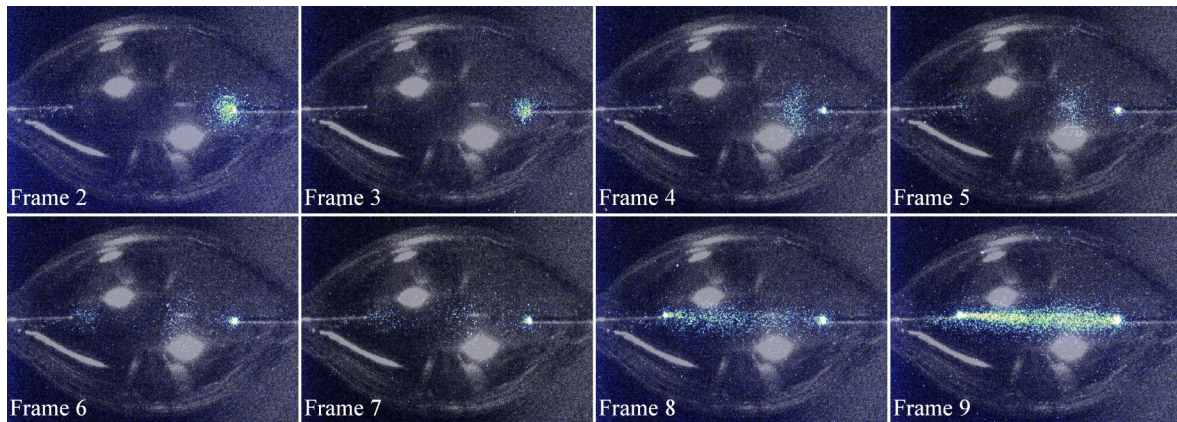

Figure 5. The development of a UV-aided 800 kHz argon discharge. The pressure was 0.3 bar and the electrode gap was 7 mm long. The gate width of the camera was 1 voltage cycle ($1.25 \mu\text{s}$). The positions of the individual frames with respect to the breakdown moment is shown in the next figure. The frames were not taken from the same discharge, as the equipment we used did not enable us to do so. For the sake of clarity, the picture of the lamp was added as an additional layer on top of the photographs of the discharge itself. In this way it is clear where exactly in the lamp does the breakdown process take place. The figure is presented in false colour.

Figure 5 shows the development of the discharge in argon, at 0.3 bar and at 800 kHz, under UV irradiation. Each frame was 1 voltage cycle ($1.25 \mu\text{s}$) long, and the individual frames were not taken during the same discharge event, due to the limitations of the equipment. We have made enough observations to be sure that the frame sequence we are showing here represents well the breakdown process under said parameters. The lamp itself, with marked electrodes, and the position of the frames with respect to the breakdown moment are shown in figure 6.

There are two important things to notice in these two figures. First, it is evident that the part of the discharge development that we were able to observe took about 15 cycles. This means that the total development time is 15 cycles or more. This is an important property of the AC discharges and a part of the reason why the high-frequency AC discharges can develop at lower voltages than the respective pulsed discharges.

The second important property is that the discharge does not appear streamer-like. The discharge is not even directed from one electrode to the other; it initiates at the electrode tips and it diffuses into the electrode gap between the subsequent voltage cycles. Eventually, the light is emitted from the whole electrode gap. We cannot speak of a channel that would appear to grow or propagate in a single direction from one electrode tip towards the other. However, one should bare in mind that our camera gate was 1 voltage cycle long during this investigation, which is a time 2-3 orders of magnitude larger than what a streamer takes to develop. It is, therefore, possible that there are streamers forming in the electrode gap, we just used a camera gate too long to

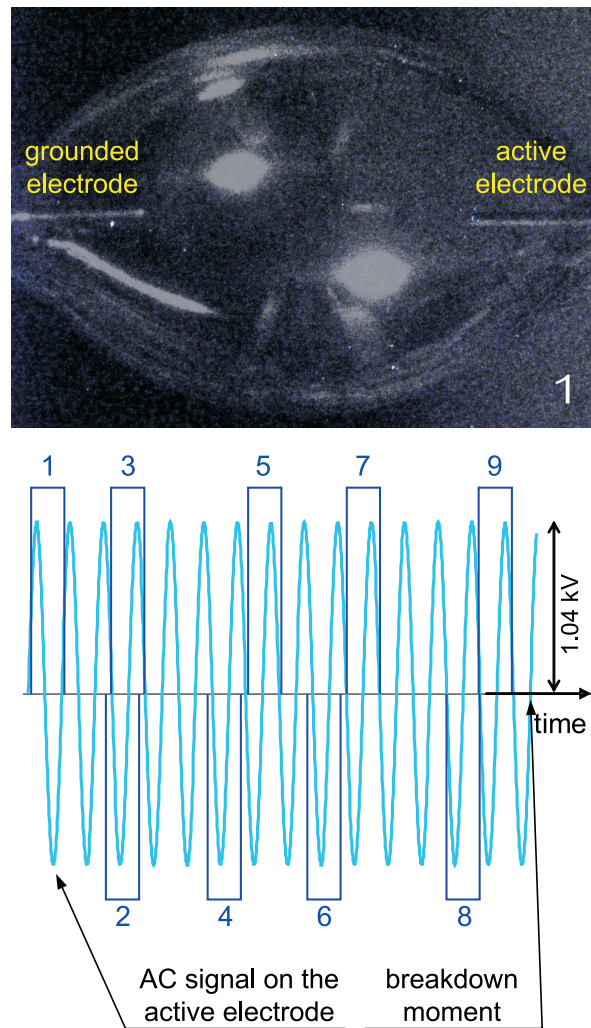

Figure 6. The enlarged photograph of a lamp is shown on the top, with the active and the grounded electrode clearly marked. Below, we show a schematic representation of the timing of the photographs in the previous figure with respect to the breakdown moment. The measurements were taken at 800 kHz, with camera gate width equal to one voltage cycle. It can be seen that at 800 kHz the breakdown process takes around 15 voltage cycles to develop.

see them. On the other hand, one expects an integrated photograph of many streamers that formed in a certain time interval to look much differently [11]. The pictures of the discharge development were taken on the irradiated lamps, with the slowly rising voltage amplitude slope. Both aspects mean that the amount of overvoltage is, if present, very small at time of breakdown, which could also have an effect on the appearance of the discharge.

Figure 7 shows a few frames in the breakdown process in the same gas and pressure, but at 60, 220 and 400 kHz. The photographs taken for the two lower frequencies are not of the same high quality as are the photographs taken at higher frequencies, but it is clear that the discharges at lower frequencies are less diffuse and their growth is

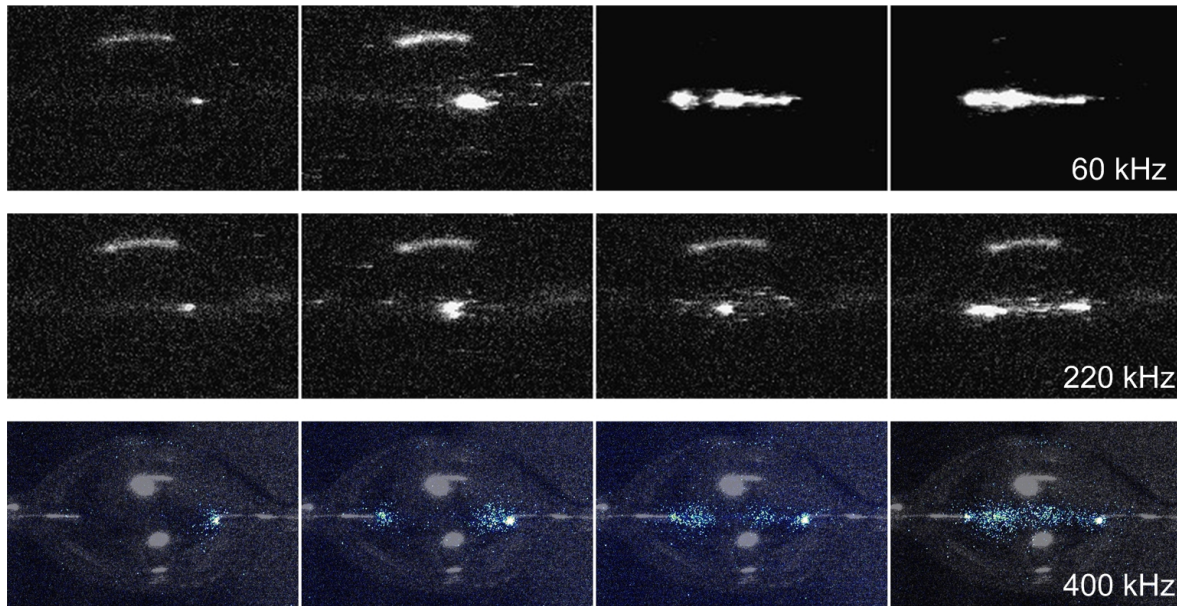

Figure 7. The highlights of the discharge formation in argon at 0.3 bar and at electrode gap of 7 mm, in 60, 220 and 400 kHz. The top two rows of photographs show the 60 and 220 kHz breakdown processes, and were taken with the older camera (the Princeton Instruments PiMax:512RB with a 512x512 pixel CCD array). The camera gate was 10 ns long. The second two photographs of the 60 kHz process were scaled in intensity in a different way than the first two, in order to show more details of the discharge growth. The thin stripe appearing at the top of the lamp burner is a reflection of the UV lamp, it has no connection to the breakdown process. The bottom row shows the 400 kHz breakdown process. For this frequency the photographs of the discharge process are overlaid with the image of the lamp, in order to have a clear idea about the growth process. The camera gate was 1 voltage cycle long ($2.5 \mu\text{s}$)

directed from one electrode tip to another.

As mentioned earlier, the visible part of the 60 kHz breakdown process took up to 600 ns, so the first row of photographs in figure 7 depicts the very last part of the very last voltage cycle before breakdown. In the 220 kHz case, the visible part of the breakdown process took one half of the voltage cycle, and this is shown in figure 7. At 400 kHz, the visible breakdown process takes about 4 voltage cycles ($10 \mu\text{s}$). The photographs in the last row in figure 7 show the breakdown process starting from $8.7 \mu\text{s}$ before breakdown in the first frame.

The time it takes the discharge to form in the lamp (i.e. the formative lag time) depends on the frequency, the gas type and the pressure. We documented the discharge development time for the part of the process that we could observe. From this set of data we can make a few general conclusions, the first one being that the breakdown process (at least the part that we could observe) becomes longer as the voltage frequency increases. This observation was made at the threshold breakdown voltage, which decreases with the increase in frequency. We have already mentioned that in 60 kHz breakdown events, the visible part of the breakdown process was up to 600 ns long, which took only a very

small portion of the very last voltage cycle before breakdown. In contrast, at 800 kHz the fastest discharges (Ar and Xe at 0.3 bar and 4 mm electrode gap) take 2 voltage cycles to develop ($2 \times 1.25 \mu\text{s}$), and the slowest one (Xe at 0.7 bar and 7 mm EA) takes as much as 145 ± 10 voltage cycles ($181.25 \pm 12.5 \mu\text{s}$).

We have also learned that the discharges in 0.7 bar always take longer to develop than the discharges in 0.3 bar. The aforementioned data supports this claim, and this result is not surprising - it has been known for a long time that the mean electron energy is lower in higher pressures, due to the higher electron-atom collision frequency. As a consequence, the discharges at high pressures will develop more slowly than the lower pressure discharges at the threshold voltage needed for breakdown.

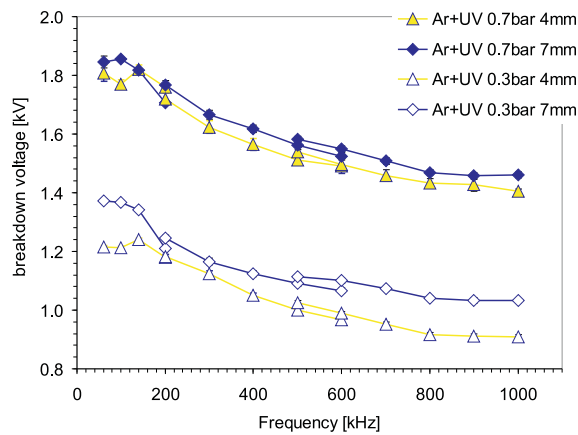

Figure 8. The figure shows the breakdown voltages for all argon lamp types over the whole frequency range. The breakdown process was aided by UV irradiation. The increase of the voltage frequency causes the lowering of the breakdown voltage.

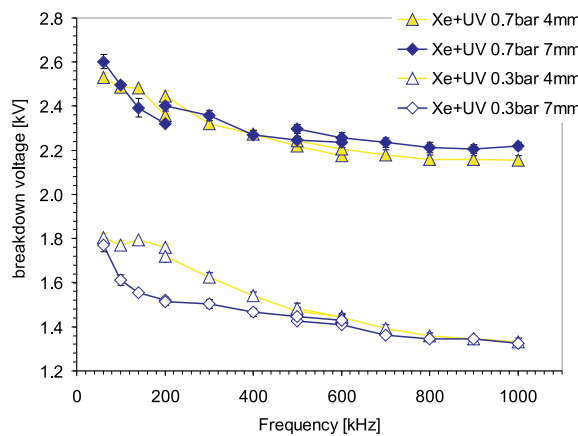

Figure 9. The figure shows the breakdown voltages for all xenon lamp types over the whole frequency range. The breakdown process was aided by UV irradiation. The increase of the voltage frequency causes the lowering of the breakdown voltage.

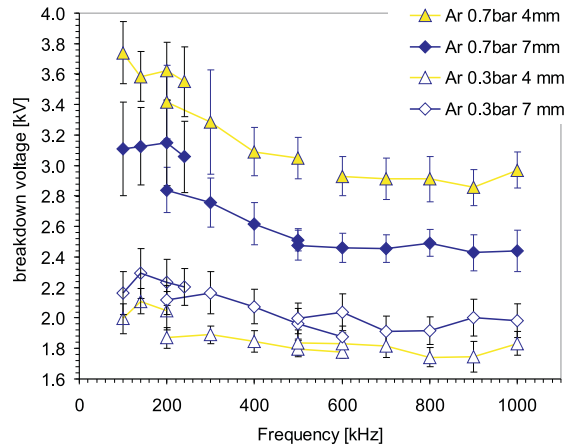

Figure 10. The figure shows the breakdown voltages for all argon lamp types over the whole frequency range. The breakdown process was unaided. Like in the UV-aided measurements, the increase of the voltage frequency causes the lowering of the breakdown voltage. This effect is present in all lamp types, regardless of the presence of UV irradiation or radioactive materials.

As a general rule, when we increased the frequency, the breakdown voltage decreased. This is shown in figures 8, 9 and 10, and it is true for both gasses, both pressures and both gap lengths between the electrodes. The change of breakdown voltage over the frequency range varied between 24.8% and 26.2% for 0.3 bar discharges. The lowering of the breakdown voltage for 0.7 bar discharges was 14.7% and 14.8% for Xe and 20.1% and 22.3% for Ar.

Since the measurements done without UV irradiation have large spread (see figure 10), the estimations for the change of breakdown voltage over the frequency range were done for the UV-assisted measurements only. The effect of UV irradiation will be shown next and discussed in the following section. It is important to notice that the drop of the breakdown voltage with the increase of voltage frequency is present in non-UV-assisted measurements as well. We have observed the same behaviour for all lamp types.

3.3. UV-related effects

The example of the breakdown voltages measured for 0.7 bar Xe shown in figure 11 demonstrates the two main consequences of the usage of UV irradiation during the breakdown process. The first effect is a significant lowering of the breakdown voltage, in this case by 43% to 53%. The second effect is a significant decrease in standard deviation in the measured breakdown voltages. In this figure, the decrease is as big as 80% to 90%. This drastic decrease points to the lowering of statistical lag of the breakdown process when using UV irradiation. Both effects are present at all frequencies and for all lamp types.

An additional effect can be seen in figures 10 and 11, and that is that for non-aided breakdown, the breakdown voltages for 7 mm electrode gap are almost always lower

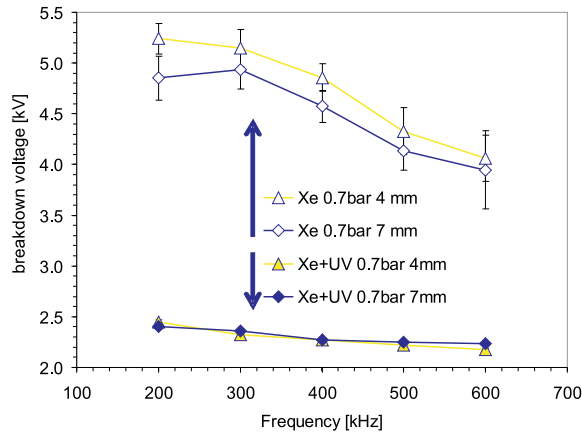

Figure 11. The breakdown voltages for the breakdown process in Xe at 0.7 bar. The effect of the UV irradiation is twofold: it reduces both the breakdown voltage and the standard deviation in the measured values. There is virtually no difference in the values for UV-assisted breakdown, mostly because the breakdown process is driven by the high electric field at the electrode tips, not in the lamp centre.

than for 4 mm electrode gap. This is a purely statistical effect. The lamps we use are very small and the probability of a free electron appearing in the electrode gap by means of cosmic radiation or similar is very low. In addition, this probability is almost twice as small for a 4 mm gap compared to a 7 mm gap. This is the source of the bigger statistical lag in 4 mm electrode gaps.

3.4. ^{85}Kr

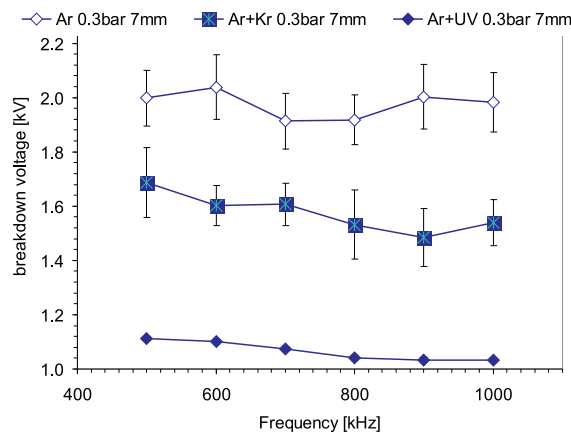

Figure 12. The comparison of the influence of ^{85}Kr and UV irradiation on the breakdown voltage in Ar at 0.3 bar, at 7 mm electrode gap. Even though ^{85}Kr is an unstable isotope and works as a direct source of electrons in our experiment, its influence is not as large as the influence of UV irradiation.

‘Ignition helpers’ are a popular addition to lamp systems because they ensure lower breakdown voltages and a higher probability of a successful breakdown event. While UV irradiation provides photons that help create free electrons by means of photoelectric effect, radioactive materials can also be chosen to directly produce electrons, which, depending on their energy, more or less successfully start electron avalanches. We used a common dosage of 2.5 MBq/L (or 67.5 μ Ci/L) of ^{85}Kr in Ar to probe the influence of radioactive materials. Figure 12 shows the relative influence of ^{85}Kr during the breakdown process in 0.3 bar Ar. Under these conditions, we measured breakdown voltages lowered by 16% to 27% with respect to the non-aided case. The most significant lowering of the breakdown voltage with the aid of ^{85}Kr was measured for the 0.7 bar discharge, and it was $38 \pm 9\%$. The ^{85}Kr dosage is measured at atmospheric pressure. This means that when filling the lamps with the noble gas, there will be 7/3 times more ^{85}Kr in the 0.7 bar lamps than in the 0.3 bar lamps. This is why ^{85}Kr has a bigger influence on breakdown voltage at the higher pressure.

Even though the radioactive material lowers the ignition voltage, it still doesn’t bring it down to UV-assisted level, as can be seen from the figure. The standard deviation of the breakdown voltage measurements also stays as large as for non-assisted measurements, suggesting that the statistical lag of the breakdown process is not significantly decreased.

4. Discussion

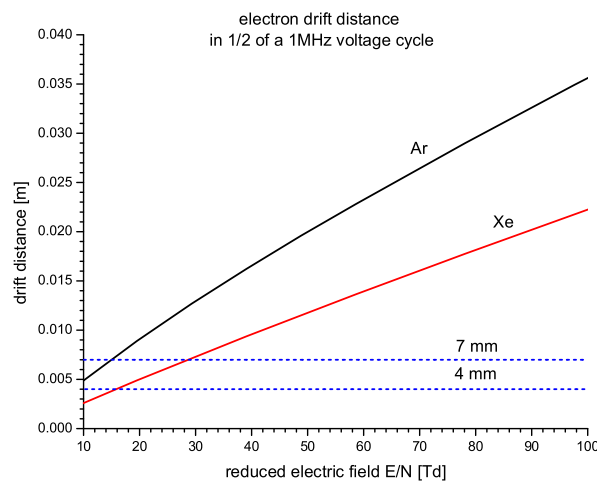

Figure 13. The drift distance of electrons in 1/2 of a 1 MHz voltage cycle in Ar and Xe in the reduced electric field range used in our experiments. The two horizontal lines represent the electrode gaps in the geometries we employed.

In this paper we presented the electrical and optical measurements that characterize the breakdown process in argon and xenon under high-frequency driving voltage. We have shown results that call attention to the influence of the driving frequency, the gas type and the two ignition helpers - UV irradiation and radioactive material.

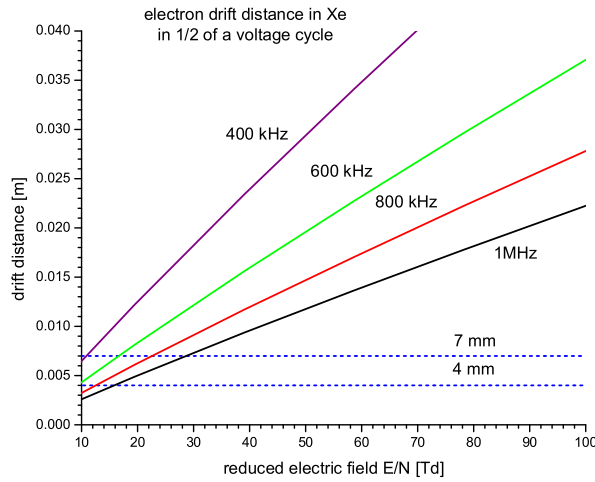

Figure 14. The drift distance of electrons in 1/2 of a 0.4, 0.6, 0.8 and 1 MHz voltage cycle in Xe in the reduced electric field range in our experiments.

In previous work concerning breakdown in the frequency ranging from 100 kHz to about 50 MHz [1–8], there were two ideas about which processes are important in discharge development and why AC breakdown is possible at lower voltages than for the pulsed breakdown. The first explanation concerns limited drift of electrons within the electrode gap between the electrodes at high enough frequencies, limiting drift losses and effectively increasing the ratio of electron source and sink in a single voltage cycle. When the frequency is not high enough, the second proposed solution is the accumulation of the heavy charges in the electrode gap, eventually creating local density high enough to modify the externally applied electric field and basically start a streamer-like process.

Figure 13 shows the electron drift distance over one half of a 1 MHz voltage cycle for argon and xenon, as a function of reduced electric field. The drift distance was calculated using a standard relation for the drift distance in an AC field, taking into account the sine shape of the electric field.

$$x = \frac{-qE_0}{m\omega\sqrt{\omega^2 + \nu_{col}^2}} \sin(\omega t) \quad (1)$$

q is the electron charge, m is the electron mass, ω is the angular frequency of oscillation of the electric field and ν_{col} is the electron-atom collision frequency. In our case, $\nu_{col} \gg \omega$, which means that we can write the afore mentioned expression as

$$\begin{aligned} x &= \frac{-qE_0}{m\omega\nu_{col}} \sin(\omega t) \\ &= \frac{-q(E_0/N)}{m\omega(\nu_{col}/N)} \sin(\omega t). \end{aligned} \quad (2)$$

We estimate the electric field strength by simply dividing the voltage across the electrodes with the length of the electrode gap $E = V/L$, which holds approximately only in the center of the lamp. The E/N range evaluated in this way is 20 - 80 Td in the center of the lamp. One should keep in mind that the E/N values at the electrode

tips are much larger than in the lamp center; the effect is that the drift distances in the graph are somewhat underestimated. In a symmetrical system such as ours, the electric field strength can be estimated as $E = V/(2R)$, where R is the radius of curvature of the electrode tip. Therefore, the average reduced electric field strength in the lamp is underestimated by factor $L/4R$, and by factor $L/2R$ at the electrode tips. Taking R to be equal to the electrode radius $R = 0.3$ mm, factor $L/4R$ equals 3.3 and 5.8 for 4 mm and 7 mm electrode gap, respectively. The two horizontal lines in figure 13 represent the two electrode gaps we used in the experiments - 4 and 7 mm.

It can be seen that the frequency range we used does not provide fast enough oscillations for our small electrode gaps (4 or 7 mm) to limit the electron drift losses, at least not for argon discharges. The electrons in xenon appear to have the drift distance comparable to the gap length at low E/N values, but as we mentioned already, the drift distances are underestimated. We cannot claim to have a transition to the breakdown mode where the electron drift losses are lowered by a significant amount. At higher frequencies we expect there to be a transition to this mode of operation, with further lowering of the breakdown voltage.

In the accompanying paper [10] we show by means of modelling that the local densities of accumulated heavy charge are not high enough during the time before the breakdown to modify the electric field imposed by the rod-shaped electrodes that we used in the experiments.

The aforementioned theories have a greater influence in other combinations of gas, pressure, voltage frequency and electrode gap than in our case. We would like to suggest that there are a few additional important aspects in the AC breakdown process that are not there in the pulsed breakdown case. The first one is that the discharge in high frequencies develops over several voltage cycles, as we have shown in figures 5, 6 and 7. This fact in itself suggests that the time allowed to the AC discharge to develop (10 to 50 ms in our case) is several orders of magnitude larger than the typical times associated with pulsed breakdown, in 10-100 ns order of magnitude. One typical result for pulsed breakdown is that the breakdown voltage decreases as the voltage ramp decreases [12, 13], which suggests a significant overvoltage during the pulsed breakdown process. The overvoltage occurs simply because the voltage rises too quickly (the pulses used are very narrow), and at typical discharge growth speeds of 10^5 to 10^6 m/s [11, 12], the discharge grows too slowly to fully form before a significant overvoltage occurs. In the case of AC breakdown, there is no significant overvoltage caused by the formation time because of the very slow ramp of the voltage amplitude.

There is another aspect of the AC ignition process that makes it very different from pulsed breakdown. The fact that the discharge develops in several cycles, while we still have large electron losses due to drift, suggests the relative importance of the heavy particles whose density does not strictly follow the AC signal. Here we are talking about atom metastables and molecular ions, that also form in relatively high densities, due to the high pressure (0.3 and 0.7 bar) we were working in. Unlike electrons, these particles do not drift and diffuse far away from the electrode tips (the places of highest particle

production) during a single voltage cycle. The metastables are electrically neutral, so they just diffuse away from the place they were produced at, but the molecular ions are charged and they drift back and forth from the electrode tips, thus making secondary electron emission from the electrode surface one very important aspect in which AC breakdown differs significantly from the pulsed ignition process. We suggest that this is one of the key reasons why the AC process requires much (up to 50% [7,8]) lower voltage for breakdown. The details are presented in the accompanying paper [10].

4.1. Breakdown process in argon and xenon

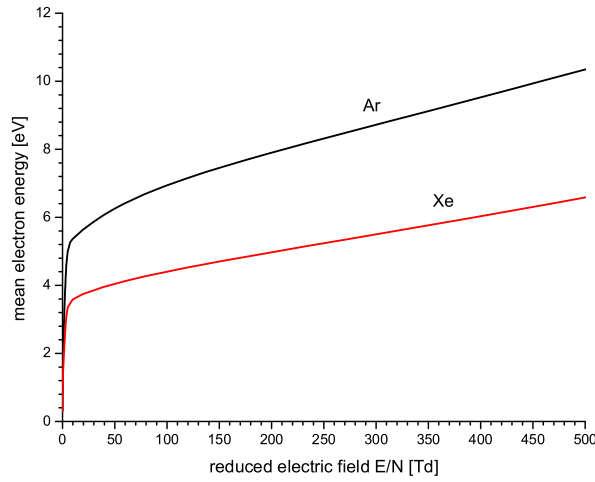

Figure 15. Mean electron energy as a function of reduced electric field for Ar and Xe. The values were calculated using Bolsig+ [14] and the cross sections collected by Phelps [15].

Table 2. Reactions in an AC breakdown process. In this case, X stands for Ar or Xe.

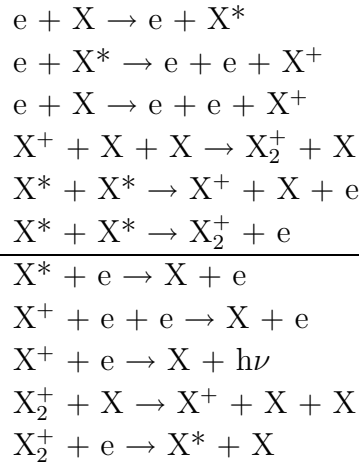

Table 3. Basic properties of argon and xenon.

| property | argon | xenon |
|------------------|----------|----------|
| atomic weight | 40 | 131.3 |
| radius | 71 pm | 108 pm |
| ionization level | 15.76 eV | 12.13 eV |
| lowest lying | 11.55 eV | 8.32 eV |
| metastable level | | |

Both argon and xenon are noble gases, which makes the chemistry during the breakdown process fairly simple, assuming pure gas environment - we have direct and stepwise ionization by electron collision, associative collisional ionization of metastables and three-body associative collisional process between atomic ion and neutral gas atoms. The reverse processes are also present, the most important being the associative recombination and collisional deexcitation of metastables (see table 2). The reactions given in table 2 represent a simple model including processes with most influence on the breakdown process in pure Ar or Xe. Additional reactions are also possible [16,17]. The important thing to notice is that there are two classes of reactions mentioned - the first one depending on the electron energy and density, and the second one depending on the density of the heavy particles. It is also important to realize that the heavy particles which take part in the second class of reactions are created in the reactions belonging to the first reaction class. It is a kind of a chain process, the beginning of which heavily depends on electron properties.

When we compare basic properties of argon and xenon as presented in table 3, we see that argon has a higher ionization potential and higher-lying metastable states, which makes it more difficult to ionize than xenon. Therefore, for the same conditions, an argon discharge should have a higher threshold voltage needed for breakdown than a xenon discharge. However, this is not the case, as we have shown in almost every figure in this paper. The explanation for this effect is of a fundamental nature, and does not bring new knowledge. However, it will also help us to explain other differences between argon and xenon.

It is true that for equal electron energies, xenon is easier to ionize than argon, but for the same reduced electric field, mean electron energies in argon and xenon are different. One basic property of an atom is its size, and we know that the xenon atom (radius 108 pm) is much larger than the argon atom (radius 71 pm), because it has two extra filled electron shells. As a consequence, the electron-atom elastic collision frequency is almost twice as large in xenon than in argon in our experimental conditions [18]. The electron-atom elastic collisions are important because they influence the electron energy and electron velocity distribution, which causes large differences during the breakdown process, the differences that cannot be explained by mere comparison of the ionization potentials.

The mean electron energies for the reduced electric field we had in our experiments is shown in figure 15. One can see that the mean electron energy of xenon is significantly lower than that of argon, for same E/N values; this is why xenon is harder to ionize at the same externally applied voltage.

The E/N range we show in the graph is quite large, and in fact wider than that which we expect in the experiment. However, one should not lose sight of the non-uniformity of the electric field in a pin-to-pin electrode geometry. The electric field governing the processes is the one at the electrode tip, not the one that can be easily estimated for the center of the electrode gap. Even though we used simple rod-shaped electrodes without sharp tips, we still expect the electric field to be significantly larger at the electrode tips than anywhere else in the lamp.

Since the electron energy can be more efficiently lost in xenon, this could be a possible explanation as to why the discharge formation in xenon takes so much longer than in argon. We know that the mean electron energy depends on the electron-atom collision frequency - the higher the frequency, the lower the mean electron energy. There are two ways for increasing the collision frequency, one of which is increasing the gas pressure, and the other to increase the atom size, because the elastic electron-atom collision frequency depends on the polarizability of the atom, and for noble gases this value scales with the volume of the atom. This suggests that the increase of atomic size has a similar effect as the increase of the pressure of the neutral gas. This is also something we have observed and described in the Results section - the 0.7 bar discharges take longer time to develop than 0.3 bar discharges, similar to the way the xenon discharges take a longer time to develop than argon discharges. The reason behind both these effects could be that lower mean electron energy means that more time is needed to build a charged channel between the electrodes.

Building on this explanation, it becomes clear why discharges in lighter noble gases are as a rule easier to ignite than the ones in the heavier gases. Also, introducing very small fractions of heavier noble gas in a lighter noble gas atmosphere results in even easier breakdown that requires even lower voltages. This is because the mean electron energy is determined by the atmosphere of the lighter noble gas, while the small fraction of the heavier noble gas is used for ionization purposes, due to its lower ionization potential. This has been shown numerically [17].

However, this is not the whole difference between the two gas types. One should not forget the differences in ionization potentials, metastable levels and reaction coefficients for the processes we have identified as important. Simulations taking all these phenomena into account are required to understand their joint effect on the breakdown process.

4.2. Influence of voltage frequency

In the Results section, we have shown in many figures that one effect is always present - the lowering of the breakdown voltage with the increase of frequency. This is a result

which is also in agreement with the data published by Beckers et al [7]. As we have shown already, this effect cannot be explained by the lowering of electron drift losses or by accumulation of heavy charge that modifies the local electric field. However, the explanation does lie in the heavy species present in the discharge. The explanation we are proposing is described in more detail in the accompanying paper [10], as it is a result of simulations. Here we offer only a short explanation.

The process which we believe is responsible for the decrease of the threshold voltage needed for breakdown when the frequency is increased is secondary electron emission from the electrode surface. There is only one important heavy species, molecular ions. The reason why the atomic ions do not play a significant role is that their density is very low, due to very efficient three-body associative collisional process with neutral atoms, in which molecular ions are created. The reason why the metastable species are not as important as the molecular ions is that they are not charged, so they don't drift back and forth around the electrode tip - they just diffuse away.

The molecular ions are created at the electrode tip around the time when the voltage is at its extreme. They then drift away until the polarity changes, at which point they start drifting back towards the electrode. When they reach the electrode, the secondary electron emission occurs with a certain probability.

While the molecular ions drift back and forth, their density decreases due to diffusion and recombination processes, and they return to the electrode surface in smaller numbers. If the frequency is increased, the fraction of the molecular ions that return to create secondary electrons is also increased. More secondary electrons means better effective ratio between the source and the sink of electrons during a single voltage cycle, which eases the breakdown process and allows it to take place at lower voltage. A more detailed set of results can be found in the accompanying paper [10].

4.3. UV-related effects

When estimating the effects of the voltage frequency on the breakdown process, we have used the breakdown voltage measurements for UV-assisted breakdown events, because the UV-assisted process gives rise to much smaller deviation from the mean value. In this way we were able to draw conclusions that cannot be dismissed due to large error bars of the non-assisted breakdown processes. We have also shown in several figures that the behaviour of the UV-assisted and non-UV-assisted measurements is the same over the whole frequency range, but to really claim that the same conclusions hold for both UV-assisted and non-assisted breakdown processes, we have to consider the impact of the UV irradiation.

One aspect is certainly photoemission of electrons from the surfaces within the lamp. The 254 nm (4.9 eV) UV photon that comes from the UV source used in the experiments can produce a photoelectron by means of photoelectric effect from the surface of the electrode made of tungsten ($W \approx 4.5$ eV). As such, the UV irradiation works as an effective electron source near the electrode surface, thus supplying the gas

volume with enough free electrons to minimize the statistical lag otherwise induced by the lack of initial free electrons [19]. This effect can indeed have a big influence on the availability of the free electrons in the gas at all times, as the UV source we used had the output flux high enough to flood the lamp volume with 10^{13} - 10^{14} 254 nm photons per second. The quantum yield for electron emission from near-visible UV has been estimated to about 10^{-3} [18].

We do not expect the photoemission of electrons from the burner wall to play a significant role, because the burner is made of YAG, which is a dielectric material. Consequently, there is no charge redistribution in the material that can follow massive electron emissions. This is why the dielectric surface was not considered as a major electron source under the influence of UV irradiation.

UV irradiation also works as an effective dielectric surface cleaner - if the surface was left charged by electrons in the previous breakdown process, the UV photons have enough energy to detach the charge from the surface [20]. If there were surface discharges forming on the dielectric surface of the lamp burner during the breakdown processes in our experiments, this would mean that the UV irradiation would cause a fundamental deviation from the non-UV-irradiated case. However, our discharges form in the gas volume between the electrodes and do not grow on the surrounding dielectric surfaces.

Another way in which the UV irradiation can possibly influence the breakdown process is the effects it has on the chemistry of the breakdown process. Namely, a 4.9 eV photon has enough energy to ionize an argon or a xenon metastable. The energies needed are 4.2 and 3.2 eV respectively. In this respect, the collisional ionization process by electron impact of the atomic metastables is at least partly replaced by a photoionization process. However, we do not believe that this has a major effect on the breakdown process in either gas. Even if the cross sections for this kind of photoionization were very large, the metastable density in the near-atmospheric pressure gas that is undergoing the transition to become a plasma is not significant enough for this process to create a noteworthy shortcut between the metastable and atomic ion state. In any case, the result would most likely be a modest shortening of the breakdown process, we do not expect the threshold voltage needed for breakdown to be affected.

The formative time could, therefore, be slightly shortened as a consequence of easier ionization of atomic metastables. We must consider the opposite effect as well. It has been shown for pulsed discharges that the overvoltage has a great influence on formative time, namely that the formation time grows as the overvoltage is decreased [21,22]. This effect is caused by the specific link between the Townsend's first ionization coefficient and the reduced electric field $\alpha/p = A \exp(-Bp/E)$ [18], where A and B are gas-specific coefficients. The multiplication of electrons in an avalanche exponentially rises with α , which is itself a steep function of the reduced electric field [18]. Consequently, already a small increase of voltage above the threshold level leads to large reduction of the formative lag time. During the UV-assisted measurements the overvoltage is very small, if present at all. Therefore, the formative time of the UV-assisted breakdown is much larger than that of the non-assisted process. There are, thus, two effects modifying

the formative time of breakdown in our experiments, one reducing it and one magnifying it. If a parallel can be drawn with the work of Moss et al in lower pressures [22], the balance is on the side of formative lag time magnification.

In conclusion, we believe that the only significant influence of the UV irradiation in our experiments is the creation of the free electrons needed to start an electron avalanche, thus effectively reducing the statistical lag to minimum. The increase of the formative lag is negligible when considering both effects on the same time scale.

4.4. Role of ^{85}Kr

The presence of ^{85}Kr in our experiments was shown to cause some lowering of the breakdown voltage and no change in the standard deviation from the mean of the measured values, which would suggest that there is no reduction of the statistical lag. As a direct source of electrons, at the first glance, it was supposed to provide the gas volume with enough free electrons to start an electron avalanche and reduce the statistical lag.

Here we would like to direct the reader's attention to the very small volume of the lamps in question, i.e. $3.6 \times 10^{-7} \text{ m}^3$. The low level of radioactivity we used produces only about 900 high-energy electrons per second in the entire lamp, at 1 bar. Scaled down to 0.7 or 0.3 bar, we get 630 and 270 high-energy electrons emitted in the lamp volume per second, respectively. Given that each of our breakdown experiments takes roughly between 10 and 50 ms for the voltage slope of 100 V/ms, we can expect 6 to 31 high-energy electrons per experiment in 0.7 bar lamps and 3 to 13 electrons in 0.3 bar Ar atmosphere. The fact that there are so few electron emission events per experiment can explain the big statistical spread in the measurements, when compared to the UV-assisted measurements, in which about 10^7 more electrons are generated per second.

Such a small number of emitted electrons per breakdown process gives rise to large statistical lag time. However, every one of these electrons is capable of starting an electron avalanche in the lamp. As the maximum high-energy emitted electron energy is 687 keV, while the mean value is 251 keV, there is a high probability that in the case of a collision with an atom in the gas, or with the burner wall or the electrode surface, this electron will start an electron avalanche. We have calculated that the average distance the 0.2 MeV electrons can travel in 0.3 and 0.7 bar argon before the first collision with a gas atom is 1 mm and 0.45 mm respectively. Therefore, the high-energy electrons are likely to hit any of the three possible targets (an atom, the electrode or the dielectric surface) and start an electron avalanche.

The possible benefits from the usage of radioactive materials such as ^{85}Kr are evident. Even the low dosage we used in our experiments, and which is typical dosage used in HID lamps, proved to be enough to make a difference in HID-sized lamps. However, a higher dosage or a longer time available for breakdown are expected to give better results because they should effectively provide the same - more free electrons

during the breakdown process.

5. Conclusions

An experimental investigation of the AC breakdown process was performed in argon and xenon. We have demonstrated that the discharges form more easily in argon than in xenon and offered an explanation based on the differences in electron-atom collision frequencies. The existing explanations as to why the AC breakdown requires lower voltage than the matching pulsed breakdown process were reviewed, and some of our own were offered. The changes in electron loss due to drift were found not to have a large role in the lowering of the breakdown voltage as the frequency was increased; the secondary electron emission from the electrode surface had a more important impact. More precisely, molecular ions were suggested as the heavy species to control the secondary electron emission from electrode surface by ion impact. When considering the influence of two kinds of ignition aid, we established that the main effect was the lowering of the statistical lag.

Acknowledgments

This work was supported by Philips Lighting, Eindhoven. The authors would also like to thank dr. Li Chao of Eindhoven University of Technology for his help with the data concerning the high-energy electrons in argon.

References

- [1] W Pfeiffer. High-frequency voltage stress of insulation. Methods of testing. *IEEE Trans. Electr. Insul.*, 26:239–46, 1991.
- [2] J Park, I Henins, H W Herrmann, and G S Selwyn. Gas breakdown in an atmospheric pressure radio-frequency capacitive plasma source. *J. Appl. Phys.*, 89(1):15–9, 2001.
- [3] J J Shi and M G Kong. Large-volume and low-frequency atmospheric glow discharges without dielectric barrier. *Appl. Phys. Lett.*, 86:091502, 2005.
- [4] J L Walsh, Y T Zhang, F Iza, and M G Kong. Atmospheric-pressure gas breakdown from 2 to 100 MHz. *Appl. Phys. Lett.*, 93:221505, 2008.
- [5] K Koppisetty and H Kirkici. Breakdown characteristics of helium and nitrogen at kHz frequency range in partial vacuum for point-to-point electrode configuration. *IEEE Trans. Dielectr. Electr. Insul.*, 15(3):749–55, 2008.
- [6] B Sießegger, H Guldner, and G Hirschmann. Ignition concepts for high frequency operated HID lamps. In *Proceedings of 36th IEEE Power electronics specialists conference*, pages 1500–6, 2005.
- [7] J Beckers, F Manders, P C H Aben, W W Stoffels, and M Haverlag. Pulse, dc and ac breakdown in high pressure gas discharge lamps. *J. Phys. D: Appl. Phys.*, 41:144028, 2008.
- [8] J M Meek and J D Craggs. *Electrical breakdown of gases*. Oxford University press, 1953.
- [9] D H Hale. The breakdown of gases in high frequency electrical fields. *Phys. Rev.*, 73(9):1046–52, 1948.
- [10] A Sobota, J van Dijk, and M Haverlag. AC breakdown in near-atmospheric pressure noble gases: II. Simulations. *Submitted to J.Phys.D.:Appl.Phys.*

- [11] T M P Briels. *Exploring streamer variability in experiments*. PhD thesis, Technische Universiteit Eindhoven, 2007.
- [12] A Sobota, A Lebouvier, N J Kramer, E M van Veldhuizen, W W Stoffels, F Manders, and M Haverlag. Speed of streamers in argon over a flat surface of a dielectric. *J. Phys. D: Appl. Phys.*, 41:015211, 2009.
- [13] A Sato, N Brates, K Noro, N Y Babaeva, and M J Kushner. Effect of pulse voltage slope on high pressure xenon hid lamps breakdown voltage. In G M W Kroesen M Haverlag and T Taguchi, editors, *Proceedings of the 12th International Symposium on the Science and Technology of Light Sources and the 3rd International Conference on White LEDs and Solid State Lighting*. FAST-LS Ltd., 2010.
- [14] G J M Hagelaar and L C Pitchford. Solving the boltzmann equation to obtain electron transport coefficients and rate coefficients for fluid models. *Plasma Sources Sci. technol.*, 14:722–33, 2005.
- [15] Electron-neutral collision cross sections, compilation of electron cross sections used by A. V. Phelps. <http://jila.colorado.edu/~avp/collision.data/electronneutral/ELECTRON.TXT>.
- [16] M J Kushner. Arc expansion in xenon flashlamps. *J. Appl. Phys.*, 57(7):2490–2500, 1985.
- [17] A N Bhoj and M J Kushner. Avalanche process in an idealized lamp: II. Modelling of breakdown in Ar/Xe electric discharges. *J.Phys.D:Appl.Phys.*, 37:2510–26, 2004.
- [18] Yu P Raizer. *Gas discharge physics*. Springer Verlag, Berlin, 1991.
- [19] W W Byszewski, Y M Li, A B Budinger, and P D Gregor. Advances in starting high-intensity discharge lamps. *Plasma Sources Sci. Technol.*, 5:720–35, 1996.
- [20] E Kindel and R Arndt. Wall charge behaviour in external electrode gas discharges. *Beiträge aus der Plasmaphysik*, 21:411–421, 1981.
- [21] L H Fisher. Formative time lags of spark breakdown. *Appl. Sci. Res.*, B(5):281–4, 1956.
- [22] R A Moss, J G Eden, and M J Kushner. Avalanche process in an idealized lamp: I. Measurements of formative breakdown time. *J.Phys.D:Appl.Phys.*, 37:2502–9, 2004.