



HAL
open science

Experimental Investigation of Steam Pressure Coffee Extraction in a Stove-top Coffee Maker

L. Navarini, E. Nobile, F. Pinto, A. Scheri, F. Suggi-Liverani

► **To cite this version:**

L. Navarini, E. Nobile, F. Pinto, A. Scheri, F. Suggi-Liverani. Experimental Investigation of Steam Pressure Coffee Extraction in a Stove-top Coffee Maker. *Applied Thermal Engineering*, 2010, 29 (5-6), pp.998. 10.1016/j.applthermaleng.2008.05.014 . hal-00618977

HAL Id: hal-00618977

<https://hal.science/hal-00618977>

Submitted on 5 Sep 2011

HAL is a multi-disciplinary open access archive for the deposit and dissemination of scientific research documents, whether they are published or not. The documents may come from teaching and research institutions in France or abroad, or from public or private research centers.

L'archive ouverte pluridisciplinaire **HAL**, est destinée au dépôt et à la diffusion de documents scientifiques de niveau recherche, publiés ou non, émanant des établissements d'enseignement et de recherche français ou étrangers, des laboratoires publics ou privés.

Accepted Manuscript

Experimental Investigation of Steam Pressure Coffee Extraction in a Stove-top Coffee Maker

L. Navarini, E. Nobile, F. Pinto, A. Scheri, F. Suggi-Liverani

PII: S1359-4311(08)00229-9
DOI: [10.1016/j.applthermaleng.2008.05.014](https://doi.org/10.1016/j.applthermaleng.2008.05.014)
Reference: ATE 2515

To appear in: *Applied Thermal Engineering*

Received Date: 20 December 2007
Revised Date: 16 April 2008
Accepted Date: 13 May 2008

Please cite this article as: L. Navarini, E. Nobile, F. Pinto, A. Scheri, F. Suggi-Liverani, Experimental Investigation of Steam Pressure Coffee Extraction in a Stove-top Coffee Maker, *Applied Thermal Engineering* (2008), doi: [10.1016/j.applthermaleng.2008.05.014](https://doi.org/10.1016/j.applthermaleng.2008.05.014)

This is a PDF file of an unedited manuscript that has been accepted for publication. As a service to our customers we are providing this early version of the manuscript. The manuscript will undergo copyediting, typesetting, and review of the resulting proof before it is published in its final form. Please note that during the production process errors may be discovered which could affect the content, and all legal disclaimers that apply to the journal pertain.

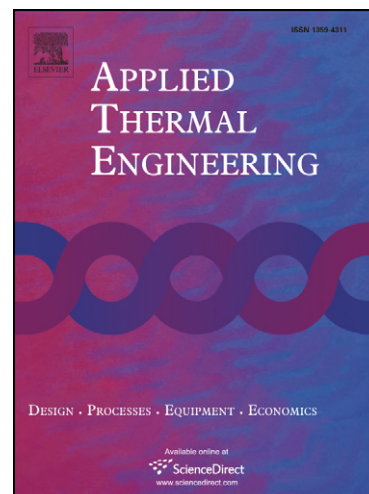

Experimental Investigation of Steam Pressure Coffee Extraction in a Stove-top Coffee Maker

L. Navarini^a, E. Nobile^b, F. Pinto^{b,*}, A. Scheri^b

F. Suggi-Liverani^a

^a*illycaffè S.p.A., Via Flavia, 110, 34147 Trieste, ITALY*

^b*DINMA – Sezione di Fisica Tecnica, Università di Trieste, Via A. Valerio, 10 –
34127 Trieste, ITALY*

Abstract

The most common household brewing method in Italy makes use of a stove-top coffee-maker known as *moka*. This device uses the steam pressure, produced by the water contained in an autoclave-type aluminum kettle heated by an external source, to force upwards water itself through a roasted and ground coffee bed contained in a funnel-shaped filter. Despite its well-established usage, the *moka* has never been the subject of detailed analysis, which led to a series of unclear descriptions or misinterpretations concerning its functioning, such as the consolidated misbelief that standard atmosphere boiling point temperature is needed to drive the water out. The detailed measurement of the thermodynamics of the *moka*, described here, sheds light on its actual behaviour. It is shown that extraction commences at pretty low temperatures and depends on the initial amount of dry air in the kettle. Remarks on the time decreasing value of the coffee bed permeability are also drawn. A correct understanding of the extraction phenomenon, together with considerations on the coffee chemistry, serves the purpose of assessing possible ways to improve

the quality of *moka* product.

Key words: Coffee, Moka, brewing

1 Introduction

The most popular household coffee-brewing method in Italy is that performed by using an inexpensive stove-top coffee-maker invented by the aluminum technologist Alfonso Bialetti in 1933 [1,2]. This coffee-maker was industrially produced and commercialized, by the Inventors son Renato from 1946, with the trademark denomination of “Moka Express”, but, nowadays, it is simply known as *moka*. In its original version, *moka* consists of two octagonal conoids, which can be regarded as the very epitome of Italian household hardware, and in this version has racked up sales of more than 105 million units since market launch [1], with an actual production of 4 million pieces per year [3]. During the '70s, the *moka* attracted the attention of several designers which reinvented the shape without remarkably affecting the overall proportion, and by the '80s stainless steel started to parallel aluminum as *moka* construction material [4].

Due to its low cost and easy-to-handle characteristics, *moka* is used, albeit not extensively, also in others countries where is also known as stove-top *espresso* or often misnamed *mocha* or *moca*. An exception is represented by Spain where it is known as *napolitana*, *cafetera de rosca*, *cafetera de fuego* or *italiana* and

* Corresponding author.

Email addresses: Luciano.Navarini@illy.it (L. Navarini), nobile@units.it (E. Nobile), fpinto@units.it (F. Pinto), alessio.scheri@libero.it (A. Scheri), suggif@illy.it (F. Suggi-Liverani).

18 its use is spread almost like in Italy [5,6,7], and Portugal where it is known as
19 *cafeteira italiana*.

20 This ingenious device uses the steam pressure, produced by the water con-
21 tained in an autoclave-type aluminum kettle heated by an external source
22 (gas or electrical stove), to force upwards the same water through a roasted
23 and ground coffee bed contained in a funnel-shaped filter. The beverage is
24 conveyed through appropriate tubing into an upper vessel, screwed and sealed
25 by a rubber gasket to the base kettle. The end of the brewing operation is
26 usually announced by noisy mixture of boiling water and its vapour flowing
27 from the upper tube, to indicate water depletion [8,9].

28 Undoubtedly, a relevant part of the success of the *moka* coffee-maker has been
29 played by the word “Express” in its trademark denomination. In facts this
30 word evokes the worldwide well known *espresso* coffee brew, which is prepared
31 by very different coffee machine and it is also organoleptically very different
32 from *moka* coffee brew.

33 Italian *espresso* is a beverage prepared on request from roasted and ground
34 coffee beans by means of hot ($90 \pm 5^\circ\text{C}$) water pressure (9 ± 2 bar) applied for a
35 short time (30 ± 5 s) to a compact roast and ground coffee cake (6.5 ± 1.5 g) by
36 a percolation machine, to obtain a small cup of a concentrated foamy elixir [8].

37 Unfortunately, the main factors controlling the coffee extraction in the *moka*,
38 such as the thermodynamic relationship between water pressure and temper-
39 ature, the Darcys law of linear filtration [9] as well as the physico-chemical
40 nature of roasted and ground coffee, led to a beverage sometimes partially
41 characterized by harsh bitter flavour often describe as “burnt”, and by lack of
42 the foam layer typical of true Italian *espresso* coffee brew [8]. Differently from

43 espresso coffee machine, the thermal balance of *moka* is somewhat flimsy, be-
44 ing affected by several variables not easy to control [8]. It has been suggested
45 that the main feature, shared by *moka* and *espresso*, is the fact that water
46 wets the grounds once through, increasing the extraction yield by fresh solvent
47 power [8].

48 It is clear that, in order to objectively interpret the differences between *moka*
49 and *espresso* brewing methods, it is necessary to study in detail the *moka*
50 functioning.

51 The *moka* coffee extraction physics, inspired from a primordial washing ma-
52 chine known as *lisciveuse* [1], in turn derived from the steam engine of a couple
53 of centuries ago [4], have not been the subject of detailed studies.

54 It has to be stressed out that, a part of a plethora of surprisingly unconceivable,
55 physically uncorrect or simply vague functioning descriptions published even
56 on scientific literature [5,6,10,11], the only one paper dealing more correctly,
57 although not thoroughly, with the *moka* physics has been published 74 years
58 after the *moka* invention [9].

59 In this work, we attempt to fill this gap by performing detailed measurements
60 on a standard commercial *moka*, in order to better understand its underlying
61 physics and functioning characteristics. In addition, the availability of an ex-
62 perimental database, constitutes a necessary requirement for the development
63 and validation of a mathematical model of the device. This, in turn, can be
64 particularly useful for parametric analysis and/or optimization studies.

65 The present work, to the authors' best knowledge, is the first experimental
66 attempt to investigate in detail the *moka* physics in order to put in evidence

67 misinterpretations or myths, and to assess how this physics affects the beverage
68 quality.

69 2 Experimental Setup

70 Among the different types of stove-top coffee makers available on the market,
71 *MOKA EXPRESS*[®], produced by Bialetti Industrie S.p.A., Omegna(VB),
72 Italy, is the most largely used household device. It is a stove-top aluminum
73 coffee maker, made in different sizes, and its 3 cups version has been used in
74 the experiments. The coffee maker is composed of a 220 cm³ capacity lower
75 tank, a 50 cm³ capacity funnel shaped filter, a washer, a downstream filter
76 plate, and a topper pot, as shown in figure 1.

77 2.1 Operative conditions

78 The experiments have been conducted for a standard usage of the 3 cups *moka*,
79 which is considered to be a 150 g of water filling of the tank, and a 15 g of
80 coffee filling of the funnel. The coffee employed is a 100% *Coffea arabica* L.
81 blend with a medium roasting degree (total weight loss 16%) , coarsely ground
82 powder for stove-top coffee makers. An electrical stove has been used to heat
83 the coffee maker for two different values of heating power. Two series of 10
84 experiments at 400 W and 600 W have been made.

85 2.2 Data acquisition system

86 In order to collect the data from the test rig, a National Instruments (NI)
87 SCXI-1300 General-purpose voltage module has been used; it is connected to
88 a SCXI-1102B channel amplifier, and mounted on a SCXI-1000 chassis. The
89 chassis is connected to a PC through a NI PCI-6221 data acquisition (DAQ)
90 device. The software used is LabView version 7, which allow to directly process
91 the input voltage data into desired physical quantities, by programming *virtual*
92 *instruments* (VIs).

93 2.3 Temperature measurements

94 In order to better understand the phenomenon of the steam pressure coffee ex-
95 traction, a series of temperature sensors have been installed. Four probes have
96 been used to infer temperature at different points within the lower tank, where
97 part of the hot water turns into vapour, whose pressure supports the extrac-
98 tion. These probes, numbered TI[0 – 3], are Chromel/Alumel thermocouples
99 with U (insulated) hot junction and 1.6 mm inconel sheath. They are mounted
100 in pairs on 2 bolts with 8M thread, and screwed on the lower tank. Six probes,
101 numbered TE[4 – 9], have been used to measure the external temperature of
102 the tank and the pot, in order to assess the heating behaviour, and collect the
103 most available data. They have been realized with Chromel/Alumel cable type
104 GG-30-KK, and they have been fixed to the device with an epossidic bicom-
105 ponent resin. Two more Chromel/Alumel thermocouples with insulated hot
106 junction have been used to measure the temperature of the aqueous extract
107 (coffee) in the little column of the top pot.

108 A sketch of the coffee maker with a schematic view of probes positioning is
109 presented in figure 2(a).

110 *2.4 Pressure Probe*

111 The vapour-air mixture pressure in the lower tank has been monitored by
112 means of a Wheatstone bridge-based sensor, produced by Kulite. The model
113 used, XTEL-190-100D, is a 0–7 bar (100 PSI) pressure range transducer, op-
114 erating in differential mode, with temperature compensation between 80 °C
115 and 275 °C.

116 *2.5 Mass flow measure*

117 For detecting the water level inside the tank at different height, eight resistive
118 circuits have been used. Their electrical scheme is sketched in figure 2(b). Each
119 circuit is composed of a 9V D.C. generator and a 7.5M Ω resistance, and it
120 is connected to the DAQ system. Inside the tank, the circuits are made of
121 copper wires insulated with high temperature silicone. The system senses a
122 discontinuous resistance variation as the tip of the wire gets out of the water.

123 *2.6 Heater*

124 The heating source used is a common 600 W electric cooker, whose tempera-
125 ture has been monitored and kept as steady as possible during the experiments.

126 3 Results and Discussions

127 3.1 In-tank Thermodynamic Behaviour

128 Figure 3 shows the pressure and temperature histories in the tank, for a rep-
129 resentative experiment with a heating power of 400 W. The temperatures in
130 this figure are those obtained from the four probes TI [0–3] that, as indicated
131 in figure 2(a), are positioned at different heights.

132 It is an article of faith, among stove-top coffee maker users, to think that
133 standard atmosphere boiling point temperature is needed to drive the water
134 out of the tank [6], and to think that the pressure rise is due to thermodynamic
135 equilibrium between water and its vapor in saturation conditions [11]. While
136 the first of these common beliefs might, at a first sight, be justified by figure 3,
137 where a sensible pressure rise is perceived at about 90 °C of the water, the
138 second is clearly disproved. TI0 probe is in contact with the bottom of the tank
139 and senses the temperature of the water layer adjacent to the wall. TI1 and TI2
140 probes are immersed in water for most of the extraction time and give almost
141 equivalent values for the water temperature, apart from slight oscillations due
142 to convective plumes. On the other hand, TI3 probe, which is positioned at
143 the top of the tank, measures the temperature of the air-vapour mixture. This
144 temperature is considerably lower than the water temperature, which indicates
145 lack of thermodynamic equilibrium during the extraction process.

146 Figure 4 shows the temperature of the water TI2 inside the tank and the 8
147 measurements of water flowed. It reveals that, despite the first impression,
148 even the first conviction is wrong. In fact, extraction commences at lower

149 temperatures.

150 It is interesting to observe that the *moka* behaviour can be split into two
151 phases. Up to approximately 120 g of water flowed, the lower tank air-vapour
152 mixture and the evaporating water can be considered a closed system, whose
153 pressure, increased by sensible heat and water evaporation, drives the extrac-
154 tion of the coffee. We name this phase *regular extraction phase*. In this phase
155 liquid-solid extraction occurs.

156 When the water level in the tank reaches the end of the funnel, there is a
157 short-cut between external ambient and internal air-vapour mixture, which
158 no more drives in-tank water out of the tank. At this point, the remaining
159 water undergoes intense evaporation. We name this phase, announced by a
160 well-known rattling sound, *strombolian phase*, because of its typical volcano-
161 like behaviour. Figure 5 depicts the different phases during extraction.

162 High temperature extraction fluids (vapour, water and their mixture) tran-
163 sit in the coffee bed is noxious for the quality of the extract because, under
164 these conditions, such fluids are more efficient in solubilizing less soluble com-
165 pounds, generally conferring bitterness and astringency [12], and/or in strip-
166 ping least volatile aroma compounds which are organoleptically unpleasant
167 and described as clove-like, smoky, burnt, medicinal/chemical [13]. This is
168 witnessed by an extraction yield (defined as the percentage of the brew to-
169 tal solids with respect to ground and roasted coffee dose) which is generally
170 higher in comparison with the other brewing methods (e.g. filter, *espresso*,
171 plunger or “French Press”). In particular extraction yield ranging from 18 to
172 22% have been proposed as the most acceptable, as far as brews quality is
173 concerned. The coffee brews below 16% are considered to be under-extracted

174 and those above 24% are considered to be over-extracted [13]. Independently
 175 on the coffee used (quality and quantity), values from $27.59 \pm 0.28\%$ [7] to
 176 31.9% [8] have been reported. In a comparison between *moka* and *espresso*
 177 coffee extraction methods, the beverage concentration range suggested to be
 178 optimal for quality ($> 2\%$ for *moka* and $> 3\%$ for *espresso*) has been obtained
 179 by *moka* operating under conditions of coffee dose and powder particle size
 180 distribution leading to an extraction yield higher than 30% [14] and outside
 181 the optimal range suggested by the same authors (18 – 25%).

182 *Strombolian* phase, corresponding to a vapour-liquid-solid extraction, is dif-
 183 ficult to study because of its complex thermodynamics, while more detailed
 184 considerations can be drawn from the regular extraction phase.

Measured water level data have been fitted with an exponential regression for
 each experiment, as illustrated in figure 4. The function used is:

$$m = -a + a e^{b\tau} \quad (1)$$

185 where m is the water flowed in grams and τ is the time elapsed from the
 186 beginning of the experiment. The water flow, \dot{m} , is easily obtained by deriving
 187 (1). The mean correlation coefficient between measured data and regression
 188 model for all the experiments is 0.9963 and 0.9948, for 400 W and 600 W
 189 heating power, respectively.

The mean in-tank water temperature, \bar{T}_w , has been calculated:

$$\bar{T}_w = \frac{\int T \dot{m} d\tau}{\dot{m} d\tau} \quad (2)$$

190 and is reported in table 1, together with the initial and final extraction tem-
 191 peratures. Table 1 shows that the initial in-tank extraction temperatures are

192 clearly below the misbelieved value of 100 °C, with great part of the water
 193 flowing at quite low temperatures. In table 1, the initial in-tank water tem-
 194 perature is considered at 10 g of water flowed, which is the first value sensed
 195 by the water level measurement apparatus. Whereas the final in-tank water
 196 temperature is taken at 120 g of water flowed, considered as the beginning of
 197 the *strombolian* phase.

At the beginning of the heating process, the tank has 20 cm³ of space occupied
 by air, which we may consider, for simplicity, at saturated conditions. During
 the extraction, the pressure contribution due to air can be deduced by applying
 ideal gas law and the regression model for water flow. Pressure due to dry air
 is calculated as follows:

$$p_{air}(\tau) = \frac{TI3(\tau) p_{(air,o)} V_o}{V_{air}(\tau) T_o} \quad (3)$$

where $p_{(air,o)}$, V_o , and T_o are the initial partial pressure, volume and tem-
 perature of dry air, respectively, $TI3(\tau)$ is the temperature measured by the
 higher in-tank temperature probe, and $V(\tau)$ is the volume occupied by air at
 a certain time τ , which depends on eq. (1):

$$V_{air}(\tau) = \frac{m}{\rho_w} + V_o \quad (4)$$

198 where ρ_w is the water density.

199 It has been already stressed out the absence of thermodynamic equilibrium
 200 between liquid and vapour phases of water, which results in a temperature
 201 difference sensed by probes whether immersed or not. Vapour conditions are
 202 driven by both evaporation from liquid-vapour separation surface and convec-
 203 tive heat transfer with each surrounding surface. A question arise on whether
 204 vapour is at saturated or overheated conditions, which is not possible to an-

205 swer precisely. Nevertheless, vapour formation and heating can be considered
206 driven mainly by evaporation. So, in order to estimate the pressure due to
207 water vapour, saturated vapour at air-vapour temperature, T_{I3} , rather than
208 in-tank water temperature, has been assumed. Values are obtained by means
209 of IAPWS IF-97 tables. Figure 6 depicts a representative experiment, and it
210 shows that very good agreement exists between our assumptions and mea-
211 sured pressure. This reveals the major contribution of dry air in leading the
212 extraction, and it will be the subject of further detailed analysis.

213 3.2 Aqueous extract

214 The funnel shaped filter has 50 cm^3 capacity and is filled with 15 g of coffee.
215 Coffee true density is 1190 kg/m^3 [15], thus the coffee bed filling ratio is 0.244.
216 The first drop of aqueous extract is sensed by TC10 probe after the funnel
217 has been completely filled by water, completing the *imbibition phase*. This
218 happens when an approximative amount of 40 g of water has flowed out of
219 the lower tank. This can be noticed in figure 7, when TC10 probe experience
220 a sudden temperature variation due to the contact with the aqueous extract.
221 In the imbibition phase no pressure drop is sensed, partly because the water
222 flow is low, and partly because in this phase the coffee matrix presents low
223 resistance to water penetration. During imbibition and extraction phases the
224 coffee undergoes chemical transformations due to the interaction with water,
225 which substantially change its properties [16,17]. The coffee bed water inva-
226 sion, during the imbibition phase, induces the solubilization of more soluble
227 and low molecular weight compounds, as well as more volatile aromatics (low
228 temperature/pressure extraction). Simultaneously, there is the coffee bed par-

229 ticle swelling, due to the swelling of water-insoluble polysaccharides present in
230 the roasted coffee [16], and with the geometrical rearrangement of the coffee
231 particles due to upwards water flow [18]. As soon as the coffee bed swelling
232 and spatial rearrangement provoke the progressive decrease of the coffee bed
233 porosity, the extraction proceeds at increasing temperatures/pressures, thus
234 making the decrease in coffee bed porosity and the solubilization of coffee
235 compounds competitive phenomena. The process goes on up to the starting of
236 the *strombolian* phase, which marks the passage from a closed thermodynamic
237 system to an open one.

238 In its passage through the coffee bed, water transfers part of its heat to the
239 bed itself. Aqueous extract temperatures are sensibly lower than that of the
240 in-tank water. This is clearly visible in figure 7, where the extracted coffee has
241 a much lower temperature, TC10, than that, TI2, of the water in the tank.

242 After 120 g of water flowed the *strombolian* phase begins, and no accurate
243 measurements of the extraction phenomenon can be made. As highlighted in
244 figure 7(b), a limited zone in between 50 g and 120 g of water flowed has been
245 considered. In table 2 the initial, final, and mean extract temperatures for the
246 restricted zone are presented.

247 A preliminary granulometric analysis of the coffee cake, after the brewing
248 process, reveals an almost uniform distribution, with a variation in both av-
249 erage and medians particle size 9% and 14%, respectively, along the water
250 path. This suggests a linear decay assumption for pressure. Taking into con-
251 sideration both conductive and advective terms in the transport phenomenon,
252 it can be shown that the temperature profile in the cake is slightly concave
253 but, for simplicity, in the transit through the coffee bed, which in our case is

254 21 mm thick, pressure and temperature profiles can be considered linear with
 255 a good approximation. In figure 8 pressure and its saturation temperature are
 256 compared to the aqueous extract temperature through the coffee bed at the
 257 end of the regular extraction phase, where high in-tank pressure is present.
 258 During *regular* extraction, water temperature is always lower than saturation
 259 temperature, thus the risk of local evaporation in the bed is avoided.

260 3.3 Mass flow analysis

261 Applying Darcy's law, in [9] Gianino derives the permeability of the coffee
 262 bed from an integral balance, assuming constant thermophysical properties
 263 for water and coffee powder. The value Gianino finds is 2300 millidarcy¹
 264 [mD]. We will show that this is a way too rough approximation.

Again we will consider the limited zone in between the imbibition and strom-
 bolian phases (50 g and 120 g of water flowed), where sensible pressure data
 are obtained, and measurements of the water flow are possible. Darcy's law
 states:

$$q = -\frac{\kappa \Delta P}{\mu L} \quad (5)$$

265 where $q = \dot{m}/(\rho A)$ is the water volumetric specific flow-rate, κ is the per-
 266 meability of the coffee cake, μ is the dynamic viscosity of water, ΔP is the
 267 pressure drop experienced during filtration, and L is the thickness of the bed.
 268 During filtration, aromatic substances solve into water, thus changing its rhe-
 269 ological properties. Nevertheless, considering pure water as reference point, a
 270 time varying value of κ can be obtained. Figure 9 depicts the time-varying
 271 permeability value for a representative experiment, where the pressure drop

¹ 1 millidarcy = $1 \times 10^{-15} \text{ m}^2$

272 has been taken neglecting the head and the friction losses, which give minimal
273 contribution. The value of κ , as expected, gradually decays to an asymptotic
274 condition, which confirms former experiments on *espresso* machines, described
275 in [19]. From figure 9 it is evident that typical ranges for κ in the regular ex-
276 traction region is 70-400 mD, which is more than 10 times lower than the value
277 obtained in [9].

278 4 Conclusions

279 In this paper, an experimental study of a stove-top coffee maker, known as
280 *moka*, has been described. Despite its quite simple manufacture and function-
281 ing, it has been shown that the thermodynamic behaviour of the *moka* device
282 is complex in comparison to other coffee brewing methods.

283 The brewing process of *moka* has been divided into two phases. In the *regular*
284 *extraction* phase liquid-solid extraction occurs, which presents time varying
285 temperature and water flow rate. In this phase extraction is driven by increas-
286 ing air-vapour pressure above the water level in the lower tank of the device.
287 The pressure increase is due not only to time increasing flow rate, but also
288 to a non constant rheological behaviour of the coffee cake, whose permeabil-
289 ity decreases with time as the coffee undergoes chemical reactions, which in
290 turn decrease its porosity. Moreover, the stove heating power, which is usu-
291 ally constant during the process, exceeds the actual requirement in the final
292 stages of the extraction, when a little fraction of water is still in the tank
293 and consequently its heat capacity diminish, resulting in pressure and flow
294 rate augmentation. An analysis of pressure contributions has highlighted the
295 role played by dry air in the overall phenomenon, which is not negligible as

296 believed by many. The quantity of dry air can influence both temperature and
297 flow rate, thus affecting final extract quality, and it is meant to be subject of
298 further studies. When water level reaches the end of the funnel, the short-cut
299 between external ambient and air-vapour mixture, which no more drives in-
300 tank water out of the tank, causes an intense evaporation, named *strombolian*
301 *phase*. In this phase vapour-liquid-solid extraction occurs, with consequent
302 extraction of soluble compounds which are generally noxious for the quality
303 of the final product. The higher the pressure and temperature, the higher the
304 extraction of undesired components.

305 The detailed measurement of the thermodynamic behaviour of the *moka* which,
306 to the authors' best knowledge, is the first solid experimental attempt of in-
307 vestigation, serves the purpose of an intimate understanding of such a popu-
308 lar, yet mysterious, device, which so much diverges from other coffee brewing
309 methods, in order to assess possible ways to improve the quality of its product.

310 References

- 311 [1] D. Samarelli, Omegna, paese di pentole e caffettiere: La pentola a
312 pressione Lagostina e la Moka Express Bialetti, Quaderni della Biblioteca,
313 Amministrazione Comunale, Omegna (VB), Italy, 1990, in Italian.
- 314 [2] Bialetti, I segreti del Caffè, DE & CO Immagine e Comunicazione, Milano,
315 Italy, 1995, in Italian.
- 316 [3] J. Myron, The story of the bialetti moka express (2007) [http://www.
317 ineedcoffee.com](http://www.ineedcoffee.com).
- 318 [4] S. Gronert, The 9090 Cafetière by Richard Sapper, Verlag form GmbH,
319 Frankfurt am Main, 1997.

- 320 [5] A. Peters, Brewing makes the difference, in: Proceedings of the 14th ASIC
321 Colloquium (San Francisco), ASIC, Paris, France, 1991, pp. 97–106.
- 322 [6] P. Parras, M. Martinez-Tom, A. Jimenez, M. Murcia, Antioxidant capacity
323 of coffees of several origins brewed following three different procedures, Food
324 Chemistry 102 (2007) 582–592.
- 325 [7] I. Lopez-Galilea, M. Paz De Pena, C. Cid, Correlation of selected constituents
326 with the total antioxidant capacity of coffee beverages: Influence of the brewing
327 procedure, J. Agric. Food Chem. 55 (15) (2007) 6110–6117.
- 328 [8] M. Petracco, Beverage preparation: Brewing trends for the new millennium, in:
329 R. Clarke, O. Vitzthum (Eds.), Coffee: recent developments, Blackwell Science,
330 Oxford, 2001.
- 331 [9] C. Gianino, Experimental analysis of the italian coffe pot “moka”, Am. J. Phys.
332 75 (1) (2007) 43–47.
- 333 [10] R. Clarke, R. Macrae (Eds.), Coffee Vol. 2: Technology, Elsevier Applied
334 Science, London, 1989.
- 335 [11] A. Varlamov, G. Balestrino, La fisica di un buon caffè, Il Nuovo Saggiatore
336 17 (3-4) (2001) 59–66, in Italian.
- 337 [12] M. Petracco, in: A. Illy, R. Viani (Eds.), Espresso Coffee. The Science of Quality
338 2nd Edition, Elsevier Academic Press, Oxford, 2005.
- 339 [13] T. Lingle, Coffee brewing control chart, in: T. Lingle (Ed.), The Coffee Cuppers’
340 Handbook. A systematic guide to the sensory evaluation of coffee’s flavour,
341 Specialty Coffee Association of America, Long Beach, 2001.
- 342 [14] C. Severini, S. Giuliani, G. Pinnavaia, Survey on the different methods of coffee
343 extraction, Industrie delle Bevande 22 (1994) 227–230, in Italian.

- 344 [15] P. Singh, R. Singh, S. Bhamidipati, S. Singh, P. Barone, Thermophysical
345 properties of fresh and roasted coffee powders, J. of Food Process Engineering
346 20 (1) (1997) 3150.
- 347 [16] D. Rivetti, L. Navarini, R. Cappuccio, A. Abatangelo, F. Suggi Liverani,
348 Effect of water composition and water treatment on espresso coffee percolation,
349 Electronic Proceedings (CD-ROM) of the 19th ASIC colloquium, Trieste (Italy),
350 Association Scientifique Internationale du Café, Paris (France), 2001.
- 351 [17] O. Fond, Effect of water and coffee acidity on extraction. Dynamics of coffee
352 bed compaction in espresso type extraction, Proceedings of the 16th ASIC
353 colloquium, Kyoto (Japan), Association Scientifique Internationale du Café,
354 Paris (France), (1995) 413-421.
- 355 [18] L. Odello, Moka: l'altro volto del caffè made in Italy, L'Assaggio 19 (2007) 43-49,
356 in Italian.
- 357 [19] G. Baldini, Filtrazione non lineare di un fluido attraverso un mezzo poroso
358 deformabile, Thesis, University of Florence, in Italian (1992).

Table 1
Temperatures of in-tank water during extraction

Heat Flux	Initial		Final		Mean	
	mean	std	mean	std	mean	std
400 W	68.7	2.7	117.2	1.2	94.3	1.6
600 W	70.2	2.9	120.6	3.0	97.6	1.2

Table 2
Temperatures of aqueous extract

Heat Flux	Initial		Final		Mean	
	mean	std	mean	std	mean	std
400 W	63.0	2.0	95.8	2.9	78.8	1.5
600 W	61.8	2.5	97.7	2.4	80.5	1.3

359 **List of Figures**

360	1	Coffee maker parts: a) topper pot; b) downstream filter plate;	
361		c) washer; d) funnel shaped filter; e) lower tank	22
362	2	Coffee maker sketch: a) probes positioning; b) water level	
363		detector scheme	23
364	3	In-tank temperature histories: a) whole experiment; b) detailed	
365		view of the late phase of extraction.	24
366	4	In-tank temperature, pressure, and water flowed	25
367	5	extraction phases: a) beginning; b) regular extraction;	
368		c) strombolian extraction	26
369	6	Pressure contribution of dry air and saturated vapour	27
370	7	a) Aqueous extract temperature at the exit of the coffee bed;	
371		b) detailed view	28
372	8	Temperature profiles in the coffee bed at 120 g of water flowed	29
373	9	Time varying permeability profile	30

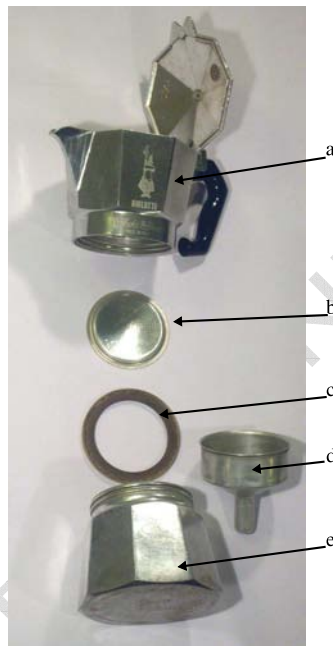
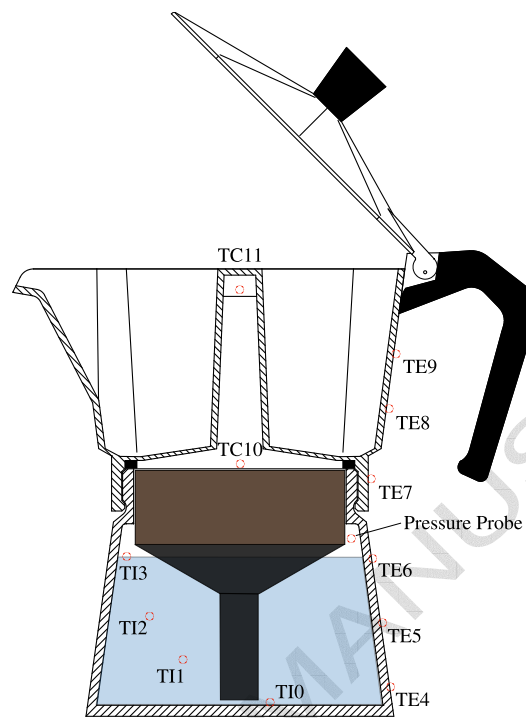
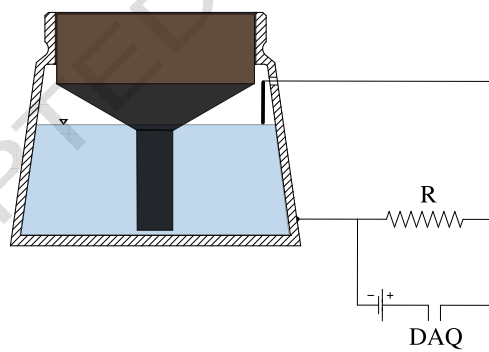

Fig. 1. Coffee maker parts: a) topper pot; b) downstream filter plate; c) washer; d) funnel shaped filter; e) lower tank



(a)



(b)

Fig. 2. Coffee maker sketch: a) probes positioning; b) water level detector scheme

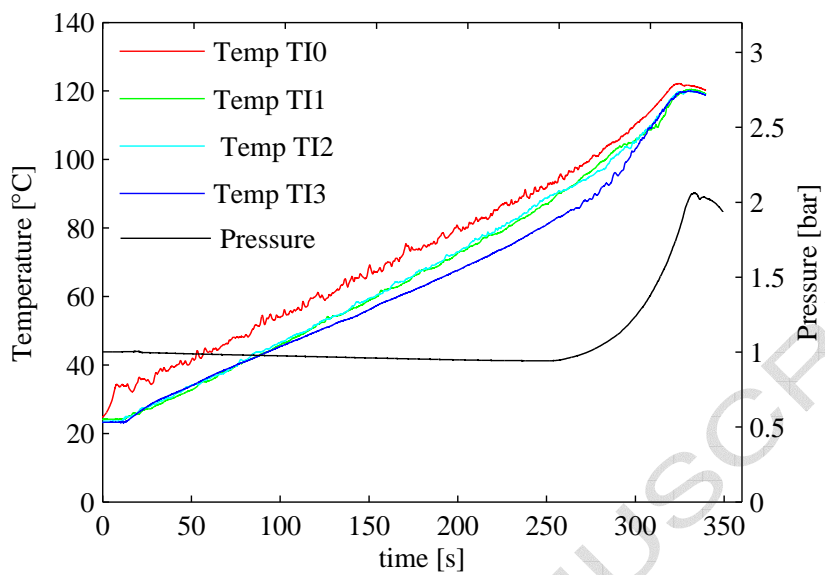

(a)

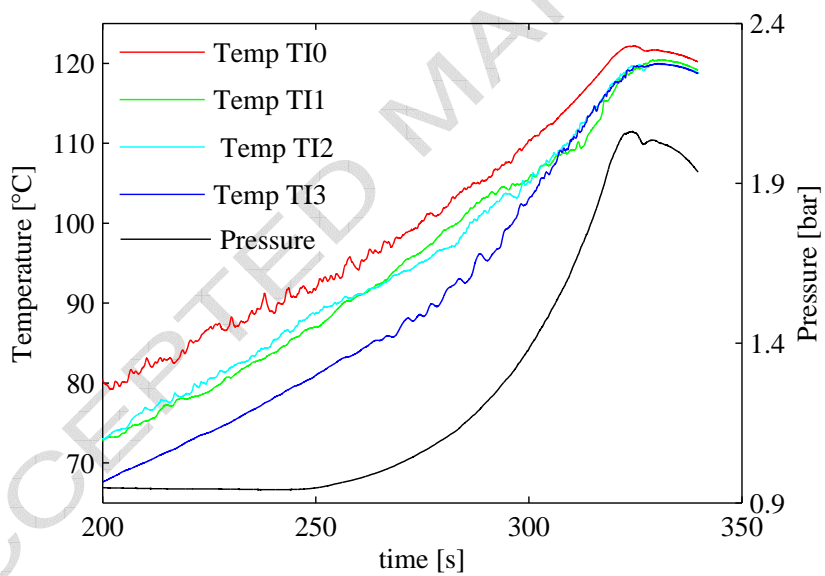

(b)

Fig. 3. In-tank temperature histories: a) whole experiment; b) detailed view of the late phase of extraction.

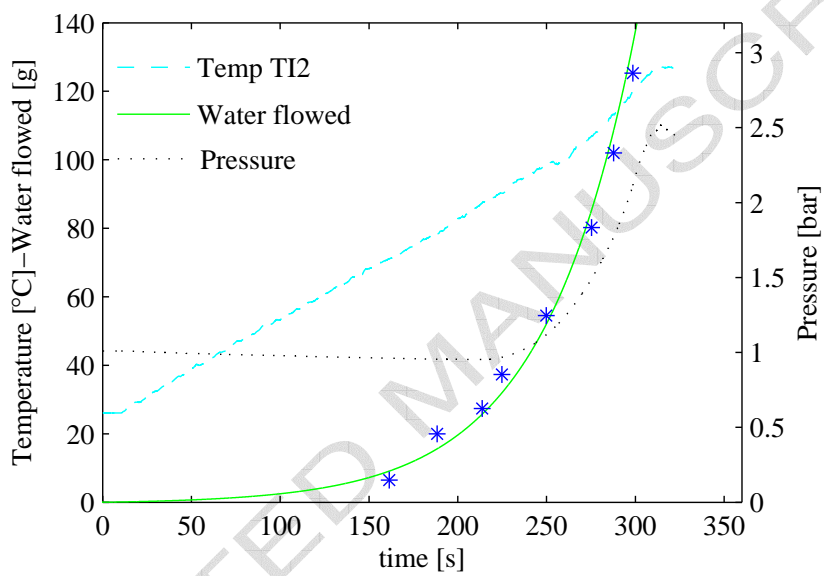

Fig. 4. In-tank temperature, pressure, and water flowed

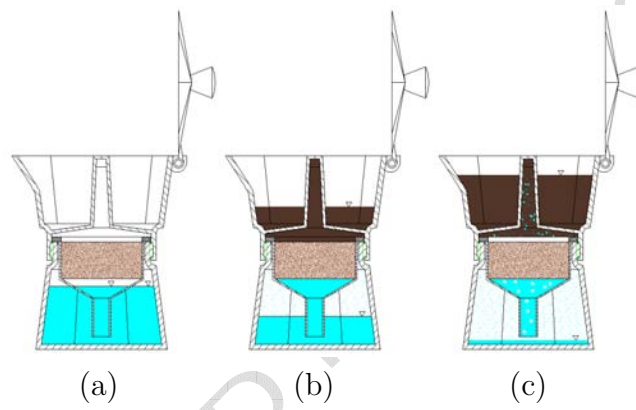

Fig. 5. extraction phases: a) beginning; b) regular extraction; c) strombolian extraction

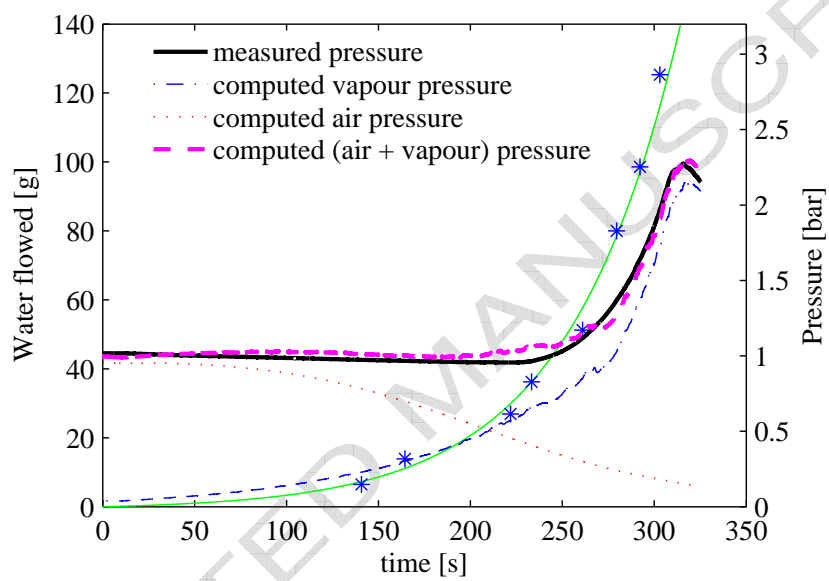
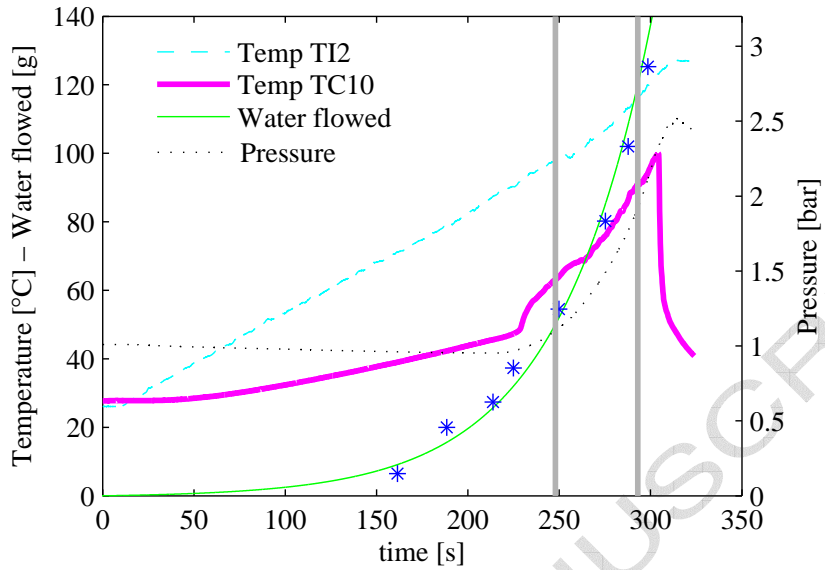
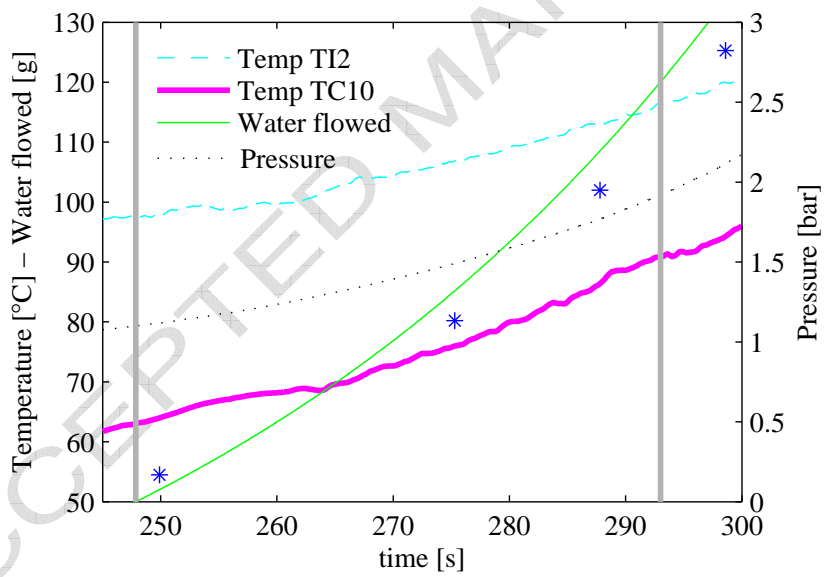

Fig. 6. Pressure contribution of dry air and saturated vapour



(a)



(b)

Fig. 7. a) Aqueous extract temperature at the exit of the coffee bed; b) detailed view

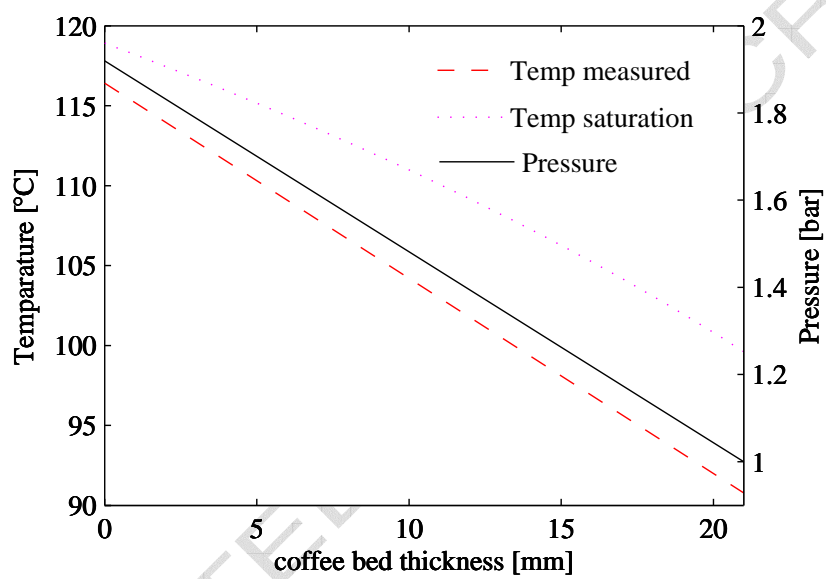

Fig. 8. Temperature profiles in the coffee bed at 120 g of water flowed

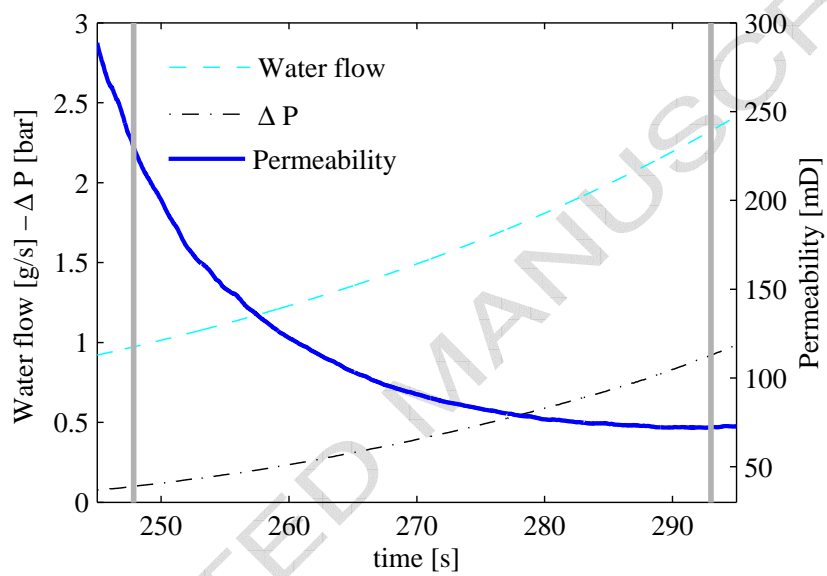

Fig. 9. Time varying permeability profile