



**HAL**  
open science

## Demagnetization of terrestrial and extraterrestrial rocks under hydrostatic pressure up to 1.2GPa

Natalia S. Bezaeva, Jérôme Gattacceca, Pierre Rochette, Ravil A. Sadykov,  
Vladimir I. Trukhin

► **To cite this version:**

Natalia S. Bezaeva, Jérôme Gattacceca, Pierre Rochette, Ravil A. Sadykov, Vladimir I. Trukhin.  
Demagnetization of terrestrial and extraterrestrial rocks under hydrostatic pressure up to 1.2GPa.  
Physics of the Earth and Planetary Interiors, 2010, 179 (1-2), pp.7. 10.1016/j.pepi.2010.01.004 .  
hal-00616881

**HAL Id: hal-00616881**

**<https://hal.science/hal-00616881v1>**

Submitted on 25 Aug 2011

**HAL** is a multi-disciplinary open access archive for the deposit and dissemination of scientific research documents, whether they are published or not. The documents may come from teaching and research institutions in France or abroad, or from public or private research centers.

L'archive ouverte pluridisciplinaire **HAL**, est destinée au dépôt et à la diffusion de documents scientifiques de niveau recherche, publiés ou non, émanant des établissements d'enseignement et de recherche français ou étrangers, des laboratoires publics ou privés.

## Accepted Manuscript

Title: Demagnetization of terrestrial and extraterrestrial rocks under hydrostatic pressure up to 1.2 GPa

Authors: Natalia S. Bezaeva, Jérôme Gattacceca, Pierre Rochette, Ravil A. Sadykov, Vladimir I. Trukhin

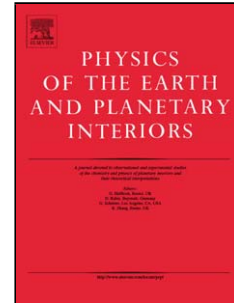

PII: S0031-9201(10)00007-5  
DOI: doi:10.1016/j.pepi.2010.01.004  
Reference: PEPI 5238

To appear in: *Physics of the Earth and Planetary Interiors*

Received date: 14-5-2009  
Revised date: 9-12-2009  
Accepted date: 8-1-2010

Please cite this article as: Bezaeva, N.S., Gattacceca, J., Rochette, P., Sadykov, R.A., Trukhin, V.I., Demagnetization of terrestrial and extraterrestrial rocks under hydrostatic pressure up to 1.2 GPa, *Physics of the Earth and Planetary Interiors* (2008), doi:10.1016/j.pepi.2010.01.004

This is a PDF file of an unedited manuscript that has been accepted for publication. As a service to our customers we are providing this early version of the manuscript. The manuscript will undergo copyediting, typesetting, and review of the resulting proof before it is published in its final form. Please note that during the production process errors may be discovered which could affect the content, and all legal disclaimers that apply to the journal pertain.

# 1 Demagnetization of terrestrial and extraterrestrial rocks under hydrostatic 2 pressure up to 1.2 GPa

3 Natalia S. Bezaeva <sup>a,b\*</sup>, Jérôme Gattacceca <sup>a</sup>, Pierre Rochette <sup>a</sup>, Ravil A. Sadykov <sup>c,d</sup> and  
4 Vladimir I. Trukhin <sup>b</sup>

5 <sup>a</sup> CEREGE, CNRS/Aix-Marseille Université, BP 80, 13545, Aix en Provence, Cedex 4, France

6 <sup>b</sup> Faculty of Physics, M.V. Lomonosov Moscow State University, Leninskie gory, 119991, Moscow, Russia

7 <sup>c</sup> Institute for Nuclear Research, Russian Academy of Sciences, 60-let Oktyabrya pr. 7a, 117312, Moscow, Russia.

8 <sup>d</sup> Institute for High Pressure Physics, Russian Academy of Sciences, Kaluzhskoye sh. 14, 142190, Troitsk, Russia

9

## 10 Abstract

11 We carried out hydrostatic pressure demagnetization experiments up to 1.24 GPa on samples of terrestrial and  
12 extraterrestrial rocks and minerals of different lithologies as well as on synthetic samples. The magnetic remanence  
13 of samples was measured directly under pressure using a non-magnetic high pressure cell of piston-cylinder type  
14 that was inserted into a high sensitivity SQUID magnetometer. In order to bring light on the pressure  
15 demagnetization effect, we investigated 50 samples with different magnetic mineralogies, remanent coercivities ( $B_{cr}$ )  
16 and hysteresis parameters. The samples consisted of pyrrhotite-, magnetite- and titanomagnetite-bearing Martian  
17 meteorites, taenite-, tetrataenite and kamacite-bearing ordinary chondrites and pyrrhotite-bearing Rumuruti  
18 chondrite; magnetite- and titanomagnetite-bearing basalts, andesites, ignimbrites, obsidians and granites; a variety of  
19 pyrrhotite- and hematite-bearing rocks and minerals (jasper, schist, rhyolite, radiolarite); samples of goethite and  
20 greigite as well as synthetic samples of dispersed powders of magnetite, hematite, pyrrhotite and native iron set into  
21 epoxy resin. Under hydrostatic pressure of 1.24 GPa, applied in a low magnetic field ( $<5\mu\text{T}$ ), the samples lost up to  
22 84% of their initial saturation isothermal remanent magnetization (SIRM) without any changes in their intrinsic  
23 magnetic properties. We found that the efficiency of the pressure demagnetization is not exclusively controlled by  
24 the magnetic hardness of the samples ( $B_{cr}$ ), but that it is strongly dependent on their magnetic mineralogy. For a  
25 given magnetic mineralogy the resistance to hydrostatic pressure is roughly proportional to  $\ln(B_{cr})$ . It was shown that  
26 there is no simple equivalence between pressure demagnetization and alternating field demagnetization effects. The

---

\* Corresponding author. Tel.: +7-4959393848; fax: +7-4959394881. *E-mail addresses*: bezaeva@physics.msu.ru (N.S. Bezaeva), gattacceca@cerege.fr (J. Gattacceca), rochette@cerege.fr (P. Rochette), rsadykov@inr.ru (R.A. Sadykov), trukhin@phys.msu.ru (V.I. Trukhin).

27 pressure demagnetization was shown to be time-independent but repeated application of the same pressure level  
28 resulted in further demagnetization.

29

30 *Keywords:* Pressure demagnetization; Hydrostatic pressure; Remanent magnetization; Rock magnetism

31

## 32 **1. Introduction**

33

34 Hypervelocity impacts are a major mechanism for the evolution of the solid matter in our  
35 solar system. Shock waves generated during impacts can modify both intrinsic magnetic  
36 properties (Gattacceca et al., 2007a; Louzada et al., 2007; Nishioka et al., 2007; Gilder et al.,  
37 2008) and remanent magnetization (Pohl, 1975; Kletetschka et al., 2004; Gattacceca et al., 2006,  
38 2008; Louzada et al., 2007) of rocks. Consequently, the magnetic record of solid bodies in the  
39 solar system, affected by impacts to different degrees, could have been erased or overprinted by  
40 shock events. Understanding the process and the physical mechanism of the impact  
41 remagnetization is therefore a key issue to the interpretation of the crustal magnetization of Mars  
42 (Hood et al., 2003, 2009), the Moon (Cisowski et al., 1976; Halekas et al., 2002, 2003), small  
43 solid solar system bodies such as asteroids (Chen et al., 1995) as well as paleomagnetic records  
44 of meteorites and extraterrestrial materials available from sample return. Concerning the Earth,  
45 shock-induced changes in rock magnetic properties and magnetic remanence should be taken  
46 into consideration while studying the remanent magnetism of terrestrial impacts (Halls, 1979;  
47 Pesonen et al., 1992; Pilkington and Grieve, 1992; Louzada et al., 2008).

48 Different authors have carried out experimental investigations of shock demagnetization  
49 (remagnetization) of rocks and pure minerals in the 1-30 GPa peak pressure range. Different  
50 techniques have been used for shock waves generation: air or gas gun accelerating aluminium or  
51 copper projectiles (Hornemann et al., 1975; Pohl et al., 1975; Martelli and Newton, 1977;  
52 Cisowski and Fuller, 1978; Srnka et al., 1979; Dickinson and Wasilewski, 2000; Louzada et al.,  
53 2007); high explosive and nuclear charges (Hargraves and Perkins, 1969; Pesonen et al., 1997;

54 Gattacceca et al., 2007a); free falling mass (Kletetschka et al., 2004) and pulsed laser  
55 (Gattacceca et al., 2006, 2008). The main caveats of such experiments are the complexity of  
56 dynamic pressure calibration, the possible mechanical damages of investigated samples, and  
57 deciphering of the effect of deviatoric versus hydrostatic stresses. Indeed, it is known that  
58 remanent magnetization is more sensitive to non-hydrostatic (deviatoric) than hydrostatic  
59 stresses (Nagata, 1966; Martin and Noel, 1988). Moreover, shock may permanently modify the  
60 intrinsic magnetic properties (e.g., coercivity, see Gattacceca et al., 2007a) thus complicating the  
61 interpretation.

62 As for meteorites, considering the relative rarity of extraterrestrial material on the Earth,  
63 it is excluded for most of them to perform shock experiments that are not only destructive but  
64 also require rather large sample volume. Numerous parameters must be considered when  
65 studying the effect of shock on the magnetic remanence: shock intensity and duration,  
66 background magnetic field during the shock event, magnetic mineralogy, pre-shock  
67 magnetization and temperature. This large number of parameters, that are sometimes difficult to  
68 control, complicates the comprehension of shock effect on rock magnetic remanence.

69 Static pressure experiments are well suited to tackle these problems. They allow better  
70 pressure calibration and can be non-destructive for samples. However, they were until recently  
71 limited to the low pressure range for under pressure measurements ( $<0.1$  GPa, e.g., Pozzi, 1973).  
72 Experiments were also carried out by pressurizing the sample up to 2 GPa, and remeasuring the  
73 remanence outside the pressurizing device (Pearce and Karson, 1988). More recently Rochette et  
74 al. (2003) compressed a pyrrhotite sample up to 3 GPa in a piston-cylinder press and remeasured  
75 isothermal remanent magnetization (IRM) after pressure release. It was found that pyrrhotite  
76 undergoes a high pressure magnetic transition under a pressure of 2.8 GPa, which results in a  
77 complete loss of its magnetic remanence. This experimental scheme has the disadvantage of  
78 needing a new sample and few days of experiments per each pressure value. Moreover, these  
79 experiments, by using a solid confining media, generate some deviatoric stress on the sample.

80 Gilder et al. (2006) performed IRM measurements of pure single domain (SD) and  
81 multidomain (MD) magnetite under quasihydrostatic load up to 4.2 GPa using a diamond anvil  
82 non-magnetic cell (in the Earth's magnetic field) and also observed a pressure demagnetization  
83 effect. Gilder and Le Goff (2008) carried out pressure experiments up to 6 GPa using a  
84 moissanite anvil cell on natural and synthesized MD titanomagnetite with different titanium  
85 concentration, but this work was focused upon the influence of stress on the acquisition of IRM.  
86 All these experiments are restricted to pure strongly magnetic minerals due to the minute sample  
87 size (e.g., for the diamond anvil cell the cylindrical sample chamber was 400  $\mu\text{m}$  in diameter and  
88 100  $\mu\text{m}$  in height) and cannot be realized on bulk rock samples without extracting their magnetic  
89 fraction.

90 Pressure demagnetization experiments on bulk rock samples have significant implications  
91 in solid-state physics and geophysics, in particular in paleomagnetism and interpretation of  
92 crustal magnetic anomalies of the solid Solar System bodies. As crustal rocks suffer the load  
93 created by overlying rocks and/or water column (for instance  $\sim 0.06$  GPa for 5 km of water and  
94 350 m of sediments), laboratory studies of the effect of pressure on the remanent magnetism of  
95 rocks may be helpful for the comprehension and interpretation of the paleomagnetic signal of the  
96 deep seated rocks and crustal magnetic anomalies. However, together with pressure, crustal  
97 rocks undergo the concomitant influence of high temperatures, making the situation even more  
98 complex. At pressures up to 1.5 - 2 GPa, which corresponds to a crustal thickness of 50-70 km,  
99 titanomagnetites do not crystallize any more (Valeev, 1984): this is the upper limit of relevant  
100 pressures.

101 Despite previous works, the effect of pressure on the remanent magnetization is still  
102 poorly known for natural materials for pressures of the order of 1 GPa. The goal of this work is  
103 to present a thorough investigation of the effect of hydrostatic pressure up to 1.24 GPa on the  
104 magnetic remanence of rocks within a wide range of magnetic mineralogies. We investigated 50  
105 samples of terrestrial and extraterrestrial rocks and minerals as well as synthetic samples with the

106 following magnetic carriers: magnetite, titanomagnetite, hematite, pyrrhotite, native iron and  
107 nickel iron, goethite, greigite. For each magnetic mineralogy we studied different samples  
108 spanning a wide range of remanent coercivity ( $B_{cr}$ ).

109

## 110 **2. Samples and Measuring Techniques**

### 111 *2.1. Experimental Setup*

112

113 In order to isolate the pressure demagnetization effect on rock magnetic remanence from  
114 the creation of piezo-remanent magnetization after pressure application (studied in many  
115 previous works, e.g., Nagata, 1966; Kinoshita, 1968; Pozzi, 1973) we always applied the  
116 pressure in a low magnetic field ( $<5 \mu\text{T}$ ).

117 The experimental setup was designed for room temperature measurements of magnetic  
118 remanence of relatively large rock samples (up to 5.8 mm in diameter and 15 mm long cylinders)  
119 under hydrostatic pressure up to 1.24 GPa. We used a non-magnetic composite high-pressure cell  
120 of piston-cylinder type with an inner diameter of 6 mm allowing direct measurement in a SQUID  
121 magnetometer (Fig.1). The cell was made of titanium alloy and “Russian alloy” ( $\text{Ni}_{57}\text{Cr}_{40}\text{Al}_3$ ).  
122 Samples were placed into a teflon capsule locked with a teflon plug and filled with inert  
123 polyethylsiloxane (PES-1) liquid allowing converting the uniaxial pressure on the pistons into a  
124 pure hydrostatic pressure (Kirichenko et al. 2005). Pressure inside the cell was calibrated with a  
125 manganin pressure sensor. Details of the cell design can be found in Sadykov et al. (2008).

126 After loading of the cell with a press (Graseby Specac 15011), pressure was locked inside  
127 the cell. The press with the cell inside was placed at the center of three pairs of perpendicular  
128 Helmholtz coils connected to stabilized DC supplies. Due to the presence of mobile metallic  
129 parts in the press, it was not possible to obtain a stable very low ambient field. The magnetic  
130 field in the area of the investigated sample was monitored using a 3 axis flux-gate magnetometer  
131 and was always below  $5 \mu\text{T}$ . Measurements of the magnetic moment of the sample under

132 pressure were performed by inserting the pressure cell containing the sample in a 2G Enterprises  
133 SQUID magnetometer. This magnetometer allowed measuring the remanent magnetic moment  
134 up to  $10^{-4} \text{ Am}^2$  with a noise level of  $10^{-11} \text{ Am}^2$ .

135 We investigated the intensity and stability of the magnetic remanence of the cell itself  
136 without and under pressure. The remanent magnetic moment of the cell remained stable at  $3 \cdot 10^{-8}$   
137  $\text{Am}^2$  at zero pressure and up to  $5 \cdot 10^{-8} \text{Am}^2$  under pressure in the pressure range 0 to 1.24 GPa,  
138 after 5-10 min of relaxation in a magnetically shielded room (ambient field  $\sim 100 \text{ nT}$ ). All  
139 measurements of magnetic remanence under pressure presented in this work were performed  
140 after 5-10 min of cell relaxation inside the SQUID magnetometer (ambient field 1-2 nT).

141 In this study the remanence of the investigated samples was always at least one order of  
142 magnitude above the remanence of the cell. In most cases, the samples were given a saturation  
143 isothermal remanent magnetization (SIRM) in a 3 T magnetic field (9 T for goethite, greigite and  
144 hematite-bearing samples) by using a pulse magnetizer MMPM9 from Magnetic Measurements  
145 Ltd. before pressure application. A few pressure demagnetization experiments were carried out  
146 on a laboratory imparted thermoremanent magnetization (TRM) or a natural remanent  
147 magnetization (NRM). The pressure was increased stepwise (8 steps up to 1.24 GPa) and the  
148 remanence was measured after each step. The pressure was then released down to zero and the  
149 remanence measured again. The specimen was then extracted from the pressure cell and its  
150 residual remanence ( $\text{IRM}_{\text{PR}}$ ) was demagnetized by alternating field (AF) up to 150 mT and  
151 measured using the same cryogenic magnetometer. The sample was then saturated again and was  
152 demagnetized by AF. All these measurements were carried out at room temperature.

153 In some cases the maximum pressure (1.24 GPa) was applied and released several times  
154 to check for the effect of repeated loading on the magnetic remanence. In most cases in addition  
155 to all the above described measurements, AF demagnetization curves of SIRM before  
156 compression were also measured. In our experiments pressure application did not produce any  
157 mechanical destruction of the investigated samples.



158 Before and after pressure application the investigated samples were subjected to standard  
159 magnetic analyses. Measurements of low field magnetic susceptibility  $\chi_0$  and thermomagnetic  
160 curves up to 700 °C were performed with KLY2-CS2 and MFK1-CS3 Agico apparatus (we used  
161 different subsamples for heating experiments). Hysteresis loops at room temperature and  
162 remanence measurements were obtained with a Micromag Vibrating Sample Magnetometer  
163 (VSM) with maximum applicable magnetic field 1 T. Curie temperatures ( $T_C$ ) of the investigated  
164 samples were obtained from thermo magnetic curves. For titanomagnetite-bearing samples  
165 substitution rate (ulvospinel content  $x$ ) was estimated using the corresponding  $T_C$  values  
166 according to Hunt et al. (1995).

167

## 168 2.2. Description of Samples

169

170 Pressure demagnetization experiments were carried out on samples of meteorites,  
171 terrestrial rocks and minerals as well as synthetic samples with the most common magnetic  
172 carriers (titanomagnetite  $\text{Fe}_{3-x}\text{Ti}_x\text{O}_4$ ; magnetite  $\text{Fe}_3\text{O}_4$ ; hematite  $\text{Fe}_2\text{O}_3$ ; pyrrhotite  $\text{Fe}_{1-x}\text{S}$ ; goethite  
173  $\text{FeOOH}$ ; greigite  $\text{Fe}_3\text{S}_4$ ; kamacite  $\sim\text{Fe}_{0.9}\text{Ni}_{0.1}$ ; taenite  $\sim\text{Fe}_{0.7}\text{Ni}_{0.3}$ ; tetrataenite  $\sim\text{Fe}_{0.5}\text{Ni}_{0.5}$ ). The  
174 main magnetic properties of the investigated samples are presented in Table 1.

175 We investigated Martian meteorites - (Bezaeva et al., 2007) NWA 998 nakhlite and Los  
176 Angeles and NWA 1068 basaltic shergottites, nickel iron-bearing ordinary chondrites - Bensor,  
177 Pultusk and Saratov - and a pyrrhotite-bearing Rumuruti chondrite NWA 753.

178 Regarding terrestrial rocks we investigated mostly igneous rocks: three types of andesites  
179 from Sardinia (Italy), *au1b* from Monte Au, *cug1b* from Monte Cugguruntis and *osb10b* from  
180 Monte Osilo, and five types of basalts: Pleistocene sample *ba* from the Bas-Vivarais area  
181 (France), Pleistocene alkaline sample *bb* from Chanteuges (Haute-Loire, France), Oligocene  
182 sample *be* from Ethiopian traps and two unshocked samples (*pd6-2-1*, *pd6-2-4*) from Lonar  
183 impact crater (Maharashtra state, India). We have also investigated a Pleistocene obsidian (*kil-2*)

184 from the Kilimandjaro volcano (Tanzania) as well as four granites from Corsica (France), five  
185 samples of ignimbrites (all from Sardinia, *iro8* from Monte Ironi and *mtd5b* from Monte Torru,  
186 *ona12* and *spi3301*, *spi3903* from San Pietro Island) and a sample of jasper (from San Pietro  
187 Island, Sardinia) as well as some samples of radiolarite from the French Alps, rhyolite from  
188 Esterel range (France) and Precambrian-Ordovician metamorphic schist from Wilson Terrane  
189 (Northern Victoria Land, Antarctica). We have also studied a natural hydrothermal fibrous  
190 goethite sample GT from Tarn (France) with only 0.42 wt.% of impurities (including 0.16%  
191 H<sub>2</sub>O; 0.12% SiO<sub>2</sub> and Ca, K, Ga for the >100 ppm elements, after Rochette et al. 2005b), and  
192 two samples of pyrrhotite from the Harvard Mineralogical Museum (Cambridge, USA):  
193 monocrystal *127037* from Chihauhau, Mexico and monocrystal *98080* from Sudbury (Canada).  
194 Two natural samples of SD greigite have also been investigated under pressure. Sample *greig-*  
195 *tw1* comes from the Plio-Pleistocene marine sediments from the Lower Gutingkeng Formation in  
196 southwestern Taiwan and sample *greig-it1* is from the upper Pliocene marine sediments from the  
197 Valle Ricca section near Rome, Italy.

198 Synthetic samples were in form of dispersed powders set into epoxy resin. Synthetic  
199 samples of monoclinic pyrrhotite had grain size  $x(\mu\text{m}) \in [75, 100]$  for sample *a* and  $x(\mu\text{m}) \in [150,$   
200  $250]$  for sample *b*. Synthetic samples of dispersed powders of magnetite with  $x < 25 \mu\text{m}$ , iron with  
201  $x = 10 \mu\text{m}$  and MD hematite were prepared using epoxy resin Araldite AY 103 by VANTICO.  
202 Different mass concentrations (0.3; 0.5; 0.8; 17%, see Table 1) of magnetite powder were used  
203 for the preparation of synthetic samples of magnetite in order to check whether the pressure  
204 resistance of magnetite is dependent on the magnetic interaction of grains. Mass concentration of  
205 synthetic samples of iron and hematite was of 2.5% and 2.1% respectively. For magnetite and  
206 iron we assume that clustering is not a serious issue as the grains are multidomain and stirring the  
207 viscous loaded resin should be sufficient to destroy magnetic aggregates. While magnetite and  
208 iron powders are commercial synthetic products, the hematite powder comes from a natural ore  
209 from Elba Island (Italy); the pyrrhotite samples are described in Dekkers (1988).

210 The typical mass for the investigated rock samples was in the 0.02 to 0.5 g range (Table  
211 1). As one can see from Table 1, we have investigated under pressure numerous samples with  
212 different magnetic mineralogies within a wide range of  $B_{cr}$  and grain sizes: from single domain,  
213 pseudosingle domain (PSD) to multidomain.

214

### 215 3. Experimental results

#### 216 3.1. Main characteristics of the pressure demagnetization experiments

217

218 The used pressure cell is characterised by a relatively low but nonzero remanent magnetic  
219 moment (see above). In order to check the need for correction of the magnetic remanence of  
220 investigated samples by the cell magnetic remanence, the sample of rhyolite (*rb7a*) was chosen.  
221 This sample is the better suited as it was shown to be the least magnetic (initial SIRM inside  
222 pressure cell is  $5.48 \cdot 10^{-7} \text{Am}^2$ ). Fig. 2 displays the evolution of the magnetic moment of the cell  
223 versus pressure (after 5, 10 and 15 min of the cell relaxation in the magnetically shielded room)  
224 as well as an uncorrected and vectorially corrected pressure demagnetization curves for *rb7a*  
225 sample. As one can see from Fig. 2, the correction in case of the least magnetic sample *rb7a*  
226 appears to be negligible. Therefore, pressure demagnetization curves for all other samples (with  
227 much higher magnetic remanence, see Table 2) were not corrected for the remanent magnetic  
228 moment of the cell.

229 The reproducibility of our pressure demagnetization experiments was tested in two  
230 different ways. Firstly, using exactly the same experimental protocol, we investigated under  
231 pressure the magnetic remanence of two subsamples of radiolarite (*radiol-1* and *radiol-2*) and  
232 two subsamples of Bensour meteorite (*Bensour-i* and *Bensour-j*) originated from the same bulk  
233 samples. The pressure demagnetization curves for the two radiolarite subsamples are very close  
234 (Fig. 3). The same holds for Bensour subsamples. The observed minor differences may come  
235 from sample heterogeneity as well as from the uncertainty on the applied pressure value.

236 Secondly, we used twice the same synthetic sample of dispersed powder of magnetite set into  
237 epoxy resin (sample *magn6c*, see Table 1) for two successive pressure demagnetization  
238 experiments with an identical experimental protocol. The identical pressure demagnetization  
239 curves further demonstrate the reproducibility of our experiments.

240 As mentioned above (see 2.1), we used the eight-step experimental protocol in the  
241 pressure range 0 to 1.24 GPa (see Fig. 4a-f). Several experiments were carried out in order to  
242 check the possible influence of the chosen experimental protocol (number of pressure steps up to  
243 the maximum pressure) on the final pressure demagnetization effect. Figure 5 displays the one-  
244 step pressure demagnetization curves of SIRM of microdiorite up to 0.31, 0.62, 0.93 GPa and the  
245 eight-step pressure demagnetization curve up to 1.24 GPa. Each curve corresponds to a different  
246 microdiorite subsample. As seen from Fig. 5, the pressure demagnetization degree at a given  
247 pressure value  $p$  is not sensitive to the number of pressure steps up to  $p$ . This points to the  
248 additivity of partial pressure demagnetization, consistent with previous work (e.g., Pearce and  
249 Karson, 1981).

250 In order to show that in our experiments the pressure demagnetization effect is not  
251 dependent on the duration of pressure application, we carried out the following experiment on a  
252 sample of basalt *ba* (see Table 1). The sample was imparted an SIRM and was then put under  
253 0.93 GPa, which led to 48% decrease in its initial magnetic remanence. The sample was then left  
254 under pressure during eight days; no further decrease of its magnetic remanence was observed.  
255 Thus, we conclude that the efficiency of pressure demagnetization is not time-dependent.

256 Most pressure demagnetization experiments were carried out on magnetically saturated  
257 samples (SIRM). It is known that IRM is not equivalent to NRM or laboratory induced TRM in  
258 terms of coercivity spectrum (Dunlop and Özdemir, 1997). Therefore, these different types of  
259 remanence may not have the same pressure sensitivity. NRM is expected to be more pressure  
260 resistant than IRM and TRM as it is generally already partially demagnetized by viscous decay.  
261 We carried out pressure demagnetization experiment on IRM, NRM and laboratory induced

262 TRM of basalts (*ba* and *bb*). NRM was confirmed to be the most pressure resistant remanence  
263 (Fig. 6, sample *bb*). Our results also showed that in some cases IRM was more easily  
264 demagnetized by hydrostatic pressure than TRM (Fig. 6, sample *ba*), consistent with Avchyan  
265 (1967); but this is not a general result (see Fig. 6, sample *bb* and also Pohl et al., 1975).

266 Hydrostatic pressure of 1.24 GPa did not produce any changes in SIRM of our samples.  
267 For example, both AF demagnetization curves of initial (pre-compressed) SIRM and post-  
268 compression SIRM of granite sample *bf9804* are identical (Fig. 7). We do not observe any  
269 modification of the intrinsic magnetic properties (hysteresis parameters, low field magnetic  
270 susceptibility  $\chi_0$ ,  $B_{cr}$ ) for the pressure range used in this work, since these modifications occur for  
271 pressures above several GPa (Gattacceca et al., 2007a; Louzada et al., 2007; Nishioka et al.,  
272 2007). Therefore, the grains are not affected by irreversible changes in the crystalline structure.  
273 Thus, pressure demagnetization is more likely due to domain wall displacements (irreversible  
274 upon decompression). If so, domain walls are more likely reset by a new saturation, as for all  
275 investigated samples SIRM before compression was found to be identical to SIRM imparted  
276 after decompression.

277

### 278 3.2. Systematic study of the pressure demagnetization effect

279

280 Figure 4a to 4f displays curves of IRM under pressure, normalized to initial SIRM, versus  
281 pressure up to 1.24 GPa for all investigated samples. Corresponding AF demagnetization curves  
282 of SIRM up to 150 mT (peak alternating field) are presented in Fig. 4g to 4l.

283 As it was shown in Bezaeva et al. (2007) for the Martian meteorites case, pressure  
284 sensitivity of rocks is mainly controlled by their magnetic mineralogy. Therefore,  
285 demagnetization curves (Fig.4a-f) were grouped by magnetic mineralogies irrespective of sample  
286 type (natural or synthetic, terrestrial or extraterrestrial origin etc.).

287 The effect of permanent pressure demagnetization (decreasing remanence) was observed  
288 on all curves of remanent magnetization under pressure versus pressure except for the goethite  
289 sample that retains 100% of its initial SIRM under 1.24 GPa (Fig. 4b), followed by a minor  
290 decrease in remanent magnetization (2%) after sample decompression. This is coherent with  
291 regard to its very high  $B_{cr}$  value ( $>9$  T after Rochette et al., 2005b). On the other hand, the  
292 maximum value of pressure demagnetization was obtained for a MD magnetite-bearing  
293 microdiorite which lost 84% of its initial SIRM under 1.24 GPa (sample *est* in Table 2 where  $\Delta$   
294 is the percentage of demagnetization of the initial SIRM under 1.24 GPa).

295 Among the investigated pyrrhotite-bearing samples (Fig. 4a), PSD sample NWA 753  
296 (Rumuruti chondrite) was found to be the most pressure resistant and synthetic samples of  
297 dispersed PSD pyrrhotite powder (*pyr-a* and *pyr-b*) were shown to be the most pressure  
298 sensitive. The monocrystal of predominately SD pyrrhotite (sample 98080) has a non-linear  
299 behavior resulting in a sharp decrease of IRM above 1.1 GPa. This could be related to a high  
300 anisotropy of the sample (Louzada et al., 2009) or/ and the approach to the magnetic phase  
301 transition pressure. SD greigite samples lost 10% and 26% of their initial remanent  
302 magnetization under pressure, respectively.

303 In the group of hematite-bearing samples the most pressure sensitive was the synthetic  
304 sample of MD hematite that lost  $\Delta=58\%$  of its initial SIRM under pressure, much more than SD  
305 hematite sample ( $\Delta=38\%$ ), PSD rhyolite ( $\Delta=27\%$ ), and radiolarites or jasper ( $\Delta\in[30; 35]\%$ ). SD  
306 and MD hematite samples have the same provenance (see 2.2): fine grain fraction of SD  
307 hematite powder was obtained by crushing the corresponding MD hematite powder (natural ore).

308 In the group of iron- and nickel iron-bearing samples the synthetic MD iron sample was  
309 found to be the most pressure sensitive ( $\Delta=83\%$ ) while the tetrataenite-bearing samples (*Saratov*  
310 and *Bensour-j* meteorites) are very resistant to pressure ( $\Delta\sim 3\%$ ). It is interesting to mention that  
311 within the group of  $Fe_{1-y}Ni_y$ -bearing samples pressure demagnetization degree decreases almost

312 linearly with increasing Ni-content ( $y=0\%$  for pure iron,  $y\sim 10\%$  for kamacite,  $y\sim 30\%$  for taenite  
313 and  $y\sim 50\%$  for tetrataenite). Additional work is needed to confirm this observation.

314 In the group of titanomagnetite-bearing samples (Fig. 4d) we investigated samples with  
315 different ulvospinel content ( $x$ ) ranging from  $x=0.03$  (*ona12* and *spi3301*) to  $x=0.63$  (*kil-2*).  
316 Pressure sensitivity of titanomagnetites does not seem to be dependent on ulvospinel content  
317 alone. For instance, samples *pd6-2-4* and *au1b* have very different  $x$  values ( $x=0.42$  and  $x=0.09$ ,  
318 respectively) but have almost the same pressure demagnetization degree under 1.24 GPa.

319 The group of magnetite-bearing samples shows the most diversified pressure  
320 demagnetization behavior and the highest dispersion in  $\Delta$  under 1.24 GPa with values ranging  
321 from 5 to 84%. As seen from Fig.4e-f, some pressure demagnetization curves are almost  
322 indistinguishable (e.g., samples *bf8703*, *NWA 998* and *iro8*), in agreement with their similar  
323 grain size (PSD, see Table 1) and magnetic hardness ( $B_{cr} \in [41, 61]$  mT). Their different  
324 geological origin (*bf8703* is a granite and *iro8* is an ignimbrite and *NWA 998* is a mafic  
325 cumulate) does not seem to play any significant role with respect to pressure sensitivity.

326 The values of median destructive field ( $MDF_i$  in mT) and median destructive stress  
327 (MDS in GPa) of SIRM, needed to remove one half of the initial SIRM by alternating field and  
328 by pressure, respectively, are presented in Tables 1-2. Most of MDS values were obtained by  
329 linear extrapolation of the linear parts of pressure demagnetization curves. Such values are  
330 indicated in italic in Table 2. This computation assumes that pressure demagnetization curves  
331 above 1.24 GPa remain linear, and that the samples do not undergo any phase transitions at  
332 pressures lower than MDS. It is not the case for pyrrhotite that undergoes a high-pressure  
333 magnetic transition and loses 100% of its remanence at about 2.8 GPa (Rochette et al., 2003). On  
334 average, hematite-bearing samples have the lowest MDS values situated in 1.1 to 2.3 GPa range  
335 (see Table 2).

336 As it is seen from Fig.4, there is a variety of behaviors with respect to pressure  
 337 demagnetization. In order to characterize different shapes of pressure demagnetization curves we  
 338 introduced the following coefficient:

$$339 \quad \alpha = [(SIRM_0 - IRM_{p_1}) / (SIRM_0 - IRM_{p_2})] / [p_1 / p_2] \quad (1)$$

340 where  $SIRM_0$  is the initial SIRM of the sample in the pressure cell before pressure application,  
 341  $IRM_{p_1}$  is IRM under  $p_1=0.46$  GPa and  $IRM_{p_2}$  is IRM of the sample under  $p_2=1.24$  GPa. Pressure  
 342 demagnetization curve has concave shape if  $\alpha > 1$ , convex shape if  $\alpha < 1$  and linear shape if  
 343  $\alpha \approx 1$ . As seen from Table 2 and Fig.4, pressure demagnetization curves of magnetite- and  
 344 titanomagnetite-bearing sample have mostly linear or concave shapes (average  $\alpha=1.4$  for  
 345 titanomagnetites and 1.5 for magnetites) whereas those of pyrrhotites (except synthetic samples  
 346 *pyr-a* and *pyr-b*) have slightly convex shape (average  $\alpha=0.8$  without considering synthetic  
 347 pyrrhotites) due to the existence of a 2.8 GPa phase transition (Rochette et al., 2003). Curves for  
 348 nickel iron-bearing meteorites have both concave and convex shapes and those for hematite-  
 349 bearing samples have mostly concave or linear shapes (with average  $\alpha=1.4$ ).

350 For iron a high pressure ferromagnetic to paramagnetic phase transition is known to take  
 351 place at 13 GPa (e.g., Dickinson and Wasilewski, 2000): at this pressure point  $\alpha$ -iron (body-  
 352 centered cubic structure) is transformed into  $\epsilon$ -iron (hexagonal close packed structure), which is  
 353 known to be non-magnetic. In our study pressure demagnetization curve for the sample of  
 354 synthetic iron has strongly concave shape; furthermore the sample has already lost up to 83% of  
 355 its initial SIRM under 1.24 GPa. Therefore, an iron sample will most likely lose 100% of its  
 356 magnetic remanence far below 13 GPa without undergoing any magnetic phase transition.

357

#### 358 4. Discussion

359

360 In order to check the effect of repeated load (to the same pressure level) on the magnetic  
 361 remanence, several cycles from 0 to 1.24 GPa were carried out on some of investigated sample



362 (see Fig. 8). Throughout repeated loads the remanent magnetization under pressure (Fig. 8a) or  
 363 upon pressure release (Fig. 8b) always shows a slight decrease as a function of number of cycles,  
 364 consistent with previous works (e.g., Pozzi, 1975; Gilder et al., 2006; Bezaeva et al., 2007). This  
 365 is not linked to a longer application of maximum pressure as it was shown above (see 3.1) that  
 366 hydrostatic pressure demagnetization effect is time-independent.

367 Contrary to the repeated application of the same pressure demagnetization step, repeated  
 368 application of the same alternating field demagnetization step does not produce a further  
 369 demagnetization effect of magnetic remanence. This shows that pressure demagnetization and  
 370 alternating field demagnetization have different physical nature and can not be directly compared  
 371 in terms of process. Samples that have similar alternating field demagnetization behavior of  
 372 SIRM can have very different pressure demagnetization behavior (e.g., samples *spi3301* and *bb*,  
 373 see Fig. 4d, 4j; or samples *bf3201* and *est*, see Fig. 4e, 4k). Therefore, it is not possible to link a  
 374 certain pressure value to AF value giving the same degree of demagnetization. AF demagnetizes  
 375 all grains with coercivities under a given value whereas pressure demagnetizes grains within a  
 376 large spectrum of coercivities. Moreover, the degree of demagnetization can vary over the  
 377 coercivity spectrum of a sample (Gattacceca et al., 2007a).

378 To represent how pressure demagnetization affects different coercivity fractions of the  
 379 IRM, we introduced in Bezaeva et al. (2007) the demagnetization loss  $\varepsilon$ :

$$380 \quad \varepsilon(B)=[IRM_B(B)-IRM_{BP}(B)]/IRM_B(B), \quad (2)$$

381 as a function of alternating field  $B$  (in mT).  $IRM_B$  and  $IRM_{BP}$  correspond to IRM values before  
 382 and after pressure application, respectively, so that  $IRM_B(B)$  is a curve of AF demagnetization of  
 383 initial SIRM and  $IRM_{BP}(B)$  is a curve of AF demagnetization of residual IRM after  
 384 decompression from 1.24 GPa ( $IRM_{PR}$ ). Curves of  $\varepsilon(B)$  for Martian meteorites (*NWA 1068*, *NWA*  
 385 *998*, *LA*), basalt *ba* and rhyolite *rb7a* were presented in Bezaeva et al. (2007, Fig. 3). Table 2  
 386 gives (in %) the values of  $\varepsilon_1=1-\varepsilon(B=30 \text{ mT})/\varepsilon(B=0 \text{ mT})$ , characterizing the shape of  $\varepsilon(B)$  curves.  
 387  $\varepsilon_1=0$  ( $\varepsilon_1=1$ ) if demagnetization affects only grains with coercivity below (above) 30 mT. In all

388 cases  $\varepsilon$  decreases with increasing AF, indicating that pressure preferentially demagnetizes the  
389 lower coercivity fractions (consistent with previous works, e.g., Pearce and Karson, 1981) but in  
390 some cases high coercivity fractions may also be affected. As seen from Table 2, the average  $\varepsilon_1$   
391 value for hematite-bearing samples is of  $(9\pm 4)\%$ , so mostly low coercivity fractions are affected  
392 by pressure demagnetization. For magnetite and titanomagnetite families high coercivity  
393 fractions (above 30 mT) are also affected: the average  $\varepsilon_1$  is of  $(69\pm 27)\%$  for magnetites and  
394  $(69\pm 10)\%$  for titanomagnetites. For pyrrhotite- and nickel iron-bearing samples average  $\varepsilon_1$  is of  
395  $(54\pm 23)\%$  and  $(53\pm 29)\%$ , respectively.

396 In most experiments pressure release resulted in further changes of the residual magnetic  
397 remanence comparing to the under-pressure level (1.24 GPa). Relative changes in magnetic  
398 remanence upon decompression ( $\delta$  in %) are presented in Table 2. Different magnetic  
399 mineralogies have different response to decompression resulting in either further increase  
400 (positive  $\delta$ ) of or further decrease (negative  $\delta$ ) in residual remanence (or, more rarely, no  
401 changes). An increase of residual IRM upon decompression was observed for pyrrhotite-bearing  
402 samples ( $1 < \delta < 8\%$ ) and hematite-bearing samples ( $0 < \delta < 9\%$ ). No significant effect was observed  
403 on metal, except for the sample of synthetic iron that shows 6% decrease in IRM after pressure  
404 release. Ti-rich and Ti-poor(free) magnetites seem to have different behavior of magnetic  
405 remanence upon decompression, so they were separated into two groups. Changes in magnetic  
406 remanence for Ti-free and Ti-poor magnetites (with  $0.03 \leq x \leq 0.09$ ) are in the range -7 to +6%;  
407 mostly decrease or negligible increase in remanence are observed apart for synthetic magnetites  
408 and *osb10b* sample. Titanomagnetites with high ulvospinel content ( $x > 0.4$ ) have generally higher  
409  $\delta$  (in the 2 to 19% range). Remarkably high  $\delta$  values are observed for *ba* and *kil-2* samples (13%  
410 and 19% recovery of magnetic remanence upon pressure release, respectively). It is interesting to  
411 note that both samples are characterized by the highest values of ulvospinel content between all  
412 investigated titanomagnetite-bearing samples.

413 The question of a key parameter that may be responsible for the pressure resistance of  
 414 different materials has already been put forward in previous works (Pearce and Karson, 1981;  
 415 Kletetschka et al., 2004). Pearce and Karson (1981) proposed a simple correlation between  
 416 coercivity and the effect of pressure demagnetization. Kletetschka et al. (2004) suggested that the  
 417 efficiency of pressure demagnetization is proportional to the logarithm magnetic coercivity ( $B_c$ ),  
 418 irrespective of magnetic mineralogy.

419 We have already shown that the pressure resistance of samples is tightly controlled by  
 420 their magnetic mineralogy (see above). By analyzing our experimental data, we concluded that  
 421 for a given magnetic mineralogy, the key proxy for sensitivity of samples to hydrostatic pressure  
 422 demagnetization is  $B_{cr}$  rather than  $B_c$ . Indeed, for each magnetic mineralogy pressure resistance  
 423 is roughly proportional to  $\ln(B_{cr})$  (Fig. 9). Synthetic samples of magnetite and iron were not  
 424 considered for this approximation; synthetic samples of hematite were taken into consideration  
 425 due to natural provenance of the used hematite powder (natural ore) (Fig. 9). Residual IRM  
 426 under pressure  $p_1=0.46$  GPa or  $p_2=1.24$  GPa, normalized to initial SIRM ( $IRM_p$ ), has been fitted  
 427 using the following equation:

$$428 \quad IRM_{px}/SIRM = a_x \cdot \ln(B_{cr}) + b_x, \quad (3)$$

429 where  $x=1$  for  $p_1$  and  $x=2$  for  $p_2$ ;  $a_x$  and  $b_x$  coefficients as well as linear correlation coefficients  $r_x$   
 430 between  $IRM_{px}/SIRM$  and  $B_{cr}$  (in mT) are given in Table 3. Strictly speaking  $B_{cr}$  value should be  
 431 dimensionless to equilibrate the equation (as the left part of the equation is dimensionless); this  
 432 can be easily reached by normalizing the  $B_{cr}$  value to 1 mT. Linear correlation coefficients  $r_x^*$   
 433 between  $IRM_{px}/SIRM$  and  $B_c$  (in mT) are also given in Table 3. Thus, based on the relative  
 434 values of  $r_x$  and  $r_x^*$  (see Table 3),  $B_{cr}$  appears to be a better proxy than  $B_c$  for all investigated  
 435 magnetic mineralogies: hematite, pyrrhotite, nickel iron, Ti-magnetite and magnetite, and both  
 436 pressure values ( $p_1$  and  $p_2$ ). This could be expected as magnetic remanence should be more  
 437 directly related to remanent rather than induced properties.

438 Coefficients of determination or  $R$ -squared values ( $R^2_x$ ) reflecting the confidence of a chosen  
 439 approximation were calculated for logarithmic (3) and linear approximations  
 440  $IRM_{px}/SIRM=f(B_{cr})$ . It was shown that  $R^2_x$  was always higher for logarithmic than for linear  
 441 approximation (except for pyrrhotite under  $p_1$ , where both logarithmic and linear approximations  
 442 have very low  $R$ -squared values).

443 The highest scatter is observed for magnetite and titanomagnetite-bearing samples (Fig.  
 444 9d), pointing to a complex behaviour of magnetic remanence versus pressure for this magnetic  
 445 mineralogy. In Fig. 10  $IRM_{p2}/SIRM$  is plotted versus  $M_{rs}/M_s$  for all natural magnetite- and  
 446 titanomagnetite-bearing samples.  $M_{rs}$  and  $M_s$  are saturation remanent and induced  
 447 magnetizations, respectively. As shown in Fig. 10, pressure demagnetization of (Ti-)magnetites  
 448 is controlled by both ulvospinel content (vertical shift of points on the graph) and magnetic  
 449 domain structure (horizontal shift of points on the graph). Three sample groups can be  
 450 delineated: samples with  $x \in [0; 0.1]$  (a); samples with  $x \in [0.40; 0.55]$  (b) and samples with  
 451  $x \geq 0.55$  (c). The last group is represented by only two samples (*LA* and *kil-2*). Samples from the  
 452 three groups lie along three separate trends. As it is seen from Fig. 10, pressure demagnetization  
 453 efficiency of magnetites and Ti-magnetites is clearly grain-size dependent and increases with  
 454 increasing grain size (decreasing  $M_{rs}/M_s$ ). Pressure demagnetization degree of MD magnetites in  
 455 our study is consistent with the results of Gilder et al. (2006), who showed that MD magnetite  
 456 retained 66% of its initial SIRM under 1.40 GPa. We did not investigate Ti-free SD magnetite  
 457 samples that would have allowed confirmation of the surprising result by Gilder et al. (2006) that  
 458 SD magnetite is more pressure sensitive than MD magnetite despite its higher  $B_{cr}$ .

459 Metal and Ti-free magnetite have the highest intrinsic pressure resistivity (after goethite),  
 460 but become much more pressure sensitive in their multidomain state. A synthetic graph for all  
 461 magnetic mineralogies under  $p_2=1.24$  GPa is presented in Fig. 11. The  $B_{cr}$  value corresponding to  
 462 the threshold, above which no further pressure demagnetization could be produced under 1.24  
 463 GPa (called  $B_{th}$ ), was determined for each magnetic mineralogy (Table 3). The highest value of

464  $B_{th}$  corresponds to hematite, which appears to be the most pressure sensitive material in  
465 agreement with the lowest MDS values found for hematite-bearing samples. Based on other  $B_{th}$   
466 values, magnetite and Ti-magnetite appear as pressure sensitive as nickel iron but more pressure  
467 resistant than pyrrhotite (in the coercivity window  $B_{cr}>33$  mT). Goethite was found to be the  
468 most pressure resistant mineral. Based on the two greigite samples, this mineral appears to be  
469 more sensitive to pressure than magnetite.

470

## 471 **5. Conclusions**

472

473 This study gives an overview of the sensitivity to pressure demagnetization (by a purely  
474 hydrostatic load up to 1.24 GPa) of geological and extraterrestrial materials as well as synthetic  
475 samples with a variety of magnetic mineralogies: magnetite and titanomagnetite, pyrrhotite,  
476 greigite, hematite, goethite as well as iron and iron-nickel alloys. Magnetic remanence under  
477 pressure and upon decompression was investigated using a non-magnetic high pressure cell of  
478 piston-cylinder type together with a high sensitivity remanence magnetometer (SQUID  
479 magnetometer).

480 After showing the good reproducibility of our experiments, we demonstrated the  
481 additivity of partial pressure demagnetization. It was found that under hydrostatic pressure of  
482 1.24 GPa, applied in a low magnetic field ( $<5$   $\mu$ T), rock and synthetic samples lost irreversibly  
483 up to 84% of their initial saturation isothermal remanent magnetization without any changes in  
484 their intrinsic magnetic properties. Decompression resulted in further changes in IRM (decrease  
485 or increase up to 19% with respect to the initial SIRM value before compression) but  
486 decompressed residual IRM never reached SIRM value before compression.

487 It was shown that hydrostatic pressure demagnetization is not time-dependent, but  
488 repeated application of the same pressure level leads to further demagnetization. The main factor  
489 controlling the stability of remanent magnetization versus hydrostatic pressure is magnetic  
490 mineralogy. For a given magnetic mineralogy the resistance to pressure is roughly proportional

491 to  $\ln(B_{cr})$ , where  $B_{cr}$  is the coercivity of remanence (reflecting the magnetic hardness of the  
492 sample).

493 Thus, based on our experimental investigations, we propose a phenomenological model  
494 allowing to quantify the pressure demagnetization effect (Fig. 11, Table 3): after identification of  
495 the main magnetic mineralogy of the sample and by measuring its  $B_{cr}$  value, it is possible to  
496 roughly estimate the resistance of its magnetic remanence to a purely hydrostatic load of 0.46  
497 and 1.24 GPa. For magnetite and titanomagnetite such a model must be refined by considering  
498 the magnetic domain state and the substitution rate  $x$  (Fig. 10). The pressure demagnetization  
499 effect was shown to be grain-size sensitive: the efficiency of pressure demagnetization typically  
500 increases with increasing grain size.

501

## 502 **Acknowledgements**

503

504 This work was supported by the French Agence Nationale de la Recherche (project 05-  
505 JCJC-0133) and was partially funded by the CNRS-RFFI PICS program (grant №07-05-92165)  
506 while the stay of N.S. Bezaeva at CEREGE was funded by a research grant of the French  
507 Government (№2005814). We acknowledge K.L. Louzada (Harvard University, Cambridge,  
508 USA) for providing basalt samples from the Lonar crater (PD6-2-1, PD6-2-4). C. Francis  
509 (Harvard Museum of Natural History, Cambridge, USA) is acknowledged for providing the  
510 pyrrhottite samples 98080 and 127037. We are grateful to B. Zanda (Museum National  
511 d'Histoire Naturelle, Paris, France) and M.A. Nazarov (Vernadsky Institute for Geochemistry  
512 and Analytical Chemistry RAS, Moscow, Russia) for providing some meteorite samples. We  
513 thank A.P. Roberts (University of Southampton, Southampton, UK) and A.R. Muxworthy  
514 (Imperial College of London, London, UK) for providing greigite samples.

515

## 516 **References**

- 517
- 518 Avchyan, G.M., 1967. Effect of hydrostatic pressure up to 8000 kg/cm<sup>2</sup> on various types of  
519 remanent magnetization of rocks (translated from Russian). *Izv. Phys. Solid Earth*, 7:  
520 465-469.
- 521 Bezaeva, N.S., Rochette, P., Gattacceca, J., Sadykov, R.A., Trukhin, V.I., 2007. Pressure  
522 demagnetization of the Martian crust: Ground truth from SNC meteorites. *Geophys. Res.*  
523 *Lett.*, 34: L23202, doi: 10.1029/2007GL031501.
- 524 Chen, G., Ahrens, T.J., Hide, R., 1995. Hypervelocity impacts and magnetization of small bodies  
525 in the solar system. *Icarus*, 115: 86-96.
- 526 Cisowski, S.M., Dunn, J.R., Fuller, M., YeeMing, Wu., 1976. Magnetic effects of shock and  
527 their implications for lunar magnetism (II). In: *Proc. Lunar Sci. Conf.* 7<sup>th</sup>: 3299-3320.
- 528 Cisowski, S.M., Fuller, M., 1978. The effect of shock on the magnetism of terrestrial rocks. *J.*  
529 *Geophys. Res.*, 83: 3441-3458.
- 530 Dekkers, M.J., 1988. Magnetic properties of natural pyrrhotite part 1: Behavior of initial  
531 susceptibility and saturation-magnetization related parameters in a grain-size dependent  
532 framework. *Phys. Earth Planet. Int.* 52: 376-393.
- 533 Dickinson, T. L., Wasilewski, P., 2000. Shock magnetism in fine particle iron. *Meteor. Planet.*  
534 *Sci.*, 35: 65-74.
- 535 Dunlop, D., Özdemir, O., 1997. *Rock Magnetism: Fundamentals and Frontiers*. Cambridge  
536 University Press, Cambridge, 573 pp.
- 537 Florindo, F., Sagnotti, L., 1995. Palaeomagnetism and rock magnetism in the upper Pliocene  
538 Valle Ricca (Rome, Italy) section. *Geophys. J. Int.*, 123: 340-354.
- 539 Gattacceca, J., Rochette, P., Bourot-Denise, M., 2003. Magnetic properties of a freshly fallen LL  
540 ordinary chondrite: the Bensour meteorite. *Phys. Earth Planet. Int.*, 140: 343-358.
- 541 Gattacceca, J., Orsini, J.-B., Bellot, J.-P., Henry, B., Rochette, P., Rossi, P., Cherchi, G., 2004.  
542 Magnetic fabric of granitoids from Southern Corsica and Northern Sardinia and

- 543 implications for Late Hercynian tectonic setting. *J. Geological Society, London*, 161:  
544 277-289.
- 545 Gattacceca, J., Boustie, M., Weiss, B., Rochette, P., Lima, E.A., Fong, L.E., Baudenbacher, F.J.,  
546 2006. Investigating impact demagnetization through laser impacts and SQUID  
547 microscopy. *Geology*, 34: 333-336, doi: 10.1130/G21898.1.
- 548 Gattacceca, J., Lamali, A., Rochette, P., Boustie, M., Berthe, L., 2007a. The effect of explosive-  
549 driven shocks on the natural remanent magnetization and the magnetic properties of  
550 rocks. *Phys. Earth Planet. Int.*, 162: 85-98.
- 551 Gattacceca, J., Deino, A., Rizzo, R., Jones, D.S., Henry, B., Beaudoin, B., Vadeboin, F., 2007b.  
552 Miocene rotation of Sardinia: New paleomagnetic and geochronological constraints and  
553 geodynamic implications. *Earth Planet Sci. Lett.*, 258: 359-377.
- 554 Gattacceca, J., Berthe, L., Boustie, M., Vadeboin, F., Rochette, P., De Resseguier, T., 2008. On  
555 the efficiency of shock magnetization processes. *Phys. Earth Planet. Int.*, 166: 1-10.
- 556 Gilder, S.A., Le Goff, M., Chevrin, J.-C., 2006. Static stress demagnetization of single and  
557 multidomain magnetite with implications to meteorite impacts. *High Pressure Research*,  
558 26: 539-547.
- 559 Gilder, S.A., Le Goff, M., 2008. Systematic pressure enhancement of titanomagnetite  
560 magnetization. *Geophys. Res. Lett.*, 35: L10302, doi: 10.1029/2008GL033325.
- 561 Halekas, J.S., Mitchell, D.L., Lin, R.P., Hood, L.L., Acuña, M.H., Binder, A.B., 2002.  
562 Demagnetization signatures of lunar impact craters. *Geophys. Res. Lett.*, 29: 23-1, doi:  
563 10.1029/2001GL013924.
- 564 Halekas, J.S., Lin, R.P., Mitchell, D.L., 2003. Magnetic fields of lunar multi-ring impact basins.  
565 *Meteor. Planet. Sci.*, 38: 565-578.
- 566 Halls, H.C., 1979. The State of Islands meteorite impact site: a study of shock remanent  
567 magnetization. *Geophys. J. R. Astr. Soc.*, 59: 553-591.



- 568 Hargraves, R.B., Perkins, W.E., 1969. Investigations of the effect of shock on natural remanent  
569 magnetism. *J. Geophys. Res.*, 74: 2576-2589.
- 570 Hood, L., Richmond, N.C., Pierazzo, E., Rochette, P., 2003. Distribution of crustal magnetic  
571 fields on Mars: shock effects of basin-forming impacts. *Geophys. Res. Lett.*, 30: doi:  
572 10.1029/2002GL016657.
- 573 Hood, L.L., Harrison, K.P., Langlais, B., Lillis, R.J., Poulet, F., and Williams, D.A. 2009.  
574 Magnetic anomalies near Apollinaris Patera and the Medusae Fossae Formation in Lucus  
575 Planum, Mars. *Icarus* (submitted).
- 576 Hornemann, U., Pohl J., Bleil, U., 1975. A compressed air gun accelerator for shock  
577 magnetization and demagnetization experiments up to 20 kbar. *J. Geophys.*, 41: 13-22.
- 578 Horng, C.-S., Torii, M., Shea, K.-S., Kao, S.-J., 1998. Inconsistent magnetic polarities between  
579 greigite- and pyrrhotite/ magnetite-bearing marine sediments from the Tsailiao-chi  
580 section, southwestern Taiwan. *Earth Planet. Sci. Lett.*, 164: 467-481.
- 581 Hunt, C.P., Moskowitz, B.M., Banerjee, S.K., 1995. Magnetic properties of rocks and minerals.  
582 In: T.J. Ahrens (Editor). *Rock Physics and Phase Relations: A Handbook of Physical*  
583 *Constants*, Am. Geophys. Union, Reference Shelf 3: 189-204.
- 584 Jiang, W.-T., Horng, C.-S., Roberts, A.P., Peacor, D.R., 2001. Contradictory magnetic polarities  
585 in sediments and variable timing of neof ormation of authigenic greigite. *Earth Planet.*  
586 *Sci. Lett.*, 193: 1-12.
- 587 Kinoshita, H., 1968. Studies on Piezo-Magnetization (III) PRM and Relating Phenomena. *J.*  
588 *Geomag. Geoelectr.*, 20: 155-167.
- 589 Kirichenko, A.S., Kornilov, A.V., Pudalov, V.M., 2005. Properties of polyethylsiloxane as a  
590 pressure-transmitting medium. *Instr. Experim. Tech.*, 48(6): 813-816, doi:  
591 10.1007/s10786-005-0144-5 (translated from Russian).
- 592 Kletetschka, G., Connerney, J.E.P., Ness, N.F., Acuña, M.H., 2004. Pressure effects on Martian  
593 crustal magnetization near large impact basins. *Meteorit. Planet. Sci.*, 39: 1839-1848.

- 594 Louzada, K.L., Stewart, S.T., Weiss, B.P., 2007. Effect of shock on the magnetic properties of  
595 pyrrhotite, the Martian crust and meteorites. *Geophys. Res. Lett.*, 34: L05204, doi:  
596 10.1029/2006GL027685.
- 597 Louzada, K.L., Weiss, B.P., Maloof, A.C., Stewart, S.T., Swanson-Hysell, N.L., Soule, S.A.,  
598 2008. Paleomagnetism of Lonar impact crater, India. *Earth Planet. Sci. Lett.*, 275: 308-  
599 319.
- 600 Louzada, K.L., Stewart, S.T., Weiss, B.P., Gattacceca, J., Bezaeva, N.S., 2009. Shock and Static  
601 Pressure Demagnetization of Pyrrhotite and Implications for the Martian Crust. *Earth  
602 Planet. Sci. Lett.* (accepted).
- 603 Martelli, G., Newton, G., 1977. Hypervelocity cratering and impact magnetization of basalt.  
604 *Nature*, 269: 478-480.
- 605 Martin, R.J., Noel, J.S., 1988. The influence of stress path on thermoremanent magnetization.  
606 *Geophys. Res. Lett.*, 15: 507-510.
- 607 Nagata, T., 1966. Main characteristics of piezo-magnetization and their qualitative interpretation.  
608 *J. Geomag. Geoelectr.*, 18: 81-97.
- 609 Nishioka, I., Funaki, M., Toshimori, S., 2007. Shock-induced anisotropy of magnetic  
610 susceptibility: impact experiment on basaltic andesite. *Earth Planets Space*, 59: e45–e48.
- 611 Pearce, G.W., Karson, J.A., 1981. On pressure demagnetization. *Geophys. Res. Lett.* 8: 725-728.
- 612 Pesonen, L.J., Marcos, N., Pipping, F., 1992. Palaeomagnetism of the Lappajärvi impact  
613 structure, western Finland, 216: 123-142.
- 614 Pesonen, L.J., Deutsch, A., Hornemann, U., Langenhorst, F., 1997. Magnetic properties of  
615 diabase samples shocked experimentally in the 4.5 to 35 GPa range. In: *Proc. Lunar  
616 Planet. Sci. Conf. 28<sup>th</sup>*: 1087-1088.
- 617 Pilkington, M., Grieve, R.A.F., 1992. The geophysical signature of terrestrial impact craters.  
618 *Rev. Geophys.*, 30: 161-181.

- 619 Pohl J., Bleil U., Hornemann U. 1975. Shock magnetization and demagnetization of basalt by  
620 transient stress up to 10 kbar. *J. Geophys.* 41: 23-41.
- 621 Pozzi, J.P., 1973. Effets de pression en magnétisme des roches, Ph.D Thesis, Université Paris VI,  
622 Paris, France.
- 623 Pozzi, J.P., 1975. Magnetic properties of oceanic basalts – effects of pressure and consequences  
624 for the interpretation of anomalies. *Earth Planet. Sci. Lett.*, 26: 337-344.
- 625 Rochette, P., Bertrand, H., Braun, C., Berger, E., 1993. La province volcanique Pléistocène  
626 supérieur du Bas-Vivarais (Ardèche, France): propagation de fentes crustales en  
627 échelons? *C.R. Acad. Sci. Paris*, 316: 913-920.
- 628 Rochette, P., Tamrat, E., Féraud, G., Pik, R., Courtillot, V., Ketefo, E., Coulon, C., Hoffmann,  
629 C., Vandamme, D., Yirgu, G., 1998. Magnetostratigraphy and timing of the Oligocene  
630 Ethiopian traps. *Earth Planet. Sci. Lett.*, 164: 497-510.
- 631 Rochette, P., Lorand, J.-P., Fillion, G., Sautter, V., 2001. Pyrrhotite and the remanent  
632 magnetization of SNC meteorites: a changing perspective on Martian magnetism. *Earth*  
633 *Planet. Sci. Lett.*, 190: 1-12.
- 634 Rochette, P., Fillion, G., Ballou, R., Brunet, F., Ouladdiaf, B., Hood, L., 2003. High pressure  
635 magnetic transition in pyrrhotite and impact demagnetization on Mars. *Geophys. Res.*  
636 *Lett.* 30: 1683, doi: 10.1029/2003GL017359.
- 637 Rochette, P., Gattacceca, J., Chevrier, V., Hoffmann, V., Lorand, J.-P., Funaki, M., Hochleitner,  
638 R., 2005a. Matching Martian crustal magnetization and magnetic properties of Martian  
639 meteorites. *Meteor. Planet. Sci.*, 40: 529-540.
- 640 Rochette, P., Mathe, P.-E., Esteban, L., Rakoto, H., Bouchez, J.-L., Liu, Q., Torrent, J., 2005b.  
641 Non-saturation of the defect moment of goethite and fine-grained hematite up to 57  
642 Teslas. *Geophys. Res. Lett.*, 32: L22309, doi: 10.1029/2005GL024196.
- 643 Rochette, P., Gattacceca, J., Bonal, L., Bourot-Denise, M., Chevrier, V., Clerc, J.-P.,  
644 Consolmagno, G., Folco, L., Gounelle, M., Kohout, T., Pesonen, L., Quirico, E.,

- 645 Sagnotti, L., Skripnik, A., 2008. Magnetic Classification of Stony Meteorites: 2. Non-  
646 Ordinary Chondrites. *Meteor. Planet. Sci.*, 43: 959-980.
- 647 Sadykov, R.A., Bezaeva, N.S., Kharkovskiy, A.I., Rochette, P., Gattacceca, J., Trukhin, V.I.,  
648 2008. Nonmagnetic high pressure cell for magnetic remanence measurements up to 1.5  
649 GPa in a superconducting quantum interference device magnetometer. *Rev. Sci. Instr.*,  
650 79: 115102, doi: 10.1063/1.2999578.
- 651 Srnka, L.J., Martelli, G., Newton, G., Cisowski, S.M., Fuller, M.D., Schaal, R.B., 1979.  
652 Magnetic field and shock effects and remanent magnetization in a hypervelocity impact  
653 experiments. *Earth Planet. Sci. Lett.*, 42: 127-137.
- 654 Valeev, K.A., 1984. Magnetic properties of rocks at high pressures and temperatures and the  
655 problem of magnetoactive layer of the Earth's crust and upper mantle. Thesis for a  
656 Doctor's degree, M.V. Lomonosov Moscow State University, Moscow, Russia (in  
657 Russian).
- 658 Van Dongen, B.E., Roberts, A.P., Schouten, S., Jiang, W-T., Florindo, F., Pancost, R.D., 2007.  
659 Formation of iron sulfide nodules during anaerobic oxidation of methane. *Geochim.*  
660 *Cosmochim. Acta*, 71: 5155–5167
- 661 Vlag, P., Vandamme, D., Rochette, P., Spinelli, K., 1997. Paleomagnetism in the Esterel rocks: a  
662 revisit 22 years after the thesis of H. Zijdeveld. *Geologie en Mijnbouw*, 76: 21-33.
- 663

664 **Figure captions:**

665

666 **Figure 1.** Scheme of assembled high pressure cell (cross-sectional view)

667 (a) with manganin pressure sensor (obturator) and (b) without obturator. All cell dimensions are  
 668 indicated in millimeters. *1*: wires, *2*: pusher, *3*: upper locking screw, *4*: obturator, *5*: antiextrusion  
 669 gaskets, *6*: manganin sensor (coil), *7*: teflon cavity, *8*: pressure transmitting medium (PES-1), *9*:  
 670 sample, *10*: fixing teflon spiral, *11*: lower locking screw, *12*: piston support, *13*: inner piston, *14*:  
 671 inner part in Russian alloy (NiCrAl), *15*: outer part in titanium alloy, *16*: pusher, *17*: piston  
 672 support, *18*: inner piston, *19*: antiextrusion gasket, *20*: teflon plug. Elements 2, 4, 12–13, and 16–  
 673 18 are made of Russian alloy while elements 3 and 11 are made of titanium alloy.

674

675 **Figure 2.** Example of correction of the pressure demagnetization curve of hematite-bearing  
 676 rhyolite (sample *rb7a*) by the magnetic moment of the pressure cell. The lower curves  
 677 correspond to the cell remanent magnetic moment  $M_r$  under pressure versus pressure after 5, 10  
 678 and 15 min of relaxation of the cell in a magnetically shielded room. The upper curves  
 679 correspond to the uncorrected (dashed line) and vectorially corrected (solid line) pressure  
 680 demagnetization curves (residual IRM under pressure versus pressure) of *rb7a*.

681

682 **Figure 3.** Residual isothermal remanent magnetization under pressure (normalized to initial  
 683 SIRM) versus pressure for two subsamples of radiolarite (*radiol-1* and *radiol-2*), originated from  
 684 the same initial sample; two subsamples of Bensour meteorite (*Bensour-i* and *Bensour-j*);  
 685 synthetic sample of magnetite powder set into epoxy resin (*magn6c*). Pressure experiments on  
 686 *magn6c* sample were carried out twice in order to check for the reproducibility of the pressure  
 687 demagnetization effect (curves *magn6a (1)* and *magn6c (2)*, respectively).

688

689 **Figure 4 (a-f):** Residual isothermal remanent magnetization under pressure (normalized to initial  
690 SIRM) versus pressure. Each curve corresponds to a different sample. **(g-l):** Alternating field  
691 (AF) demagnetization of normalized SIRM. Pressure demagnetization and AF demagnetization  
692 curves corresponding to the same sample are indicated by the same plot style and symbols. a)-g)  
693 pyrrhotite- and greigite-bearing samples, b)-h) hematite and goethite-bearing samples, c)-i) iron  
694 and nickel iron-bearing samples, d)-j) titanomagnetite-bearing samples, e),f)-k),l) magnetite-  
695 bearing samples.

696  
697 **Figure 5.** Residual isothermal remanent magnetization under pressure (normalized to initial  
698 SIRM) versus pressure for four different microdiorite subsamples, originated from the same  
699 initial sample.

700  
701 **Figure 6.** Residual remanent magnetization under pressure (normalized to its initial value of  
702 NRM, TRM or IRM) versus pressure. Each curve corresponds to a different sample.

703  
704 **Figure 7.** Alternating field (AF) demagnetization curves of initial SIRM, residual IRM after  
705 decompression from 1.24 GPa and SIRM acquired after decompression for a magnetite-bearing  
706 granite sample (*bf9804*). AF demagnetization curves of initial SIRM and SIRM after  
707 decompression are indistinguishable.

708  
709 **Figure 8.** (a) Residual remanent magnetization under 1.24 GPa versus number of compression  
710 cycles up to 1.24 GPa. (b) residual remanent magnetization upon decompression from 1.24 GPa  
711 versus number of compression cycles up to 1.24 GPa.

712  
713 **Figure 9.** Residual remanent magnetization (normalized to initial SIRM) under  $p_1=0.46$  GPa  
714 (open symbols) and  $p_2=1.24$  GPa (solid symbols) versus coercivity of remanence  $B_{cr}$  for (a)

715 pyrrhotite-bearing samples; (b) hematite-bearing samples; (c) nickel-iron bearing samples (the  
716 sample of synthetic iron is not considered); (d) magnetite- and titanomagnetite-bearing samples  
717 (synthetic samples of magnetite are not considered). Logarithmic approximation is indicated for  
718 each mineralogy (see also Table 3). The data points indicated by open and solid circles are not  
719 taken into account in the logarithmic fit: for nickel iron-bearing samples (c) because of the  
720 absence of further demagnetization effect above  $B_{cr}=70$  mT; for magnetite- and titanomagnetite-  
721 bearing samples (d) because of a clear outlier of the data point.

722  
723 **Figure 10.** Residual remanent magnetization (normalized to initial SIRM) under 1.24 GPa  
724 versus  $M_{rs}/M_s$  ratio for magnetite- and titanomagnetite-bearing samples with different ulvospinel  
725 content.  $M_{rs}$  and  $M_s$  are saturation remanent and induced magnetizations.

726  
727 **Figure 11.** Synthetic graph of residual remanent magnetizations (normalized to initial SIRM)  
728 under 1.24 GPa versus coercivity of remanence  $B_{cr}$  for different magnetic mineralogies.  
729 Logarithmic fits correspond to the indicated fits by solid lines from Fig. 9.

730

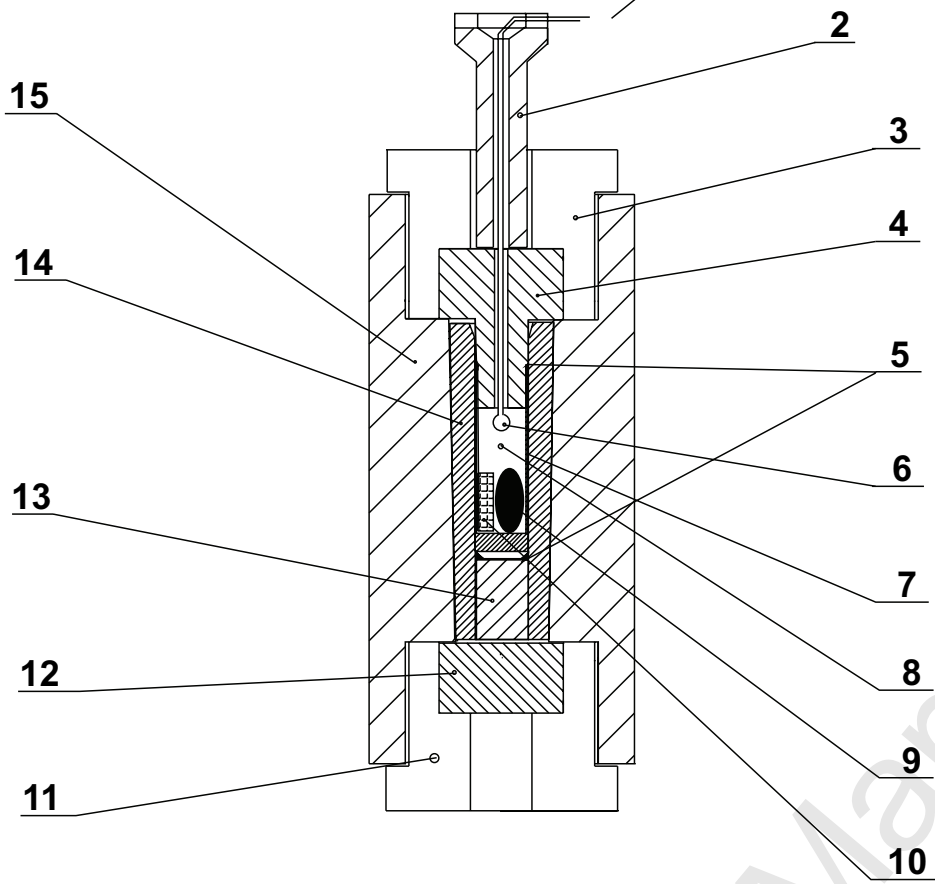

Accepted Manuscript



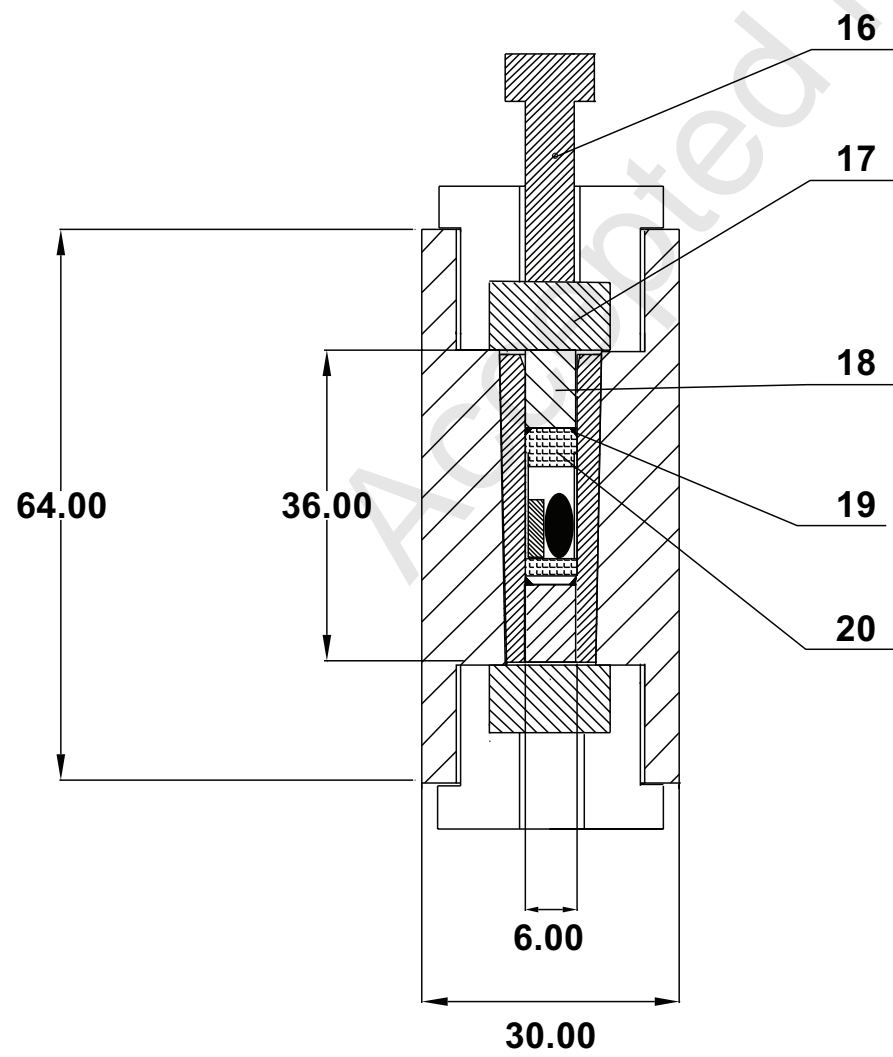

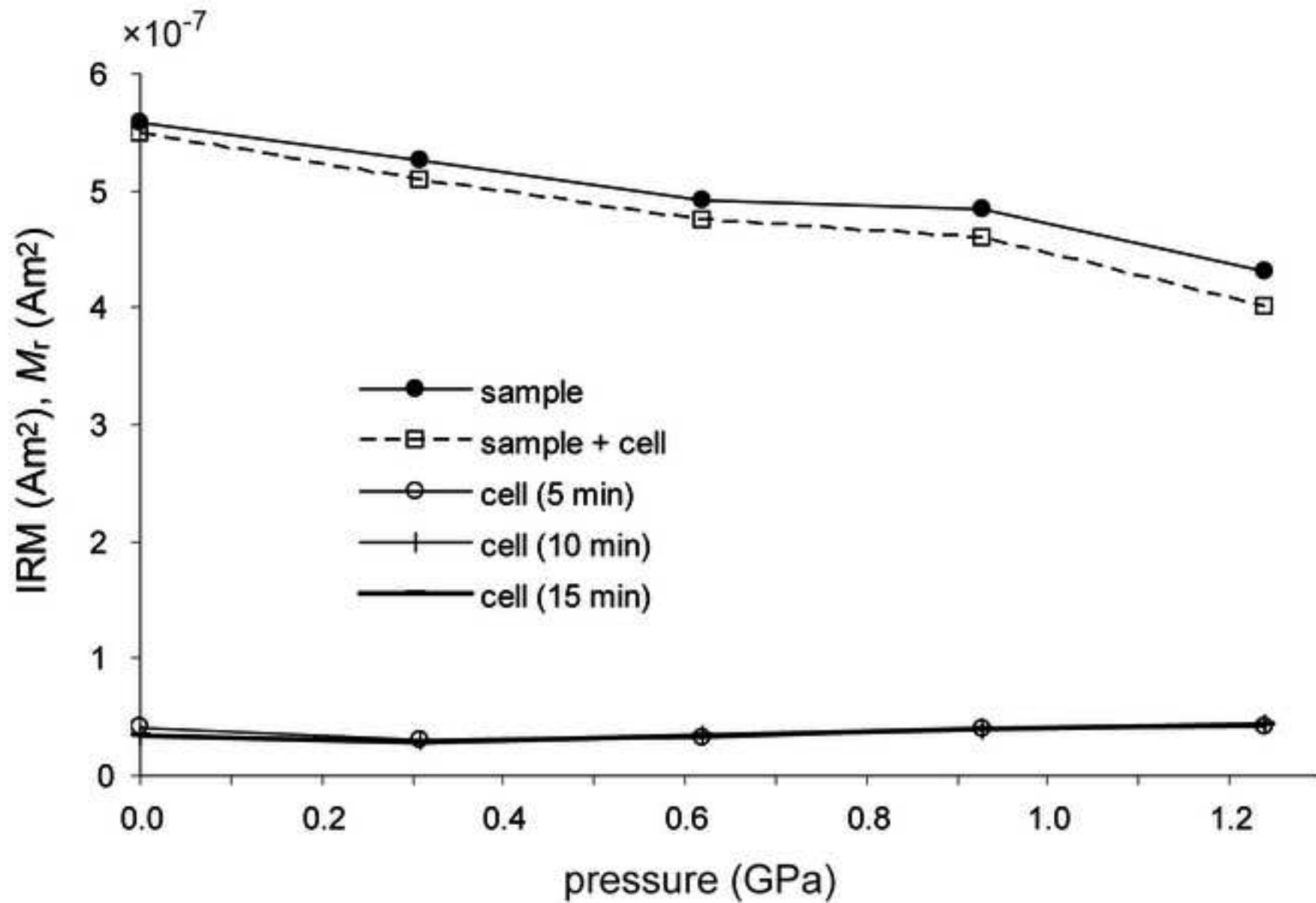

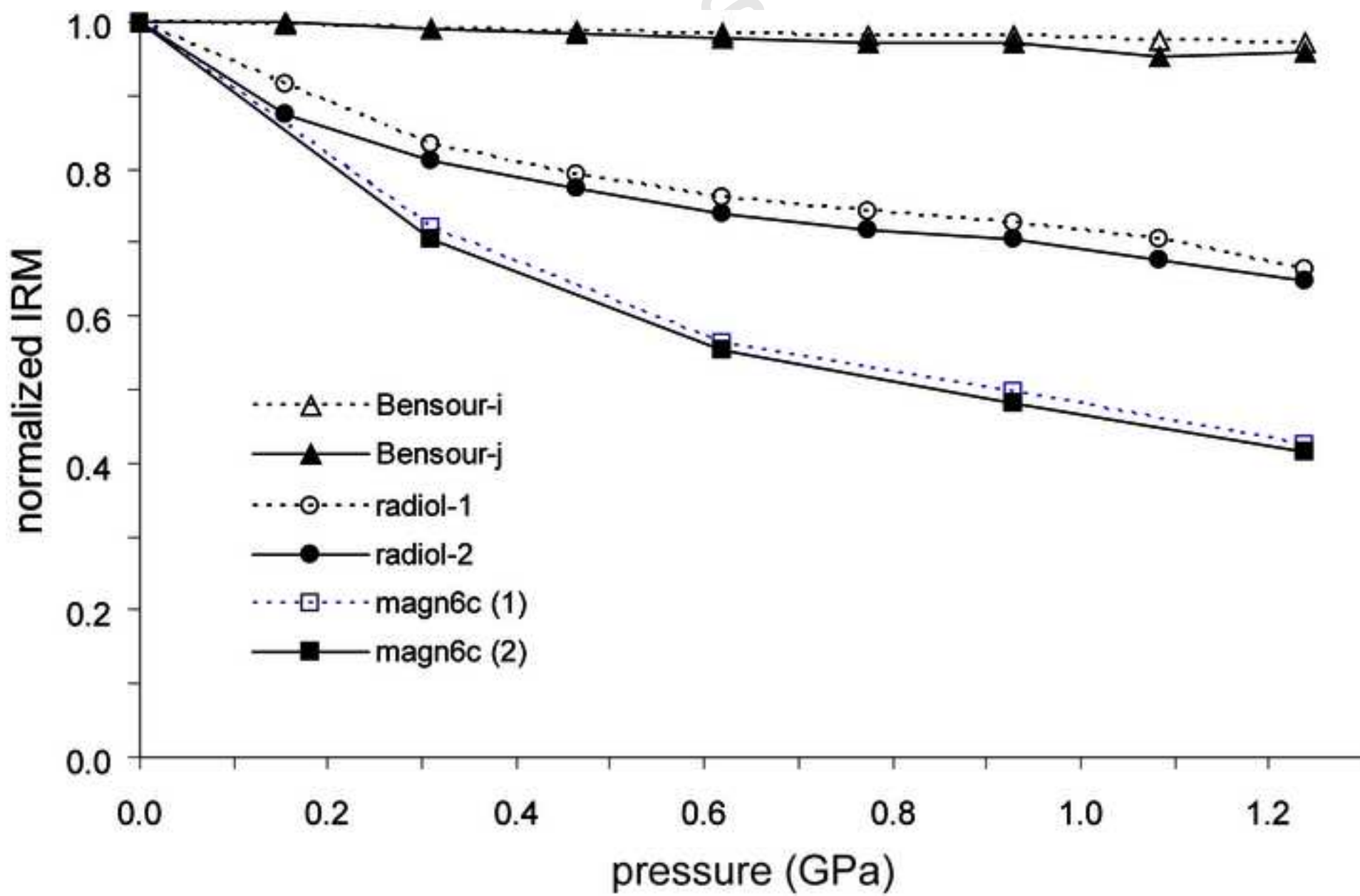

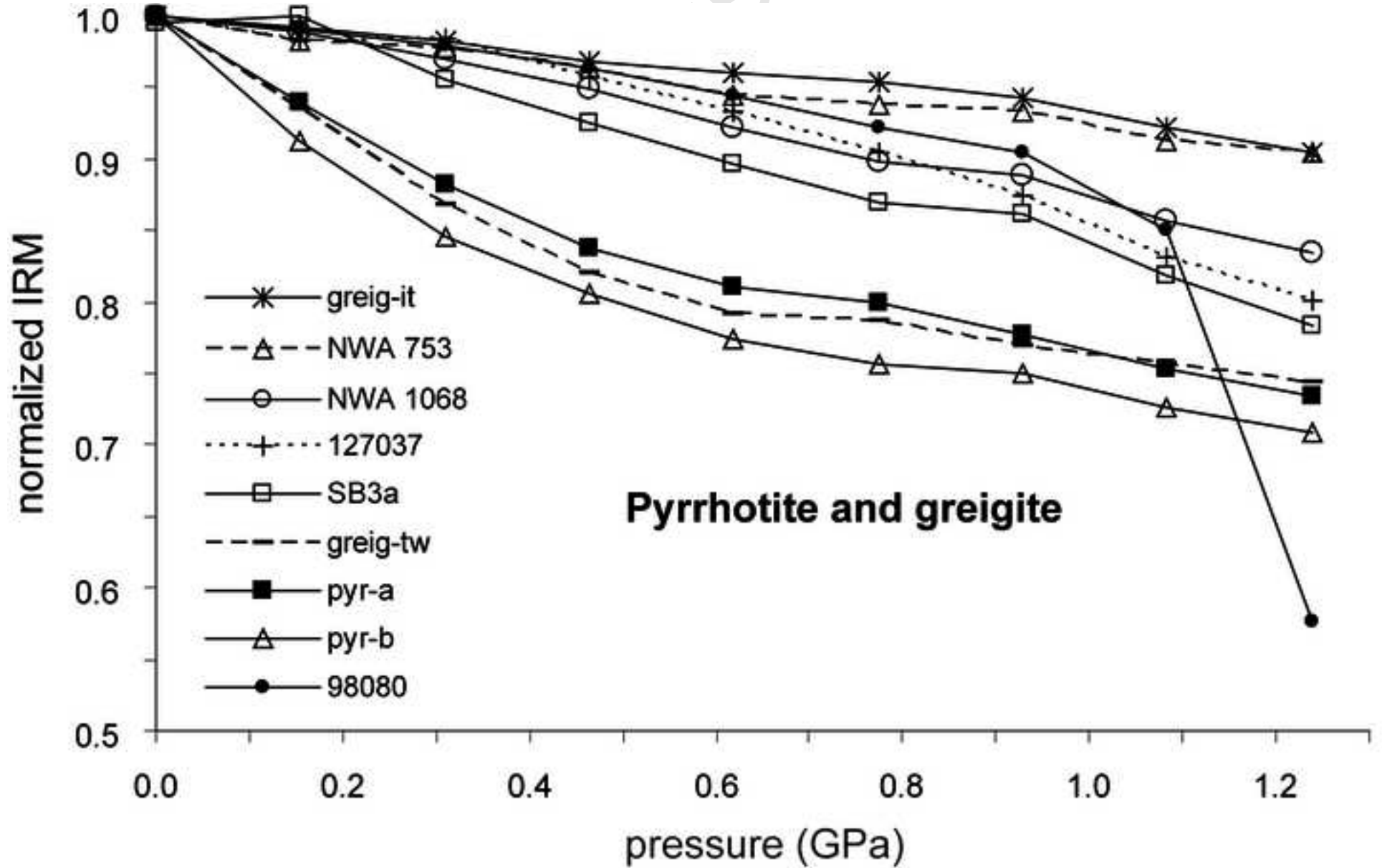

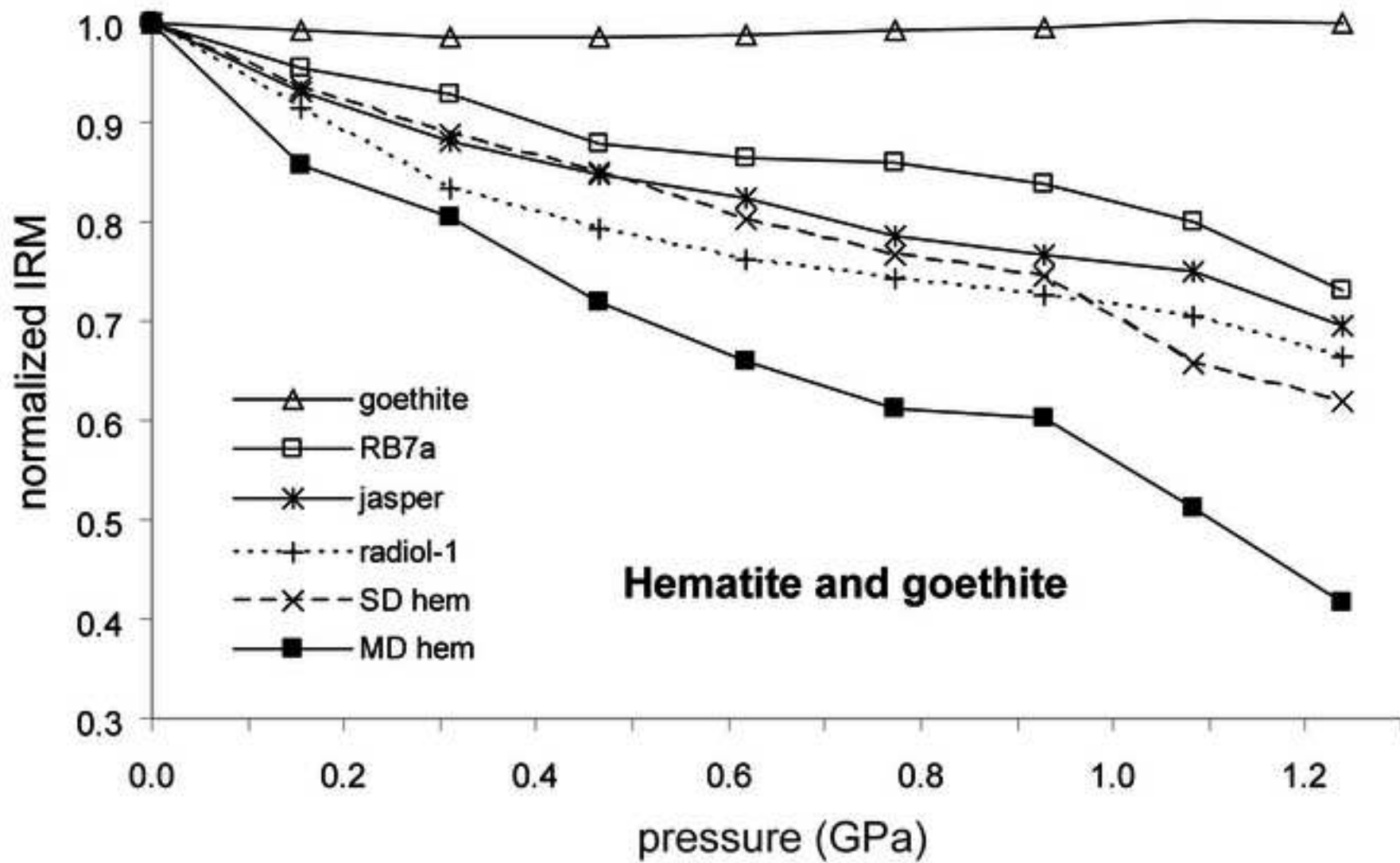

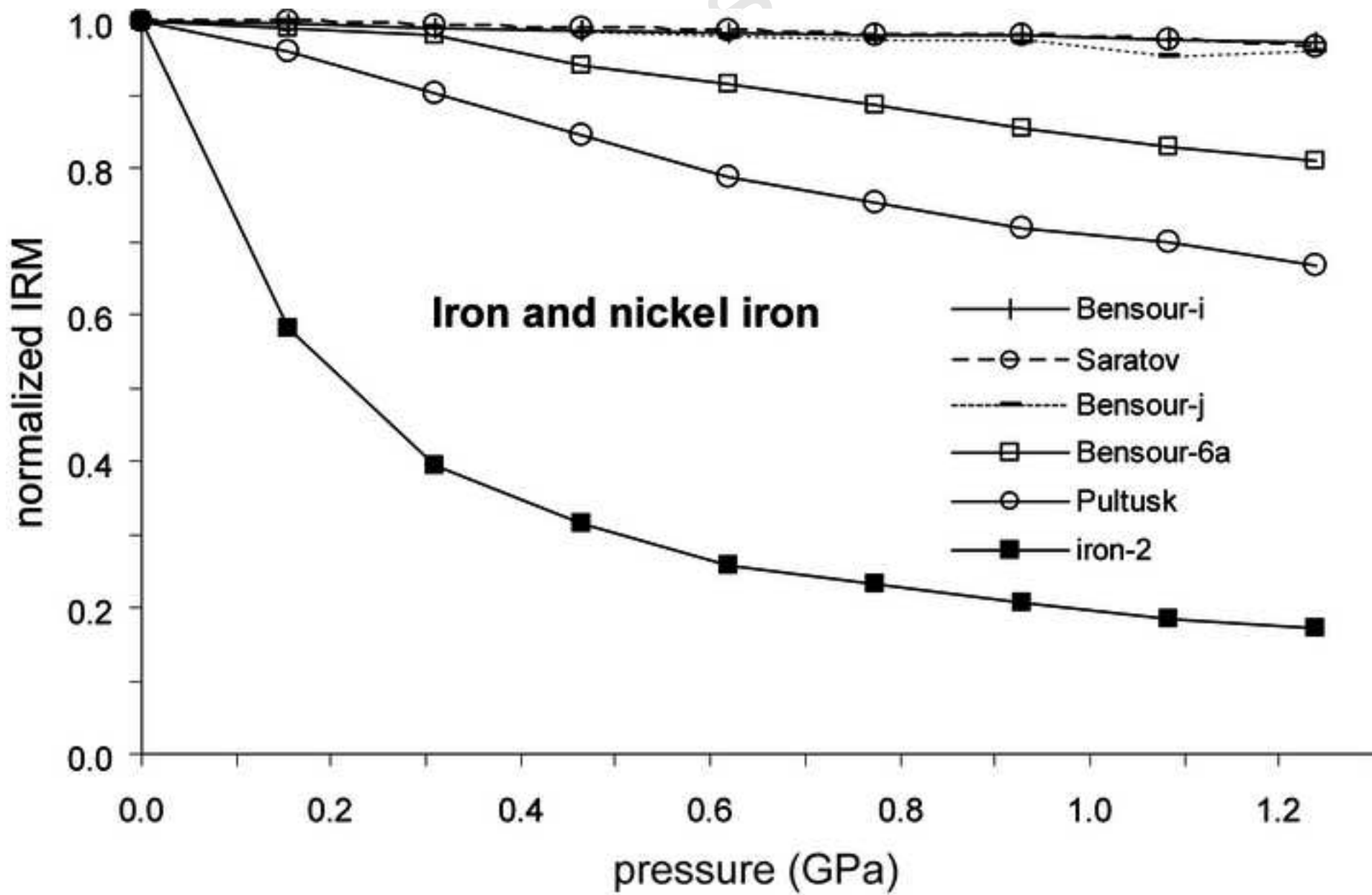

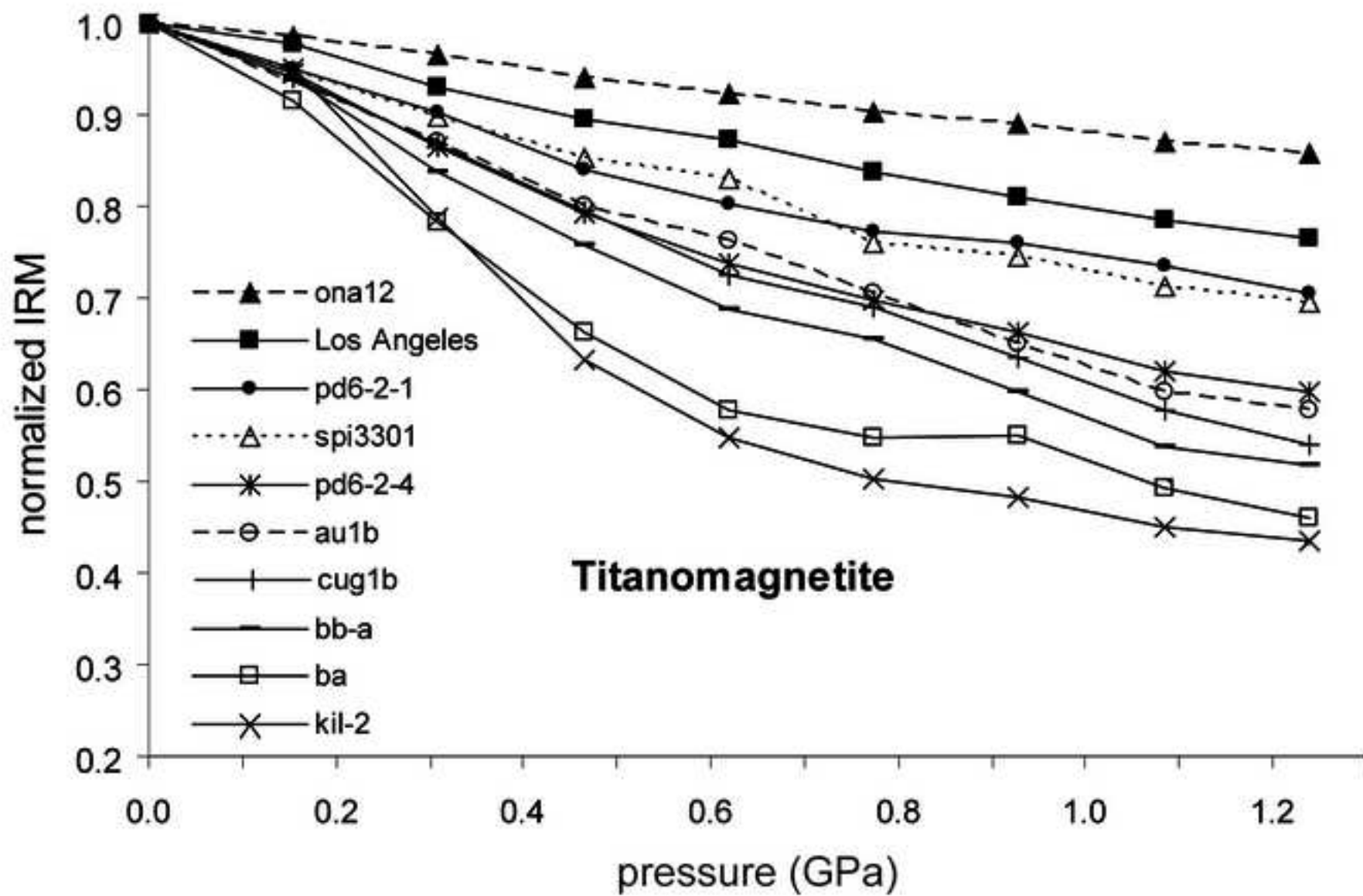

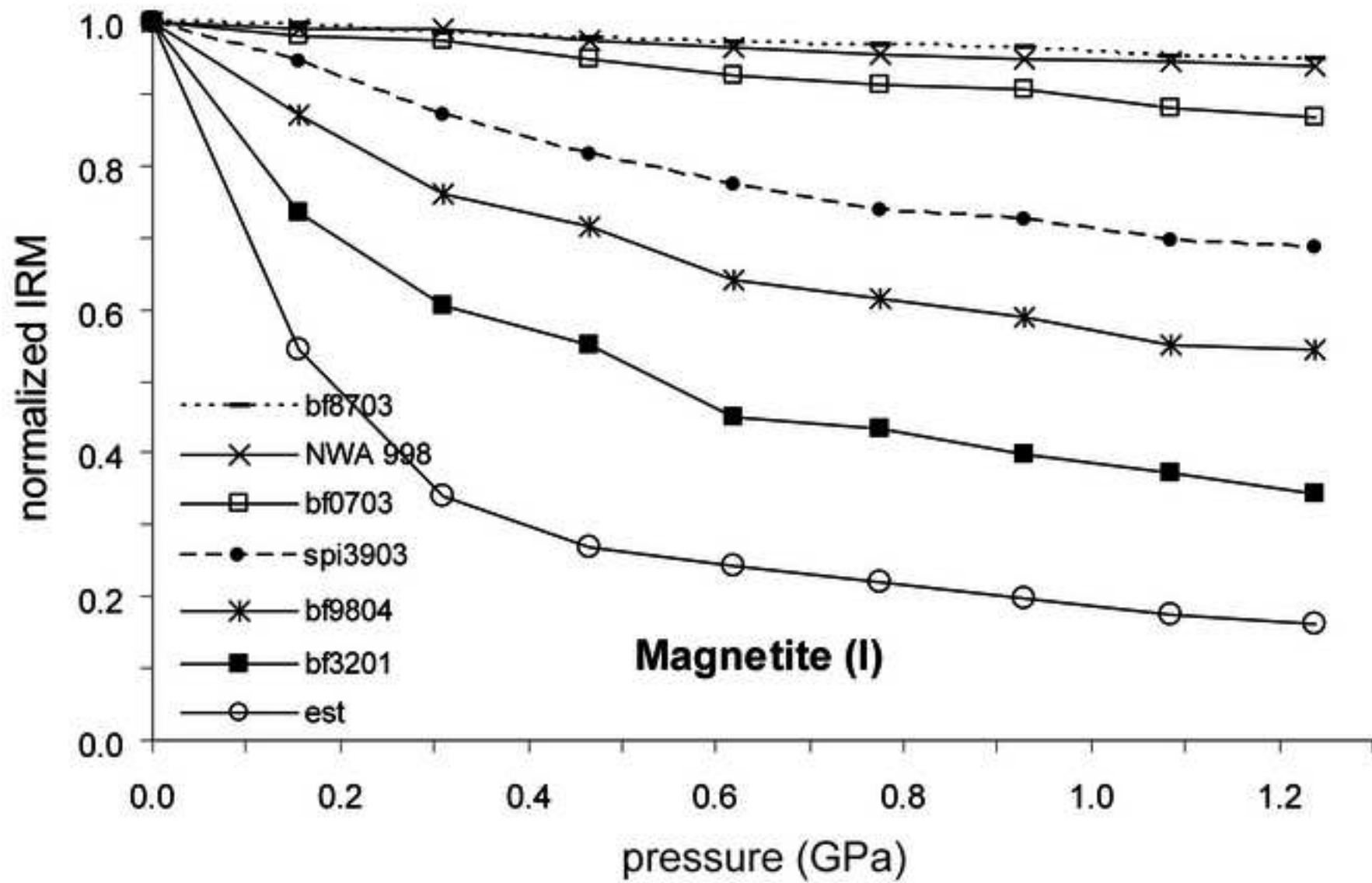



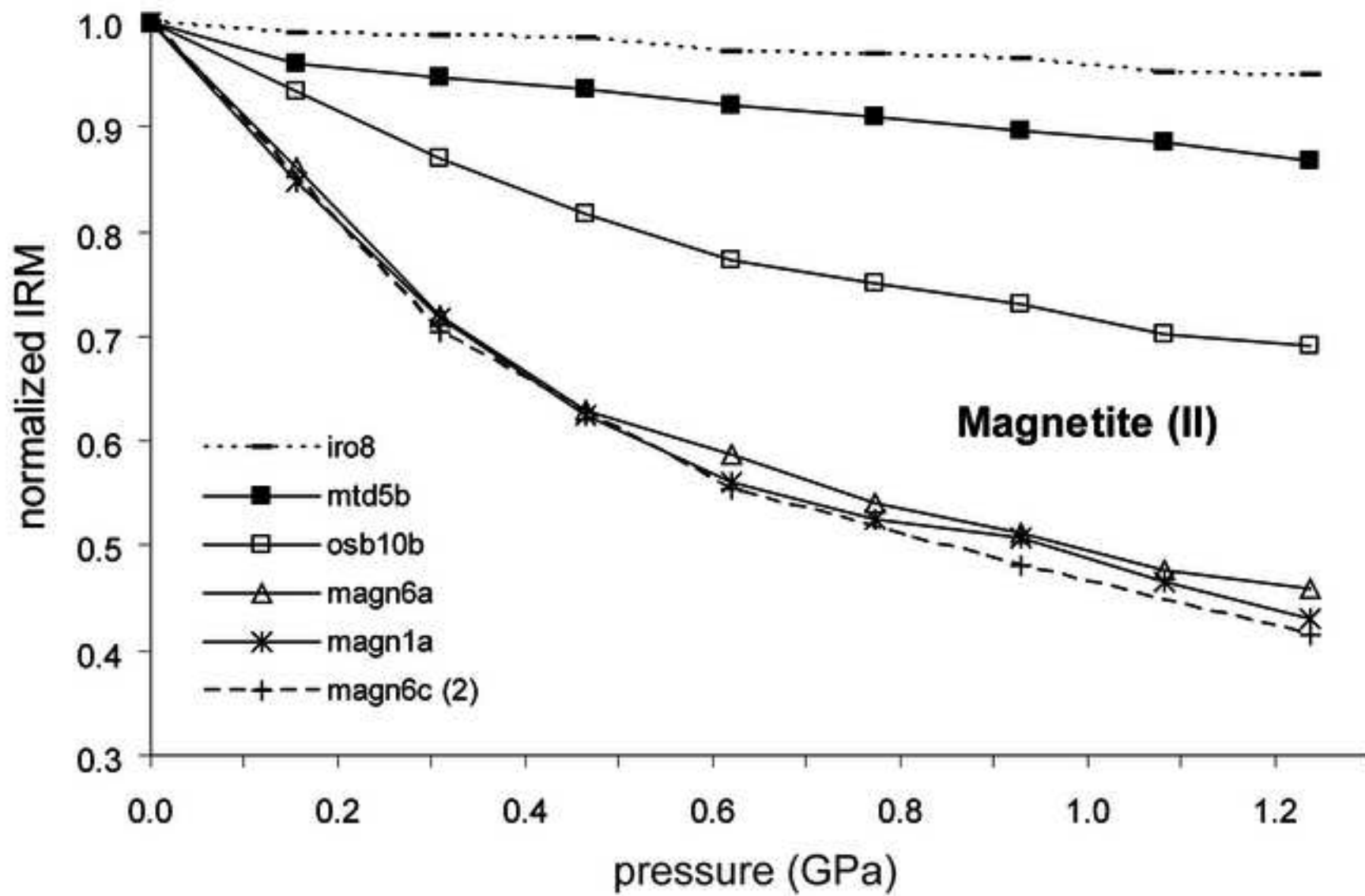

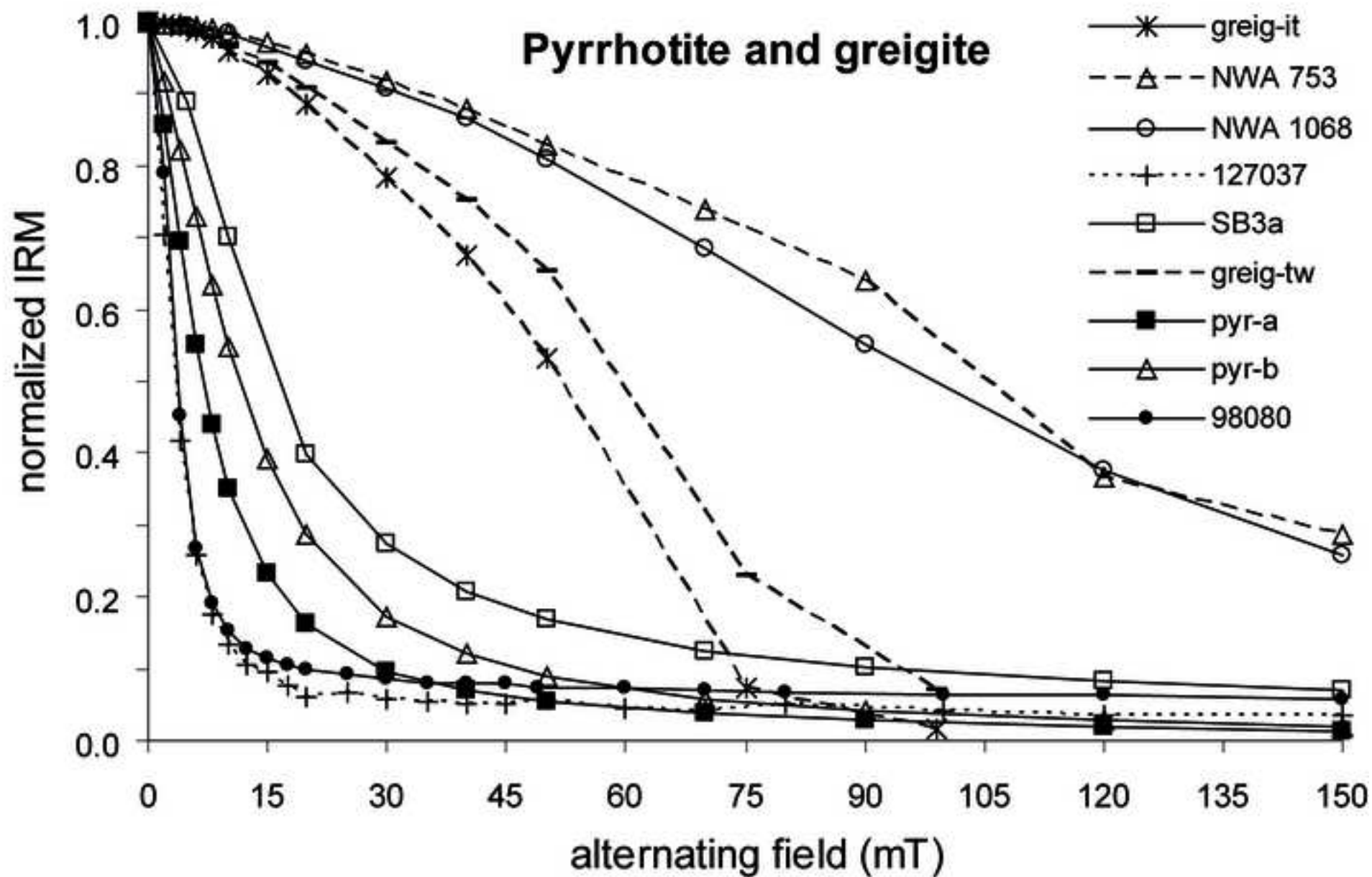

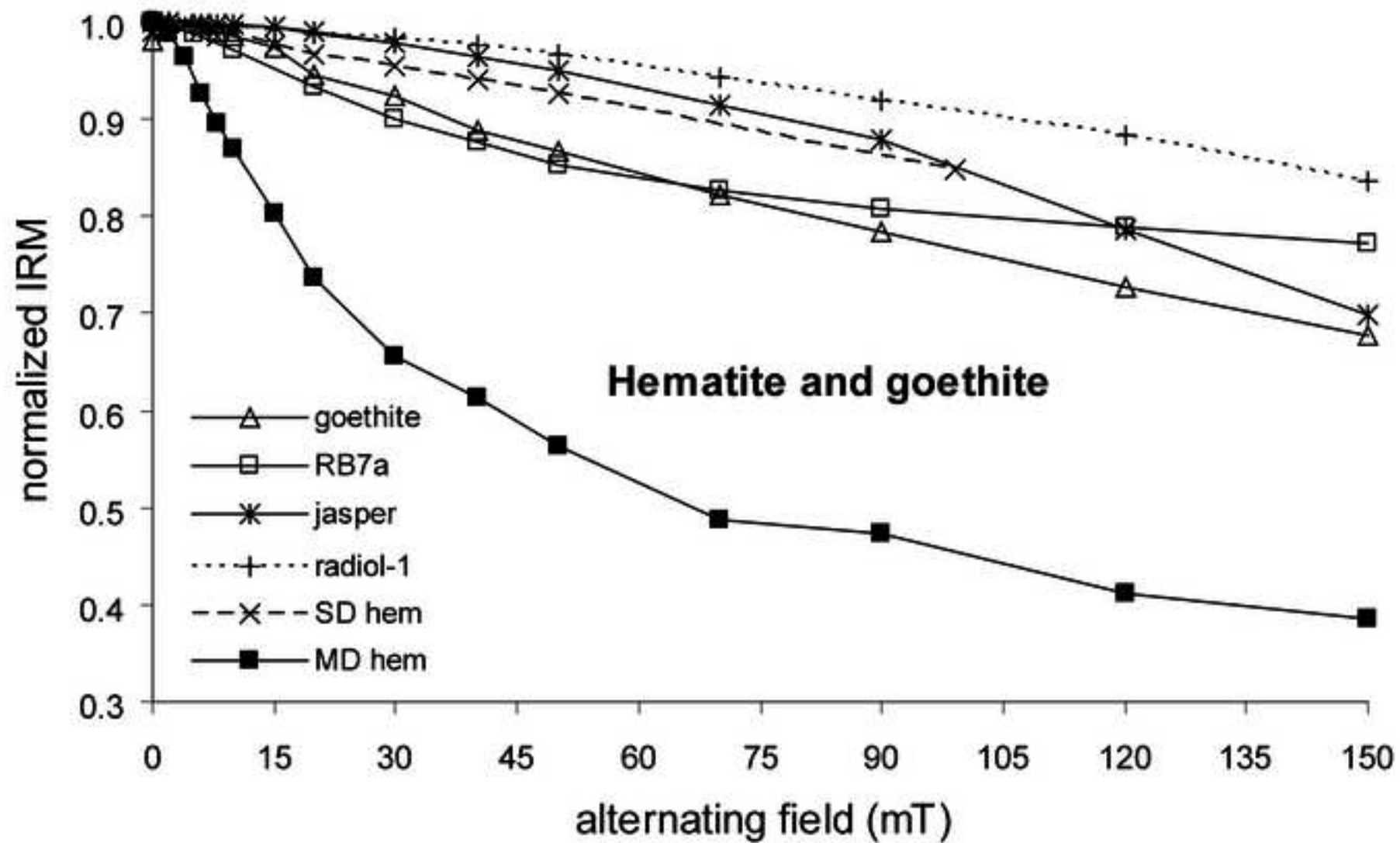

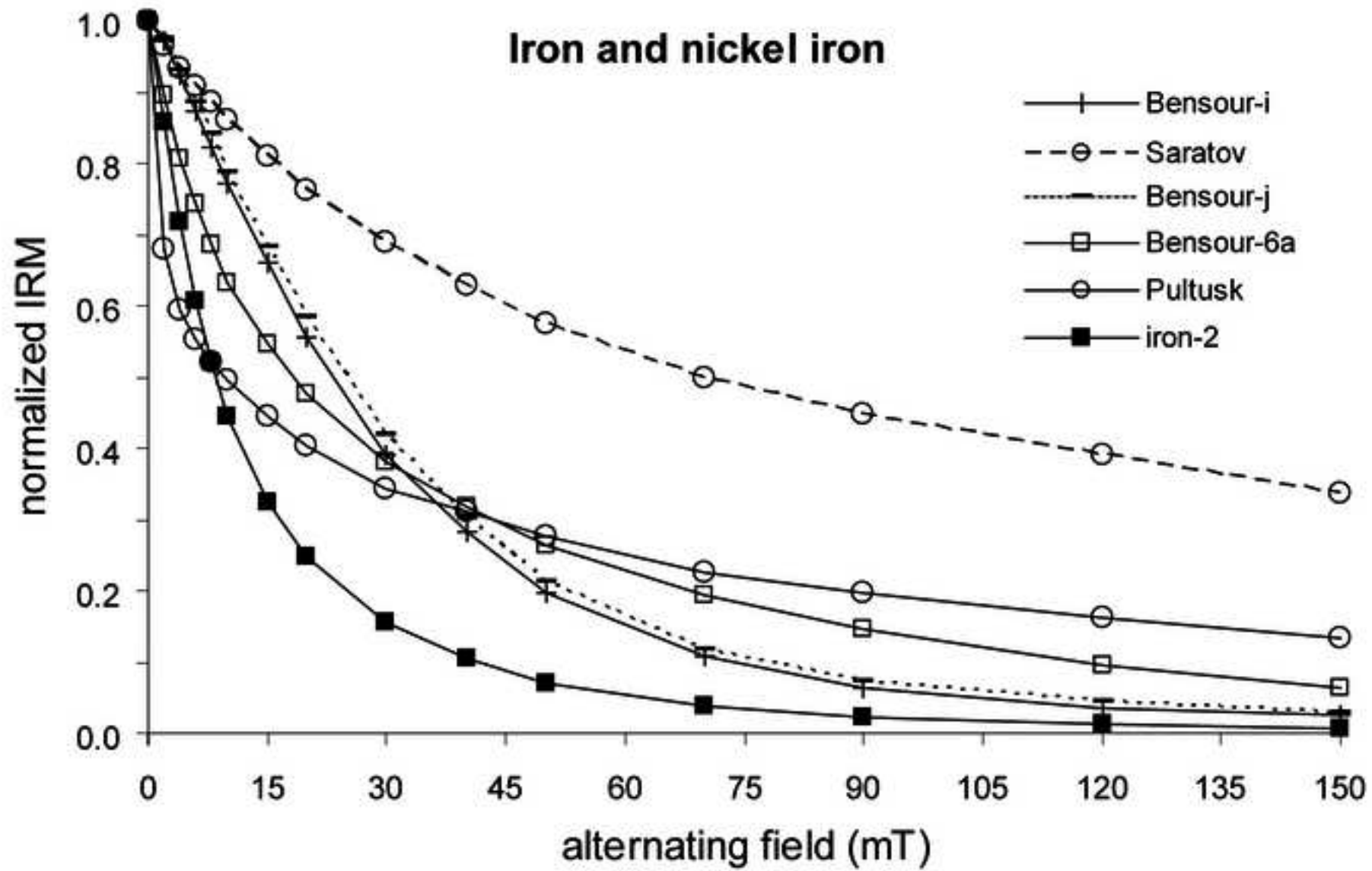

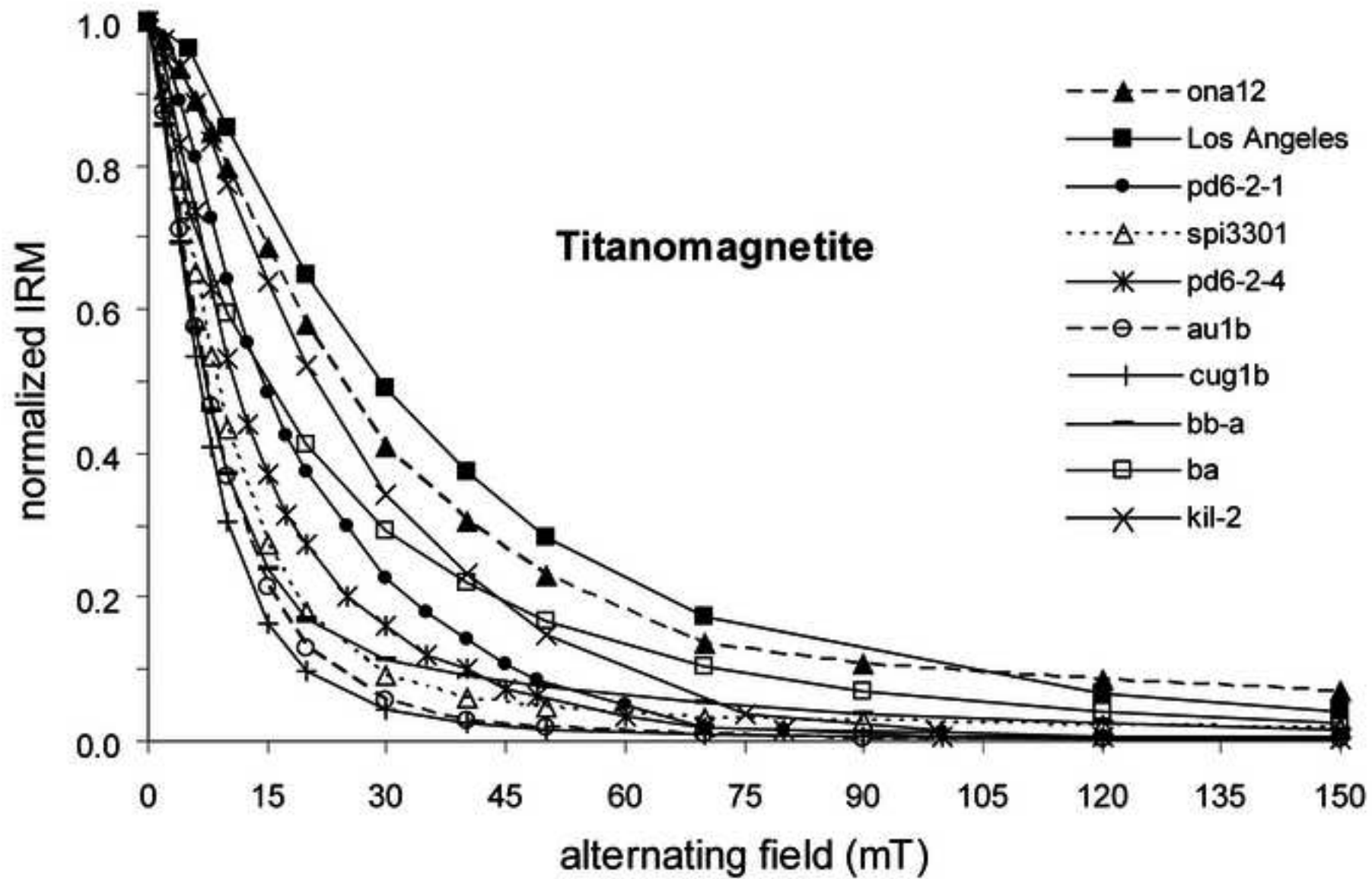

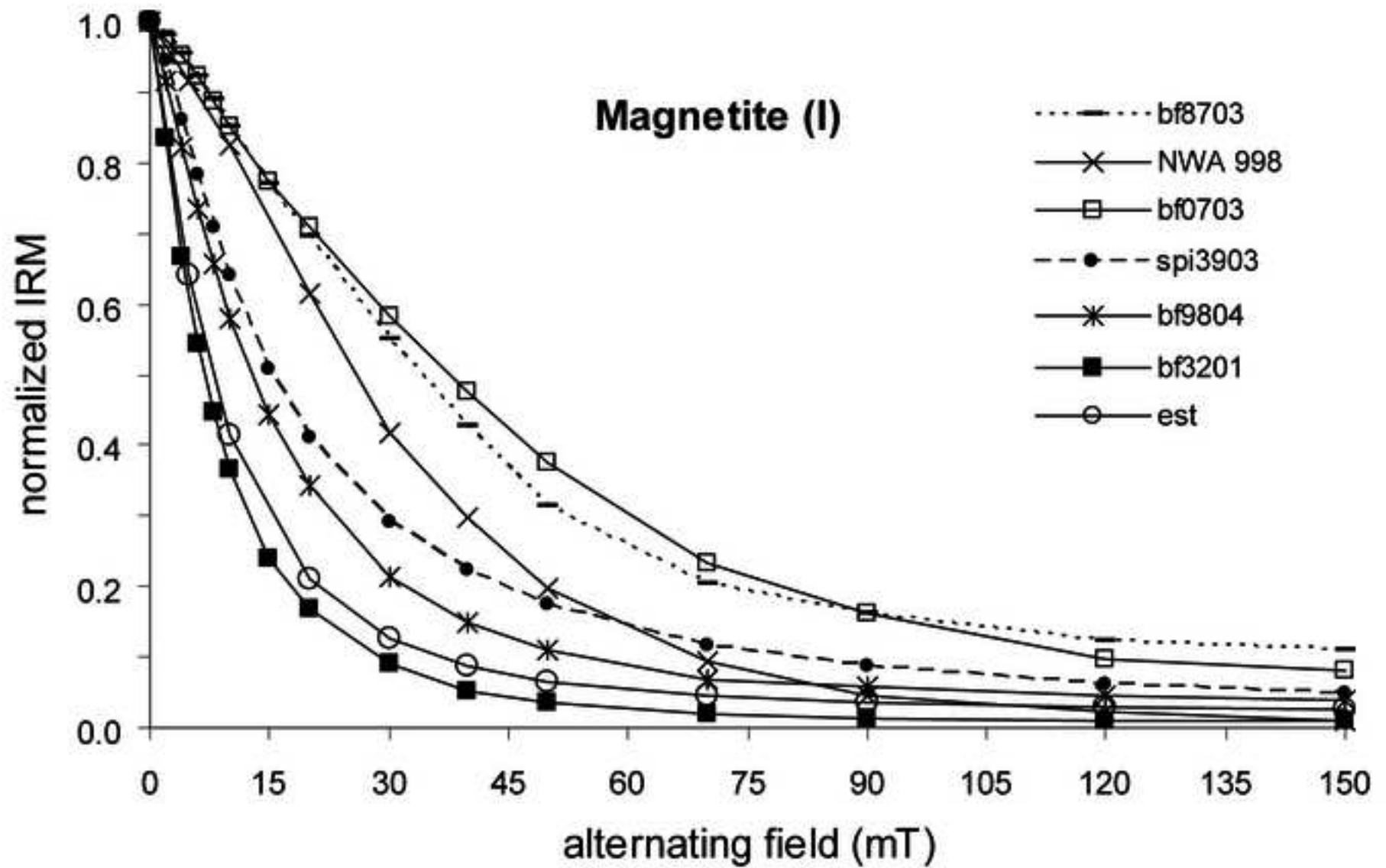

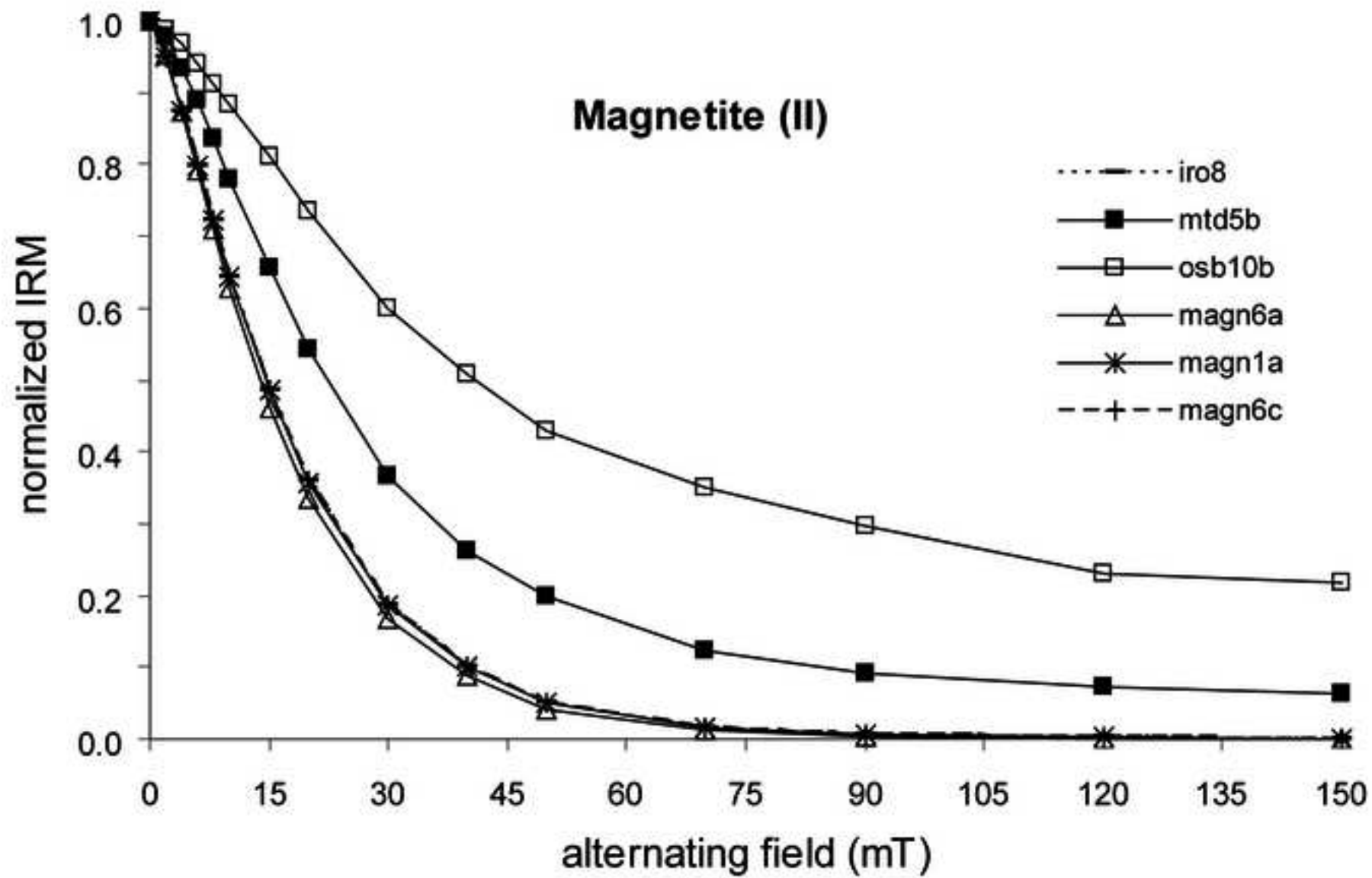

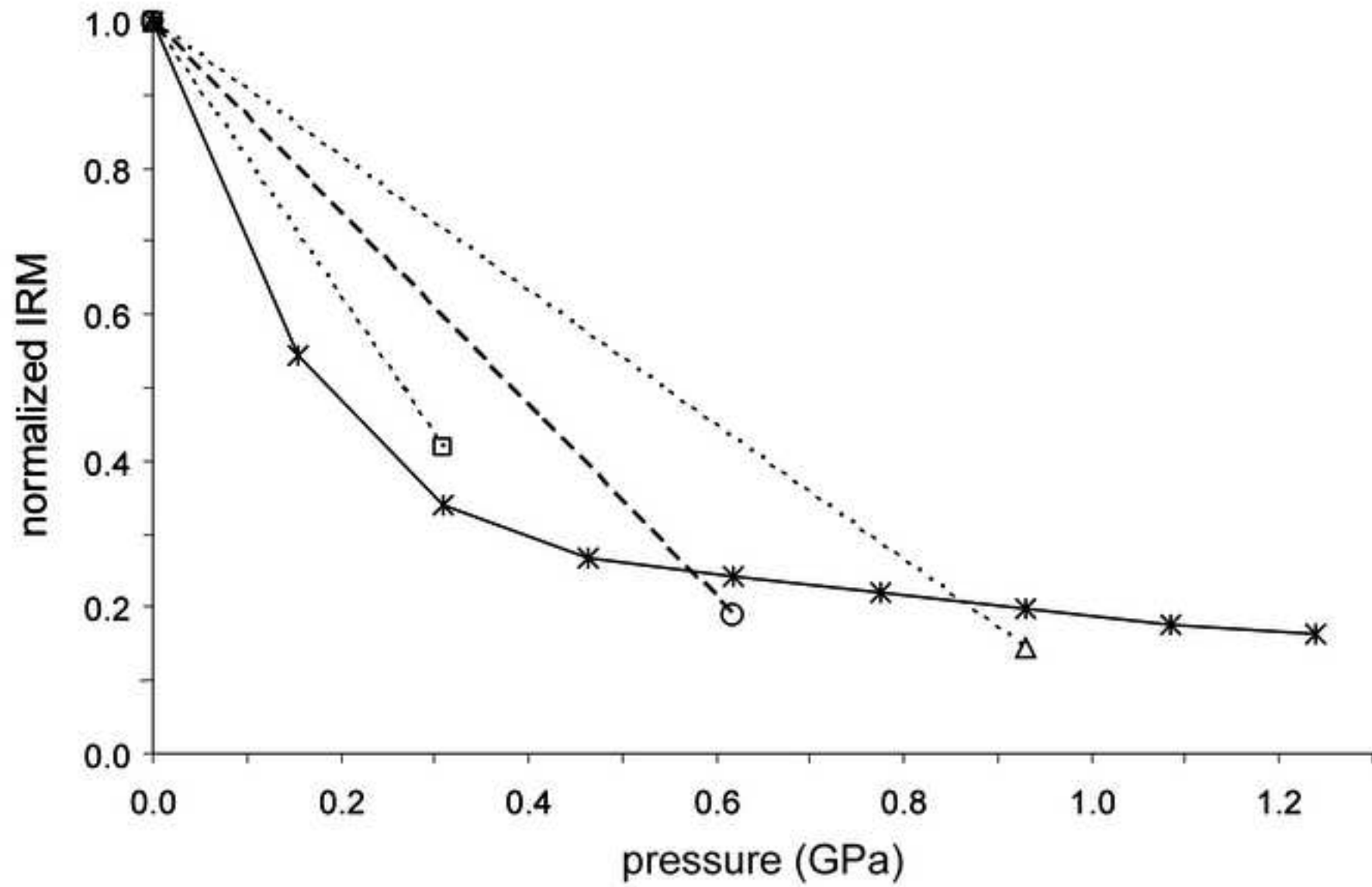



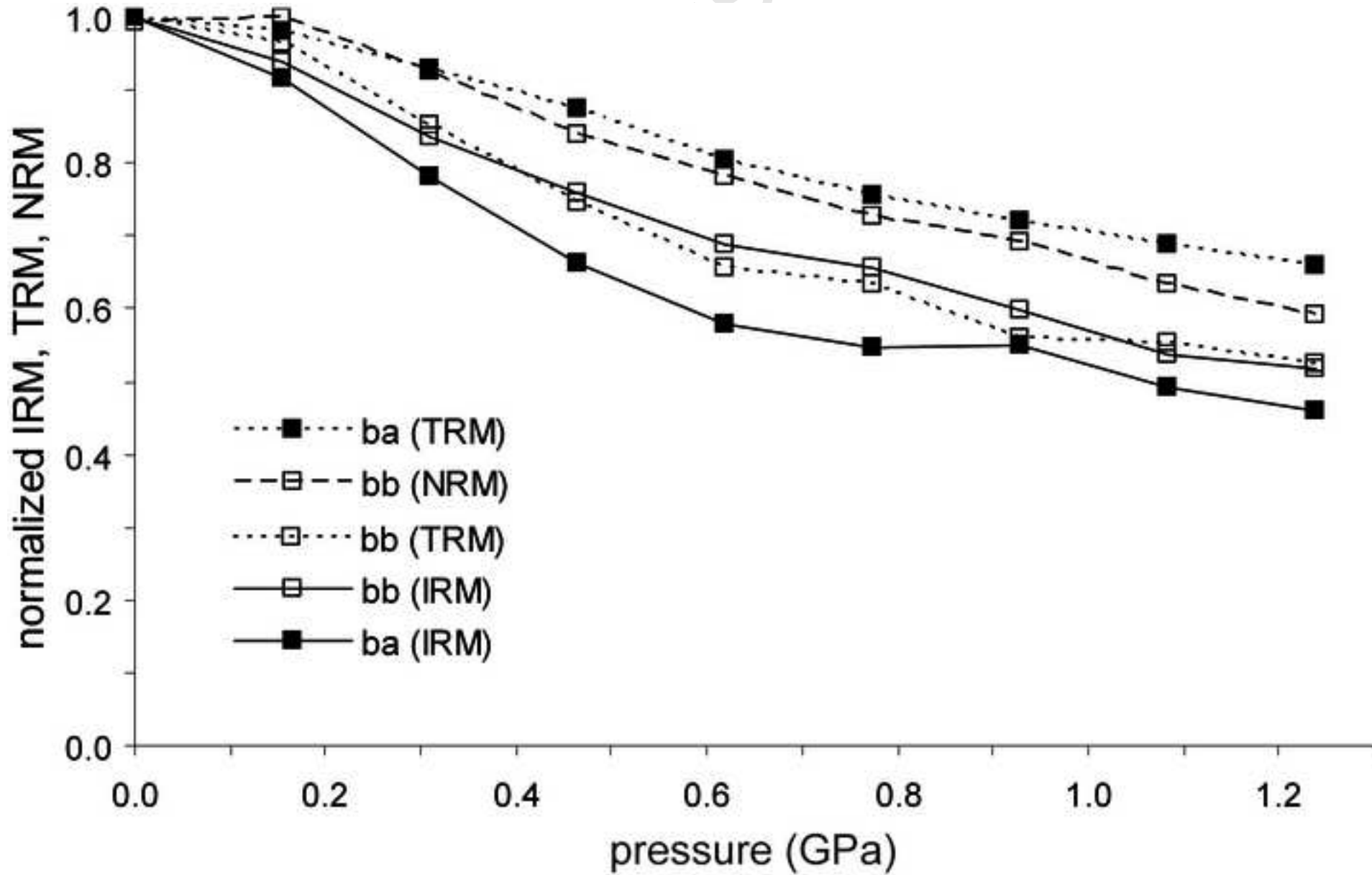

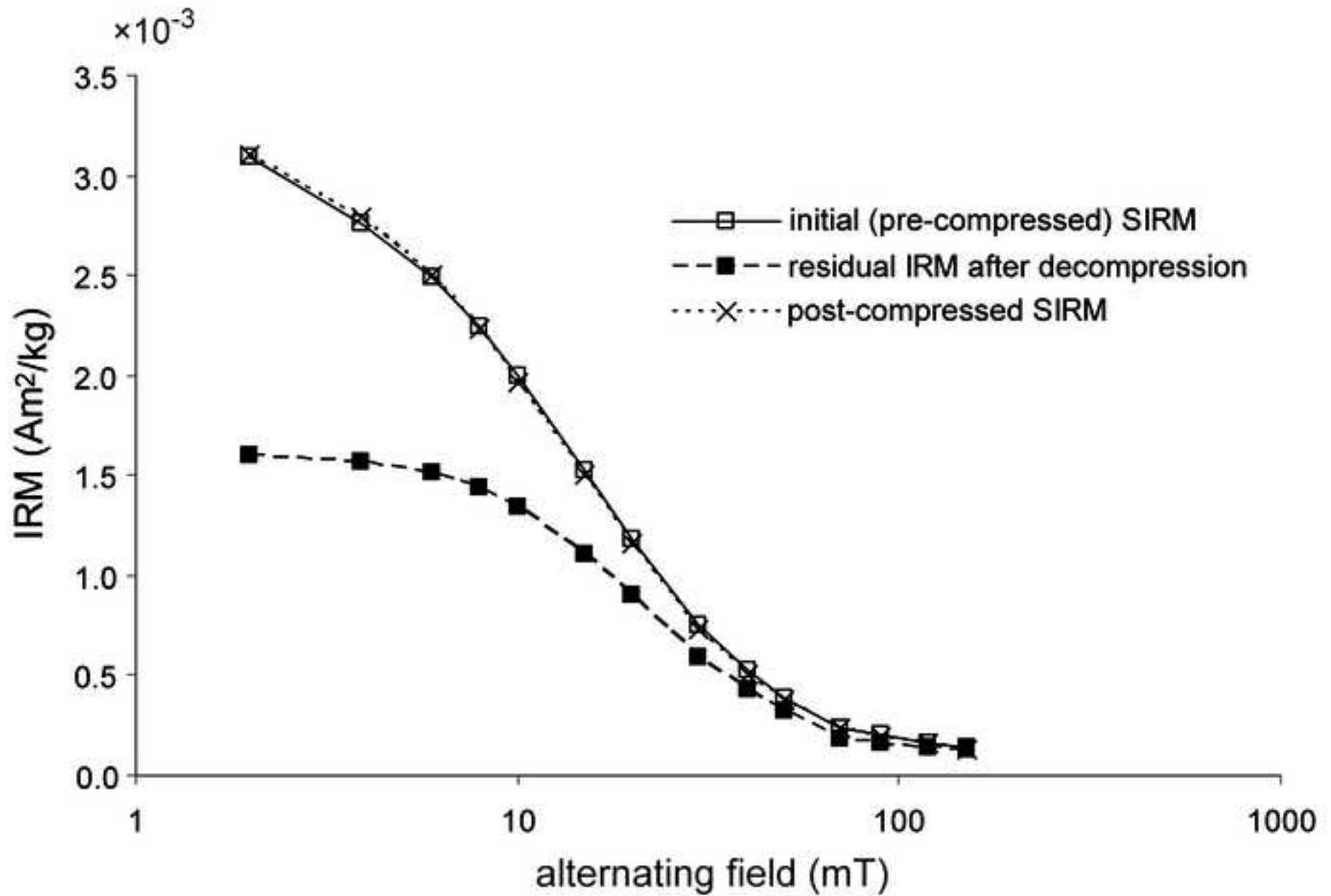

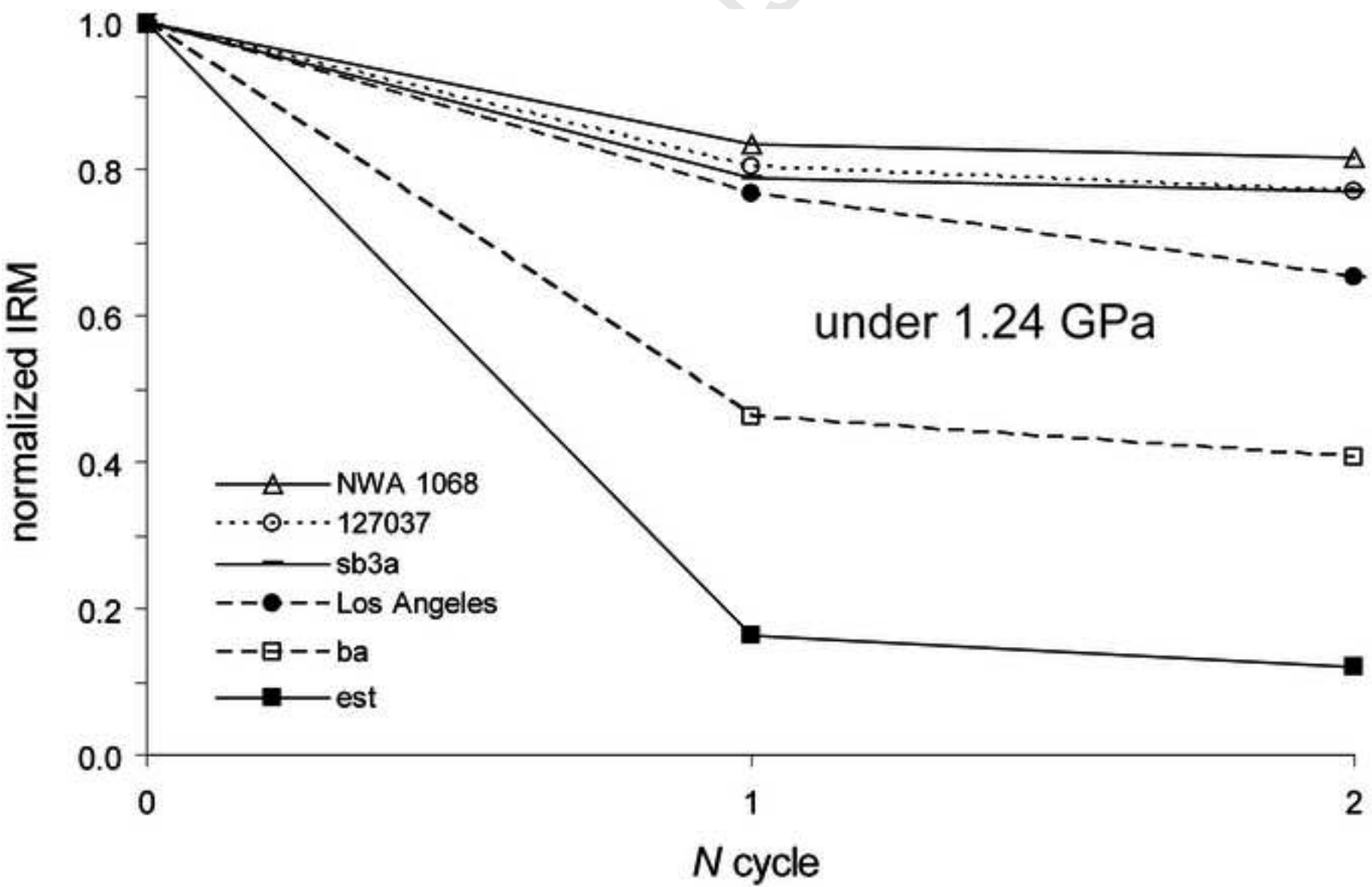

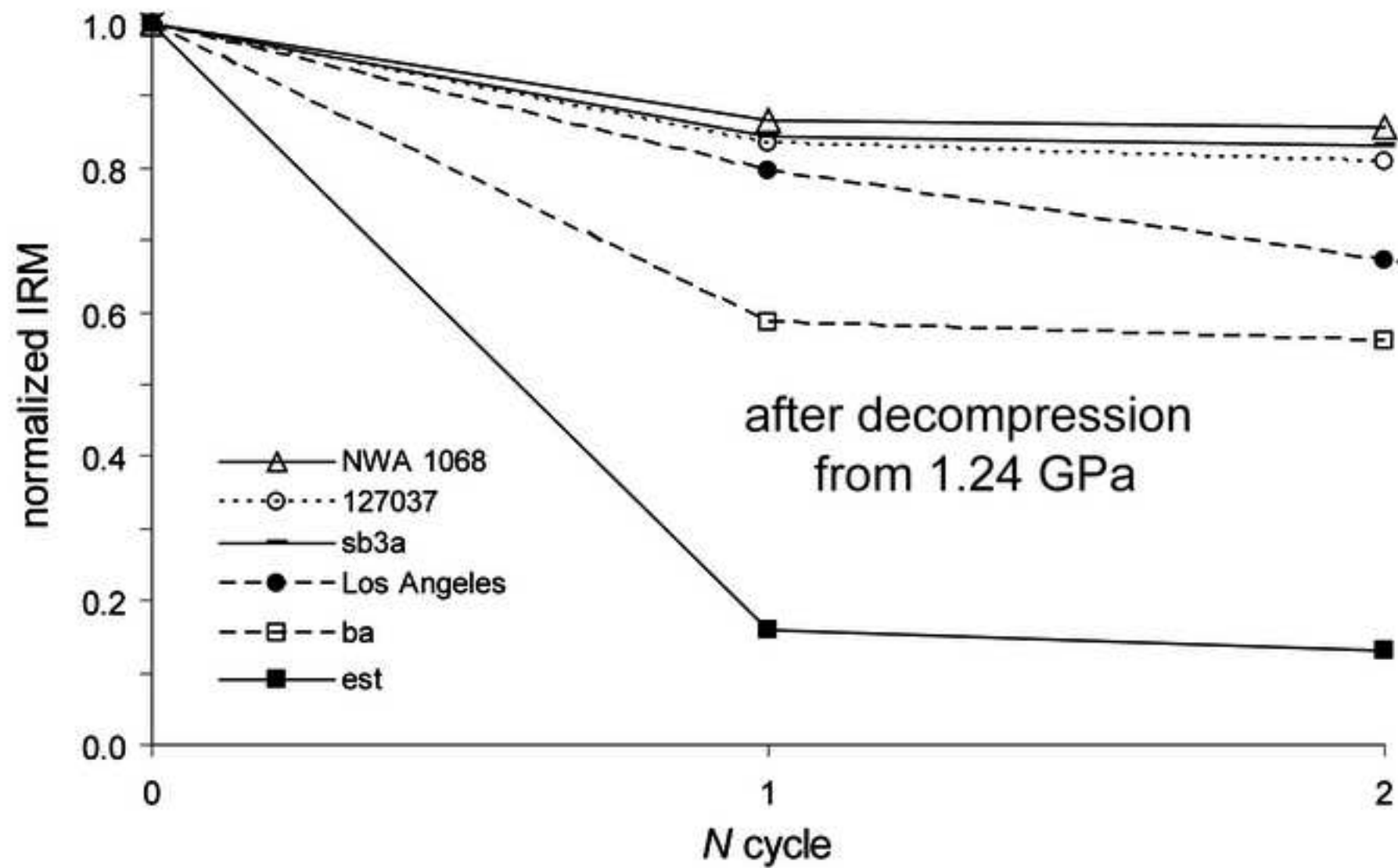

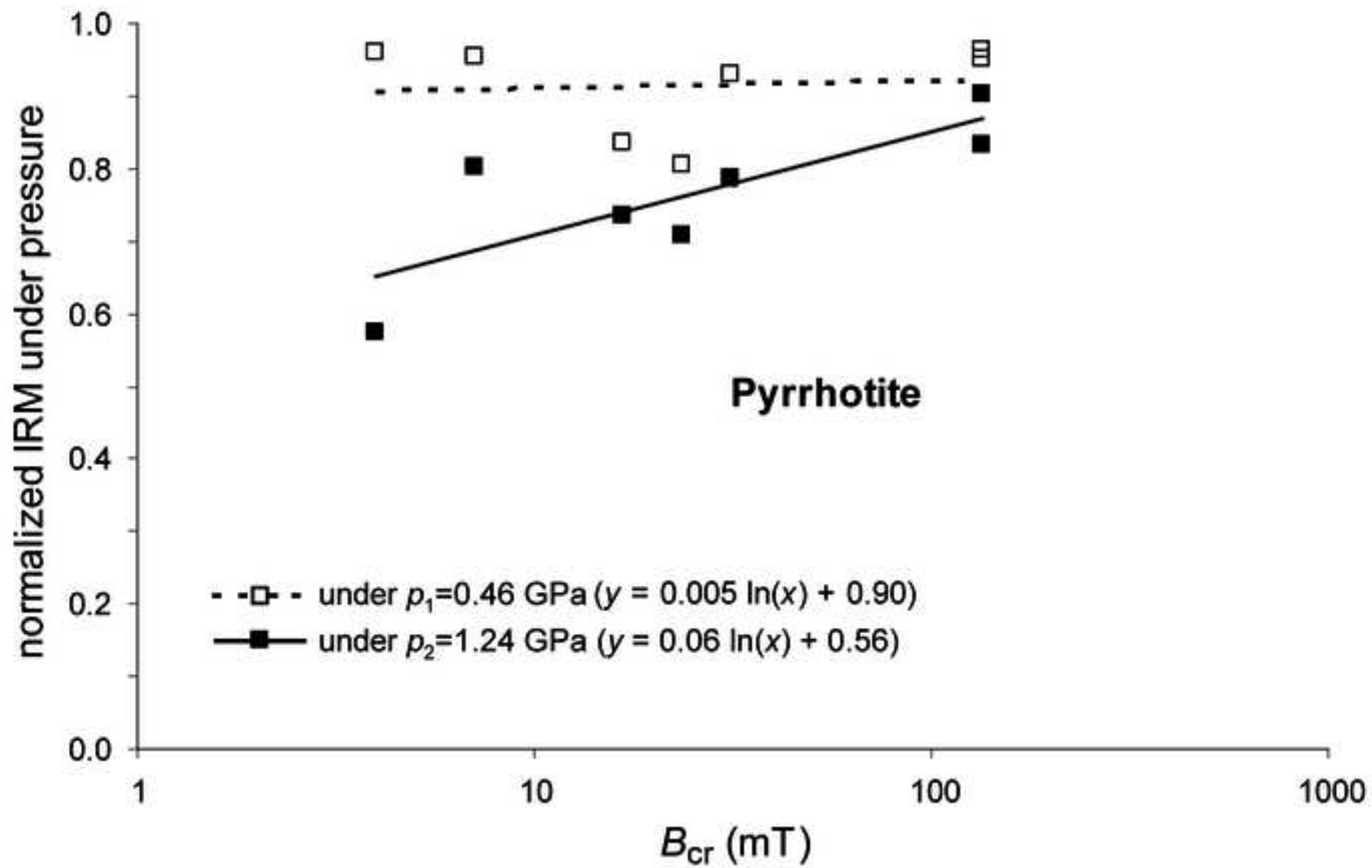

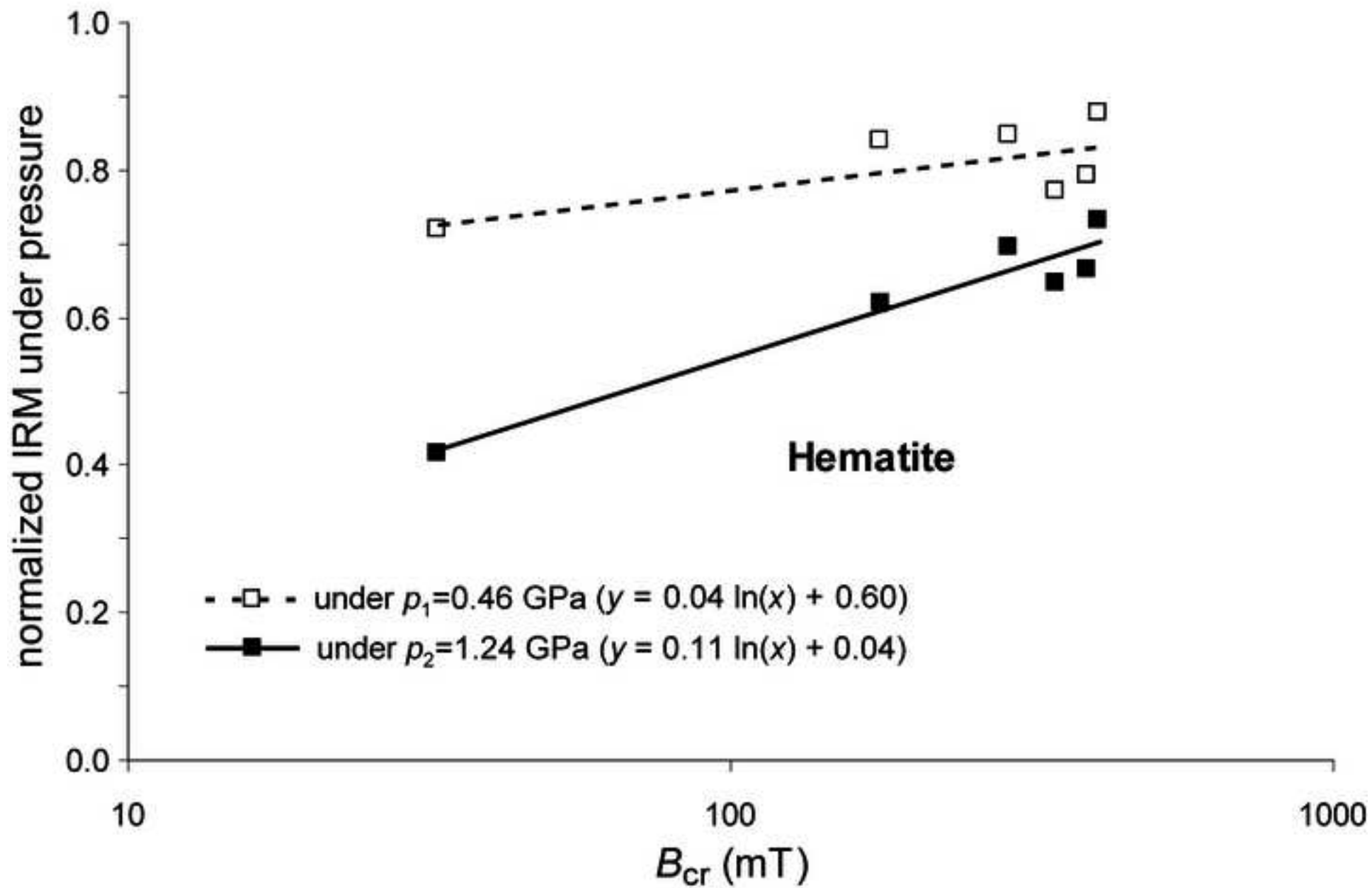

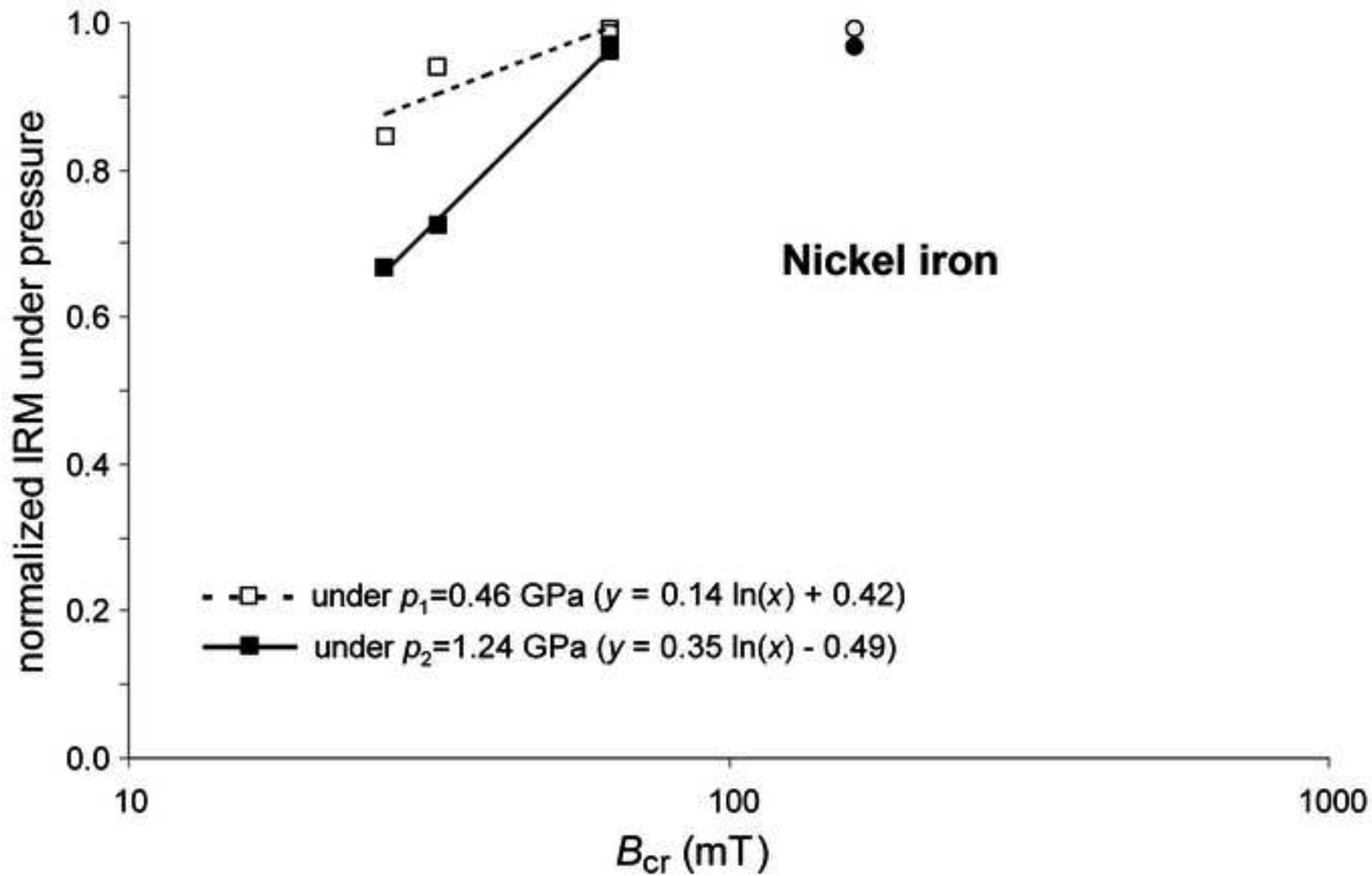

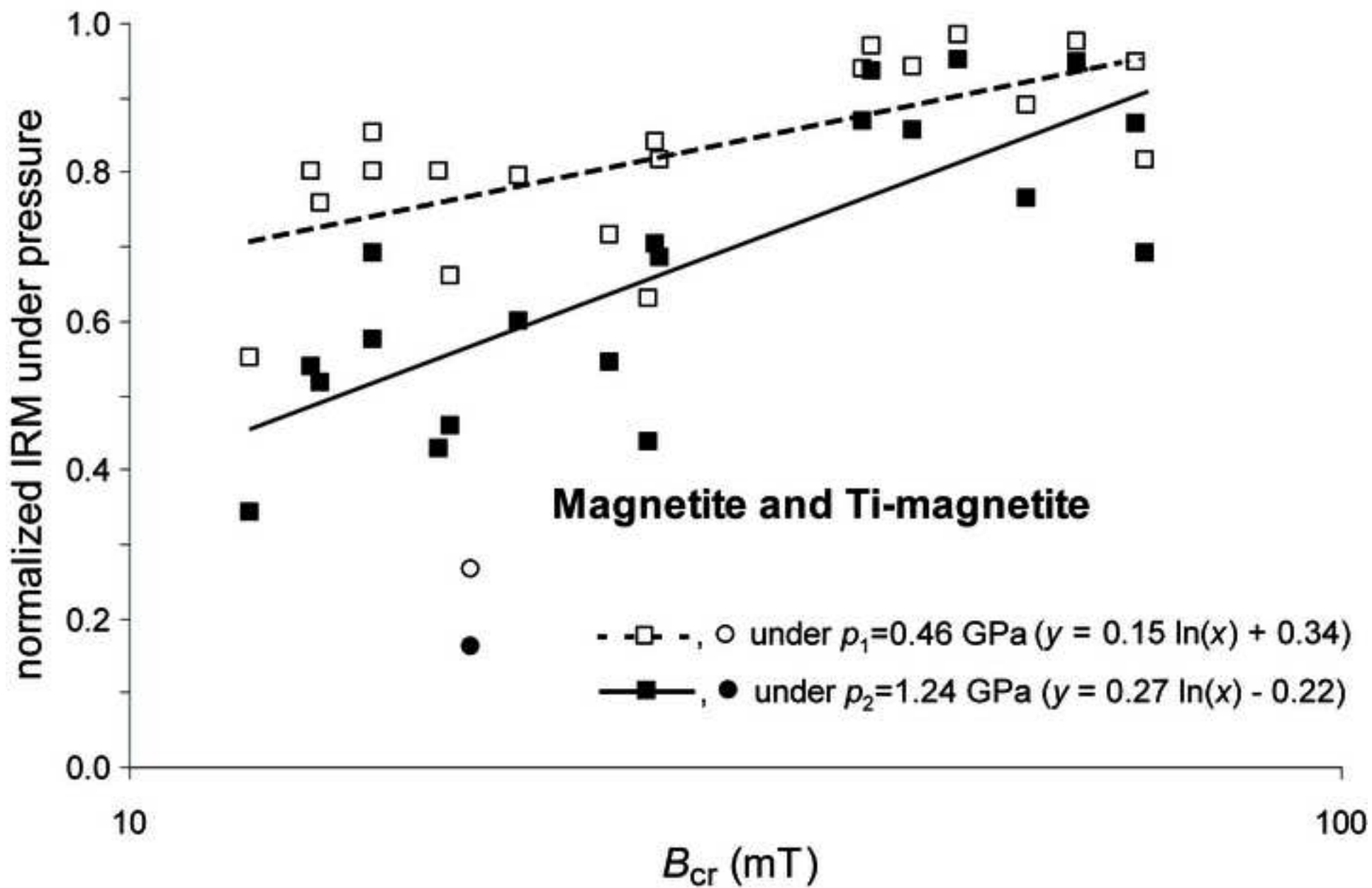



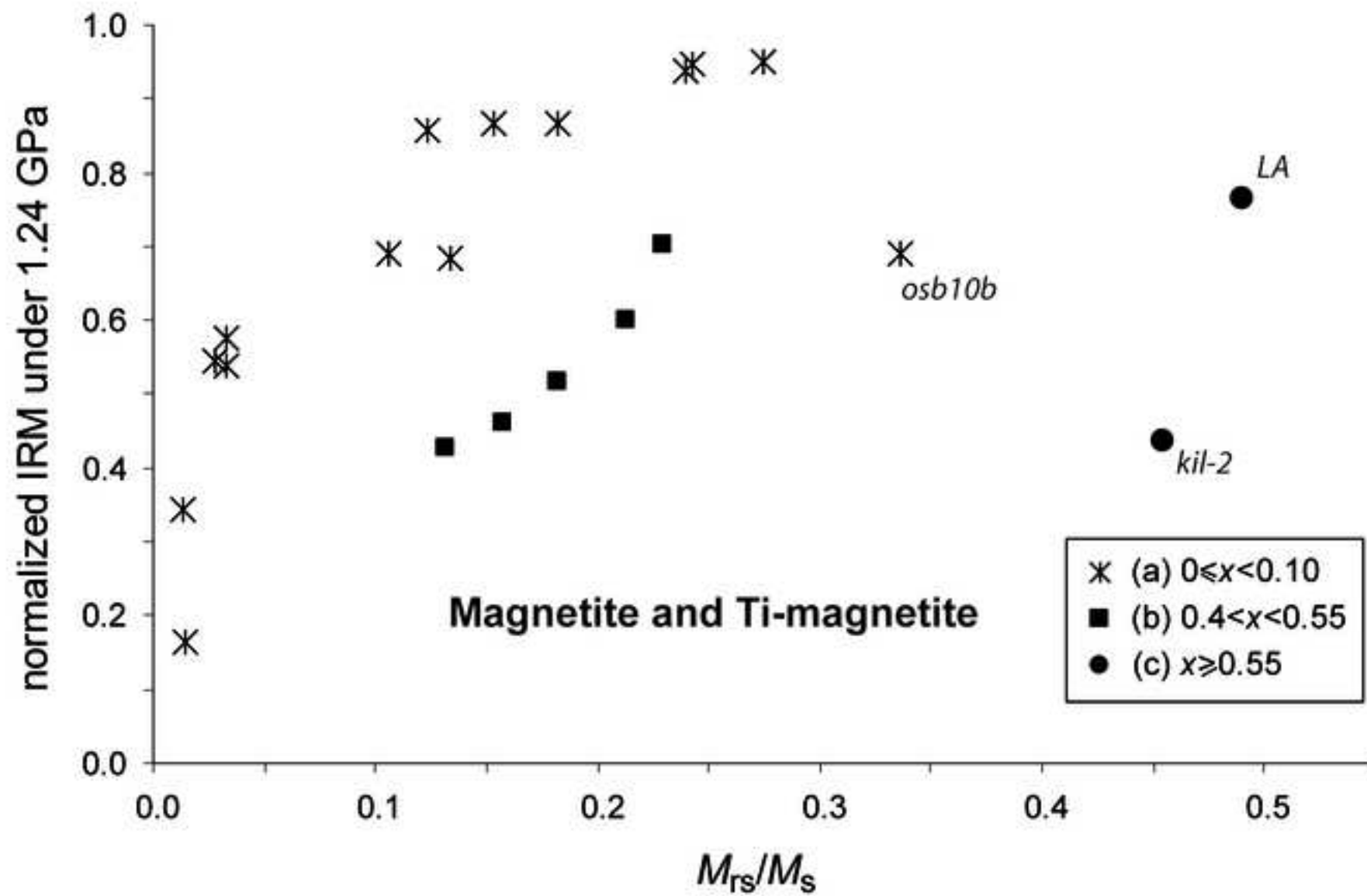

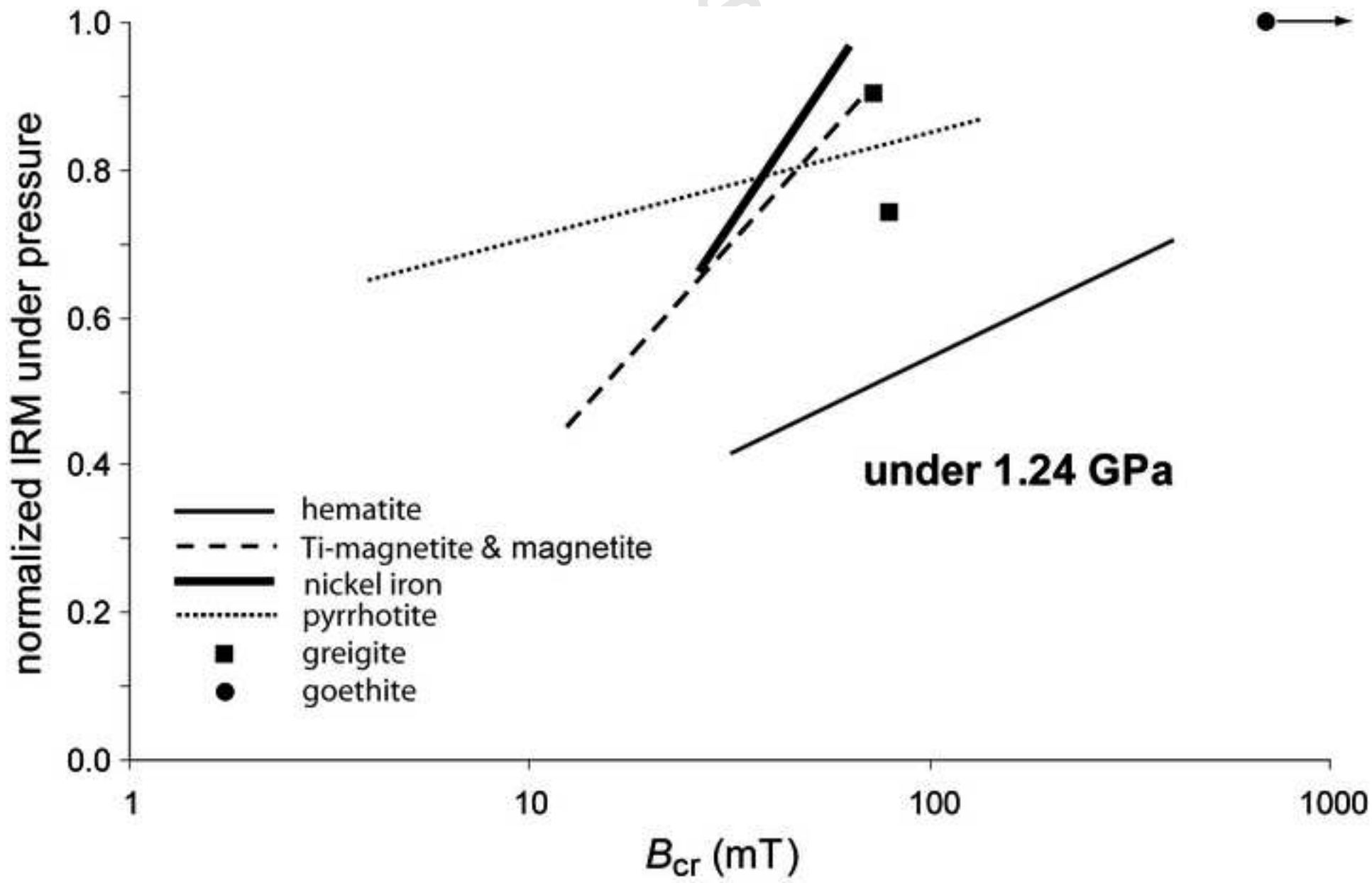

## TABLES

Table 1

Main magnetic properties of investigated samples.

Sample	Main magnetic carrier and ref.	$m$	$T_c$	$\chi_0$	MDF <sub>i</sub>	$B_{cr}$	$B_{cr}/B_c$	$M_s$	$M_{rs}/M_s$
<b>METEORITES</b>									
<b>Martian meteorites</b>									
<i>Los Angeles</i>	Ti-magn <sup>(11, 13)</sup>	94.3	150	10.3	31	55	1.41	1232	0.49
<i>NWA 1068</i>	pyrrhotite <sup>(13, 11)</sup>	240.2	325	1.3	100	134	1.54	212	0.47
<i>NWA 998</i>	magnetite <sup>(13, 11)</sup>	20.4	575	4.3	25	41	1.73	713	0.24
<b>Ordinary chondrites</b>									
<i>Bensour-6a</i>	taenite <sup>(0, 1)</sup>	162.0	450	154.0	18	33	35.8	3187	0.003
<i>Bensour-i</i>	tetrataenite <sup>(0, 1)</sup>	23.7	580	-	24	64	1.62	1963	0.16
<i>Bensour-j</i>	tetrataenite <sup>(0, 1)</sup>	102.4	580	46.8	25	64	1.62	1963	0.16
<i>Pultusk</i>	kamacite <sup>(0)</sup>	64.2	760	600.0	10	27	26.0	303	0.007
<i>Saratov</i>	tetrataenite <sup>(0)</sup>	54.1	580	633.0	70	162	35.8	16540	0.03
<b>Rumuruti chondrites</b>									
<i>NWA 753</i>	pyrrhotite <sup>(0, 15)</sup>	211.9	325	8.7	108	134	1.68	93	0.41
<b>TERRESTRIAL ROCKS AND MINERALS</b>									
<b>Basalts</b>									
<i>ba</i>	Ti-magn <sup>(9)</sup>	59.5	50	16.1	15	18	3.54	622	0.16
<i>ba (TRM)</i>	Ti-magn <sup>(9)</sup>	405.0	50	16.1	15	18	3.54	622	0.16
<i>bb-a</i>	Ti-magn <sup>(0, 6)</sup>	327.8	60/150	16.1	8	14	2.29	866	0.18
<i>bb-a (TRM)</i>	Ti-magn <sup>(0, 6)</sup>	327.3	60/150	16.1	8	14	2.29	866	0.18
<i>bb-b (NRM)</i>	Ti-magn <sup>(0, 6)</sup>	392.3	60/150	16.1	9	14	2.29	866	0.18
<i>be-3a</i>	Ti-magn <sup>(3, 10)</sup>	267.7	245	10.8	13	18	2.57	1700	0.13
<i>pd6-2-1</i>	Ti-magn <sup>(0, 8)</sup>	30.8	280	109.0	15	27	1.86	1827	0.23
<i>pd6-2-4</i>	Ti-magn <sup>(0, 8)</sup>	51.2	280	131.0	11	21	1.79	1833	0.21
<b>Andesites</b>									
<i>au1b</i>	Ti-magn <sup>(0, 5)</sup>	226.2	530	121.4	8	16	4.24	1828	0.03
<i>cug1b</i>	Ti-magn <sup>(0, 5)</sup>	175.5	550	88.7	7	14	4.65	1048	0.03
<i>osb10b</i>	magnetite <sup>(0, 5)</sup>	125.3	575	9.74	40	69	2.10	139	0.34
<b>Ignimbrites</b>									
<i>spi3301</i>	Ti-magn <sup>(0, 5)</sup>	302.8	560	73.0	9	16	2.81	545	0.11
<i>ona12</i>	Ti-magn <sup>(0, 5)</sup>	109.4	560	45.4	24	44	2.86	787	0.12
<i>spi3903</i>	magnetite <sup>(0, 5)</sup>	233.0	575	54.1	16	27	2.79	621	0.13
<i>mtd5b</i>	magnetite <sup>(0, 5)</sup>	162.3	575	93.7	22	40	2.37	1356	0.18
<i>iro8</i>	magnetite <sup>(0, 5)</sup>	161.0	575	13.6	31	48	2.03	151	0.27
<b>Rhyolites</b>									
<i>rb7a</i>	hematite <sup>(16)</sup>	238.0	650	0.03	>150	406	3.56	5	0.48
<b>Radiolarites</b>									
<i>radiol-1</i>	hematite <sup>(0)</sup>	333.5	675	1.4	>150	390	1.21	67	0.68

Sample	Main magnetic carrier and ref.	<i>m</i>	$T_C$	$\chi_0$	MDF <sub>i</sub>	$B_{cr}$	$B_{cr}/B_c$	$M_s$	$M_{rs}/M_s$
<i>radiol-2</i>	hematite <sup>(0)</sup>	232.1	675	1.6	>150	347	1.30	74	0.69
<b>Granites</b>									
<i>bf0703</i>	magnetite <sup>(0,2)</sup>	304.6	575	11.6	39	68	2.98	165	0.15
<i>bf3201</i>	magnetite <sup>(0,2)</sup>	425.5	575	41.3	7	13	7.54	448	0.01
<i>bf9804</i>	magnetite <sup>(0,2)</sup>	453.3	575	8.8	13	25	6.01	112	0.03
<i>bf8703</i>	magnetite <sup>(0,2)</sup>	228.0	575	3.8	34	61	2.08	76	0.24
<b>Microdiorite</b>									
<i>est</i>	magnetite <sup>(4)</sup>	320.0	575	13.5	8	19	10.3	128	0.01
<b>Schist</b>									
<i>sb3a</i>	pyrrhotite <sup>(4)</sup>	243.3	280/320	0.3	17	31	1.29	91	0.50
<b>Jasper</b>									
<i>jas</i>	hematite <sup>(0)</sup>	210.0	675	4.1	>150	289	1.38	154	0.70
<b>Obsidian</b>									
<i>kil-2</i>	Ti-magn <sup>(0)</sup>	219.4	142	4.4	21	27	1.34	822	0.45
<b>Minerals (monocrystals)</b>									
<i>98080</i>	pyrrhotite <sup>(0,7)</sup>	429	325	11.8	4	4	0.88	1444	0.46
<i>127037</i>	pyrrhotite <sup>(0,7)</sup>	24.5	325	6.2	3	7	1.51	5696	0.15
<i>goethite</i>	goethite <sup>(0,14)</sup>	320.1	~120	0.3	>150	>9000	-	-	-
<b>Sediments</b>									
<i>greig-tw1</i>	greigite <sup>(17)</sup>	5.0	330	970	59	80	1.38	19470	0.52
<i>greig-it1</i>	greigite <sup>(18)</sup>	4.1	330	1408	52	73	1.45	29073	0.45
SYNTHETIC SAMPLES of dispersed powders in epoxy resin									
<i>pyr-a</i> (20.5; 5.2)	pyrrhotite <sup>(0,12)</sup>	33.5	325	175	7	17	1.73	-	0.21
<i>pyr-b</i> (13.1; 3.4)	pyrrhotite <sup>(0,12)</sup>	32.8	325	69.2	11	23	1.51	-	0.32
<i>magn1a</i> (0.3; 0.1)	magnetite <sup>(0)</sup>	170.0	575	15.1	15	32	3.22	-	0.08
<i>magn6a</i> (17.3; 4)	magnetite <sup>(0)</sup>	73.6	575	-	14	28	3.02	-	0.09
<i>magn6c</i> (0.8; 0.2)	magnetite <sup>(0)</sup>	89.4	575	-	15	29	3.03	-	0.09
<i>magn6d</i> (0.5; 0.1)	magnetite <sup>(0)</sup>	79.4	575	-	15	30	3.10	-	0.09
<i>iron-2</i> (2.5; 0.4)	iron <sup>(0)</sup>	229.5	753	281	8	22	13.8	-	0.004
<i>MD hem</i> (2.1; 0.5)	hematite <sup>(0)</sup>	116.1	675	0.95	67	33	1.11	-	0.57
<i>SD hem</i>	hematite <sup>(0)</sup>	155.6	675	-	>100	177	1.43	-	0.73

*m* is mass (in mg).  $T_C$  is Curie temperature (in °C); theoretical value when italicized.  $\chi_0$  is low field magnetic susceptibility (in  $10^{-6} \text{ m}^3/\text{kg}$ ). MDF<sub>i</sub> is median destructive field of IRM (in mT); 9T IRM for hematite-bearing and goethite samples and 3T IRM for all other samples.  $B_c$  and  $B_{cr}$  are magnetic coercivity and coercivity of remanence, respectively (in mT).  $M_s$  and  $M_{rs}$  are saturation and saturation remanent magnetization (in  $10^{-3} \text{ Am}^2/\text{kg}$ ). “Ti-magn” is titanomagnetite. For synthetic samples numbers between brackets (1<sup>st</sup> column) correspond to estimated mass and volume concentrations of powders in the sample respectively (in %) and mass values correspond to the mass of the whole samples of dispersed powder with epoxy resin matrix. In the second column the information between brackets

---

corresponds to reference(s) where samples are described and/ or their magnetic properties measured. <sup>(0)</sup> this study; <sup>(1-6)</sup> Gattacceca et al., 2003, 2004, 2006, 2007a, 2007b and 2008, respectively; <sup>(7-8)</sup> Louzada et al., 2007, 2008; <sup>(9-15)</sup> Rochette et al., 1993, 1998, 2001, 2003, 2005a, 2005b, 2008, respectively; <sup>(16)</sup> Vlag. et al., 1997; <sup>(17, 18)</sup> {Hornig et al., 1998; Jiang et al., 2001} and {Florindo et al., 1995; Van Dongen et al., 2007}, respectively.

---

Accepted Manuscript

**Table 2.**

Synthesis of results on pressure demagnetization experiments.

Sample	$SIRM_1$	$IRM_{p2}$	$\Delta$	$IRM_{PR}$	$\delta$	$SIRM_2$	MDS	$\alpha$	$\epsilon_1$
<i>pressure cell</i> <sup>(1)</sup>	0.0343	0.0433	-	-	-	-	-	-	-
METEORITES									
<i>Los Angeles</i>	11.9	9.11	23	3.08	3.1	9.20	2.5	1.3	21(67)
<i>NWA 1068</i>	25.3	21.1	17	19.8	3.2	24.6	3.7	0.8	36(20)
<i>NWA 998</i>	7.97	7.47	6	6.25	-0.4	7.36	9.5	1.1	69(15)
<i>Bensour-6a</i>	1.36	1.10	19	1.01	-3.7	1.57	3.1	0.8	80(36)
<i>Bensour-i</i>	6.81	6.60	3	6.49	2.1	6.28	22.4	1.3	-
<i>Bensour-j</i>	32.0	30.7	4	30.6	-0.9	32.0	13.3	1.0	46(4)
<i>Pultusk</i>	15.3	10.2	33	9.89	0	16.0	1.8	1.3	98(38)
<i>Saratov</i>	20.3	19.6	3	18.5	0.5	-	18.9	0.8	20(16)
<i>NWA 753</i>	7.80	7.05	10	6.94	1.3	7.65	6.5	1.0	44(9)
TERRESTRIAL ROCKS AND MINERALS									
<i>ba</i>	6.78	3.12	54	3.56	12.5	6.13	1.07	1.7	29(42)
<i>ba</i> <sup>(2)</sup>	<u>5.52</u>	<u>3.64</u>	<u>34</u>	-	<u>10.9</u>	-	<u>1.7</u>	<u>1.0</u>	-
<i>bb-a</i>	48.3	24.9	48	25.7	1.9	52.5	1.26	1.4	95(51)
<i>bb-a</i> <sup>(2)</sup>	2.12	1.11	48	1.63	5.1	52.5	1.26	1.5	4(97)
<i>bb-b</i> <sup>(3)</sup>	1.62	0.96	40	0.91	9.1	2.12	1.5	1.0	72(57)
<i>be-3a</i>	74.9	32.1	57	36.9	6.8	71.7	1.08	-	91(48)
<i>pd6-2-1</i>	12.1	8.51	30	8.91	3.9	12.1	2.6	1.5	99(26)
<i>pd6-2-4</i>	18.5	11.1	40	10.6	2.2	19.1	1.6	1.4	97(45)
<i>au1b</i>	13.1	7.55	42	7.62	0.3	12.7	1.4	1.3	-
<i>cug1b</i>	5.62	3.04	46	2.62	-6.9	5.92	1.29	1.2	88(56)
<i>osb10b</i>	5.64	3.89	31	4.22	5.7	5.91	2.6	1.6	59(29)
<i>spi 3301</i>	19.1	13.2	31	10.4	-7.3	16.5	1.9	1.3	81(37)
<i>ona12</i>	10.4	8.91	14	8.72	0.2	10.4	4.2	1.1	89(16)
<i>spi3903</i>	18.1	12.4	31	12.1	1.7	18.3	2.7	1.6	75(34)
<i>mtd5b</i>	38.0	33.0	13	37.5	-3.9	37.2	5.1	1.4	75(19)
<i>iro8</i>	6.37	6.05	5	5.73	-0.2	6.20	12.4	0.8	88(8)
<i>rb7a</i>	0.55	0.40	27	0.44	8.9	0.60	2.1	1.2	14(27)
<i>radiol-1</i>	17.9	11.9	34	11.7	0.0	18.7	2.3	1.7	3(38)
<i>radiol-2</i>	13.2	8.53	35	9.45	8.1	13.5	2.0	1.7	6(30)
<i>bf0703</i>	9.47	8.22	13	7.80	-2.5	8.47	4.7	1.1	-
<i>bf3201</i>	2.76	0.95	66	0.75	-4.6	2.72	0.54	1.8	65(73)
<i>bf9804</i>	1.41	0.77	46	0.73	-3.9	1.54	1.5	1.7	66(53)
<i>bf8703</i>	4.14	3.92	5	3.79	-1.7	4.13	11.9	1.2	61(8)
<i>est</i>	8.09	1.32	84	0.98	-0.5	8.17	0.19	2.4	43(88)
<i>sb3a</i>	15.5	12.2	22	11.8	5.8	20.3	3.7	0.9	25(42)

Sample	$SIRM_1$	$IRM_{p_2}$	$\Delta$	$IRM_{PR}$	$\delta$	$SIRM_2$	MDS	$\alpha$	$\epsilon_1$
<i>jas</i>	24.3	16.9	30	18.2	6.6	23.9	2.1	1.4	5(23)
<i>kil-2</i>	46	20.1	56	29.3	19.3	47.3	0.77	1.7	63(38)
98080	31.3	18.0	42	18.9	2.9	31.9	1.28	0.2	-
127037	20.4	16.4	20	14.8	2.9	19.9	2.8	0.9	-
<i>goethite</i>	1.20	1.20	0	1.12	-2.0	1.35	-	-	-
<i>greig-tw1</i>	33.4	24.8	26	25.4	3.9	47.7	6.31	1.9	4(47)
<i>greig-it1</i>	42.6	38.5	10	29.4	0	55.9	6.87	0.9	-(48)
SYNTHETIC SAMPLES of dispersed powders in epoxy resin									
<i>pyr-a</i>	35.0	25.7	27	27.0	6.9	37.4	2.9	1.6	83(28)
<i>pyr-b</i>	26.8	19.0	29	18.1	7.8	25.7	3.2	1.8	83(30)
<i>magn1a</i>	4.77	2.05	57	2.14	4.2	4.82	0.96	1.8	78(56)
<i>magn6a</i>	94.2	43.3	54	45.2	2.8	103	0.98	1.9	83(56)
<i>magn6c</i>	6.44	2.68	58	-	5.0	6.45	0.84	-	-
<i>magn6d</i>	3.20	1.33	58	1.33	-0.2	3.20	0.88	-	-
<i>iron-2</i>	12.8	2.18	83	1.36	-6.0	11.9	0.22	2.2	20(89)
<i>MD hem</i>	2.33	0.97	58	1.03	3.4	2.52	1.10	1.3	12(59)
<i>SD hem</i>	3.92	2.43	38	2.76	9.3	3.73	1.67	1.06	14(26)

All SIRM and IRM values are expressed in  $\mu\text{Am}^2$ ;  $SIRM_1$  is the initial SIRM of the sample (before compression) in the pressure cell (at zero pressure);  $IRM_{p_2}$  is residual IRM under maximum pressure  $p_2=1.24$  GPa (inside the cell);  $\Delta$  (in %) is pressure demagnetization degree under  $p_2$ ;  $IRM_{PR}$  is residual IRM after decompression from  $p_2$  and extraction of the sample from the cell.  $\delta$  (in %) corresponds to changes in IRM upon decompression from  $p_2$  (IRM decreases when  $\delta$  is negative and increases when  $\delta$  is positive).  $SIRM_2$  is SIRM acquired after decompression from  $p_2$  and new saturation; MDS is median destructive stress (in GPa); it is italicized when linear extrapolation of pressure demagnetization curves was used for MDS determination. In the right column numbers between brackets correspond to  $\epsilon_0$  values at 0 mT (in %).  $\alpha = [(SIRM_0 - IRM_{p_1}) / (SIRM_0 - IRM_{p_2})] / [p_1 / p_2]$ , where  $p_1 = 0.46$  GPa;  $\epsilon_1 = 1 - \epsilon(30 \text{ mT}) / \epsilon_0$ , where  $\epsilon(B) = [IRM_B(B) - IRM_{BP}(B)] / IRM_B(B)$ ,  $\epsilon_0 = \epsilon(0 \text{ mT})$  and  $B$  is alternating field (see text).

<sup>(1)</sup> Values of remanent magnetization correspond to the NRM of the cell (that was never saturated);

<sup>(2)</sup> The initially compressed magnetization was TRM; <sup>(3)</sup> The initially compressed magnetization was NRM

**Table 3.** Parameters related to pressure sensitivity of different magnetic mineralogies.

Magnetic mineralogy	$p_1=0.46$ GPa					$p_2=1.24$ GPa					$B_{th}$ (mT)
	$a_1$	$b_1$	$r_1$	$r_1^*$	$R^2_1$	$a_2$	$b_2$	$r_2$	$r_2^*$	$R^2_2$	
pyrrhotite	0.005	0.90	0.38	0.39	0.01	0.06	0.56	0.73	0.71	0.63	110036
nickel iron	0.14	0.42	0.88	0.81	0.82	0.35	-0.49	1.00	0.99	1.00	704
hematite	0.04	0.60	0.53	0.08	0.43	0.11	0.04	0.90	0.59	0.93	6100073
(Ti)magnetite	0.15	0.34	0.65	0.57	0.47	0.27	-0.22	0.74	0.66	0.63	10099

Residual isothermal remanent magnetization under pressure normalized to its initial SIRM ( $IRM_p$ ) can be calculated for  $p_1=0.46$  GPa and  $p_2=1.24$  GPa using the following empirical equation:  $IRM_{px}/SIRM = a_x \cdot \ln(B_{cr}) + b_x$ , where  $x=1$  for  $p_1$  and  $x=2$  for  $p_2$ ;  $B_{cr}$  is coercivity of remanence in mT.  $r_x$  and  $r_x^*$  are Pearson correlation coefficients indicating the strength of linear dependences between  $IRM_{px}/SIRM$  and  $B_{cr}$ , as well as  $IRM_{px}/SIRM$  and  $B_c$ , respectively. Pearson's correlation is determined as a ration of covariance of the two variables to the product of their standard deviation.  $B_c$  is magnetic coercivity.  $R^2_x$  is the coefficient of determination (R-squared value), it ranges from 0 to 1 and reveals how closely the logarithmic fit  $IRM_{px}=f(B_{cr})$  corresponds to the actual data. The calculated  $R^2_1$  and  $R^2_2$  are correlation coefficient between  $IRM_p$  and  $B_{cr}$  and determination coefficient of logarithmic fits  $IRM_{px}=f(B_{cr})$ .  $r_x^*$  is correlation coefficient for the case when  $B_{cr}$  is replaced by  $B_c$ , where  $B_c$  is magnetic coercivity. is not an adjusted R-squared value (the transformed regression model is used for calculations).  $B_{th}$  is threshold  $B_{cr}$  above which no demagnetization under  $p_2$  is possible.  $B_{th} = e^{(1-b)/a}$ .

Formatted: English (U.S.)

Formatted: English (U.S.)

Formatted: Font: Italic

Formatted: Subscript

Formatted: Superscript

Formatted: Subscript

Formatted: Font: Italic

Formatted: Subscript

Formatted: Font: Italic

Formatted: Subscript

Formatted: Font: Italic

Formatted: Superscript



## TABLES

Table 1

Main magnetic properties of investigated samples.

Sample	Main magnetic carrier and ref.	$m$	$T_C$	$\chi_0$	$MDF_i$	$B_{cr}$	$B_{cr}/B_c$	$M_s$	$M_{rs}/M_s$
METEORITES									
<b>Martian meteorites</b>									
<i>Los Angeles</i>	Ti-magn <sup>(11, 13)</sup>	94.3	150	10.3	31	55	1.41	1232	0.49
<i>NWA 1068</i>	pyrrhotite <sup>(13, 11)</sup>	240.2	325	1.3	100	134	1.54	212	0.47
<i>NWA 998</i>	magnetite <sup>(13, 11)</sup>	20.4	575	4.3	25	41	1.73	713	0.24
<b>Ordinary chondrites</b>									
<i>Bensour-6a</i>	taenite <sup>(0, 1)</sup>	162.0	450	154.0	18	33	35.8	3187	0.003
<i>Bensour-i</i>	tetrataenite <sup>(0, 1)</sup>	23.7	580	-	24	64	1.62	1963	0.16
<i>Bensour-j</i>	tetrataenite <sup>(0, 1)</sup>	102.4	580	46.8	25	64	1.62	1963	0.16
<i>Pultusk</i>	kamacite <sup>(0)</sup>	64.2	760	600.0	10	27	26.0	303	0.007
<i>Saratov</i>	tetrataenite <sup>(0)</sup>	54.1	580	633.0	70	162	35.8	16540	0.03
<b>Rumuruti chondrites</b>									
<i>NWA 753</i>	pyrrhotite <sup>(0, 15)</sup>	211.9	325	8.7	108	134	1.68	93	0.41
TERRESTRIAL ROCKS AND MINERALS									
<b>Basalts</b>									
<i>ba</i>	Ti-magn <sup>(9)</sup>	59.5	50	16.1	15	18	3.54	622	0.16
<i>ba (TRM)</i>	Ti-magn <sup>(9)</sup>	405.0	50	16.1	15	18	3.54	622	0.16
<i>bb-a</i>	Ti-magn <sup>(0, 6)</sup>	327.8	60/150	16.1	8	14	2.29	866	0.18
<i>bb-a (TRM)</i>	Ti-magn <sup>(0, 6)</sup>	327.3	60/150	16.1	8	14	2.29	866	0.18
<i>bb-b (NRM)</i>	Ti-magn <sup>(0, 6)</sup>	392.3	60/150	16.1	9	14	2.29	866	0.18
<i>be-3a</i>	Ti-magn <sup>(3, 10)</sup>	267.7	245	10.8	13	18	2.57	1700	0.13
<i>pd6-2-1</i>	Ti-magn <sup>(0, 8)</sup>	30.8	280	109.0	15	27	1.86	1827	0.23
<i>pd6-2-4</i>	Ti-magn <sup>(0, 8)</sup>	51.2	280	131.0	11	21	1.79	1833	0.21
<b>Andesites</b>									
<i>au1b</i>	Ti-magn <sup>(0, 5)</sup>	226.2	530	121.4	8	16	4.24	1828	0.03
<i>cug1b</i>	Ti-magn <sup>(0, 5)</sup>	175.5	550	88.7	7	14	4.65	1048	0.03
<i>osb10b</i>	magnetite <sup>(0, 5)</sup>	125.3	575	9.74	40	69	2.10	139	0.34
<b>Ignimbrites</b>									
<i>spi3301</i>	Ti-magn <sup>(0, 5)</sup>	302.8	560	73.0	9	16	2.81	545	0.11
<i>ona12</i>	Ti-magn <sup>(0, 5)</sup>	109.4	560	45.4	24	44	2.86	787	0.12
<i>spi3903</i>	magnetite <sup>(0, 5)</sup>	233.0	575	54.1	16	27	2.79	621	0.13
<i>mtd5b</i>	magnetite <sup>(0, 5)</sup>	162.3	575	93.7	22	40	2.37	1356	0.18
<i>iro8</i>	magnetite <sup>(0, 5)</sup>	161.0	575	13.6	31	48	2.03	151	0.27
<b>Rhyolites</b>									
<i>rb7a</i>	hematite <sup>(16)</sup>	238.0	650	0.03	>150	406	3.56	5	0.48
<b>Radiolarites</b>									
<i>radiol-1</i>	hematite <sup>(0)</sup>	333.5	675	1.4	>150	390	1.21	67	0.68

Sample	Main magnetic carrier and ref.	$m$	$T_C$	$\chi_0$	MDF <sub>i</sub>	$B_{cr}$	$B_{cr}/B_c$	$M_s$	$M_{rs}/M_s$
<i>radiol-2</i>	hematite <sup>(0)</sup>	232.1	675	1.6	>150	347	1.30	74	0.69
<b>Granites</b>									
<i>bf0703</i>	magnetite <sup>(0, 2)</sup>	304.6	575	11.6	39	68	2.98	165	0.15
<i>bf3201</i>	magnetite <sup>(0, 2)</sup>	425.5	575	41.3	7	13	7.54	448	0.01
<i>bf9804</i>	magnetite <sup>(0, 2)</sup>	453.3	575	8.8	13	25	6.01	112	0.03
<i>bf8703</i>	magnetite <sup>(0, 2)</sup>	228.0	575	3.8	34	61	2.08	76	0.24
<b>Microdiorite</b>									
<i>est</i>	magnetite <sup>(4)</sup>	320.0	575	13.5	8	19	10.3	128	0.01
<b>Schist</b>									
<i>sb3a</i>	pyrrhotite <sup>(4)</sup>	243.3	280/320	0.3	17	31	1.29	91	0.50
<b>Jasper</b>									
<i>jas</i>	hematite <sup>(0)</sup>	210.0	675	4.1	>150	289	1.38	154	0.70
<b>Obsidian</b>									
<i>kil-2</i>	Ti-magn <sup>(0)</sup>	219.4	142	4.4	21	27	1.34	822	0.45
<b>Minerals (monocrystals)</b>									
<i>98080</i>	pyrrhotite <sup>(0, 7)</sup>	429	325	11.8	4	4	0.88	1444	0.46
<i>127037</i>	pyrrhotite <sup>(0, 7)</sup>	24.5	325	6.2	3	7	1.51	5696	0.15
<i>goethite</i>	goethite <sup>(0, 14)</sup>	320.1	~120	0.3	>150	>9000	-	-	-
<b>Sediments</b>									
<i>greig-tw1</i>	greigite <sup>(17)</sup>	5.0	330	970	59	80	1.38	19470	0.52
<i>greig-it1</i>	greigite <sup>(18)</sup>	4.1	330	1408	52	73	1.45	29073	0.45
SYNTHETIC SAMPLES of dispersed powders in epoxy resin									
<i>pyr-a</i> (20.5; 5.2)	pyrrhotite <sup>(0, 12)</sup>	33.5	325	175	7	17	1.73	-	0.21
<i>pyr-b</i> (13.1; 3.4)	pyrrhotite <sup>(0, 12)</sup>	32.8	325	69.2	11	23	1.51	-	0.32
<i>magn1a</i> (0.3; 0.1)	magnetite <sup>(0)</sup>	170.0	575	15.1	15	32	3.22	-	0.08
<i>magn6a</i> (17.3; 4)	magnetite <sup>(0)</sup>	73.6	575	-	14	28	3.02	-	0.09
<i>magn6c</i> (0.8; 0.2)	magnetite <sup>(0)</sup>	89.4	575	-	15	29	3.03	-	0.09
<i>magn6d</i> (0.5; 0.1)	magnetite <sup>(0)</sup>	79.4	575	-	15	30	3.10	-	0.09
<i>iron-2</i> (2.5; 0.4)	iron <sup>(0)</sup>	229.5	753	281	8	22	13.8	-	0.004
<i>MD hem</i> (2.1; 0.5)	hematite <sup>(0)</sup>	116.1	675	0.95	67	33	1.11	-	0.57
<i>SD hem</i>	hematite <sup>(0)</sup>	155.6	675	-	>100	177	1.43	-	0.73

$m$  is mass (in mg).  $T_C$  is Curie temperature (in °C); theoretical value when italicized.  $\chi_0$  is low field magnetic susceptibility (in  $10^{-6}m^3/kg$ ). MDF<sub>i</sub> is median destructive field of IRM (in mT): 9T IRM for hematite-bearing and goethite samples and 3T IRM for all other samples.  $B_c$  and  $B_{cr}$  are magnetic coercivity and coercivity of remanence, respectively (in mT).  $M_s$  and  $M_{rs}$  are saturation and saturation remanent magnetization (in  $10^{-3} Am^2/kg$ ). “Ti-magn” is titanomagnetite. For synthetic samples numbers between brackets (1<sup>st</sup> column) correspond to estimated mass and volume concentrations of powders in the sample respectively (in %) and mass values correspond to the mass of the whole samples of dispersed powder with epoxy resin matrix. In the second column the information between brackets

---

corresponds to reference(s) where samples are described and/ or their magnetic properties measured. <sup>(0)</sup> this study; <sup>(1-6)</sup> Gattacceca et al., 2003, 2004, 2006, 2007a, 2007b and 2008, respectively; <sup>(7-8)</sup> Louzada et al., 2007, 2008; <sup>(9-15)</sup> Rochette et al., 1993, 1998, 2001, 2003, 2005a, 2005b, 2008, respectively; <sup>(16)</sup> Vlag. et al., 1997; <sup>(17, 18)</sup> {Horng et al., 1998; Jiang et al., 2001} and {Florindo et al., 1995; Van Dongen et al., 2007}, respectively.

---

Accepted Manuscript

**Table 2.**

Synthesis of results on pressure demagnetization experiments.

Sample	$SIRM_1$	$IRM_{p2}$	$\Delta$	$IRM_{PR}$	$\delta$	$SIRM_2$	MDS	$\alpha$	$\epsilon_1$
<i>pressure cell</i> <sup>(1)</sup>	0.0343	0.0433	-	-	-	-	-	-	-
METEORITES									
<i>Los Angeles</i>	11.9	9.11	23	3.08	3.1	9.20	2.5	1.3	21(67)
<i>NWA 1068</i>	25.3	21.1	17	19.8	3.2	24.6	3.7	0.8	36(20)
<i>NWA 998</i>	7.97	7.47	6	6.25	-0.4	7.36	9.5	1.1	69(15)
<i>Bensour-6a</i>	1.36	1.10	19	1.01	-3.7	1.57	3.1	0.8	80(36)
<i>Bensour-i</i>	6.81	6.60	3	6.49	2.1	6.28	22.4	1.3	-
<i>Bensour-j</i>	32.0	30.7	4	30.6	-0.9	32.0	13.3	1.0	46(4)
<i>Pultusk</i>	15.3	10.2	33	9.89	0	16.0	1.8	1.3	98(38)
<i>Saratov</i>	20.3	19.6	3	18.5	0.5	-	18.9	0.8	20(16)
<i>NWA 753</i>	7.80	7.05	10	6.94	1.3	7.65	6.5	1.0	44(9)
TERRESTRIAL ROCKS AND MINERALS									
<i>ba</i>	6.78	3.12	54	3.56	12.5	6.13	1.07	1.7	29(42)
<i>ba</i> <sup>(2)</sup>	5.52	3.64	34	-	10.9	-	1.7	1.0	-
<i>bb-a</i>	48.3	24.9	48	25.7	1.9	52.5	1.26	1.4	95(51)
<i>bb-a</i> <sup>(2)</sup>	2.12	1.11	48	1.63	5.1	52.5	1.26	1.5	4(97)
<i>bb-b</i> <sup>(3)</sup>	1.62	0.96	40	0.91	9.1	2.12	1.5	1.0	72(57)
<i>be-3a</i>	74.9	32.1	57	36.9	6.8	71.7	1.08	-	91(48)
<i>pd6-2-1</i>	12.1	8.51	30	8.91	3.9	12.1	2.6	1.5	99(26)
<i>pd6-2-4</i>	18.5	11.1	40	10.6	2.2	19.1	1.6	1.4	97(45)
<i>au1b</i>	13.1	7.55	42	7.62	0.3	12.7	1.4	1.3	-
<i>cug1b</i>	5.62	3.04	46	2.62	-6.9	5.92	1.29	1.2	88(56)
<i>osb10b</i>	5.64	3.89	31	4.22	5.7	5.91	2.6	1.6	59(29)
<i>spi 3301</i>	19.1	13.2	31	10.4	-7.3	16.5	1.9	1.3	81(37)
<i>ona12</i>	10.4	8.91	14	8.72	0.2	10.4	4.2	1.1	89(16)
<i>spi3903</i>	18.1	12.4	31	12.1	1.7	18.3	2.7	1.6	75(34)
<i>mtd5b</i>	38.0	33.0	13	37.5	-3.9	37.2	5.1	1.4	75(19)
<i>iro8</i>	6.37	6.05	5	5.73	-0.2	6.20	12.4	0.8	88(8)
<i>rb7a</i>	0.55	0.40	27	0.44	8.9	0.60	2.1	1.2	14(27)
<i>radiol-1</i>	17.9	11.9	34	11.7	0.0	18.7	2.3	1.7	3(38)
<i>radiol-2</i>	13.2	8.53	35	9.45	8.1	13.5	2.0	1.7	6(30)
<i>bf0703</i>	9.47	8.22	13	7.80	-2.5	8.47	4.7	1.1	-
<i>bf3201</i>	2.76	0.95	66	0.75	-4.6	2.72	0.54	1.8	65(73)
<i>bf9804</i>	1.41	0.77	46	0.73	-3.9	1.54	1.5	1.7	66(53)
<i>bf8703</i>	4.14	3.92	5	3.79	-1.7	4.13	11.9	1.2	61(8)
<i>est</i>	8.09	1.32	84	0.98	-0.5	8.17	0.19	2.4	43(88)
<i>sb3a</i>	15.5	12.2	22	11.8	5.8	20.3	3.7	0.9	25(42)

Sample	$SIRM_1$	$IRM_{p_2}$	$\Delta$	$IRM_{PR}$	$\delta$	$SIRM_2$	MDS	$\alpha$	$\varepsilon_1$
<i>jas</i>	24.3	16.9	30	18.2	6.6	23.9	2.1	1.4	5(23)
<i>kil-2</i>	46	20.1	56	29.3	19.3	47.3	0.77	1.7	63(38)
<i>98080</i>	31.3	18.0	42	18.9	2.9	31.9	1.28	0.2	-
<i>127037</i>	20.4	16.4	20	14.8	2.9	19.9	2.8	0.9	-
<i>goethite</i>	1.20	1.20	0	1.12	-2.0	1.35	-	-	-
<i>greig-tw1</i>	33.4	24.8	26	25.4	3.9	47.7	6.31	1.9	4(47)
<i>greig-it1</i>	42.6	38.5	10	29.4	0	55.9	6.87	0.9	-(48)
SYNTHETIC SAMPLES of dispersed powders in epoxy resin									
<i>pyr-a</i>	35.0	25.7	27	27.0	6.9	37.4	2.9	1.6	83(28)
<i>pyr-b</i>	26.8	19.0	29	18.1	7.8	25.7	3.2	1.8	83(30)
<i>magn1a</i>	4.77	2.05	57	2.14	4.2	4.82	0.96	1.8	78(56)
<i>magn6a</i>	94.2	43.3	54	45.2	2.8	103	0.98	1.9	83(56)
<i>magn6c</i>	6.44	2.68	58	-	5.0	6.45	0.84	-	-
<i>magn6d</i>	3.20	1.33	58	1.33	-0.2	3.20	0.88	-	-
<i>iron-2</i>	12.8	2.18	83	1.36	-6.0	11.9	0.22	2.2	20(89)
<i>MD hem</i>	2.33	0.97	58	1.03	3.4	2.52	1.10	1.3	12(59)
<i>SD hem</i>	3.92	2.43	38	2.76	9.3	3.73	1.67	1.06	14(26)

All SIRM and IRM values are expressed in  $\mu\text{Am}^2$ ;  $SIRM_1$  is the initial SIRM of the sample (before compression) in the pressure cell (at zero pressure);  $IRM_{p_2}$  is residual IRM under maximum pressure  $p_2=1.24$  GPa (inside the cell);  $\Delta$  (in %) is pressure demagnetization degree under  $p_2$ ;  $IRM_{PR}$  is residual IRM after decompression from  $p_2$  and extraction of the sample from the cell.  $\delta$  (in %) corresponds to changes in IRM upon decompression from  $p_2$  (IRM decreases when  $\delta$  is negative and increases when  $\delta$  is positive).  $SIRM_2$  is SIRM acquired after decompression from  $p_2$  and new saturation; MDS is median destructive stress (in GPa); it is italicized when linear extrapolation of pressure demagnetization curves was used for MDS determination. In the right column numbers between brackets correspond to  $\varepsilon_0$  values at 0 mT (in %).  $\alpha=[(SIRM_0-IRM_{p_1})/(SIRM_0-IRM_{p_2})]/[p_1/p_2]$ , where  $p_1=0.46$  GPa;  $\varepsilon_1=1-\varepsilon(30 \text{ mT})/\varepsilon_0$ , where  $\varepsilon(B)=[IRM_B(B)-IRM_{BP}(B)]/IRM_B(B)$ ,  $\varepsilon_0=\varepsilon(0 \text{ mT})$  and  $B$  is alternating field (see text).

<sup>(1)</sup> Values of remanent magnetization correspond to the NRM of the cell (that was never saturated);

<sup>(2)</sup> The initially compressed magnetization was TRM; <sup>(3)</sup> The initially compressed magnetization was NRM

**Table 3.** Parameters related to pressure sensitivity of different magnetic mineralogies.

Magnetic mineralogy	$p_1=0.46$ GPa					$p_2=1.24$ GPa					
	$a_1$	$b_1$	$r_1$	$r_1^*$	$R^2_1$	$a_2$	$b_2$	$r_2$	$r_2^*$	$R^2_2$	$B_{th}$ (mT)
pyrrhotite	0.005	0.90	0.38	0.39	0.01	0.06	0.56	0.73	0.71	0.63	1100
nickel iron	0.14	0.42	0.88	0.81	0.82	0.35	-0.49	1.00	0.99	1.00	70
hematite	0.04	0.60	0.53	0.08	0.43	0.11	0.04	0.90	0.59	0.93	6100
(Ti)magnetite	0.15	0.34	0.65	0.57	0.47	0.27	-0.22	0.74	0.66	0.63	100

Residual isothermal remanent magnetization under pressure normalized to its initial SIRM ( $IRM_p$ ) can be calculated for  $p_1=0.46$  GPa and  $p_2=1.24$  GPa using the following empirical equation:  $IRM_{px}/SIRM = a_x \cdot \ln(B_{cr}) + b_x$ , where  $x=1$  for  $p_1$  and  $x=2$  for  $p_2$ ;  $B_{cr}$  is coercivity of remanence in mT.  $r_x$  and  $r_x^*$  are Pearson correlation coefficients indicating the strength of linear dependences between  $IRM_{px}/SIRM$  and  $B_{cr}$  as well as  $IRM_{px}/SIRM$  and  $B_c$ , respectively. Pearson's correlation is determined as a ration of covariance of the two variables to the product of their standard deviation.  $B_c$  is magnetic coercivity.  $R^2_x$  is the coefficient of determination (R-squared value), it ranges from 0 to 1 and reveals how closely the logarithmic fit  $IRM_{px}=f(B_{cr})$  corresponds to the actual data. The calculated  $R^2$  is not an adjusted R-squared value (the transformed regression model is used for calculations).  $B_{th}$  is threshold  $B_{cr}$  above which no demagnetization under  $p_2$  is possible.  $B_{th} = e^{(1-b)/a}$ .