



HAL
open science

Predictive Encoder and Buffer Control for Statistical Multiplexing of Multimedia Contents

Nesrine Changuel, Bessem Sayadi, Michel Kieffer

► **To cite this version:**

Nesrine Changuel, Bessem Sayadi, Michel Kieffer. Predictive Encoder and Buffer Control for Statistical Multiplexing of Multimedia Contents. 2011. hal-00614576v1

HAL Id: hal-00614576

<https://hal.science/hal-00614576v1>

Preprint submitted on 12 Aug 2011 (v1), last revised 4 Sep 2012 (v2)

HAL is a multi-disciplinary open access archive for the deposit and dissemination of scientific research documents, whether they are published or not. The documents may come from teaching and research institutions in France or abroad, or from public or private research centers.

L'archive ouverte pluridisciplinaire **HAL**, est destinée au dépôt et à la diffusion de documents scientifiques de niveau recherche, publiés ou non, émanant des établissements d'enseignement et de recherche français ou étrangers, des laboratoires publics ou privés.

Predictive Encoder and Buffer Control for Statistical Multiplexing of Multimedia Contents

Nesrine Changuel, *Student member, IEEE*, Bessem Sayadi, *member, IEEE*,
and Michel Kieffer, *Senior member, IEEE*

Abstract

Statistical multiplexing of video contents aims at transmitting several variable bit rate (VBR) encoded video streams over a band-limited channel. Rate-distortion (RD) models for the encoded streams are often used to control the video encoders. Buffering at the output of encoders is one of the several techniques used to smooth out the fluctuating bit rate of compressed video due to variations in the activity of video contents. In this paper, a statistical multiplexer is proposed where a closed-loop control of both video encoders and buffers is performed jointly. First, a predictive joint video encoder controller accounting for minimum quality, fairness, and smoothness constraints is considered. Second, all buffers are controlled simultaneously to regulate the buffering delays. This delay is adjusted according to a reference delay constraint. The main idea is to update the encoding rate for each video unit according to the average level of the buffers, to maximize the quality of each program and effectively use the available channel rate. Simulation results show that the proposed scheme yields a smooth and fair video quality among programs thanks to the predictive control. A similar buffering delay for all programs and an efficient use of the available channel rate are ensured thanks to the buffer management and to the predictive closed-loop control.

Index Terms

Buffer storage, Video codecs, Predictive control, Multiplexing, Digital video broadcasting

I. INTRODUCTION

Video services on communication networks, such as video-on-demand, digital television, video streaming, or video conferencing, have emerged in the last few years. For example, Digital Video Broadcasting-Satellite Handheld (DVB-SH) [1] or Multimedia Broadcast Multicast Services (MBMS) [2] targets the delivery of video programs to a large audience over a broadcast channel from the service providers to mobile users.

Due to limited bandwidth resources, video programs are compressed using efficient video encoders such as MPEG 4 [3], H.264/AVC [4], or H.264/SVC [5]. The compressed programs are then multiplexed with other contents. Two encoding modes may be considered, leading to two types of multiplexing. Constant Bit Rate (CBR) encoding leads to an equal distribution of the channel rate between programs without any consideration about their respective complexity. This scheme is simple, but the quality may vary significantly with time within a single program and between programs. Encoding with Variable Bit Rate (VBR) [6] allows a simpler program to be encoded with a low rate leaving additional rate to other programs with more complex contents, *e.g.*, action motion pictures. The purpose of *statistical multiplexing* (SM) [7] is then to share efficiently the channel rate between programs via a dynamic adjustment of the coding rate of each program.

Apart from the optimal use of the available channel rate, SM systems may target the satisfaction of several constraints linked to the quality-of-service (QoS) of the delivered programs, including video quality and transmission delay. For example, SM systems may be designed in such a way that

- programs are encoded with a minimum quality (*minimum quality* constraint [8]),
- programs are encoded with similar quality (*fairness* constraint [9]),
- the quality of each decoded program varies smoothly with time (*smoothness* constraint [10]),
- latency at the receiver side, including switching between programs, is minimized [11].

Finding a SM system able to satisfy simultaneously all these constraints in the context of video broadcasting is still a challenging task. This is mainly due to the non-stationary content of each program. Variations may be due, *e.g.*, to scene change or to high activity within a program. In this paper, we propose a SM system that allows transmission of several video programs over a broadcast channel while taking into account the minimum quality, the fairness, and the smoothness constraints as well as the transmission delay constraint.

A. Related works

The availability of well-tuned Rate-Distortion (RD) or complexity models for each program is very useful to satisfy the previously-mentioned constraints. These models can be obtained using the *feedback* approach, where RD statistics generated by the encoder are used to control the future bit-rate allocation, or using the *look-ahead* approach, where RD statistics computed by a preprocessor are used to adjust the bit rate *prior* to coding the frames in question. These two approaches are discussed in [18].

SM	Constraints				Buffer control		Long term control	Solution
	Channel rate	Min quality	Fairness	Smoothness	Bits	VU		
[11]	X				X			Analytical
[12]	X				X	X		NLO
[13]	X				X			Stochastic optimization
[8], [10]	X		(X)	X	X			ALO
[14]	X		(X)	(X)	X			Analytical
[15]	X			(X)				Numerical
[16]	X		(X)	X	X			Analytical
[17]	X		(X)	(X)	X		X	Numerical
Here	X	X	X	X		X	X	NLO and ALO

Table I

SUMMARY OF THE PROPERTIES OF VARIOUS SM SYSTEMS, NLO (LAGRANGE OPTIMIZATION WITH NUMERICAL SOLUTION), ALO (LAGRANGE OPTIMIZATION WITH ANALYTIC SOLUTION)

The RD trade-off of encoded streams may be adjusted by selectively discarding frames as in [19], [20] or via the encoding parameters as in [17], [21]. In the case of scalable video encoders, *e.g.*, H.264/SVC, this control may be replaced by some packet filtering process [22], [23]. In this case, the number of transmitted enhancement layers for each frame is the control parameter. RD models, detailed in Section III, are instrumental in all cases.

Once the RD characteristics are available, one can control the encoding parameters (QP, number of skipped frames, inter-frame prediction parameter, *etc.*), using a rate control algorithms. Various algorithms have been proposed in the context of single and multiple video encoding. The rate control problem for single video is addressed in [24] by comparing the quality of previously encoded frames to that of the current frame in order to interpolate the RD characteristics and to determine the appropriate encoding parameters. However, this technique accounts only for the past and may lead to violation of quality constraints. In [16], a joint encoder and statistical multiplexer of video programs is proposed. The proposed control system allows decreasing the end-to-end delay and improving the average quality of compressed video by dynamically distributing the available bitrate between the video sources according to their relative complexity. A smooth video quality is achieved by allowing only small variations of the current frame quality compared to the average PSNR of previously encoded frames and by using a low-pass filter to smooth the QP variations. This method may lead, however, to difficulties in case of

scene change or high motion in the video programs.

To handle the complicated inter-frame dependency problem, the RD characteristics of the frames next to the one that has to be encoded are exploited in [17]. This look-ahead approach in a SM context allows getting the RD characteristics of future uncoded video frames within the look-ahead window with a moderate computational complexity. Good smoothness over frames and fairness are obtained with the proposed control system, however, these two constraints are not considered explicitly in the optimization problem which makes them difficult to be achieved with other system conditions (channel rate, scene change, etc).

Among all constraints, the smoothness is the most difficult to satisfy due to the non-stationary content of video programs. This constraint has been considered in the context of single-source video coding, *e.g.*, in [25]–[27], and in a SM context *e.g.*, in [8], [10]. The SM system proposed in [10] aims at minimizing the variance of the distortion of the encoded frames. This allows getting a better video quality in average. The encoding rate is adjusted so that the rate constraint is updated according to the level of a shared buffer achieving the target smoothness distortion constraint. However, such shared buffer hinders the control of the buffering delay for each individual multiplexed program.

The buffer control is another important issue to ensure a good use of the available channel rate and to limit the video delivery delay. Buffer control has been considered, *e.g.*, in [28]–[32]. For example, in [30] and [32], several streams are multiplexed and their transmission rates are adapted based on buffer occupancy information. This method allows a simultaneous adjustment of the rate and of the buffer occupancy, however, the buffer occupancy is controlled at a bit level which does not allow to control the transmission delay. The rate allocation method proposed in [12] minimizes the allocated resource while guaranteeing some QoS requirements. QoS is related to both buffer load and delay (probability of buffer overflow and delay violation). Rate control and buffering delay are also addressed in [11] where a technique for performing SM in conjunction with time slicing in DVB-H, implemented in the IP encapsulator is proposed. This method achieves a satisfactory use of the channel rate and a minimum buffering delay for all multiplexed programs. Nevertheless, in both [11] and [12], no constraint on the video quality is considered.

A summary of previous results concerning SM systems with the considered constraints is provided in Table I where (*X*) means that the constraint is experimentally achieved with the considered scenario but

not explicitly targeted.

B. Main contributions

In this paper, we introduce a SM system which performs a joint closed-loop control of video encoders and buffers. The control is performed at a video unit (VU) level to provide at any time instant a smooth quality between the VUs of a given program and bounded quality differences between the VUs of the multiplexed programs. The channel rate constraint and similar transmission delays for all programs are also targeted.

The parameters of all video encoders are adjusted for each VU using a *predictive control* over a window containing the previous, current, and several future VUs. This technique allows a better satisfaction of the quality constraints compared to short-term control. For that purpose, the RD characteristics of the current and future VUs have to be estimated.

The level of the buffers is adjusted via the transmission rate of each program to fully use the available channel rate and limit the buffering delay. This control is performed at the VU level contrary to most of previous works, where it is done at the bit level. Delivery and program switching delay are thus better managed. The closed-loop is obtained using a Proportional-Integral-Derivative (PID) feedback of the buffer level information to the controller of the video encoders, which allows the encoding rate constraint to be dynamically updated.

The paper is organized as follows. Section II introduces some notations and the architecture of the proposed SM system. Several state-of-art RD models are recalled in Section III before presenting the one used in the proposed system. Section IV presents the way all constraints are involved to reach good SM performance in terms of channel rate, quality, and buffering delay constraints. Section V presents the performance of the proposed SM system before concluding this work in Section VI.

II. ARCHITECTURE OF THE PROPOSED SM SYSTEM

Figure 1 presents the proposed architecture to perform SM of N video programs encoded and transmitted in parallel over a broadcast channel. Programs are assumed to be transmitted over a unidirectional broadcast channel. In this context no receiver feedback is considered, and the level of the buffers at receiver side is not available.

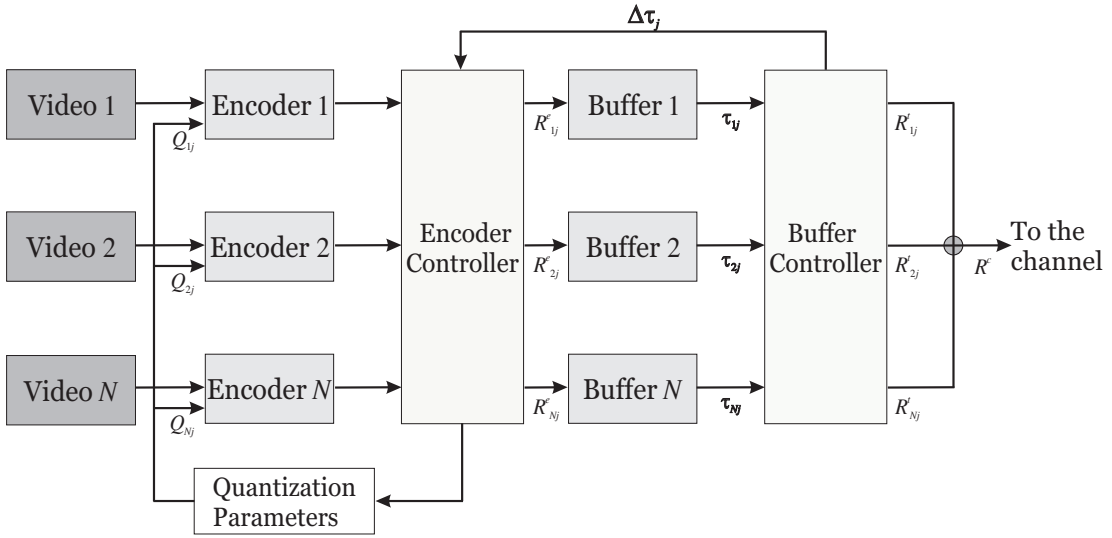

Figure 1. Proposed closed-loop statistical multiplexing system

V_{ij} is the j -th VU in the i -th video program. All VUs are assumed to have the same duration T . The frame rate F as well as the number of frames per VU is N_f are assumed constant with time and identical for all multiplexed programs. The QP Q_{ij} is the parameter used by each encoder to compress V_{ij} .

The regulation process provides one QP per VU, which is then fed to the video encoder. When VU is considered as a Group of Pictures (GoP), the encoder may use the same QP for each frame in the GoP, which provides a more or less constant quality. It may also perform an adjustment of QP for each frame around the provided value to perform a RD optimization, using the rate control algorithm, *e.g.*, the results in [27].

At each time instant j , the encoder controller determines Q_{ij} so that the encoding rates R_{ij}^e , $i = 1 \dots N$ of the N encoders satisfy some dynamically updated rate constraint R_j , defined later, while satisfying the quality constraints. At each encoder output, the i -th buffer stores temporarily N_{ij}^{VU} encoded VUs. The draining (transmission) rate R_{ij}^t from the i -th buffer is determined to satisfy the channel rate constraint R_j^c and to control each buffer delay τ_{ij} around some reference τ_0 , expressed in seconds. The differences $\tau_{ij} - \tau_0$ averaged over the N programs denoted by $\Delta\tau_j$ is fed back to the encoder controller. $\Delta\tau_j$ is used to get the rate constraint R_{j+1} . Buffers and video encoders are thus controlled in a closed loop, see Figure 1.

To control the video quality, several objective and subjective video quality measurement techniques are available, see, *e.g.*, [33]–[35] and the references therein. Here, as in most of existing works [15], [17], [22], we use the Peak-Signal-to-Noise Ratio (PSNR) metric. The PSNR of the j -th frame in the i -th

Notation	Definition	Notation	Definition
N	Number of multiplexed programs	R_j	Encoding rate constraint at time j
N_f	Number of frames per VU	S_j	Channel state at time j
T	Video unit duration	N_{ij}^{VU}	Number of VU in buffer i at time j
i	Index of the video program	B_{ij}	Bit level of the i -th buffer at time j
j	Time index	τ_{ij}	Buffer delay in the i -th buffer at time j
V_{ij}	Video unit of the i -th program at time j	τ_0	Reference delay
F_i	Frame rate of program i	$\Delta\tau_j$	Average delay deviation among programs at time j
Q_{ij}	Quantization parameter of the i -th program at time j	ΔP_{ij}^s	Smoothness constraint
R_{ij}^e	Encoding rate of the i -th program at time j	ΔP_{ij}^f	Fairness constraint
P_{ij}	PSNR of the i -th program at time j	K_p	Proportional gain in the control system
R_{ij}^t	Transmission rate of the i -th program at time j	K_i	Integral gain in the control system
R_j^c	Channel rate at time j	K_d	Derivative gain in the control system

Table II
NOTATIONS

program is $P_{ij} = 10 \log_{10} \left(\frac{255^2}{D_{ij}} \right)$ where D_{ij} is the average distortion (considering a quadratic distortion measure).

Table II summarizes the notations used in this paper.

III. RATE AND DISTORTION MODELS

Parametric RD models of the encoded VUs are very useful to perform an efficient rate control process in the context of QoS-constrained SM. First RD models were proposed in the context of video encoding, see, *e.g.*, [21], [36]–[42]. Different encoding parameters are considered such as frame rate, QP, number of skipped frames, inter-frame prediction parameters, or size of the GoP. These models may be readily used in the context of SM.

RD models may be grouped into *independent* and *dependent* models. In the first family, the RD characteristic of each VU is assumed independent of that of the other VUs. A simple model with few parameters is usually obtained, where the rate and distortion are the logarithm [38], the power [39], or the exponential [42] of some input parameters. Such models are quite efficient to represent the RD characteristics of a VU which consists of a whole GoP, or of INTRA-coded frames when a VU is a frame. The dependent RD models accounts for the impact of the RD characteristics and coding parameters of a given VU on those of the VUs taking the latter as reference, [24], [43], [44]. Dependent RD models

require usually more RD measurements to fit their parameters than independent RD models. A better accuracy is obtained at a higher computational complexity.

In what follows, a VU represents a GoP and thus, we focus on independent RD models.

A. Previous results

Most independent RD models are parametric with parameter values estimated from several encoding trials for each frame as in [36], [37] or each GoP as in [40], [41].

Linear [45] and *quadratic* [46] models are proposed to evaluate the rate as a function of ρ , the proportion of null coefficients of a quantized block in the transform domain. To be used, these models require the dependence of ρ with the value of the encoding parameters, as shown in [16].

Inspired from [47], [48] proposed the following model for H.264/AVC at the Macroblock (MB) level

$$R(Q_{\text{step}}) = \left(\frac{a_1}{Q_{\text{step}}} + \frac{a_2}{Q_{\text{step}}^2} + a_3 \right) (a_4 M + a_5) \quad (1)$$

$$D(Q_{\text{step}}) = a_6 Q_{\text{step}} \quad (2)$$

where $\mathbf{a} = (a_1 \dots a_6)$ is the vector of parameters, Q_{step} indicates the quantization step obtained from the QP Q as $Q_{\text{step}} = 2^{(Q-4)/6}$ and S is the Mean Absolute Difference (MAD) of the collocated MB in the previous frame. This model requires a large number of encoding trials to be accurately tuned.

In [21] and [49], the following models have been proposed

$$P(Q) = a_P Q + b_P, \quad (3)$$

$$R(Q) = a_R \exp(-b_R Q), \quad (4)$$

for the PSNR (in dB) and the rate as a function of the QP Q . This model provides a good fit at a GoP level as illustrated in [49], and its parameters (a_P, b_P, a_R, b_R) may be updated recursively.

Due to its moderate complexity, the model (4) and (3) has been considered in what follows.

IV. FORMULATION OF THE JOINT CONTROL AS AN OPTIMIZATION PROBLEM

As introduced in Section II, the aim of the proposed SM system is at each time instant j to provide quantization parameters Q_{ij} to the video encoders and transmission rate R_{ij}^t to the buffers for all programs, while satisfying some QoS constraints. Due to variations of the RD characteristics of video contents,

some short-term decisions taken at time j , considering only the state of the system at time j , may lead to violations of the constraints at some time instant $j' > j$.

The solution proposed for this problem is to perform the control of the video coders over a time window of W VUs for each program, from VU $j - 1$ to VU $j + W - 2$, see Figure 2. At time j and for each program i , the encoder controller evaluates a vector $\mathbf{Q}_i^{(j)} = (Q_{ij}^{(j)} \dots Q_{ij+W-2}^{(j)})$. Only the parameter $Q_{ij}^{(j)}$ evaluated for VU j is applied at time j , the parameters $Q_{ij+k}^{(j)}$ evaluated for future VUs, $k = 1 \dots W - 2$, are not applied but updated at the next time steps. This foresighted control allows choosing a value for the control parameters $\mathbf{Q}_i^{(j)}$ that satisfies the constraints at time j and for which one knows that there exists values $Q_{ij+k}^{(j)}$ such that the constraints are also satisfied at the future time instants considered in the control window.

No predictive control is performed for the buffers, but their level is fed back to the video encoder controller, see Figure 1.

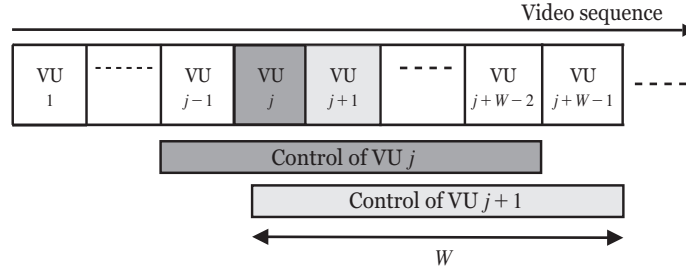

Figure 2. Predictive control involving W VUs

In the following sections, the joint encoder and buffer control problem is formulated as a constrained optimization problem.

A. Cost function

The aim of the proposed SM systems is to maximize the average quality of the broadcasted video programs. The considered cost function

$$\left(\widehat{\mathbf{Q}}_1^{(j)} \dots \widehat{\mathbf{Q}}_N^{(j)} \right) = \arg \max_{\mathbf{Q}_1^{(j)} \dots \mathbf{Q}_N^{(j)}} \sum_{k=j}^{j+W-2} \gamma^{k-j} \sum_{i=1}^N P_{ik} \left(Q_{ik}^{(j)} \right) \quad (5)$$

allows performing the maximization of a discounted sum of PSNRs over the control window of W VUs. The discount factor $0 < \gamma \leq 1$ provides more weight to the PSNR of current VUs for which the channel

conditions and the buffer levels are well known, contrary to future PSNRs for which they are less precisely determined.

B. Rate constraints

Several rate constraints have to be satisfied, as introduced in Section II. To be stated, they require the introduction of a channel model.

1) *Channel model*: In the considered scenario, the bandwidth (and rate) allocated to the broadcast channel may vary with time, as in [50]. These variations may be due to concurrent services, which may leave more or less resources to the broadcast service and are readily considered via the Orthogonal Frequency Division Multiple Access (OFDMA) technique proposed, *e.g.*, in the Long Term Evolution (LTE) standard [51].

The state of the broadcast channel is assumed to vary slowly with time and to be represented by a first-order Markov sequence $\{S_j\}$ [52], [53] with values between 1 and n corresponding to n channel rates $R^1 \dots R^n$. $S_j = k$ means that the channel rate between time j and $j + 1$ is R^k . The state transition probabilities $p_{h,k} = p(S_j = h | S_{j-1} = k)$, as well as the rates are assumed known *a priori*, they may also be estimated on-line. When performing the control at time j , the realization of S_j is also assumed to be known.

2) *Encoder rate constraints*: In average, the sum of the encoding rates should be equal to the channel rate. Thanks to the buffers, some rate variations may be tolerated. In the proposed scheme, at time j , a dynamically updated encoder rate constraint R_j is provided by the buffer controller to the encoder controller, leading to

$$\sum_{i=1}^N R_{ij}^e(Q_{ij}^{(j)}) = R_j. \quad (6)$$

Since it is rather difficult to accurately anticipate the future buffer levels, the encoder rate constraints for VUs between time $j + 1$ and $j + W - 2$ are taken as the expected value of the channel rate, knowing the current channel state S_j . Thus, the following constraints are introduced when performing the predictive control at time j

$$\sum_{i=1}^N R_{ij+k}^e(Q_{ij+k}^{(j)}) = E(R_{j+k}^c | S_j) \quad (7)$$

for $k = 1 \dots W - 2$, with $R_j^c = R^{S_j}$. Satisfying (7) requires at time j the availability of the RD characteristics of VUs at time $j + k$, $k = 1 \dots W - 2$. This introduces a constant additional transmission delay $(W - 2)T$ due to the buffering of $W - 2$ future VUs.

3) *Transmission rate and delay constraints:* For each buffer, the transmission rates R_{ij}^t at time j are chosen to fully use the channel rate and provide an equal buffering *delay* to the N programs. The latter constraint leads to an average switching delay between programs (at least for what concerns the time to get a new INTRA-coded frame) independent of the target program¹, and to control the delivery delay.

At time j , the transmission rates R_{ij}^t have thus to be such that

$$\sum_{i=1}^N R_{ij}^t = R_j^c \quad (8)$$

and having equal delays among programs leads to

$$\tau_{ij+1} = \tau_{i'j+1}, \quad i, i' = 1 \dots N. \quad (9)$$

The delay τ_{ij+1} in buffer i at time $j + 1$ is difficult to determine accurately, since the buffers are drained bit-by-bit. Assuming that at time j , the bits of the encoded VU are regularly fed to the buffer with a rate R_j^e , and that it is regularly drained with rate R_{ij}^t , the buffer level in bits B_{ij+1} at time $j + 1$ is

$$B_{ij+1} = B_{ij} + (R_j^e - R_{ij}^t)T. \quad (10)$$

One gets the following estimate of τ_{ij+1}

$$\tau_{ij+1} = \frac{B_{ij+1}}{\bar{R}_{ij}^e} \quad (11)$$

where \bar{R}_{ij}^e is an estimate of the average rate at which the VUs in the buffer have been encoded. It may be evaluated iteratively using a moving average as follows

$$\begin{aligned} \bar{R}_{i1}^e &= R_{i1}^e \\ \bar{R}_{ij}^e &= \alpha R_{ij}^e + (1 - \alpha) \bar{R}_{ij-1}^e, \end{aligned} \quad (12)$$

where $\alpha < 1$ is some forgetting factor.

Combining (8), (9), (10), and (11), one obtains

$$R_{ij}^t = R_j^c + \frac{B_{ij}}{T} + \frac{\bar{R}_{ij}^e}{\sum_{k=1}^N \bar{R}_{kj}^e} \left(R_j^c - \sum_{k=1}^N R_{kj}^e - \frac{1}{T} \sum_{k=1}^N B_{kj} \right). \quad (13)$$

for $i = 1 \dots N$.

¹MBMS service requires less than 1 second delay when switching between two video programs [54].

With (13), one gets similar delays among programs. These delays are not strictly equal due to the approximations of the average encoding rate considered in (12). This average delay has to remain close to some reference delay τ_0 , which is chosen not too large to limit the global delivery delay, but not too small to mitigate the variations with time of the RD characteristics of video programs and of the channel rate.

At time j , the average delay deviation $\Delta\tau_j$ of each buffering delay τ_{ij} from τ_0 is

$$\Delta\tau_j = \frac{1}{N} \sum_{i=1}^N (\tau_{ij} - \tau_0). \quad (14)$$

When $\Delta\tau_j > 0$, the buffering delays are in average higher than the reference level τ_0 and the encoding rate of the next VUs should be reduced. When $\Delta\tau_j < 0$, the buffers are draining too fast and the encoding rate may be temporarily increased. We propose here to evaluate an updated encoding rate constraint R_j at the buffer controller using a Proportional Integral Derivative (PID) control [55]

$$R_j = R_j^c (1 - K_p \Delta\tau_j - K_i \sum_{k=1}^j \Delta\tau_k - K_d (\Delta\tau_j - \Delta\tau_{j-1})), \quad (15)$$

and to feed it back to the encoder controller. In (15), K_p is the Proportional (P) gain, K_i the Integral (I) gain, and K_d is the Derivative (D) gain. It is well known that P control cannot eliminate steady-state error. Usually, the steady-state error decreases when K_p increases. However, a large K_p may lead to instability. The contribution from the I term is proportional to accumulated errors, and aims at canceling the steady-state error. The D term is used to reduce the magnitude of the overshoot produced by the I term and to improve the closed-loop stability. Various methods have been proposed to tune the PID parameters, see, *e.g.*, [56].

The control in (15), allows a regulation of the incoming flow by updating the encoding rate constraint. Such a regulation is similar to that used in the back-pressure mechanism [57]. We assume that the feedback signal ($\Delta\tau_j$ or R_j) is available instantaneously at the encoder controller and used to select the appropriate QPs for the next VUs.

C. Minimum PSNR constraint

To keep an acceptable visual quality, the PSNR within a VU has to be larger than P_{\min} , the minimum tolerated PSNR. This leads to the constraints

$$P_{ij+k}(Q_{ij+k}^{(j)}) \geq P_{\min}, \quad i = 1 \dots N, \quad k = 0 \dots W - 2 \quad (16)$$

where P_{ij+k} is the PSNR of the i -th program at the $(j+k)$ -th VU. Since the future $W-2$ VUs required to formulate the constraints for $k > 0$ have already been stored to satisfy the constraint presented in (7), no additional delay is introduced.

D. Smoothness constraint

Large PSNR variations between VUs may be visually annoying. The problem of providing video sequences with smooth quality variations has already been addressed in a single video encoding context in [25], [26], and in a SM context by [8], [10]. Here, our aim is to provide some smoothness between successive VUs, considered as GoPs. To obtain smoothness within a GoP, we refer to the works of [25], [26].

Our aim is to bound PSNR variations between successive VUs. This constraint may be relaxed in presence of scene changes, according to the results in [58]: in case of high video activity, the bitrate (and thus the quality) may be reduced to save some bitrate for parts of the video with less activity. We assume that VUs in which a scene change occurs have been detected using the methods presented, *e.g.*, in [59], [60].

At time j , the absolute value of the PSNR difference between two consecutive VUs is constrained to be less than the PSNR variation bound ΔP_{ij}^s . This bound is updated when scene changes occur as follows

$$\Delta P_{ij}^s = \sum_{k=-\infty}^{+\infty} S_{ij-k}^c h_k^s + \Delta P_{min}^s \quad (17)$$

with

$$\begin{aligned} h_k^s &= (\Delta P_{max}^s - \Delta P_{min}^s) \exp(-\lambda k) \text{ if } j \geq 0 \\ h_k^s &= 0 \text{ else} \end{aligned} \quad (18)$$

with $S_{ij}^c = 1$ if a scene change is detected in VU at time j and $S_{ij}^c = 0$ else. ΔP_{max}^s and ΔP_{min}^s are respectively the maximum and the minimum PSNR variation bounds and λ is some decay rate.

Predictive control at time j takes into account the PSNR of one past (at time $j-1$), the current, and $W-2$ future VUs. The smoothness constraint for the i -th program translates into

$$|P_{ij}(Q_{ij}^{(j)}) - P_{ij-1}(\widehat{Q}_{ij-1}^{(j-1)})| \leq \Delta P_{ij}^s, \quad (19)$$

between time $j - 1$, at which the control output $\widehat{Q}_{ij-1}^{(j-1)}$ has already been applied, and time j . Moreover, for $k = 1 \dots W - 2$, the smoothness constraint becomes

$$|P_{ij+k}(Q_{ij+k}^{(j)}) - P_{ij+k-1}(Q_{ij+k-1}^{(j)})| \leq \Delta P_{ij+k}^s, \quad (20)$$

with $i = 1 \dots N$ for the future VUs.

E. Inter-program fairness constraint

Our aim is to provide multiplexed programs with quality levels of the same order of magnitude. For that purpose, the absolute value of the PSNR difference between two programs i and i' is constrained to be less than some PSNR discrepancy bound $\Delta P_{(i,i')j}^f$. These bounds are such that $\Delta P_{(i,i')j}^f = \Delta P_{(i',i)j}^f$ for all $i, i' \in \{1 \dots N\}$. Since at scene changes, the smoothness constraint is relaxed, it is necessary to update $\Delta P_{(i,i')j}^f$ accordingly

$$\Delta P_{(i,i')j}^f = \sum_{k=-\infty}^{+\infty} \max(S_{ij-k}^c, S_{i'j-k}^c) h_k + \Delta P_{\min}^f \quad (21)$$

with

$$\begin{aligned} h_k^f &= (\Delta P_{\max}^f - \Delta P_{\min}^f) \exp(-\lambda k) \text{ if } j \geq 0 \\ h_k^f &= 0 \text{ else} \end{aligned} \quad (22)$$

where ΔP_{\max}^f and ΔP_{\min}^f are respectively the maximum and the minimum PSNR discrepancy bounds. Then, the fairness constraint at time j translates into $N(N - 1)/2$ inequality constraints

$$|P_{ij+k}(Q_{ij+k}^{(j)}) - P_{i'j+k}(Q_{i'j+k}^{(j)})| \leq \Delta P_{(i,i')j+k}^f, \quad (23)$$

with $k = 0 \dots W - 2$ and $i, i' \in \{1 \dots N\}$.

F. Summarized constrained optimization problem

Considering the cost function (5) and the constraints related to the rate (6) and (7), the minimum PSNR (16), the smoothness (19) and (20), and the fairness (23), one gets the following constrained optimization problem to solve at time j

$$\left(\widehat{Q}_1^{(j)} \dots \widehat{Q}_N^{(j)}\right) = \arg \max_{\mathbf{Q}_1^{(j)} \dots \mathbf{Q}_N^{(j)}} \sum_{k=j}^{j+W-2} \gamma^{k-j} \sum_{i=1}^N P_{ik} \left(Q_{ik}^{(j)}\right) \quad (24)$$

subject to

$$\left\{ \begin{array}{l} \sum_{i=1}^N R_{ij}^e(Q_{ij}^{(j)}) = R_j \\ \sum_{i=1}^N R_{ij+k}^e(Q_{ij+k}^{(j)}) = E(R_j^e | S_j) \\ P_{ij+h}(Q_{ij+h}^{(j)}) \geq P_{\min} \\ |P_{ij+h}(Q_{ij+h}^{(j)}) - P_{i'j+h}(Q_{i'j+h}^{(j)})| \leq \Delta P_{(i,i')j+h}^f, \\ |P_{ij}(Q_{ij}^{(j)}) - P_{ij-1}(\widehat{Q}_{ij-1}^{(j-1)})| \leq \Delta P_{ij}^s, \\ |P_{ij+k}(Q_{ij+k}^{(j)}) - P_{ij+k-1}(Q_{ij+k-1}^{(j)})| \leq \Delta P_{ij+k}^s \\ \text{with } h = 0 \dots W - 2, k = 1 \dots W - 2 \\ \text{and } (i, i') \in \{1 \dots N\} \end{array} \right. \quad (25)$$

where \widehat{Q}_{j-1}^{j-1} contains the QP obtained from step $j - 1$ for VU $j - 1$.

The control of the transmission rate and buffering delay is described in Section (IV-B3).

G. Implementation of the proposed SM in a MBMS system

A typical scenario for statistical multiplexing application is the Mobile TV service delivery over evolved MBMS standard [2]. Here, we briefly describe the functional architecture of the multiplexing functions. Detailed implementation issues are not addressed.

MBMS is a point-to-multipoint interface specification for 3GPP cellular networks, which is designed to provide efficient delivery of broadcast and multicast services. For broadcast transmission, a single frequency network configuration is introduced in 3GPP LTE (Long Term Evolution) specifications which enables a time-synchronization between a set of eNBs (base stations) using the same resource block.

MBMS architecture is composed of three main entities: BM-SC, MBMS-GW and MCE. The Multicast/Broadcast Service Center (BM-SC) is a node that serves as an entry point for the content providers delivering the video sources, used for service announcements, session management.

The MBMS-GW is an entity responsible for distributing the traffic across the different eNBs belonging to the same broadcast area. It ensures that the same content is sent from all the eNBs by using IP Multicast.

The Multi-cell/multicast Coordination Entity (MCE) is a new logical entity, responsible for allocation of time and frequency resources for multi-cell MBMS transmission. As in [15], we assume that the MBMS-GW periodically notifies the MCE about the resource requirements of video streams so that the resources at eNBs can be re-allocated accordingly. Therefore, the BM-SC should ensure that the encoding rate of

the multiplex does not violate the already allocated resources. This is obtained thanks to the proposed SM scheme.

V. EXPERIMENTAL RESULTS

In this section, we evaluate the performance of the proposed joint encoder and buffer controller involving the solution of the constrained optimization problem (24) and (25). $N = 4$ programs are multiplexed and transmitted. Each program displays various video sequences in CIF format (Soccer (V1), Container (V2), Coastguard (V3), and Hall (V4)) to simulate abrupt scene changes in the video program as represented in Figure 3. The video sequences are encoded with the H.264/AVC encoder in baseline profile and at the same frame rate $F = 30$ frames/s.

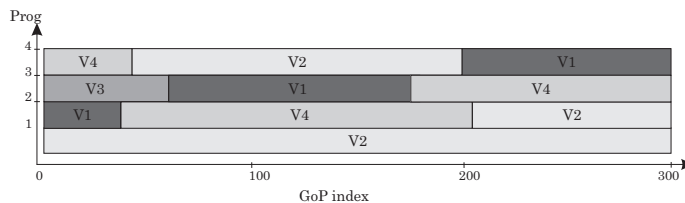

Figure 3. Videos transmitted over the four considered programs

All video programs are divided into GoPs of $N_f = 15$ frames, thus the VU (GoP) duration is $T = 0.5$ s. The first frame in the GoP is an I frame and the remaining frames are P frames. More sophisticated GoP structures may also be employed.

In the first set of experiments, we focus on the video encoder control process described in (24) and (25). The predictive control is performed using a control window of $W = 4$ GoPs and is compared to a reference scenario without predictive control ($W = 2$), but for which the smoothness constraint is still imposed. The RD models, presented in Section III, have to be evaluated in advance for $W - 1$ GoPs with two encoding trials for each GoP. Using predictive control, an encoding delay $(W - 2)T$ is introduced. When $W = 4$, this delay is 1 s.

Scene changes are assumed known in advance for each program. The minimum tolerated PSNR is $P_{\min} = 30$ dB. The PSNR variation and discrepancy bounds are $\Delta P_{\max}^s = 2.5$ dB, $\Delta P_{\min}^s = 1$ dB, $\Delta P_{\max}^f = 5$ dB, and $\Delta P_{\min}^f = 2$ dB. The damping ratio is $\lambda = 1.25$, leading to a negligible relaxation of the PSNR bounds after 2 to 3 VUs.

The size of the buffers is taken large enough to support the large bit level variations, occurring, *e.g.*,

during scene changes. Here, their size in bits is $B_{\max} = 4$ Mbits. The reference delay is taken as $\tau_0 = 1$ s. Two cases are considered: (i) constant channel rate as in [11] and (ii) time-varying channel rate as in [15].

In what follows, the solutions of (24) and (25) involved in the control process are obtained numerically using Matlab.

A. Constant channel rate

In this section, we consider a constant channel rate taken as $R_j^c = 1$ Mbit/s for all time j . The parameters of the PID controller for the feedback from the buffer controller to the encoder controller are set to $(K_p, K_i, K_d) = (0.2, 0.01, 0.01)$ for $W = 2$ and $(K_p, K_i, K_d) = (0.2, 0.01, 0.05)$ for $W = 4$, see Section V-A2 for more details on the tuning of the PID controller.

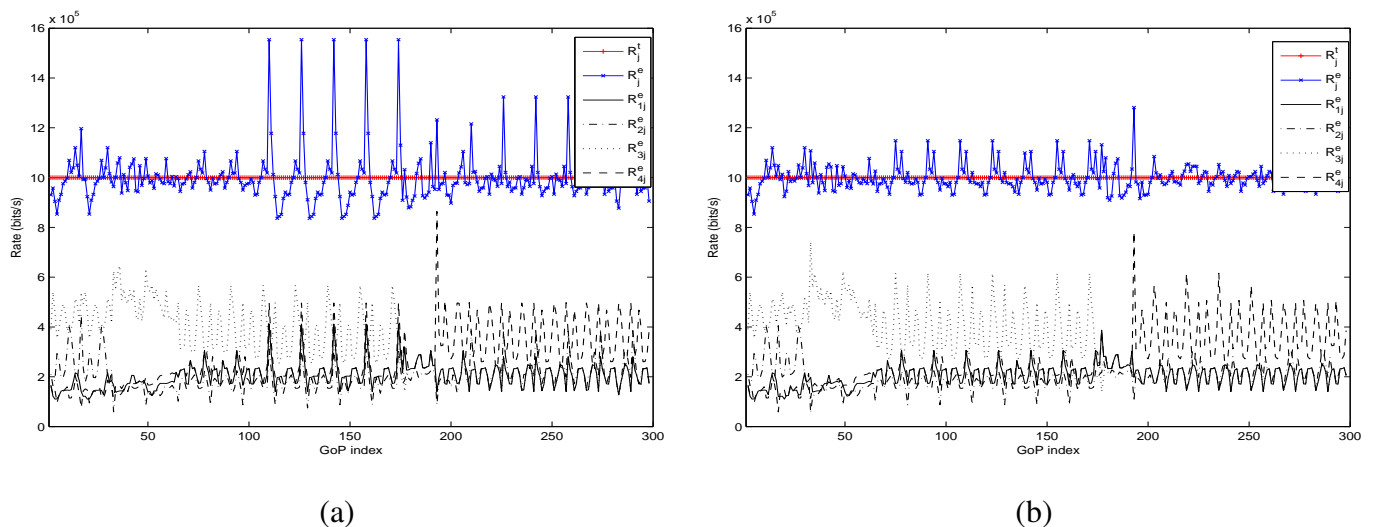

Figure 4. Evolution of the total transmission rates as well as individual and total encoding rates for the four multiplexed programs when $W = 2$ (a) and $W = 4$ (b)

1) *Rate and quality control:* Figure 4 shows the encoding rates R_{ij}^e for each program, the total encoding rate $R_j^e = \sum_{i=1}^4 R_{ij}^e$ and the total transmission rate $R_j^t = \sum_{i=1}^4 R_{ij}^t$ for $W = 2$ (a) and $W = 4$ (b). In both cases, R_j^t is equal to the channel rate R_j^c thanks to the buffer control. The PSNR P_{ij} of each program is represented in Figure 5 for $W = 2$ (a) and $W = 4$ (b). Thanks to the fairness constraint, a similar quality is obtained for all transmitted programs.

The differences between successive PSNRs ($P_{ij} - P_{ij-1}$) for each program are represented in Figure 6 in the following cases: without smoothness constraint, with a smoothness constraint involving only the past VU (case $W = 2$), and with a smoothness constraint involving both past and future VUs ($W = 4$). The smoothness constraints are less frequently violated when $W = 2$ (2.75 % of time) or when $W = 4$

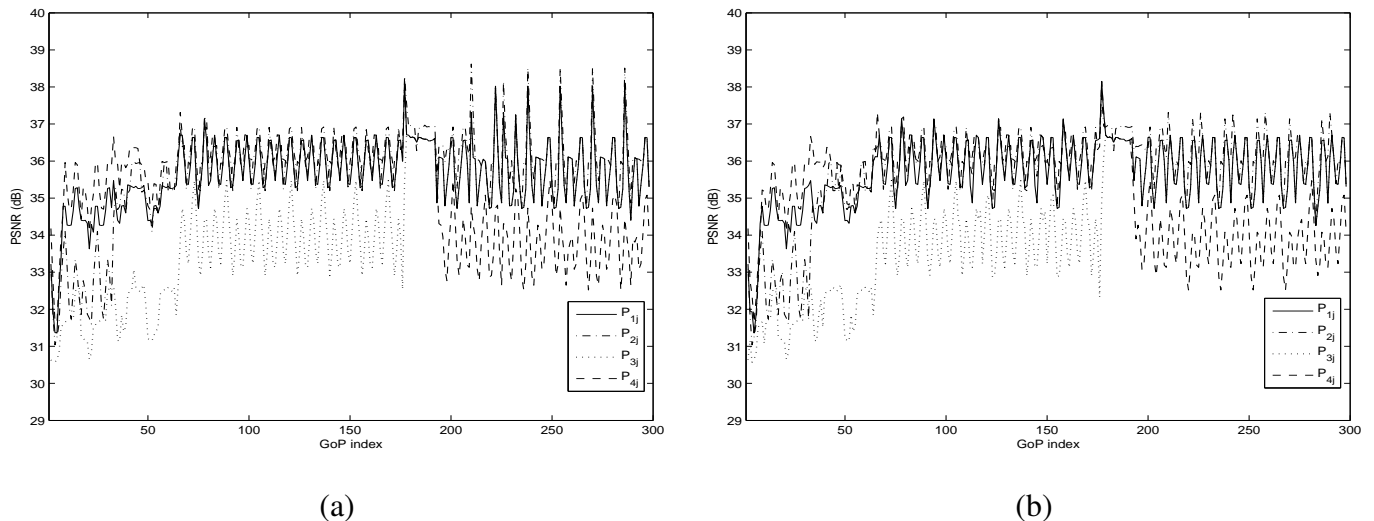

Figure 5. Evolution of the PSNR of the four multiplexed programs when $W = 2$ (a) and $W = 4$ (b)

(1.8 % of time) than without smoothness constraint (4 % of time). Some violations occur even when smoothness is requested due to the discrepancy between the RD models used in the control process and the actual RD characteristics of each video sequence.

Introducing the smoothness constraint reduces the amplitude of PSNR variations, see also Figure 7, where the standard deviation of the PSNR is represented for several values of the channel rate. In the three considered cases, the standard deviation decreases with the increase of the channel rate. Taking $W > 4$ with the same values of ΔP_{ij}^f and ΔP_{ij}^s does not provide any additional benefit in terms of variations of the PSNR.

2) *Performance of the buffer control:* This section illustrates the performance of the buffer management. The transmission rates R_{ij}^t are obtained analytically as shown in Section (IV-B3). The actual buffering delay τ_{ij} for each buffer is represented in Figure 9 for $W = 2$ (a) and $W = 4$ (b).

The parameters of the PID controller have been tuned manually using first a simplified scenario where the 4 multiplexed programs display only the first GoP of each video in a loop. Moreover, buffers have been assumed to be initially empty. This helps to get some steady-state after a transient behavior. The evolution of the buffer delays for different values of the PID parameters and $W = 4$ is presented in Figure 8. K_p is tuned first to maximize the rise speed to some equilibrium while having no overshoot. In Figure 8(a), the choice $K_p = 0.3$ appears to be a good compromise. K_i is adjusted to eliminate the offset and to minimize the overshoot. Figure 8(b) shows that $K_i = 0.01$ provides the best results. Finally K_d should provide some additional stability to the system. In Figure 8(c), $K_d = 0.2$ is a reasonable choice.

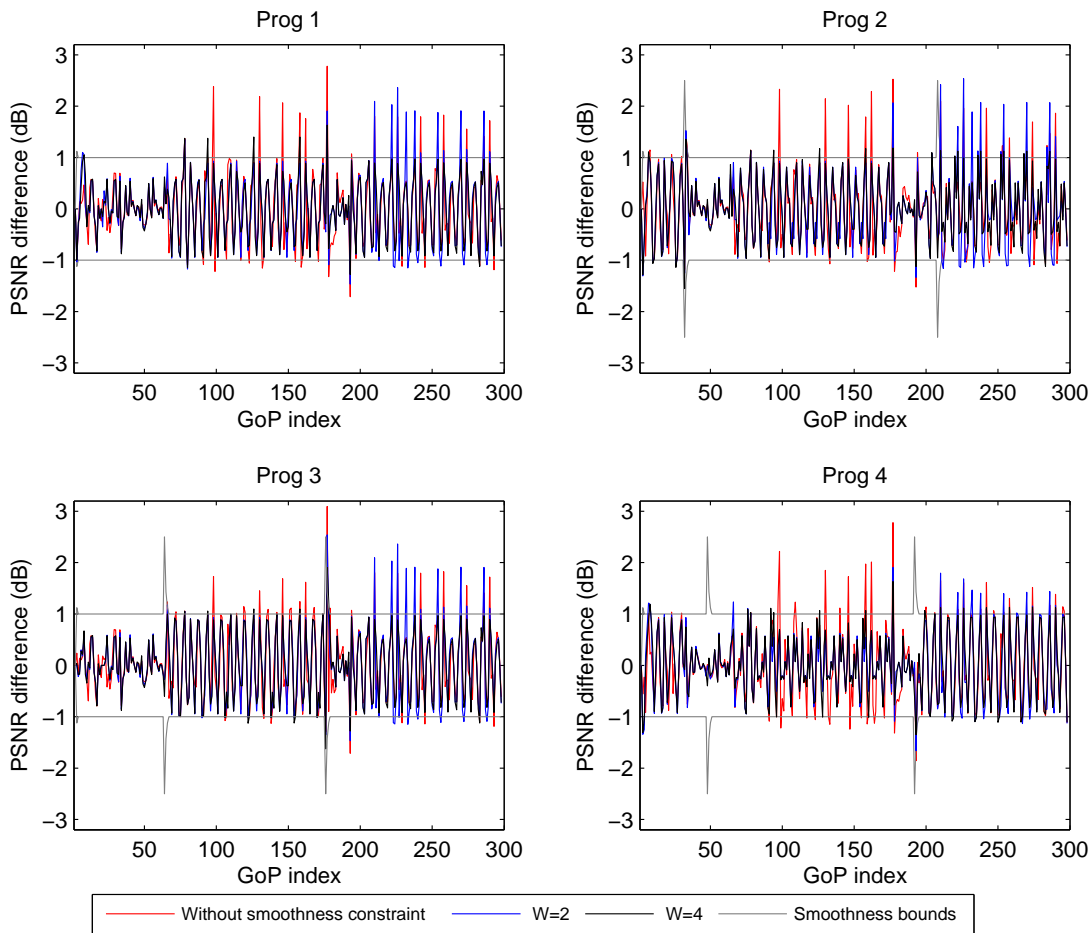

Figure 6. PSNR differences with smoothness constraint, when $W = 2$ and $W = 4$

K_p, K_i, K_d	$W = 2$			K_p, K_i, K_d	$W = 4$		
	$\Delta\tau$	σ_τ^2	e		$\Delta\tau$	σ_τ^2	e
0.2, 0, 0	0.02	0.05	0.05	0.2, 0, 0	0.01	0.013	0.014
0.2, 0.01, 0	0.01	0.04	0.04	0.2, 0.01, 0	0.003	0.016	0.016
0.2, 0.01, 0.01	0.01	0.04	0.04	0.2, 0.01, 0.05	0.003	0.015	0.015

Table III

SYSTEM PERFORMANCE IN TERMS OF $\Delta\tau$ AND σ_τ^2 WHEN USING P, PI, AND PID CONTROLLERS FOR $W = 2$ AND $W = 4$ USING CONSTANT CHANNEL RATE

Figure 8 shows some oscillating behavior after the transient phase. This is due to the discrepancy between the model and the actual RD characteristics and to the fact that the QPs provided by the optimization process have to be rounded before being used by the video encoders. This type of oscillatory behavior due to quantized inputs has been considered in [61] and [62].

The parameters K_p , K_i , and K_d are then updated to minimize $e = (\Delta\tau)^2 + \sigma_\tau^2$ where $\Delta\tau$ is the average

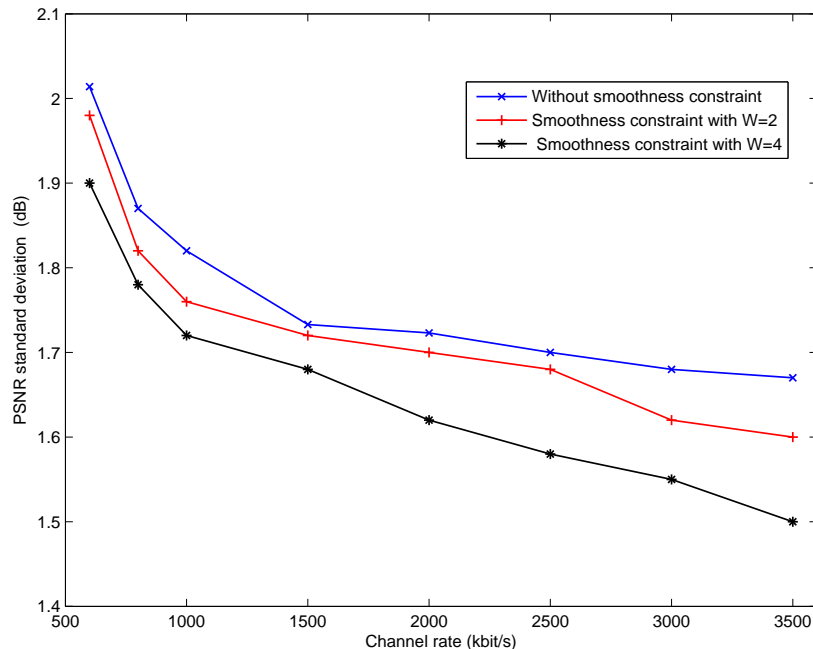

Figure 7. Standard deviation of the PSNR without smoothness constraint, with smoothness constraint when $W = 2$ and $W = 4$ for different channel rates

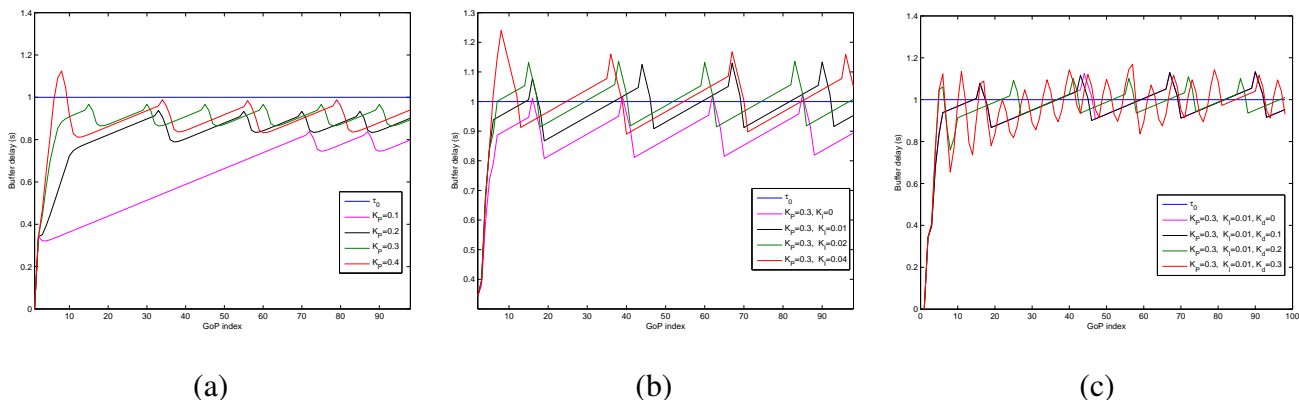

Figure 8. Tuning of the parameters of the PID controller

delay discrepancy and σ_τ^2 is the average delay variance considering the actual programs. Table III provides the system performance in terms of $\Delta\tau$ and σ_τ^2 when using P, PI, and PID controllers. From Figure 9 and Table III, one sees that PI control reduces significantly $\Delta\tau$. The derivative term reduces σ_τ^2 .

For $W = 4$, one sees that the variation of the buffering delay is smoother than for $W = 2$. This is due to the foresighted encoding rate adaptation performed to better satisfy the quality constraints. The forgetting factor is set to $\alpha = 0.7$ corresponding to the smallest average relative discrepancy (less than 2%) between the estimated delay using (11) and the actual buffer delay represented in Figure 9. The closed-loop control allows the buffering delays to be of the same order of magnitude for the four multiplexed programs, even

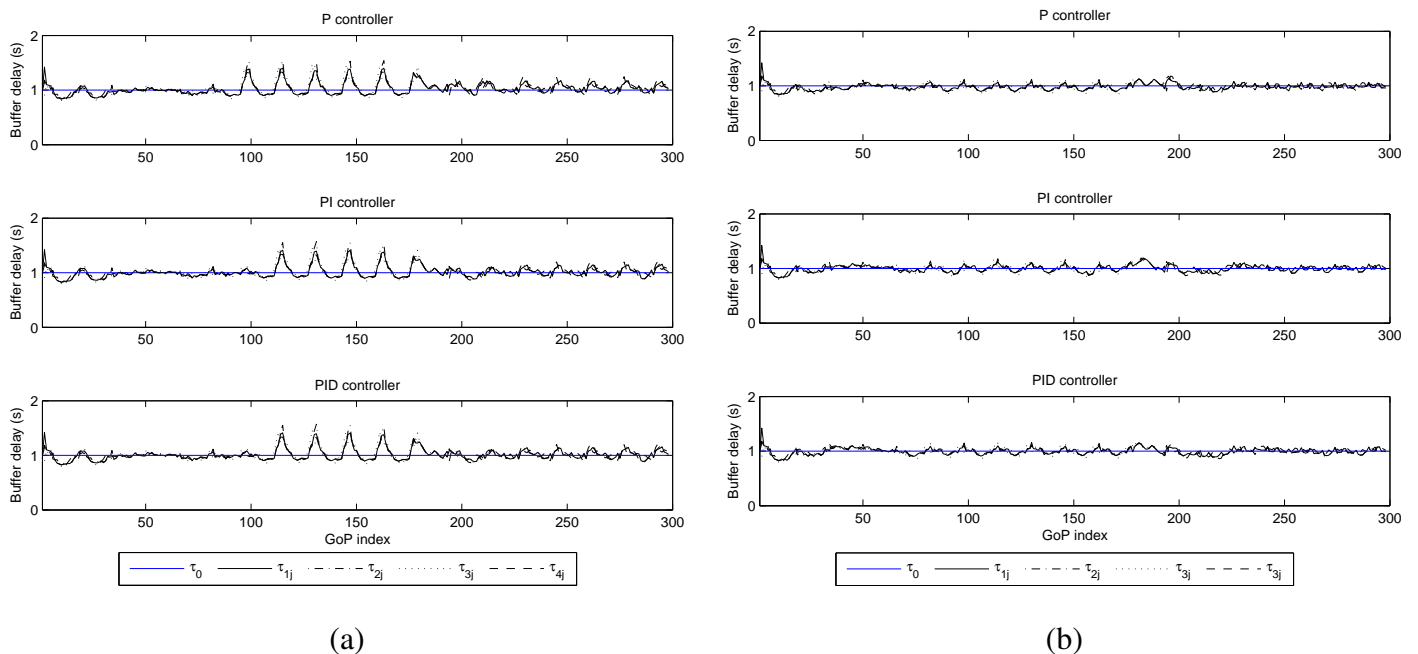

Figure 9. Buffering delay evolution of the 4 multiplexed programs using P, PI, and PID controller with $W = 2$ (a) and $W = 4$ (b) in the encoder control process with constant channel rate

with different contents and characteristics.

In addition, although the constrained problem in (8) does not involve the reference delay τ_0 , thanks to the PID feedback, the buffering delay in the four considered buffers remains around τ_0 .

B. Variable channel rate

This section considers a variable broadcast channel rate. The rate variations are modeled as a three-state Markov chain, each state representing a rate belonging to $\mathcal{R}^c = \{800, 1000, 1200\}$ kbits/s. The channel state transition probabilities are given in the following transition matrix

$$P = \begin{bmatrix} 0.95 & 0.05 & 0 \\ 0.025 & 0.95 & 0.025 \\ 0 & 0.05 & 0.95 \end{bmatrix}. \quad (26)$$

Notice that even when performing a predictive control, only the channel rate at time j is assumed to be known and expected rates at future time instants are evaluated, see (7).

1) *Rate and quality control*: Figure 10 shows the encoding rates R_{ij}^e for each program, the total encoding rate $R_j^e = \sum_{i=1}^4 R_{ij}^e$, and the total transmission rate $R_j^t = \sum_{i=1}^4 R_{ij}^t$ for $W = 2$ (a) and $W = 4$ (b). In both cases $W = 2$ and $W = 4$, the encoding rate is updated to allow an efficient use of the available channel rate. The same values for the PID parameters as in Section V-A2 have been used.

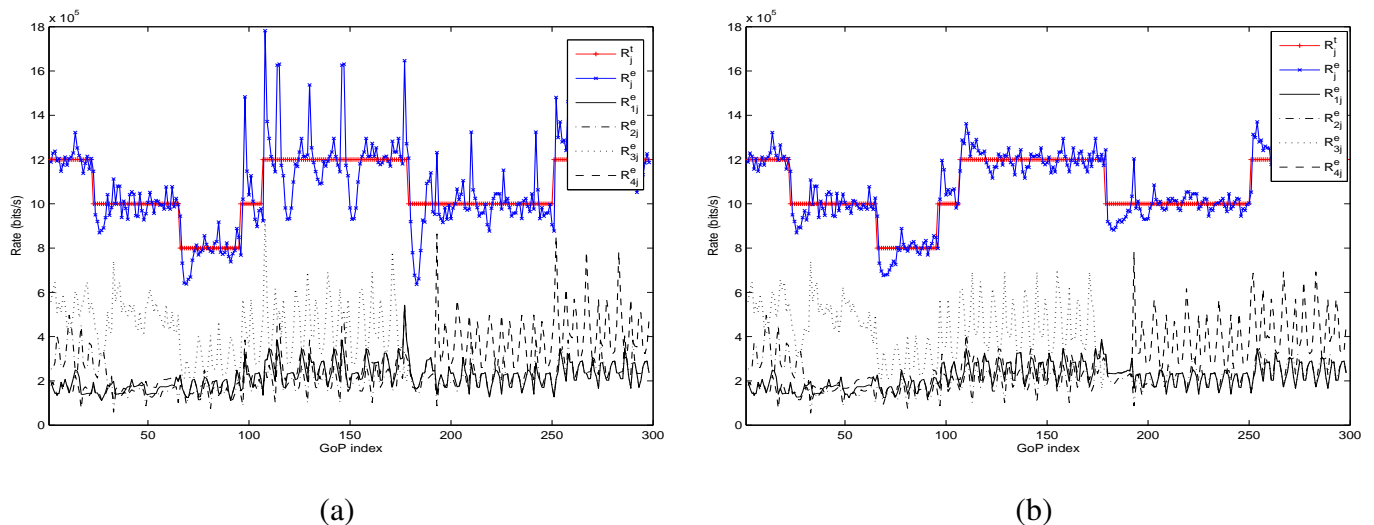

Figure 10. Evolution of the total transmission rates as well as individual and total encoding rates for the four multiplexed programs when $W = 2$ (a) and $W = 4$ (b) with variable channel rate

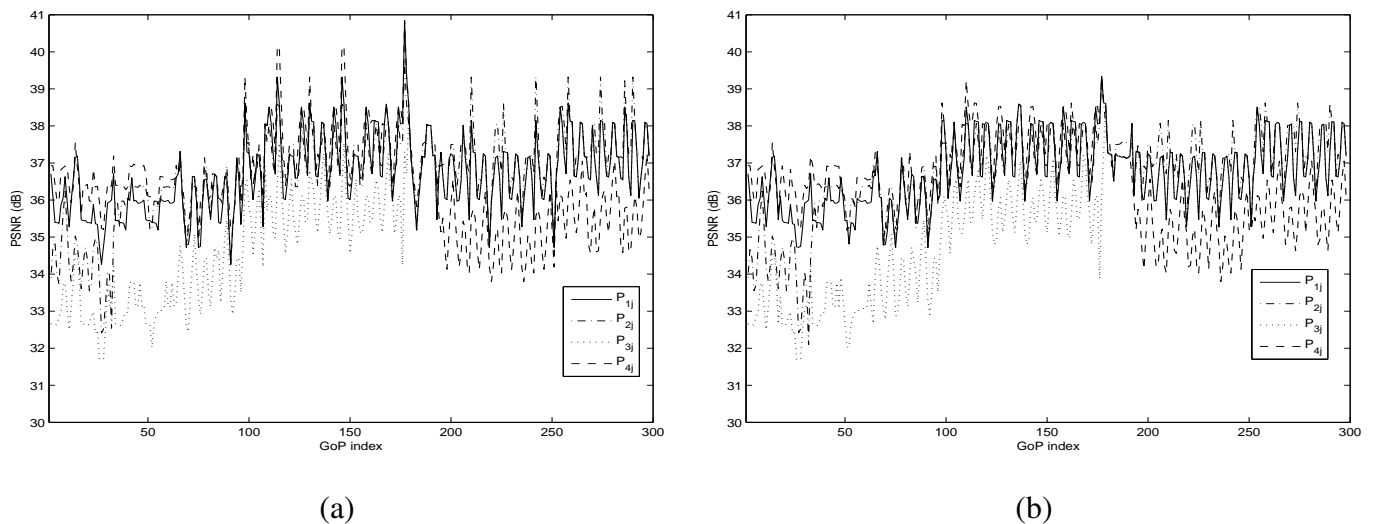

Figure 11. Evolution of the PSNR of the four multiplexed programs when $W = 2$ (a) and $W = 4$ (b) with variable channel rate

The total transmission rate equals the channel rate. When the channel rate varies, the system is able to adapt the encoding parameters so that the total encoding rate satisfy the updated rate constraint and the smoothness and fairness constraints are satisfied. One can see that our proposed control system is robust to variations of the characteristics of the video contents and of the channel rate.

The PSNR variations resulting from the encoder control process are represented in Figure 11 for the four multiplexed programs for $W = 2$ (a) and $W = 4$ (b). Similarly to the constant channel rate case, the predictive control allows reducing the PSNR standard deviation from 2.15 dB without predictive control to 1.8 dB.

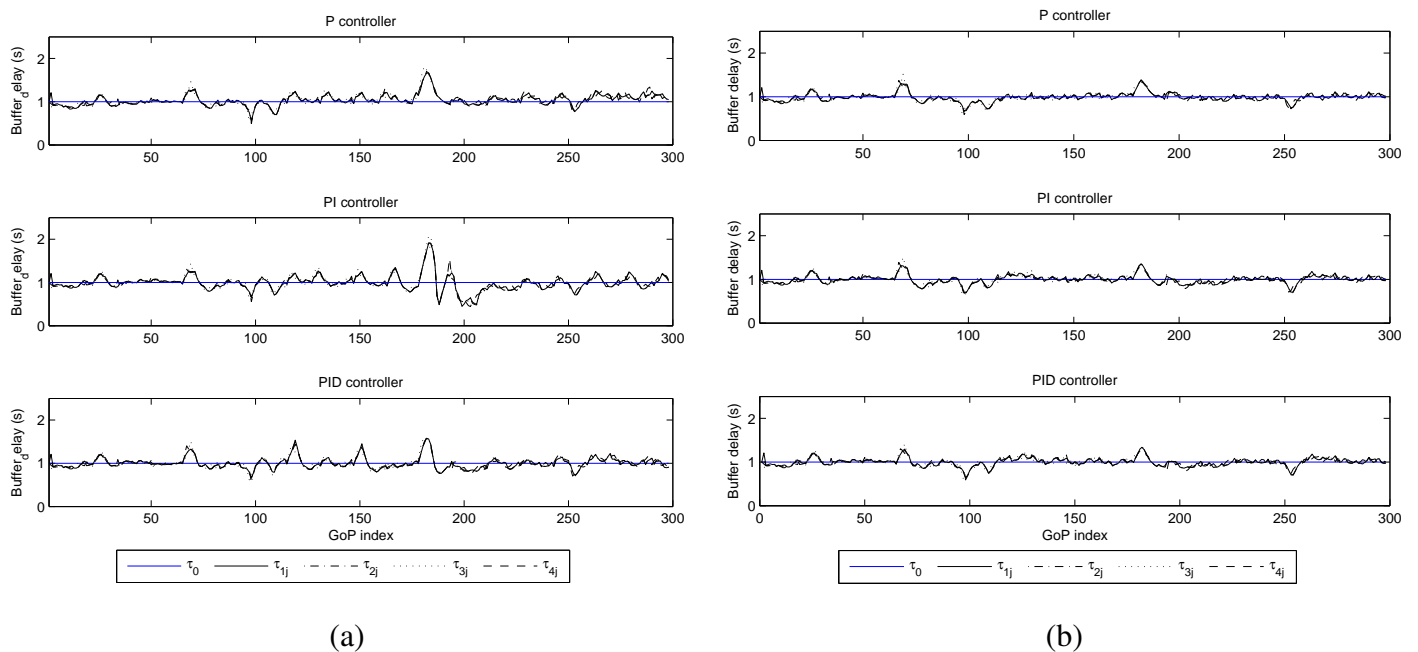

Figure 12. Buffering delay evolution of the four multiplexed programs using P, PI, and PID controller with $W = 2$ (a) and $W = 4$ (b) in the encoder control process with variable channel rate

K_p, K_i, K_d	$W = 2$			K_p, K_i, K_d	$W = 4$		
	$\Delta\tau$	σ_τ^2	e		$\Delta\tau$	σ_τ^2	e
0.2, 0, 0	0.03	0.08	0.08	0.2, 0, 0	0.01	0.03	0.03
0.2, 0.01, 0	0.001	0.13	0.13	0.2, 0.01, 0	0.001	0.04	0.04
0.2, 0.01, 0.01	0.001	0.06	0.06	0.2, 0.01, 0.05	0.001	0.03	0.03

Table IV

SYSTEM PERFORMANCE IN TERMS OF $\Delta\tau$ AND σ_τ^2 WHEN USING P, PI, AND PID CONTROLLERS FOR $W = 2$ AND $W = 4$ USING VARIABLE CHANNEL RATE

The performance in terms of $\Delta\tau$, σ_τ^2 , and e for the buffer control are provided in Table IV, showing a good robustness of the PID parameters with respect to variations of the channel rate. The buffering delays in each buffer are represented in Figure 12 for $W = 2$ (a) and $W = 4$ (b) using P, PI, and PID controllers. Channel variations lead in this case to less differences between the P, PI, and PID controllers when $W = 2$ and $W = 4$ than in the constant channel rate case.

VI. CONCLUSIONS

A predictive controller for a SM system using H.264/AVC video encoders has been presented in the context of video broadcasting. The proposed system performs a closed-loop regulation of the encoders and the buffers using a PID feedback. Control accounts for the channel rate variations by distributing the

available channel rate among the encoders while satisfying minimum quality, smoothness, and fairness constraints. A similar and small buffering delay for all multiplexed programs is also targeted.

The performance of the proposed system has been evaluated via simulations at GoP level and compared with a reference control scheme where only regulation with respect to the past GoP is performed. Experimental results with constant and variable channel rate show that thanks to the predictive and to the closed-loop control of the encoders and of the buffers, the channel is efficiently used, the video quality constraints are satisfied as well as the constraints on the buffering delays. Moreover, predictive control decreases the intra-program quality variations compared to the non predictive control.

The adaptation of the proposed SM at the frame level, as in [17], will be addressed in future work. A closed-loop rate and buffer control at the frame level requires dependent RD models, such as those described in [24], [63], or [44]. Such models $R_{ij}(Q_{ij}, Q_{ij-1})$ and $D_{ij}(Q_{ij}, Q_{ij-1})$ take into account the impact of the chosen QP in the reference frame on the rate and the distortion of its corresponding predicted frame. The price to be paid is a much increased modeling complexity than with a GoP-level control.

REFERENCES

- [1] ETSI, "Digital video broadcasting (DVB); DVB-SH implementation guidelines," ETSI TS, Standard, Dec 2008.
- [2] ETSI, "Multimedia Broadcast/Multicast service. (MBMS); UTRAN/GERAN requirements," 3GPP TR 25.992-140, Tech. Rep., jun. 2005.
- [3] R. Koenen, "MPEG-4 overview," ISO/IEC JTC1/SC29/WG11, Tech. Rep., March 2002.
- [4] T. Wiegand, G. Sullivan, G. Bjontegaard, and A. Luthra, "Overview of the H.264/AVC video coding standard," *IEEE Trans. on Circuits and Systems for Video Technology*, vol. 13, no. 7, pp. 560–576, July 2003.
- [5] H. Schwarz, D. Marpe, and T. Wiegand, "Overview of the scalable video coding extension of the H.264/AVC standard," *IEEE Trans. on Circuits and Systems for Video Technology In Circuits and Systems for Video Technology*, vol. 17, no. 9, pp. 1103–1120, September 2007.
- [6] Q. Chengsheng, C. Guobin, and L. Jilin, "An efficient two-pass VBR encoding algorithm for H.264," in *Int. Conference on Communications Circuits and Systems Proc.*, vol. 1, June 2006, pp. 118–122.
- [7] K. Chandra, *The Wiley Encyclopedia of Telecommunications*. Wiley, 2002, ch. Statistical Multiplexing.
- [8] G. Valenzise, M. Tagliasacchi, and S. Tubaro, "A smoothed, minimum distortion-variance rate control algorithm for multiplexed transcoded video sequences," in *Proc. Int. Workshop on Mobile Video*. New York, NY, USA: ACM, 2007, pp. 55–60.
- [9] M. Jacobs, J. Barbarien, S. Tondeur, R. Van de Walle, T. Paridaens, and P. Schelkens, "Statistical multiplexing using SVC," in *IEEE International Symposium on Broadband Multimedia Systems and Broadcasting*, march 2008, pp. 1–6.
- [10] M. Tagliasacchi, G. Valenzise, and S. Tubaro, "Minimum variance optimal rate allocation for multiplexed H.264/AVC bitstreams," *IEEE Trans. on Image Processing*, vol. 17, no. 7, pp. 1129–1143, July 2008.
- [11] M. Rezaei, I. Bouazizi, and M. Gabbouj, "Implementing statistical multiplexing in DVB-H," *International Journal of Digital Multimedia Broadcasting*, p. 15, April 2009, article ID 261231.

- [12] X. Wang and Y. Zhang, "Optimal video stream multiplexing in MBSFN," in *IEEE International Conference on Communications Technology and Applications*, oct. 2009, pp. 360–365.
- [13] A. Elwalid and D. Mitra, "Statistical multiplexing with loss priorities in rate-based congestion control of high-speed networks," *IEEE Trans. on Communications*, vol. 42, no. 11, pp. 2989–3002, nov 1994.
- [14] L. Wang and A. Vincent, "Joint rate control for multi-program video coding," *IEEE Trans. on Consumer Electronics*, vol. 42, no. 3, pp. 300–305, Aug 1996.
- [15] V. Vukadinovic and J. Huschke, "Statistical multiplexing gains of H.264/AVC video in E-MBMS," in *International Symposium on Wireless Pervasive Computing*, May 2008, pp. 468–474.
- [16] M. Rezaei, I. Bouazizi, and M. Gabbouj, "Joint video coding and statistical multiplexing for broadcasting over DVB-H channels," *IEEE Transactions on Multimedia*, vol. 10, no. 8, pp. 1455–1464, dec. 2008.
- [17] Z. He and D. O. Wu, "Linear rate control and optimum statistical multiplexing for H.264 video broadcast," *IEEE Trans. on Multimedia*, vol. 10, no. 7, pp. 1237–1249, November 2008.
- [18] M. Perkins and D. Arnstein, "Statistical multiplexing of multiple MPEG-2 video programs in a single channel," *SMPTE journal*, vol. 104, no. 9, pp. 596–599, 1995.
- [19] Z. Zhang, S. Nelakuditi, R. Aggarwal, and R. Tsang, "Efficient selective frame discard algorithms for stored video delivery across resource constrained networks," *Real-Time Imaging*, vol. 7, no. 3, pp. 255–273, June 2001.
- [20] T.-L. Lin, Y. Zhi, S. Kanumuri, P. Cosman, and A. Reibman, "Perceptual quality based packet dropping for generalized video gop structures," in *IEEE International Conference on Acoustics, Speech and Signal Processing*, ser. ICASSP '09, 2009, pp. 781–784.
- [21] S. Ma, W. Gao, and Y. Lu, "Rate-distortion analysis for H.264/AVC video coding and its application to rate control," *IEEE Trans. on Circuits and Systems for Video Technology*, vol. 15, no. 12, pp. 1533–1544, December 2005.
- [22] S. K. Srinivasan, J. Vahabzadeh-Hagh, and M. Reisslein, "The effects of priority levels and buffering on the statistical multiplexing of single-layer H.264/AVC and SVC encoded video streams," *IEEE Trans. on Broadcasting*, vol. 56, no. 3, pp. 281–287, 2010.
- [23] E. Maani and A. Katsaggelos, "Unequal error protection for robust streaming of scalable video over packet lossy networks," *IEEE Trans. on Circuits and Systems for Video Technology*, vol. 20, no. 3, pp. 407–416, march 2010.
- [24] J. Lin and A. Ortega, "Bit-rate control using piecewise approximated rate-distortion characteristics," *IEEE Trans. on Circuits Syst. Video Technol*, vol. 8, pp. 446–459, 1998.
- [25] L. Luo, J. Xu, S. Li, and Z. Zhuang, "Rate control with smoothed temporal distortion for a 3D embedded wavelet video coder," in *Proc. IEEE Int. Conf. Info., Commu. & Sig. Process*, Singapore, Oct. 2001.
- [26] A. Munteanu, Y. Andreopoulos, M. van der Schaar, P. Schelkens, and J. Cornelis, "Control of the distortion variation in video coding systems based on motion compensated temporal filtering," in *International Conference on Image Processing*, vol. 2, sept. 2003, pp. II–61–4 vol.3.
- [27] X. Kang, J. Lan, L. Liu, and X. Zhuang, "SNR-based bit allocation in video quality smoothing," in *Advances in Multimedia Information Processing - PCM 2006*, ser. Lecture Notes in Computer Science, 2006, vol. 4261, pp. 989–998.
- [28] L. Böröczky, A. Y. Ngai, and E. F. Westermann, "Statistical multiplexing using MPEG-2 video encoders," *IBM Journal of Research and Development*, vol. 43, no. 4, pp. 511–520, 1999.
- [29] J. Zdepski, D. Raychaudhuri, and K. Joseph, "Statistically based buffer control policies for constant rate transmission of compressed digital video," *IEEE Trans. on Communications*, vol. 39, no. 6, pp. 947–957, jun 1991.
- [30] M. Mandjes, D. Mitra, and W. Scheinhardt, "Models of network access using feedback fluid queues," *Queueing Syst. Theory Appl.*, vol. 44, no. 4, pp. 365–398, 2003.

- [31] L. Wing-Cheong and L. San-Qi, "Statistical multiplexing and buffer sharing in multimedia high-speed networks: a frequency-domain perspective," *IEEE/ACM Trans. on Networking*, vol. 5, no. 3, pp. 382–396, Jun 1997.
- [32] N. Changuel, B. Sayadi, and M. Kieffer, "Joint encoder and buffer control for statistical multiplexing of multimedia contents," in *IEEE Global Communications Conference: Globecom*, 2010, pp. 1–6.
- [33] ITU-T, "Objective perceptual multimedia video quality measurement in the presence of a full reference," ITU-T Rec. J.247 (08/08), Tech. Rep. Rec. J.247, 2008.
- [34] G. J. Sullivan and T. Wiegand, "Rate-distortion optimization for video compression," *IEEE Signal Processing Magazine*, vol. 15, no. 6, pp. 74–90, November 1998.
- [35] G. Winkler, *Image Analysis, Random Fields and Dynamic Monte Carlo Methods: A Mathematical Introduction, Second edition*, 2nd ed., S. Verlag, Ed. Springer, 2005, vol. 27 of Applications of Mathematics.
- [36] W. Ding and B. Liu, "Rate control of MPEG video coding and recording by rate-quantization modeling," *IEEE trans. on Circuits and Systems for Video Technology*, vol. 6, no. 1, pp. 12–20, February 1996.
- [37] H. Hang and J. Chen, "Source model for transform video coder and its application I: Fundamental theory," *IEEE Trans. on Circuits and Systems for Video Technology*, vol. 7, no. 2, pp. 287–298, April 1997.
- [38] N. Kamaci, Y. Altunbasak, and R. Mersereau, "Frame bit allocation for the H.264/AVC video coder via Cauchy-density-based rate and distortion models," *IEEE Trans on Circuits and Systems for Video Technology*, vol. 15, no. 8, pp. 994–1006, Aug. 2005.
- [39] H. Shen, X. Sun, F. Wu, and S. Li, "Rate-distortion optimization for fast hierarchical B-picture transcoding," *Proc. IEEE International Symposium on Circuits and Systems*, pp. 5279–5282, 2006.
- [40] X. Zhu, P. Agrawal, J. Pal Singh, T. Alpcan, and B. Girod, "Rate allocation for multi-user video streaming over heterogeneous access networks," in *ACM Multimedia*, Germany, September 2007, pp. 37–46.
- [41] Y. Liu, Z. Li, and Y. Soh, "A novel rate control scheme for low delay video communication of H.264/AVC standard," *IEEE Trans. on Circuits and Systems for Video Technology*, vol. 17, no. 1, pp. 68–78, January 2007.
- [42] N. Changuel, B. Sayadi, and M. Kieffer, "Predictive control for efficient statistical multiplexing of digital video programs," in *Int. Packet Video Workshop*, May 2009, pp. 1–9.
- [43] X. Minghui, A. Vetro, S. Huifang, and L. Bede, "Rate-distortion optimized bit allocation for error resilient video transcoding," in *ISCAS*, vol. 3, May 2004, pp. III-945–8 Vol.3.
- [44] N. Changuel, B. Sayadi, and M. Kieffer, "H.264/AVC inter frame rate distortion dependency analysis based on independent regime switching AR models," in *IEEE International Conference on Acoustics, Speech, and Signal Processing*, Mars 2010.
- [45] Z. He and S. K. Mitra, "A linear source model and a unified rate control algorithm for DCT video coding," *IEEE Transactions on Circuits and Systems for Video Technology*, vol. 12, no. 11, pp. 970–982, November 2002.
- [46] L. Liu and X. Zhuang, "A novel square root rate control algorithm for H.264/AVC encoding," in *IEEE International Conference on Multimedia and Expo*, June 2009, pp. 814–817.
- [47] Z. Li, W. Gao, F. Pan, S. Ma, K. Pang Lim, G. Feng, X. Lin, S. Rahardja, H. Lu, and Y. Lu, "Adaptive basic unit layer rate control for JVT," JVT-H014, Geneva, Tech. Rep., 2003.
- [48] H. Wang and S. Kwong, "A rate-distortion optimization algorithm for rate control in H.264," in *IEEE International Conference on Acoustics, Speech and Signal Processing*, vol. 1, 2007, pp. I-1149–I-1152.
- [49] J. Yang, Q. Dai, W. Xu, and R. Ding, "A rate control algorithm for MPEG-2 to H.264 real-time transcoding," *Visual Communications and Image Processing*, vol. 5960, pp. 1995–2003, 2005.

- [50] C.-H. Chu, H.-P. Hung, and M.-S. Chen, "Variant bandwidth channel allocation in the data broadcasting environment," in *International Conference on Mobile Data Management*, may 2007, pp. 94 –101.
- [51] T. I. Sesia, S. and and M. Baker, *LTE, The UMTS Long Term Evolution: From Theory to Practice*. Wiley, Feb. 2009.
- [52] M. Jolfaei, D. Kreuer, O. Maly, U. Quernheim, and W. Kremer, "Time variant models for satellite channel," in *IEEE Vehicular Technology Conference*, vol. 1, 1992, pp. 143 – 146.
- [53] C. Martin, A. Geurtz, and B. Ottersten, "File based mobile satellite broadcast systems: Error rate computation and QoS based design," in *Proceedings IEEE Vehicular Technology Conference*, 2004, vol. 6, pp. 4017–4021.
- [54] ARIB STD-T63-22.246 V8.5.0, "Multimedia Broadcast/Multicast Service (MBMS) user services stage 1 (release 8)," 3GPP TS, Tech. Rep., 2008.
- [55] K. Ström and T. Hägglund, *Advanced PID Control*. USA: ISA, Research Triangle Park, 2005.
- [56] G. M. Van Der Zalm, *Examination board tuning of PID type controllers: Literature overview*. Eindhoven : Technische Universiteit Eindhoven, 2008.
- [57] K.-B. Kim and H.-J. Kim, "Back-pressure buffering scheme to improve the cell loss property on the output buffered atm switch," in *IEEE Conference on Local Computer Networks*, 1996, pp. 242 –248.
- [58] H.-M. Sun, Y.-C. Lin, and L. Shu, "The impact of varying frame rates and bit rates on perceived quality of low/high motion sequences with smooth/complex texture," *Multimedia Systems*, vol. 14, no. 1, pp. 1–13, 2008.
- [59] W. Fernando and K. Loo, "Abrupt and gradual scene transition detection in MPEG-4 compressed video sequences using texture and macroblock information," in *International Conference on Image Processing*, vol. 3, 2004, pp. 1589–1592.
- [60] J.-W. Kim, S.-M. Byun and C.-S. Won, "A scene change detection in H.264/AVC compression domain," in *Advances in Multimedia Information Processing*, vol. 3768, 2005, pp. 1072–1082.
- [61] A. Picasso, B.; Bicchi, "On the stabilization of linear systems under assigned I/O quantization,," *IEEE Transactions on Automatic Control*, vol. 52, no. 10, pp. 1994–2000, 2007.
- [62] A. H. C. Gosline, V. Hayward, and H. Michalska, "Ineluctability of oscillations in systems with digital implementation of derivative feedback," *Automatica*, p. in press, 2011.
- [63] X. Minghui, A. Vetro, S. Huifang, and L. Bede, "Rate distortion optimized bit allocation for error resilient video transcoding," in *IEEE International Symposium on Circuits and Systems*, vol. 5, 2004, pp. 945–948.