



HAL
open science

Strong edge-colouring and induced matchings

Hervé Hocquard, Pascal Ochem, Petru Valicov

► **To cite this version:**

Hervé Hocquard, Pascal Ochem, Petru Valicov. Strong edge-colouring and induced matchings. Information Processing Letters, 2013, 113 (19-21), pp.836-843. 10.1016/j.ipl.2013.07.026 . hal-00609454v4

HAL Id: hal-00609454

<https://hal.science/hal-00609454v4>

Submitted on 28 Jul 2013

HAL is a multi-disciplinary open access archive for the deposit and dissemination of scientific research documents, whether they are published or not. The documents may come from teaching and research institutions in France or abroad, or from public or private research centers.

L'archive ouverte pluridisciplinaire **HAL**, est destinée au dépôt et à la diffusion de documents scientifiques de niveau recherche, publiés ou non, émanant des établissements d'enseignement et de recherche français ou étrangers, des laboratoires publics ou privés.

Strong edge-colouring and induced matchings[☆]

Hervé Hocquard^a, Pascal Ochem^b, Petru Valicov^a

^aLaBRI (Université Bordeaux 1), 351 cours de la Libération, 33405 Talence Cedex, France

^bLIRMM - CNRS, 161 rue Ada, 34095 Montpellier Cedex 5 France

Abstract

A strong edge-colouring of a graph G is a proper edge-colouring such that every path of three edges uses three colours. An induced matching of a graph G is a subset \mathcal{I} of edges of G such that the graph induced by the endpoints of \mathcal{I} is a matching. In this paper, we prove the NP-completeness of strong 4, 5, and 6-edge-colouring and maximum induced matching in some subclasses of subcubic triangle-free planar graphs. We also obtain a tight upper bound for the minimum number of colours in a strong edge-colouring of outerplanar graphs as a function of the maximum degree.

Keywords: Strong edge-colouring, induced matching, NP-completeness, planar graphs, outerplanar graphs.

1. Introduction

A proper edge-colouring of a graph $G = (V, E)$ is an assignment of colours to the edges of the graph such that no two adjacent edges use the same colour. A *strong edge-colouring* (also called distance 2 edge-colouring) of a graph G is a proper edge-colouring of G , such that every path of length 3 ($uvxy$) uses three different colours. We denote by $\chi'_s(G)$ the *strong chromatic index* of G , which is the smallest integer k such that G can be strong edge-coloured with k colours. The *girth* of a graph is the length of its shortest cycle. We use Δ to denote the maximum degree of a graph. We say that two edges uv and xy are at distance 2 if u, v, x, y are all distinct and the graph induced by $\{u, v, x, y\}$ contains at least three edges.

Strong edge-colouring was introduced by Fouquet and Jolivet [5]. For a brief survey of applications of this type of colouring and some open questions, we refer the reader to [12]. In 1985, during a seminar in Prague, Erdős and Nešetřil gave a construction of graphs having strong chromatic index equal to $\frac{5}{4}\Delta^2$ when Δ is even and $\frac{1}{4}(5\Delta^2 - 2\Delta + 1)$ when Δ is odd. They conjectured that the strong chromatic index is bounded by these values and it was verified for $\Delta \leq 3$. Faudree *et al.* [3] conjectured that every bipartite graph has a strong edge-colouring with Δ^2 colours. The same authors [4] stated a new conjecture, claiming that the strong chromatic index of planar subcubic graphs is at most 9 and proved that $\chi'_s(G) \leq 4\Delta + 4$, for planar graphs with $\Delta \geq 3$. In this paper, we improve the latter result in the case of outerplanar graphs, showing that for an outerplanar graph G , $\chi'_s(G) \leq 3\Delta - 3$, for $\Delta \geq 3$. The interest in this bound is motivated by the existence of a class of outerplanar graphs having $\chi'_s(G) = 3\Delta - 3$, for any $\Delta \geq 3$.

Mahdian [9] proved that $\forall k \geq 4$, deciding whether a bipartite graph of girth g is strongly edge k -colourable, is NP-complete. He also proved that the problem can be solved in polynomial time for chordal graphs. Salavatipour [11] gave a polynomial time algorithm for strong edge-colouring of graphs of bounded tree-width. In this paper, we prove the NP-completeness of the problems of deciding whether a planar subcubic bipartite graph can be strongly edge-coloured with four, five, and six colours, for some values of the girth.

A related notion to strong edge-colouring is *induced matching*. An induced matching of G is a set of non-adjacent edges (matching) such that no two of them are joined by an edge in G . Clearly, a strong edge-colouring is a partition of the set of edges into a collection of induced matchings (see [3, 4]). Cameron proved [1] that finding a maximum induced matching in chordal graphs can

[☆]This research is supported by the ANR GraTel ANR-blan-09-blan-0373-01 and NSC99-2923-M-110-001-MY3 and the ANR GRATOS ANR-09-JCJC-0041-01.

be done in polynomial time and that the problem is NP-complete for bipartite graphs for every girth g . Lozin proved [8] that recognizing whether a graph G has an induced matching of size at least k is NP-complete, even when G is bipartite and of maximum degree 3. Duckworth *et al.* proved [2] that the problem is NP-complete even when restricted to planar cubic graphs. In fact all these results can be strengthened by extending the result of Duckworth *et al.* Namely, it can be easily shown that the problem remains NP-complete even if it is restricted to bipartite planar graphs with maximum degree 3 and with an arbitrarily large girth. We discuss this remark in the last section of this paper.

2. Strong edge-colouring

2.1. NP-completeness for subcubic planar graphs

The STRONG EDGE k -COLOURING problem is defined as follows:

INSTANCE: A graph G .

QUESTION: Does G have a strong edge-colouring with k colours?

The 3-COLOURING problem is defined as follows:

INSTANCE: A graph G .

QUESTION: Does G have a proper colouring with three colours?

3-COLOURING is proved to be NP-complete even when restricted to planar graphs with maximum degree 4 [6]. We reduce this restricted version of 3-COLOURING in order to prove the theorems of this section. STRONG EDGE k -COLOURING is in NP since it can be checked in polynomial time whether a given edge-colouring is a strong edge-colouring and uses at most k colours.

Theorem 1. *STRONG 4-EDGE-COLOURING is NP-complete for bipartite planar graphs with maximum degree 3 and girth at least g , for any fixed g .*

Proof

First, observe that by using the graphs in Figures 1a and 1b, we can force the edges at arbitrarily large distance to have the same colour if we put a sufficient number of claws between them (the dotted part of the figures). Moreover, depending on the parity of the number of claws between the edges having the same colour in a strong 4-edge-colouring, we can force vertices incident to these edges to be in the same part or in distinct parts of the bipartition. As an illustration in the Figures 1a and 1b, the bipartition is given by small and big vertices.

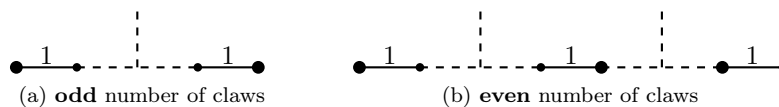

Figure 1: Transportation of a colour

Given a planar graph G with maximum degree 4, we construct a graph G' as follows. Every vertex v in G is replaced by a copy Q_v of the graph Q depicted in Figure 3a which contains three copies of the graph M shown in Figure 2. Note that M is bipartite (the bipartition is given in the picture by the big and small vertices) and of arbitrarily large girth. Therefore Q is bipartite and of arbitrarily large girth.

For every edge uv in G , if uv is the i th (respectively j th) edge incident to u (respectively v) in the same cyclic ordering, then we connect x_i of Q_u with x_j of Q_v and one of the vertices y_i^1 , y_i^2 with one of the vertices y_j^1 , y_j^2 such that the obtained graph is planar. These connections are done using an arbitrarily large number of claws as depicted in Figure 3b. The obtained graph G' is of maximum degree 3 and by the choice of the number of claws connecting the vertices, it is also bipartite and with an arbitrarily large girth. Finally, this graph can be built in polynomial time.

Up to a permutation of colours, the strong 4-edge-colouring of M given in Figure 2 is unique. We say that the *colour of Q* is the colour of the edges incident to the vertices x_i in Q (colour 2 in

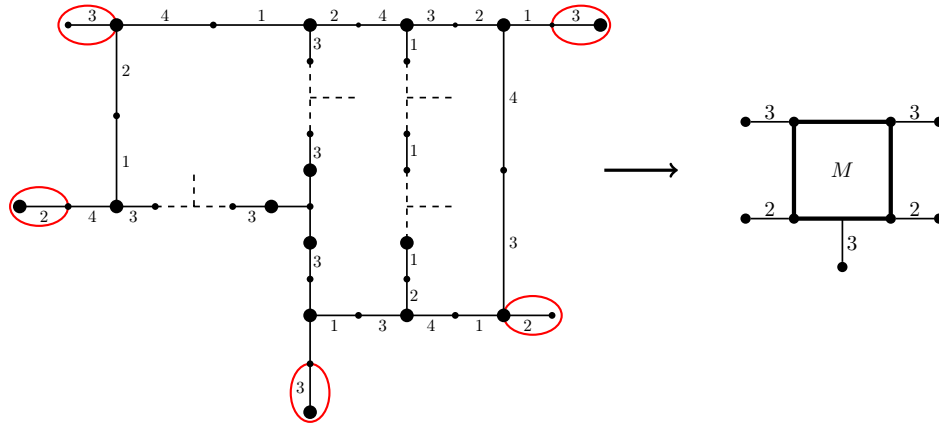

Figure 2: Sub-gadget M

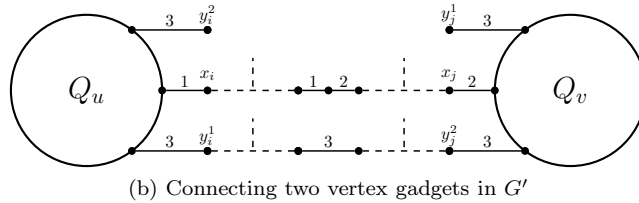
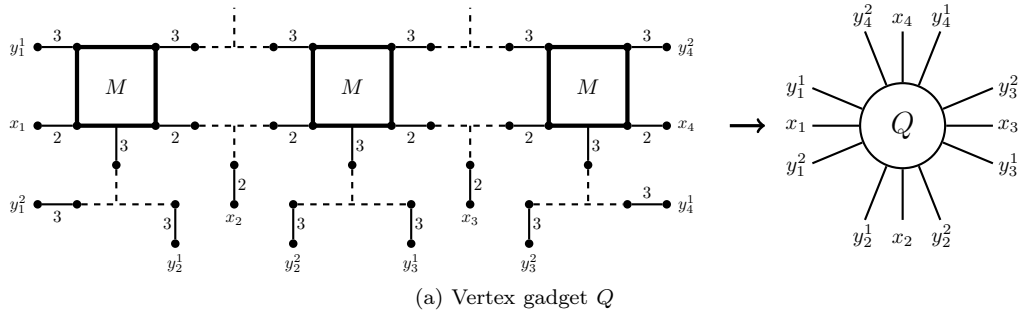

Figure 3: Vertex and edge gadgets for Theorem 1

Figure 3a). Also, the *forbidden colour* of Q is the colour of the edges incident to y_i^1 and y_i^2 (colour 3 in Figure 3a).

Figure 3b shows that for every edge $uv \in G$, Q_u and Q_v have distinct colours and the same forbidden colour. Since G is connected, all copies of Q have the same forbidden colour, say 3, and thus no copy of Q is coloured 3.

If G is 3-colourable, then for every vertex $v \in G$, we can assign the colour of v to Q_v and extend this to a strong 4-edge-colouring of G' . Conversely, given a strong 4-edge-colouring of G' , we obtain a 3-colouring of G by assigning the colour of Q_v to the vertex v . So G' is strong 4-edge-colourable if and only if G is 3-colourable, which completes the proof. \square

Theorem 2. *STRONG 5-EDGE-COLOURING is NP-complete for planar bipartite graphs with maximum degree 3 and girth 8, and for planar graphs with maximum degree 3 and girth 9.*

Proof

In the following, we will give the proof for the case of girth 8 since the same argument applies for the case of girth 9.

Given a planar graph G with maximum degree 4 forming an instance of 3-COLOURING of planar graphs of maximum degree 4, we construct a graph G' as follows. Every vertex v in G is replaced by a copy Q_v of the vertex gadget Q depicted in Figure 4. For every edge uv in G , we

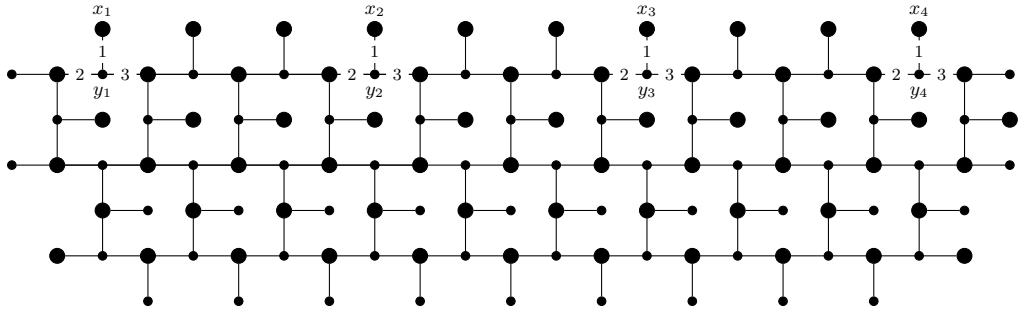

Figure 4: Vertex gadget for the case of girth 8 of Theorem 2

identify a vertex x_i of Q_u with a vertex x_j of Q_v and add a vertex of degree 3 adjacent to the common vertex of Q_u and Q_v , as depicted in Figure 6. We identify these vertices in such a way that the obtained graph G' is planar. Small and big vertices in Figure 4 show that Q is bipartite and thus G' is bipartite too. Moreover, G' has no cycle of length at most 7, hence G' has girth 8.

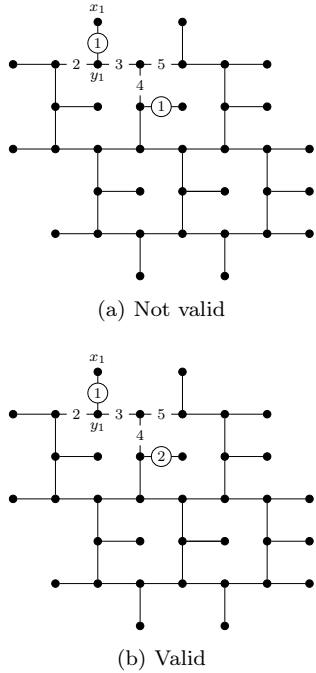

Figure 5: Two possible 5-edge-precolourings of the graph of Figure 4

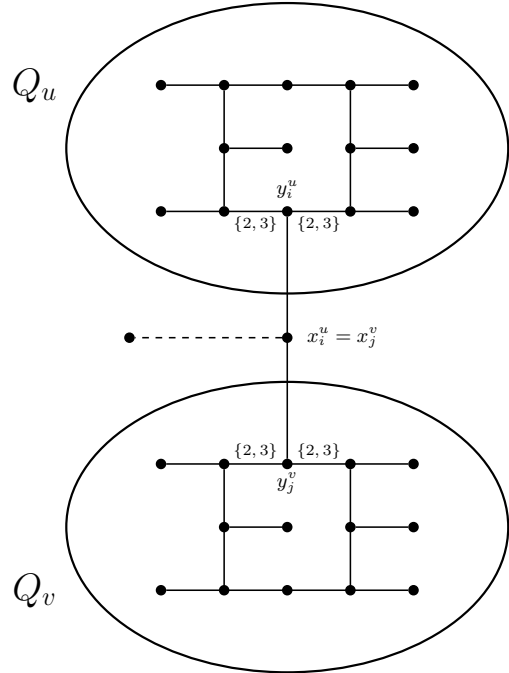

Figure 6: Edge gadget for the case of girth 8 of Theorem 2

We claim that up to permutation of colours, the strong 5-edge-colouring of Q given in Figure 4 is unique. To see this, note that careful checking shows that the strong 5-edge-precolouring of the subgraph of Q depicted in Figure 5a, cannot be extended to the whole subgraph without using a sixth colour. Therefore, if it is possible to give a strong 5-edge-colouring of Q , the only way to do it is using the strong 5-edge-precolouring of this subgraph of Q as depicted in Figure 5b. Now, using this observation, it is easy to prove that the strong 5-edge-colouring of Q given in Figure 4 is unique up to permutation of colours.

We say that the *colour of Q* is the colour of the edges $x_i y_i$ in Q (colour 1 in Figure 4). Also, the *forbidden colours of Q* are the colours of the edges incident to y_i in Q , different from $x_i y_i$ (colours 2 and 3 in Figure 4). Figure 6 shows that for every edge $uv \in G$, Q_u and Q_v have distinct colours and same forbidden colours. Since G is connected, all copies of Q have the same forbidden colours, 2 and 3, and thus no copy of Q is coloured 2 or 3.

If G is 3-colourable, then for every vertex $v \in G$, we can assign the colour of v to Q_v and extend

this to a strong 5-edge-colouring of G' . Conversely, given a strong 5-edge-colouring of G' , we obtain a 3-colouring of G by assigning the colour of Q_v to the vertex v . So G' is strong 5-edge-colourable if and only if G is 3-colourable, which completes the proof.

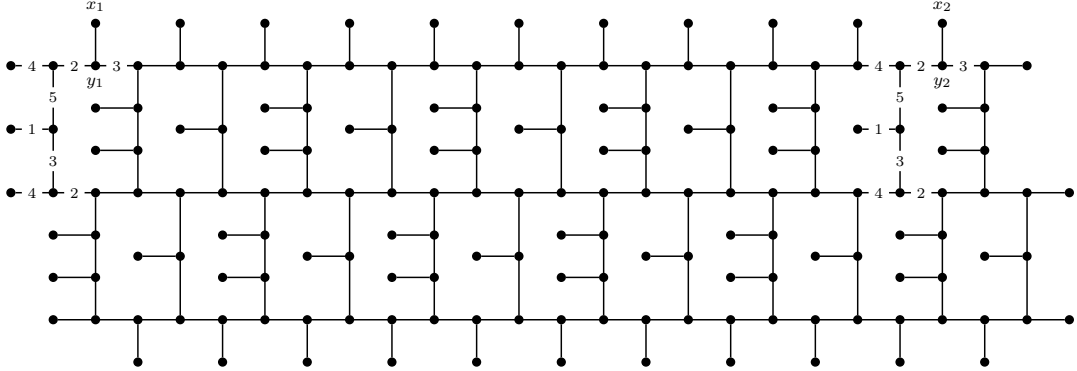

Figure 7: Vertex gadget for the case of girth 9 of Theorem 2

For the case of girth 9 the same argument applies by using as a vertex gadget the graph of Figure 7, while the edge gadget is the same. However, checking that the strong 5-edge-colouring of this gadget is unique (as given in the figure) is much more tedious than for the vertex gadget of girth 8. For the detailed proof, see the Ph.D. thesis of the third author [12]. \square

Theorem 3. *STRONG 6-EDGE-COLOURING is NP-complete for planar bipartite graphs with maximum degree 3.*

Proof

For a graph G forming an instance of 3-COLOURING of planar graphs with maximum degree 4, we construct a graph G' such that G is 3-colourable if and only if G' is strongly 6-edge-colourable. The construction uses *meta-edges* represented as dashed segments in the figures below. There are two types of meta-edges: 2-meta-edges and 3-meta-edges. They consist in a chain of two or three 4-cycles with pendant edges, as depicted in Figures 8a and 8b, respectively. Both types of meta-edge have the following properties:

- They propagate the colour, that is, in any strong 6-edge-colouring, all the horizontal edges in Figure 8 have the same colour. We define this common colour as the colour of the meta-edge.
- They destroy the constraints distance 2 that exist for a classical edge. This means that two edges incident to distinct ends of a meta-edge can have the same colour.

In the following, we give some constructions using generic meta-edges. Then, we will specify the type of each meta-edge of G' .

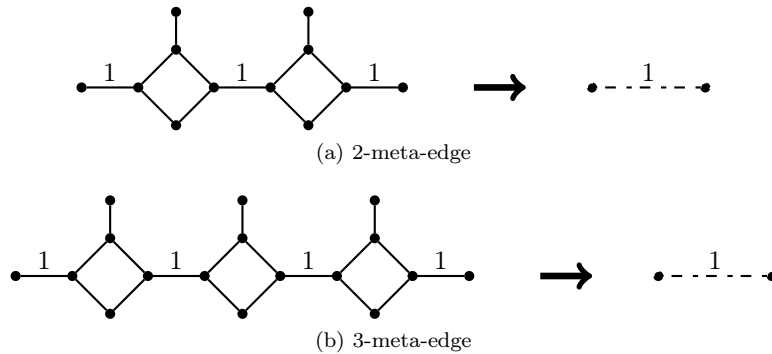

Figure 8: Transportation of a colour in a strong 6-edge-colouring by using meta-edges

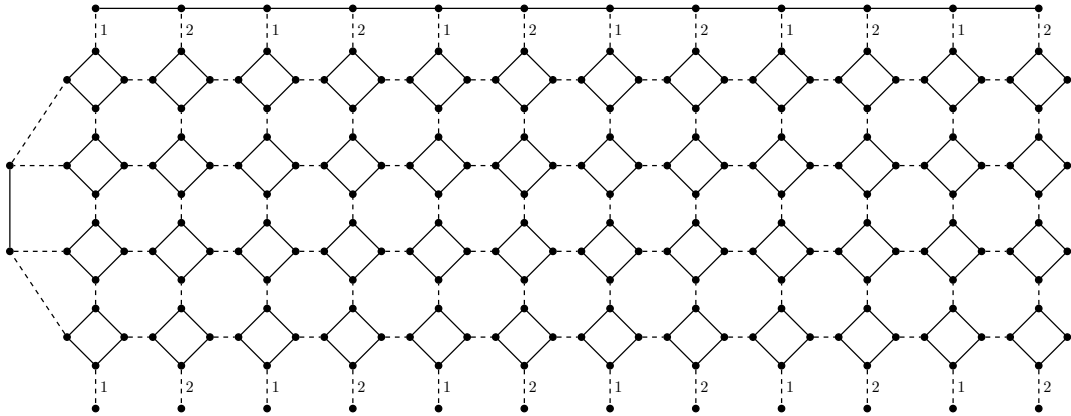

Figure 9: Graph P

First, we build the planar graph P of Figure 9. Up to permutation, the colours 1 and 2 are forced in any strong 6-edge-colouring of the graph P of Figure 9. We call *pendant edges* the edges of P incident to a vertex of degree one and coloured 1 and 2 in the figure.

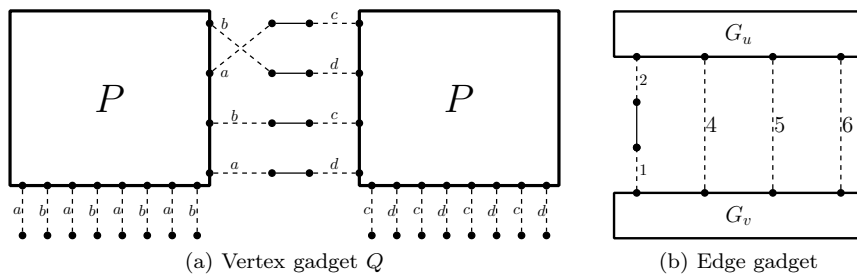

Figure 10: Vertex and edge gadgets for Theorem 3

Next, we construct the vertex gadget as depicted in Figure 10a. Take two copies of graph P with six pairs of pendant edges (coloured $\{a, b\}$ and $\{c, d\}$ respectively) and connect them such that the colours a, b, c, d are all distinct and the obtained graph has eight pairs of pendant edges. It is easy to see that the obtained graph Q is subcubic and such that $\chi'_s(Q) = 6$. The gadget that replaces a vertex v of G in G' is obtained from a not necessarily planar embedding of a copy of Q such that there are four quadruples of edges coloured a, b, c , and d in this order. Note that Q may be drawn so that the only crossing edges are the meta-edges corresponding to these quadruples and so that no two meta-edges with the same colour cross. Now, using the following observation, each crossing of meta-edges can be removed so that the obtained graph is planar.

Observation 4. *Two crossing meta-edges with distinct colours can be uncrossed using the gadget in Figure 11.*

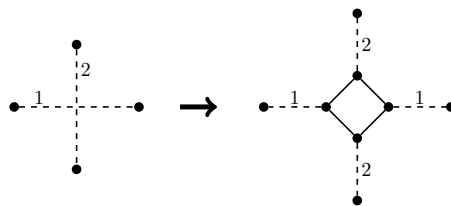

Figure 11: Replacing crossing meta-edges with distinct colours

Consider four pendant edges (one for each quadruple) of the obtained graph having the same colour, say colour a . For each of these edges, label its incident vertex of degree 1, x_k^v ($1 \leq k \leq 4$).

For an edge uv of G , in G' we identify the vertices x_i^u and x_j^v and connect the other three pairs of edges as shown in Figure 10b. Note that if G' is connected, then in any strong 6-edge-colouring of G' , the colours 4, 5 and 6 used in Figure 10b are not used to colour any edge incident to some vertex labelled x_i^v .

Let H be the graph obtained from G' by removing the meta-edges but keeping the end vertices of the meta-edges. The connected components of H are paths and 4-cycles, so H is bipartite. Consider an arbitrary 2-vertex-colouring of H and extend this 2-vertex-colouring to G' as follows. If the end vertices of a meta-edge of G' have the same colour in the 2-colouring of H , then this meta-edge is a 3-meta-edge, otherwise it is a 2-meta-edge. Observe that this makes G' bipartite and the construction of G' can be done in polynomial time.

We claim that the obtained graph G' is strongly 6-edge-colourable if and only if G is 3-colourable. Similarly to the proof of Theorem 1, the forbidden colours in a strong 6-edge-colouring of the graph G' are the colours of edges not incident to some vertex labelled x_i^v . Hence, in G' there are three forbidden colours. If G is 3-colourable then we can assign the colour of a vertex v of G to the pendant edge of G_v incident to x_i^v in G' and extend this colouring to a valid strong 6-edge-colouring of G' . Conversely, given a strong 6-edge-colouring of G' , since there are three forbidden colours for G' , we can use the colour of the edge incident to x_i^v in the graph G_v to colour v in G .

□

2.2. Outerplanar graphs

Theorem 5. For every outerplanar graph G with maximum degree $\Delta \geq 3$, $\chi'_s(G) \leq 3\Delta - 3$.

Proof

We define the partial order \preceq on graphs such that $G_1 \prec G_2$ if and only if

- $|E(G_1)| < |E(G_2)|$ or
- $|E(G_1)| = |E(G_2)|$ and G_1 contains strictly more pendant edges than G_2 .

Let $k \geq 3$ be an integer and G be an outerplanar graph with maximum degree k such that $\chi'_s(G) > 3k - 3$ and that is minimal with respect to \preceq .

We first show that G does not contain Configuration 1 depicted in Figure 12a. That is, two adjacent vertices x and y , such that the graph G' obtained from G by removing the set S of edges incident to x or y contains two edges in distinct connected components.

Suppose that G contains Configuration 1. Let G_1, \dots, G_p be the connected components of G' . Since they contain fewer edges than G , by minimality of G with respect to \preceq , the graphs induced by the edges of $G_i \cup S$ admit a strong edge-colouring with at most $3k - 3$ colours. Since the colours of the edges of S are distinct, we can permute the colours in the colouring of $G_i \cup S$ so that the colouring of S is the same in every $G_i \cup S$. By gluing up the graphs $G_i \cup S$, we obtain a valid strong edge-colouring of G since the distance between an edge in G_i and an edge in $G_{i'}$ for $i \neq i'$ is at least 3. This is a contradiction.

Configuration 2 depicted in Figure 12b consists of a vertex u adjacent to at most one vertex x with degree at least 2 and to at least one vertex v of degree 1. This configuration cannot exist in G , as otherwise we could obtain a colouring of G by extending a colouring of $G \setminus \{uv\}$.

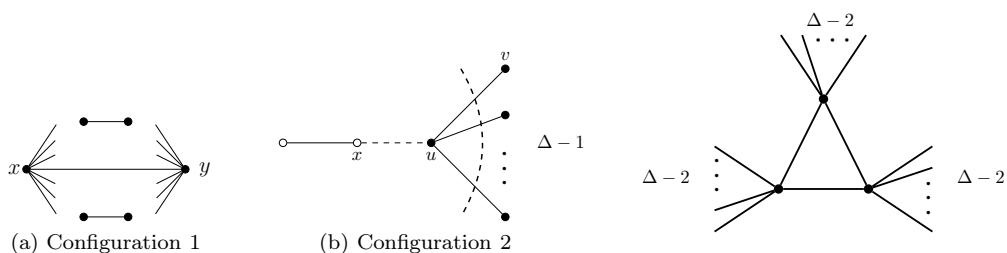

Figure 12: Forbidden configurations

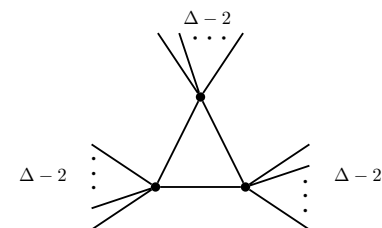

Figure 13: Example of outerplanar graph such that $\chi'_s(G) = 3\Delta - 3$.

Let G' be the graph induced by the vertices of G of degree at least 2. Since Configuration 2 is forbidden in G , G' has minimum degree 2.

We claim that G' is 2-connected. Suppose the contrary and let v be a vertex of G' such that $G' - v$ is disconnected. Let G'_1, \dots, G'_l be the connected components of $G' - v$. Let $E[v]$ be the graph induced by the edges incident to v in G ($E[v]$ is thus a star). Observe that each of the graphs $G'_i \cup E[v]$ with $i \in \{1, \dots, l\}$ is smaller than G with respect to \preceq and thus for each of them there exists a strong edge-colouring ϕ_i using at most $3\Delta_i - 3$ colours, where $\Delta_i \leq k$ is the maximum degree of $G'_i \cup E[v]$. One can permute the colours of the edges incident to v for every ϕ_i such that the colouring of the edges of $E[v]$ is the same in every $G'_i \cup E[v]$. The colourings ϕ_1, \dots, ϕ_k provide a valid strong edge-colouring of G' and this is a contradiction.

Let C be the cycle of the outer-face of G' . Since Configuration 1 is forbidden in G , the chords of C join vertices at distance 2 in the cyclic order. One can check that if C contains at most 4 vertices then the theorem holds. So C contains n vertices ($n \geq 5$) v_1, \dots, v_n in cyclic order. In G these vertices might be adjacent to some additional vertices of degree 1.

Let us suppose that C contains a chord, say the edge v_1v_3 . Notice that since Configuration 1 is forbidden, v_2 is only adjacent to v_1 and v_3 . The graph H is obtained from G by splitting the vertex v_2 into v'_2 , which is only adjacent to v_1 , and v''_2 , which is only adjacent to v_3 . Notice that H and G have the same number of edges but H has two more pendant edges than G , so $H \prec G$. The graph H thus admits a valid strong edge-colouring using $3k - 3$ colours and this colouring remains valid if we identify v'_2 and v''_2 to form G (no edges at distance at least 3 in H are at distance at most 2 in G). This shows that vertices of degree at least 2 in G form a chordless cycle.

To finish the proof, we have to consider only the worst case of graphs of this form, where every vertex on the chordless cycle is incident to $\Delta(G) - 2$ pendant edges. It is easy to check that if $\Delta(G) = k = 3$, then we can colour G using at most $3k - 3 = 6$ colours. We iteratively construct a suitable colouring for larger values of k : when k is incremented by 1, there is at most one new pendant edge for each vertex on the cycle and three more available colours. We use the three new colours to colour the new edges such that two new edges incident to adjacent vertices get distinct colours. The graph of Figure 13 is the one for which at each step we need to add exactly three colours, thus reaching the bound of $3k - 3$ colours. □

3. Induced Matchings

The INDUCED MATCHING problem is defined as follows:

INSTANCE: A graph G and an integer k .

QUESTION: Is there an induced matching of size k in G ?

Theorem 6 (Duckworth *et al.* [2]). *INDUCED MATCHING is NP-complete even when restricted to planar cubic graphs.*

Corollary 7. *INDUCED MATCHING is NP-complete for planar bipartite graphs with maximum degree 3 and girth at least g , for any fixed g .*

Proof

Consider an edge uv of a planar cubic graph G . Subdivide uv in order to obtain a path $uv_1v_2v_3v$, where v_1, v_2, v_3 are vertices of degree 2. Then G has an induced matching of size k if and only if the new obtained graph has an induced matching of size $k + 1$.

Using this observation it is easy to see that one can obtain a graph G' from a planar cubic graph G by subdividing every edge of G with $6l + 3$ vertices. If G has n vertices and m edges, then G' has $n + (6l + 3)m$ vertices and $(6l + 3)m$ edges. Clearly G' is bipartite, planar, subcubic and of girth at least $3(6l + 4)$. One can also observe that G has an induced matching of size k if and only if G' has an induced matching of size $k + (2l + 1)m$. □

Note: After receiving the reviews on this paper the authors found that the result of Duckworth *et al.* [2] could be easily extended in order to prove the main result of this section. Thus this new proof is much easier than the one written in the paper initially. However, we provide the initial proof in the Appendix as we think that the ideas are nice and could be interesting to the reader.

We would like to thank the referees for multiple comments which helped improving this paper.

- [1] K. Cameron. Induced matchings, *Discrete Applied Mathematics* **24** (1989), 97-102.
- [2] W. Duckworth, D.F. Manlove and M. Zito. On the approximability of the maximum induced matching problem, *Journal of Discrete Algorithms* **3** (2005), 79-91.
- [3] R.J. Faudree, A. Gyárfas, R.H. Schelp and Zs. Tuza. Induced matchings in bipartite graphs, *Discrete Mathematics* **78** (1989), 83-87.
- [4] R.J. Faudree, A. Gyárfas, R.H. Schelp, and Zs. Tuza. The strong chromatic index of graphs, *Ars Combinatoria* **29B** (1990), 205-211.
- [5] J.L. Fouquet and J.L. Jolivet. Strong edge-colorings of graphs and applications to multi-k-gons, *Ars Combinatoria A* **16** (1983), 141-150.
- [6] M.R. Garey, D.S. Johnson, and L.J. Stockmeyer. Some simplified NP-Complete graph problems, *Theoretical Computer Science* **1(3)** (1976), 237-267.
- [7] J. Kratochvíl. A special planar satisfiability problem and a consequence of its NP-Completeness, *Discrete Applied Mathematics* **52** (1994), 233-252.
- [8] V.V. Lozin. On maximum induced matchings in bipartite graphs, *Information Processing Letters* **81** (2002), 7-11.
- [9] M. Mahdian. On the computational complexity of strong edge coloring, *Discrete Applied Mathematics* **118(3)** (2002), 239-248.
- [10] S.T. McCormick. Optimal approximation of sparse Hessians and its equivalence to a graph coloring problem, *Math. Programming* **26** (1983), 153-171.
- [11] M.R. Salavatipour. A polynomial time algorithm for strong edge coloring of partial k-trees, *Discrete Applied Mathematics* **143(1-3)** (2004), 285-291.
- [12] P. Valicov. On packing, coloring and identification problems, Ph.D. thesis, University Bordeaux 1, 2012.

Appendix A. Alternative proof of Theorem 7

The NP-complete problem PLANAR $(3, \leq 4)$ -SAT is defined as follows [7]:

INSTANCE: A collection \mathcal{C} of clauses over a set \mathcal{X} of boolean variables, where each clause contains exactly three distinct literals (a variable x_i or its negation $\overline{x_i}$) and each variable appears at most four times, such that the variable-clause incidence graph is planar.

QUESTION: Can \mathcal{C} be satisfied, *i.e.*, is there a truth assignment of the variables of \mathcal{X} such that each clause contains at least one true literal?

We reduce PLANAR $(3, \leq 4)$ -SAT to INDUCED MATCHING. We first prove the result for planar graphs with maximum degree 3 and girth 12 and then explain how to restrict further the proof to bipartite graphs with any fixed girth.

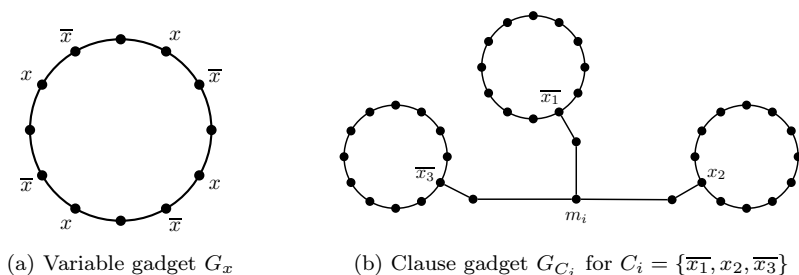

Figure A.14: Variable and clause gadgets

For an instance of PLANAR $(3, \leq 4)$ -SAT with a collection of clauses \mathcal{C} and a set \mathcal{X} of boolean variables, we build the graph G as follows. For each variable, make a copy of the graph depicted in Figure A.14a. For each clause C_i , make a copy of the graph G_{C_i} by connecting each variable gadget as shown in Figure A.14b such that G is planar (this can be done since the variable-clause incidence graph is planar). Also, make sure that each edge $x\bar{x}$ in a variable gadget is incident to at most one clause gadget. The construction of G can be done in polynomial time in terms of the size of \mathcal{C} .

We show that \mathcal{C} is satisfiable if and only if G contains an induced matching \mathcal{I} of size $k = 4|\mathcal{X}| + |\mathcal{C}|$.

Suppose \mathcal{C} is satisfiable. We build the induced matching \mathcal{I} of G as follows. For every variable subgraph G_x , we put in \mathcal{I} the four edges belonging to the cycle that are not incident to a vertex corresponding to a literal with boolean value TRUE. For every clause subgraph G_{C_i} , we put in \mathcal{I} an edge incident to m_i and pointing in the direction of a literal with boolean value TRUE. Such a literal exists since the clause is satisfied. Clearly, \mathcal{I} is an induced matching and its size is k .

Suppose now that G has an induced matching \mathcal{I} of size k . We show a truth assignment of the variables of \mathcal{X} such that \mathcal{C} is satisfiable.

Given a variable gadget G_x , we consider the graph G'_x induced by G_x and the edges incident to G_x . One can check that at most four edges of G'_x belong to \mathcal{I} . Hence, for every subgraph G_{C_i} , \mathcal{I} must contain at least one of the edges incident to m_i . On the other hand since \mathcal{I} is an induced matching it can contain only one such edge - call it e_i . More generally, this implies that no edge of G'_x outside G_x can belong to \mathcal{I} . Let l_j be the edge of a vertex gadget adjacent to e_i and therefore corresponding to a literal l_j . We build a set of edges \mathcal{I}' in the following way: for every clause gadget G_{C_i} , we set $e_i \in \mathcal{I}'$, and for every vertex gadget of G_{C_i} , we add to \mathcal{I}' all the edges adjacent to \bar{l}_j and not adjacent to l_j (this is possible since no edge of G'_x outside G_x is in \mathcal{I}). Clearly, \mathcal{I}' is an induced matching and $|\mathcal{I}'| = |\mathcal{I}|$. For every clause gadget G_{C_i} , assign the value TRUE to the literal represented by the edge adjacent to e_i . Hence every clause of \mathcal{C} has a TRUE literal and therefore \mathcal{C} is satisfiable.

In the proof above, the constructed graph is planar with maximum degree 3, but it is not bipartite and the girth is 12. It is easy to see that it is possible to use cycles of size $6s$ for the variable gadgets and to branch the clause gadgets on them in such a way that the resulting graph is bipartite and has any given fixed girth. The reduction then uses $k = 2s|\mathcal{X}| + |\mathcal{C}|$.