



HAL
open science

Effect of advancing the closing angle of the intake valves on diffusion-controlled combustion in a HD Diesel engine

J. Benajes, S. Molina, J. Martín, R. Novella

► To cite this version:

J. Benajes, S. Molina, J. Martín, R. Novella. Effect of advancing the closing angle of the intake valves on diffusion-controlled combustion in a HD Diesel engine. *Applied Thermal Engineering*, 2010, 29 (10), pp.1947. 10.1016/j.applthermaleng.2008.09.014 . hal-00608408

HAL Id: hal-00608408

<https://hal.science/hal-00608408>

Submitted on 13 Jul 2011

HAL is a multi-disciplinary open access archive for the deposit and dissemination of scientific research documents, whether they are published or not. The documents may come from teaching and research institutions in France or abroad, or from public or private research centers.

L'archive ouverte pluridisciplinaire **HAL**, est destinée au dépôt et à la diffusion de documents scientifiques de niveau recherche, publiés ou non, émanant des établissements d'enseignement et de recherche français ou étrangers, des laboratoires publics ou privés.

Accepted Manuscript

Effect of advancing the closing angle of the intake valves on diffusion-controlled combustion in a HD Diesel engine

J. Benajes, S. Molina, J. Martín, R. Novella

PII: S1359-4311(08)00386-4
DOI: [10.1016/j.applthermaleng.2008.09.014](https://doi.org/10.1016/j.applthermaleng.2008.09.014)
Reference: ATE 2629

To appear in: *Applied Thermal Engineering*

Received Date: 17 September 2007
Revised Date: 10 March 2008
Accepted Date: 23 September 2008

Please cite this article as: J. Benajes, S. Molina, J. Martín, R. Novella, Effect of advancing the closing angle of the intake valves on diffusion-controlled combustion in a HD Diesel engine, *Applied Thermal Engineering* (2008), doi: [10.1016/j.applthermaleng.2008.09.014](https://doi.org/10.1016/j.applthermaleng.2008.09.014)

This is a PDF file of an unedited manuscript that has been accepted for publication. As a service to our customers we are providing this early version of the manuscript. The manuscript will undergo copyediting, typesetting, and review of the resulting proof before it is published in its final form. Please note that during the production process errors may be discovered which could affect the content, and all legal disclaimers that apply to the journal pertain.

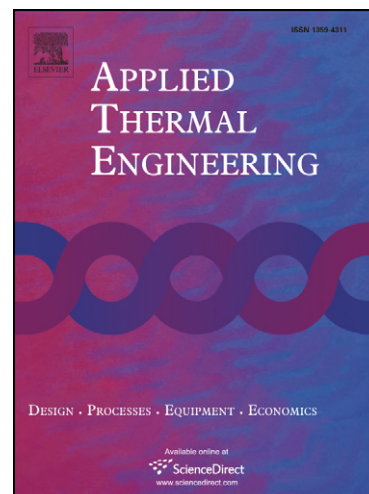

First revision of paper draft:

Effect of advancing the closing angle of the intake valves on diffusion-controlled combustion in a HD Diesel engine

First revision of paper draft:

Effect of advancing the closing angle of the intake valves on diffusion-controlled combustion in a HD Diesel engine

J. Benajes*, S. Molina, J. Martín and R. Novella

CMT-Motores Térmicos

Universidad Politécnica de Valencia

Camino de Vera s/n, 46022, Valencia (Spain)

Tel. (0034) 96 387 76 50 / Fax (0034) 96 387 76 59

Abstract

An experimental investigation has been performed on the modification of in-cylinder gas thermodynamic conditions by advancing the intake valve closing angle in a HD Diesel engine. The consequences on the diffusion-controlled combustion process have been analysed in detail, including the evolution of exhaust emissions and engine efficiency. This research has been carried out at full load (100%) and low engine speed (1200 rpm) with the aim of generating a long and stable diffusion-controlled combustion process. The intake oxygen mass concentration was kept at 17.4% to obtain low NO_x levels in all cases. The required flexibility on intake valve motion has been attained by means of an electro-hydraulic variable valve actuation system. The results obtained from advancing the intake valve closing angle (IVC) have shown an important reduction on in-cylinder gas pressure and density, whereas the gas temperature showed less sensitivity. Consequently, the diffusion-controlled combustion process is slowed down mainly due to the lower in-cylinder gas density and oxygen availability. Important effects of advancing IVC have also been observed on pollutant emissions and engine efficiency. Where NO_x production decreases, soot emissions increase. Finally, the results of pollutant emissions and engine efficiency have been compared with those obtained retarding the start of injection.

Key words:

Diesel engines, Diesel combustion, Diesel pollutant emissions, variable valve actuation

* *Corresponding author*

Email: jbenajes@mot.upv.es

Phone: (0034) 96 387 76 55 // Fax: (0034) 96 387 76 59

1 Introduction

In the last decade, the direct injection Diesel engine is growing in popularity mainly due to its high thermal efficiency. This competitive efficiency, together with its high reliability, make the direct injection Diesel engine particularly suitable for heavy-duty applications, like medium and heavy trucks or power generation engines.

However, the diffusion-controlled combustion characteristic of Diesel engines generates significant levels of nitrous oxides (NO_x) and soot emissions [1, 2]. One of the main challenges in the frame of Diesel engine combustion research is how to attain extremely low levels of NO_x and soot emissions without worsening the competitive Diesel engine thermal efficiency.

With the aim of avoiding the emission drawbacks of Diesel engines, new advanced combustion processes based on replacing the diffusion-controlled combustion by a totally (or partially) premixed compression-ignition combustion process are being investigated, such as the HCCI [3] and the PCI [4] concepts. Despite the interesting emission results, most of these advanced combustion processes can be only applied at low and medium engine load, switching to conventional diffusion-controlled combustion at high load operation conditions [5]. Therefore, improving the characteristics of diffusion-controlled combustion in direct injection Diesel engines for reducing pollutant production is still required to fulfil the future emission standards, especially at high load conditions.

Keeping the injection settings constant, diffusion-controlled combustion basically depends on instantaneous in-cylinder gas chemical composition and thermodynamic

First revision of paper draft:

Effect of advancing the closing angle of the intake valves on diffusion-controlled combustion in a HD Diesel engine

conditions. In-cylinder thermodynamic conditions during the closed cycle (compression, combustion and expansion) can be directly controlled by adjusting the intake valve closing angle (IVC), which defines the total intake mass flow rate and the effective compression ratio of the engine [6]. Interesting improvements in terms of NO_x emissions and fuel consumption have been obtained with this strategy in spark ignition engines [7, 8]. The potential of advancing IVC, together with turbocharging, for NO_x emissions control has also been explored in Diesel engines with success, achieving reductions in the range of 10-20% of this pollutant [6, 9, 10].

Thus, the main objective of this investigation has been to improve the knowledge of the influence of advancing IVC on in-cylinder conditions and how it affects the diffusion-controlled combustion, exhaust emissions and engine efficiency. In this research, the required intake valve motion flexibility has been attained by an electro-hydraulic variable valve actuation system.

Finally, pollutant emissions and engine efficiency results obtained from advancing IVC have been compared to those attained with a conventional injection strategy based on retarding the start of injection.

3 Experimental setup

The engine used in this work was a single-cylinder, four-stroke, direct-injection Diesel research engine with 1.8 litre displacement. Detailed specifications of the engine are given in Table 1. The engine was installed in a fully instrumented test cell, with all the auxiliary facilities required for its operation and control. Figure 1 shows a scheme of the installation.

First revision of paper draft:

Effect of advancing the closing angle of the intake valves on diffusion-controlled combustion in a HD Diesel engine

When exhaust gas recirculation (EGR) needs to be produced, exhaust gas is taken from the exhaust settling chamber, cooled by a gas-water heat exchanger, heated inside the EGR settling chamber to the desired temperature, and finally introduced into the intake pipe, as shown in Figure 1. In this study, the intake temperature (after mixing fresh air and EGR) was kept at a constant value of 66° C in all the tests. The exhaust backpressure produced by the turbine in the real engine (0.04 MPa) was replicated by a valve placed in the exhaust system, controlling the pressure in the exhaust settling chamber. This backpressure also ensures enough EGR mass flow rate in all operating conditions.

The molar concentration of NO_x, CO, HC, intake and exhaust CO₂, and O₂ was measured with specific state-of-the-art analysers. Determining the EGR rate was carried out using experimental measurements of intake and exhaust CO₂ concentrations. Smoke emission was measured with a variable sampling smoke meter, providing results directly in FSN (Filter Smoke Number). These units were transformed into dry soot mass emissions by means of a suitable correlation [11].

At every engine operating point, the in-cylinder pressure traces from a piezoelectric transducer were recorded during 50 consecutive engine cycles in order to compensate for variability in engine operation. The actual fuel injection rate was measured during 50 consecutive engine cycles in a commercial test rig using the Bosch system [12].

The variable valve actuation in the engine was attained through an electro-hydraulic camless system patented by Sturman Industries [13]. The system flexibility includes variable timing, variable duration and variable lift for each valve independently. If necessary, two intake and/or exhaust events per cycle can be easily carried out. The

First revision of paper draft:

Effect of advancing the closing angle of the intake valves on diffusion-controlled combustion in a HD Diesel engine

system, adapted for a single cylinder engine configuration, requires a specific oil circuit with pumps driven by electrical motors, independent of the engine. At the moment, these pumps are oversized and their power consumption has not been considered in the estimations of engine efficiency. Additional information about this VVA system and its application on HD Diesel engines can be found in the work of Lombard et al. [14].

The values for IVC presented in this paper correspond to the target values introduced into the VVA control software. These are the angles for which the intake valves lift is around 1 mm, but the actual IVC occurs around 15 cad after this logical value because the VVA control software introduces a final closing ramp with low slope to avoid strong impacts between the valves and the cylinder head. In this investigation, the values of in-cylinder gas thermodynamic conditions at IVC have been calculated at the actual IVC.

4 Methodology and test conditions

The methodology followed in this investigation has been based on the analysis of the isolated effect of advancing IVC at three different SoI, whereas the other parameters were kept constant.

Table 2 contains the complete test plan designed for this experimental work. The basic engine operation conditions correspond to mode A100 of the European Steady Cycle (ESC) for heavy-duty engines, defined by 1200 rpm engine speed and a constant injected fuel mass, m_f , of 232.3 mg per cycle.

Three values of IVC timing (including the base-line) and three start of injection angles (SoI) were tested independently. The intake oxygen concentration was changed

First revision of paper draft:

Effect of advancing the closing angle of the intake valves on diffusion-controlled combustion in a HD Diesel engine

by recirculating the required amount of exhaust gases, starting from an initial 27% EGR rate. Advancing IVC reduces the intake fresh air mass flow and, as a consequence of the lower air/fuel ratio, the oxygen concentration in the exhaust gas also decreases.

Therefore, the EGR rate had to be reduced when operating with different IVC to keep the intake oxygen concentration constant. The objective with this procedure was to isolate the main effect of advancing IVC, which changes the in-cylinder gas thermodynamic conditions.

All these tests were carried out with one conventional injection event close to TDC. Other advanced injection strategies are out of the scope of this research at the present time. At each engine operating point, the filtered average pressure and injection rate signals were used as inputs for a combustion diagnostic model [15, 16].

The instantaneous flame temperature T_f has been calculated assuming constant pressure at each calculation step, and that the absolute enthalpy of the reactants at the initial state equals the absolute enthalpy of the products at the final state. The piston movement has been taken into account to estimate the instantaneous reactants temperature during combustion. This temperature has been estimated assuming an adiabatic compression starting from the in-cylinder gas temperature at the start of combustion (SoC), so that the temperature of the reactants is not the mean in-cylinder gas temperature. The products composition has been determined following the scheme proposed by Wey [17]. Since T_f and the composition of the final products are coupled, an iterative process is required to solve the problem.

5 Results and discussion

The analysis of the results has been divided in three sections following a logical structure. The first section focuses on the effect of advancing IVC on in-cylinder conditions. The second section analyses the diffusion-controlled combustion process in detail. The third section discusses the trends followed by pollutant emissions and engine efficiency, relating these with the differences observed in combustion process.

5.1 In-cylinder conditions

Since the in-cylinder conditions are independent from the injection parameters, only the results for the most retarded SoI (+2 cad aTDC) will be discussed. The main reason is to keep a complete compression process up to TDC. Figure 2 shows the most important parameters related to the in-cylinder conditions at the three IVC tested.

Advancing IVC shortens the duration of the intake process, which reduces the total mass flow rate through the engine. Figure 2 corroborates this reduction in m_{IVC} , and ρ_{TDC} , but also in A/F . Thus, it is important to highlight that the lower A/F also implies less Y_{O_2} in the exhaust gases, so the EGR rate should be reduced to keep the intake Y_{O_2} constant.

Early IVC also decreases the effective compression ratio, CR_{eff} . At the earliest IVC, CR_{eff} was decreased from 16 to 14. The theoretical effect of CR_{eff} on pressure and temperature at the end of the compression stroke (p_{TDC} and T_{TDC}) can be estimated considering the compression process as a polytropic evolution with constant exponent k (typical k values are between 1.35 and 1.38).

First revision of paper draft:

Effect of advancing the closing angle of the intake valves on diffusion-controlled combustion in a HD Diesel engine

With this assumption, the relation between CR_{eff} , p_{TDC} and T_{TDC} is given by the equations (1) and (2).

$$p \cdot V^k = const \rightarrow p_{TDC} = p_{IVC} \cdot CR_{eff}^k \quad (1)$$

$$T \cdot V^{k-1} = const \rightarrow T_{TDC} = T_{IVC} \cdot CR_{eff}^{k-1} \quad (2)$$

Considering these two equations, p_{TDC} is proportional to CR_{eff}^k and T_{TDC} is proportional to CR_{eff}^{k-1} , so p_{TDC} is more sensitive to CR_{eff} than T_{TDC} . This explains theoretically why the reduction in p_{TDC} at earlier IVC is much greater than that observed in T_{TDC} .

The results shown in Figure 3 confirm how the effect of CR_{eff} is more pronounced in p and ρ than in T . Comparing the earliest and the nominal IVC profiles; p_{TDC} and ρ_{TDC} are both reduced about 21.5%, whereas T_{TDC} decreases only by 2.3%.

In addition, recovering m_{IVC} by increasing p_{in} at the earliest IVC will recover the nominal ρ_{TDC} and increase p_{TDC} until values close to the nominal case, but T_{TDC} will be reduced in a similar proportion.

5.2 Diffusion-controlled combustion process

After understanding the effects of advancing IVC on the in-cylinder conditions, a complete analysis on how these changes affect the overall combustion process has been carried out.

In direct injection Diesel engines, the combustion process is divided in three stages:

First revision of paper draft:

Effect of advancing the closing angle of the intake valves on diffusion-controlled combustion in a HD Diesel engine

auto-ignition delay time, premixed combustion stage and diffusion-controlled combustion stage. At full load, the two earlier stages are extremely short. Hence, this analysis has mainly focused on the diffusion-controlled combustion stage. But some comments on the behaviour of the auto-ignition delay time and the premixed combustion stage have been also introduced.

Figure 4 presents the actual injection rate and the RoHR, whereas Figure 5 shows the estimation for T_f and also the evolution of the in-cylinder Y_{O_2} . The auto-ignition delay time, τ , is defined in Figure 4 as the difference between the SoI and the SoC. Advancing IVC reduces p , ρ and T after the SoI, thus lengthening τ and retarding the SoC. Nevertheless, all τ values are between 0.065 and 0.1 ms and, as Figure 4 confirms, these differences of τ do not introduce noticeable modifications of the RoHR.

The premixed combustion stage is closely related to τ . Keeping the same injection rate profile, the longer τ increases the quantity of fuel injected before the SoC and the mass of fuel burnt during the premixed stage [18]. But as τ is extremely short at high load, the premixed combustion stage is practically inexistent and the final pollutant emissions and engine efficiency depends on the diffusion-controlled combustion stage characteristics.

Analysing the effect of advancing IVC on diffusion-controlled combustion, Figure 4 reveals an appreciable reduction in the RoHR once the combustion reaches the steady-state. Thus, advancing IVC deteriorates the diffusion-controlled combustion process.

This result is consistent with those obtained theoretically by Arrègle et al. [19, 20]. Starting from the turbulent gas jet theory in steady state and adapting it to Diesel-like

First revision of paper draft:

Effect of advancing the closing angle of the intake valves on diffusion-controlled combustion in a HD Diesel engine

spray conditions, they found that in diffusion-controlled combustion conditions the RoHR is directly related to the instantaneous fuel injection velocity, ρ and in-cylinder Y_{O_2} . It is also inversely dependent on nozzle hole diameter.

According to Figures 3 and 5, advancing IVC slows the diffusion-controlled combustion process due to the lower instantaneous ρ and faster reduction of in-cylinder Y_{O_2} . This decreases the air/fuel (and also oxygen/fuel) mixing process and finally explains the trends observed in the RoHR.

However, Figure 4 shows a slightly higher RoHR for the earliest IVC after the end of injection, during the late diffusion-controlled combustion phase. Advancing IVC results in a slower combustion process during the injection time interval, reducing the mass of fuel burnt before the end of injection. This increases the mass of fuel that should be burnt during the late diffusion-controlled combustion, when in-cylinder gas rapidly expands (reducing ρ) and combustion temperature sharply decreases. The higher quantity of fuel burnt in low flame temperature environment and extremely poor air/fuel mixing conditions should have consequences on final soot emissions.

Finally, the flame temperature during combustion, T_f , is also an important parameter closely related to pollutant emissions, especially NO_x formation. Figure 5 shows the estimated values for instantaneous T_f . This figure shows how advancing IVC results in lower T_f during the overall combustion process. T_f mainly depends on the initial temperature of the reactants at the start of combustion and, in this case, this temperature is reduced by about 25K for the earliest IVC. Thus, slight decrements in reactant initial temperatures cause noticeable reductions in T_f .

5.3 Pollutant emissions and engine efficiency

Figure 6 presents the most relevant instantaneous parameters concerning the injection and combustion processes for the different IVC cases: the in-cylinder Y_{O_2} , flame temperature T_f , apparent combustion speed and injection rate. Only the results for SoI +2 cad aTDC have been represented, but the behaviour is similar in the range of SoI analysed.

The apparent combustion speed has been calculated as the inverse of the apparent combustion time (ACT) [21, 22]. The injected fuel is sequentially divided in different chronological fuel parcels. After that, ACT is experimentally calculated for each package as the difference between its injection time and its combustion time. Thus, ACT is inversely related to air/fuel mixing speed.

In Figure 6, combustion progress has been normalised by the fraction of fuel burnt, rather than relating the process to the engine timescale. This particular representation is convenient for relating the trends observed in combustion process to those detected in pollutant emissions.

Figure 7 shows the pollutant emissions and engine efficiency results. According to this figure, advancing IVC reduces INO_x emissions. Figure 6 confirms how the main reason is the lower T_f during the combustion process, especially before the end of injection, where most of thermal NO_x forms [21].

On the negative side, Figure 7 shows that advancing IVC increases Isoot emissions. This trend can be explained also by analysing Figure 6. Due to the combustion deterioration discussed in the previous section, higher fraction of fuel should burn after

First revision of paper draft:

Effect of advancing the closing angle of the intake valves on diffusion-controlled combustion in a HD Diesel engine

the end of injection, during the late diffusion-controlled combustion. Focusing on this last part of combustion, Figure 6 shows how the apparent combustion speed, T_f and in-cylinder Y_{O_2} are clearly lower for earlier IVC. These worse conditions slow down the late soot oxidation process. On the light of these results, the main conclusion is that the increment in I_{soot} emissions is caused by the lower in-cylinder Y_{O_2} and T_f during the late diffusion-controlled combustion [22]. But it seems that the poor air/fuel mixing process and after the end of injection could also contribute to this increment in I_{soot} .

The same reasoning is also valid for ICO emissions. Figure 7 indicates an increment in this pollutant at earlier IVC. This is caused by combustion deterioration (lower ρ) and lack of oxygen (lower in-cylinder Y_{O_2} and A/F). IHC emissions are slightly affected by advancing IVC. The extremely low IHC emissions observed in Figure 7 are consistent with that expected at high load, where spray/wall impingement is avoided and the premixed combustion phase is almost negligible.

Figure 7 shows how advancing IVC results in a significant reduction in η_i , increasing i_{sfc} . The engine efficiency decreases basically due to the important changes in the $p-V$ diagram introduced by the lower CR_{eff} and deteriorated diffusion-controlled combustion.

Finally, the results of pollutant emissions and engine efficiency attained by advancing IVC have been compared to those obtained by retarding the SoI. This comparison has been based on the trade-off plots shown in Figure 8.

In terms of INO_x emissions, similar results were achieved with both strategies. However, in low INO_x conditions, advanced IVC strategies produced higher I_{soot} and ICO emission levels. The key difference between both strategies is ρ . Starting from the

First revision of paper draft:

Effect of advancing the closing angle of the intake valves on diffusion-controlled combustion in a HD Diesel engine

same reference point, advancing the IVC ρ is lower during the overall combustion process than in the case of retarding SoI, but especially after the end of injection. This deteriorates the diffusion-controlled combustion and the final result is an important deterioration in CO and soot oxidation processes during the late diffusion-controlled combustion. Finally, both strategies have been observed to noticeably increase *isfc*.

The results obtained increasing EGR from the nominal conditions have been included in Figure 8. The trade-off confirms how increasing EGR is the best strategy for reducing INO_x emissions up to very low levels without worsening engine performance, despite the higher *Isoot* and CO emissions.

6 Conclusions

A detailed investigation on the potential of advancing IVC for pollutant control at three different SoI has been carried out in a HD Diesel engine operating at high load and low engine speed. This work focused on in-cylinder gas thermodynamic conditions (including instantaneous oxygen mass concentration), injection-combustion processes, exhaust emissions and engine efficiency. The most relevant conclusions are:

- The direct consequences of advancing IVC are the reduction in the effective compression ratio of the engine and also in the total intake mass flow rate. These two effects introduce important modifications in the thermodynamic properties of the in-cylinder gas during the closed cycle. Temperature, pressure and density decrease during the compression stroke and combustion takes place in different environmental conditions.
- The in-cylinder gas pressure and density are more sensitive to the effective

First revision of paper draft:

Effect of advancing the closing angle of the intake valves on diffusion-controlled combustion in a HD Diesel engine

compression ratio than temperature. At the end of compression stroke, density and pressure are both reduced about 21.5%. Whereas temperature decreased only by 2.3%, in the range analysed.

- Changes in the combustion process are basically caused by a large reduction in gas density, not by the lower gas temperature. At full load, the ignition delay and premixed combustion stages are always very short. The air/fuel mixing process deterioration during the diffusion-controlled combustion stage results in a slower combustion process.
- Earlier IVC reduces flame temperatures due to lower initial temperature before the start of injection. Thus, noticeable reduction in INO_x emissions is attained by advancing IVC. However, the main drawback is an increment in I_{soot} and ICO emissions because of lower flame temperature and oxygen mass concentration during the late diffusion-controlled combustion (after the end of injection), which slows down both CO and soot oxidation processes.
- At high load, advancing IVC significantly reduces the engine efficiency. This is the result of lower effective compression ratio and longer diffusion-controlled combustion process, which modifies the overall p - V diagram. As a consequence, fuel consumption increases.
- Increasing boost pressure until recovering the nominal A/F should avoid the most critical drawbacks observed when advancing IVC, which are the sharp increment in soot, CO emissions and fuel consumption. However, the settings of present tests already simulate the boost conditions attained in a two stage turbocharged

First revision of paper draft:

Effect of advancing the closing angle of the intake valves on diffusion-controlled combustion in a HD Diesel engine

engine (4.6 bar). Thus, advancing IVC at full load without worsening the combustion process, exhaust emissions and engine performance requires a further development of the state-of-the-art turbocharging devices.

As an additional conclusion extracted from this research, it has been proved that the strategy based on retarding the start of injection provides better results than advancing IVC in terms of INO_x -Isoot trade-off, whereas the results in fuel consumption are comparable. From these results, the best compromise between pollutant reduction and engine performance is attained by increasing EGR strategy. Nevertheless, advancing IVC has shown its potential for NO_x emissions control.

Finally, authors want to mention that the conclusions of this investigation can be universalized if two conditions are accomplished: The boost pressure should be kept constant (isolated effect of advancing IVC) and the combustion process must be basically controlled by air/fuel mixing processes (conventional diffusion-controlled combustion). Due to these restrictions, the effect of advancing IVC at low engine loads has to be separately investigated. At low-load conditions the combustion process shifts towards a highly premixed combustion when advancing IVC. Thus, the effects on combustion process, exhaust emissions and engine performance could differ significantly from those explained in this paper.

Acknowledgments

This investigation has been carried out within Integrated Project GREEN of the EU's 6th Framework Programme for Research and Technological Development.

First revision of paper draft:

Effect of advancing the closing angle of the intake valves on diffusion-controlled combustion in a HD Diesel engine

References

- [1] J.B. Heywood, *Internal Combustion Engine Fundamentals*, McGraw-Hill, New York, 1988.
- [2] P.F. Flynn, R.P. Durrett, G.L. Hunter, A.O. zur Loye, O.C. Akinyemi, J.E. Dec and C.K. Westbrook, Diesel combustion: An integrated view combining laser diagnostics, chemical kinetics, and empirical validation, SAE Paper 1999-01-0509, 1999.
- [3] K. Epping, S. Aceves, R. Bechtold and J.E. Dec, The Potential of HCCI Combustion for High Efficiency and Low Emissions, SAE Paper 2002-01-1923, 2002.
- [4] T.J. Jacobs and D.N. Assanis, The attainment of premixed compression ignition low-temperature combustion in a compression ignition direct injection engine, *Proceedings of the Combustion Institute* 31 (2) (2007) 2913-2920.
- [5] R.H. Stanglmaier and C.E. Roberts, Homogeneous charge compression ignition (HCCI): Benefits, compromises, and future engine applications, SAE Paper 1999-01-3682, 1999.
- [6] F. Millo, F. Mallamo, G. Ganio Mego, The Potential of Dual Stage Turbocharging and Miller Cycle for HD Diesel Engines, SAE Paper 2005-01-0221, 2001.
- [7] J.H. Tuttle, Controlling engine load by means of early intake-valve closing, SAE Paper 820408, 1982.
- [8] D.J. Cleary and G. Silvas, Unthrottled Engine Operation with Variable Intake Valve Lift, Duration, and Timing, SAE Paper 2007-01-1282, 2007.
- [9] H. Steber, G. Weisser, H. U. Hörler and K. Boulouchos. Reduction of NO_x Emissions of D.I. Diesel Engines by Application of the Miller-System: An Experimental and Numerical Investigation, SAE Paper 960844, 1996.
- [10] Y. Wang, S. Zeng, J. Huang, Y. He, X. Huang, L. Lin and S. Li. Experimental investigation of applying Miller cycle to reduce NO_x emission from diesel engine, *Proceedings of the Institute of Mechanical Engineers, Part A: J Power and Energy* 219 (A8) (2005) 631-638.
- [11] R. Christian, F. Knopf, A. Jasmek and W. Schindler, A New Method for the Filter Smoke Number Measurement with Improved Sensitivity (in German), *MTZ* 54 (1993) 16-22.
- [12] W. Bosch, Fuel rate indicator is a new instrument for display of the characteristics of individual injection, SAE Paper 660749, 1966.
- [13] C.W. Turner, G.R. Babbitt, C.S. Balton, M.A. Ramaio and D.D. Giordano, Design

First revision of paper draft:

Effect of advancing the closing angle of the intake valves on diffusion-controlled combustion in a HD Diesel engine

and control of a two-stage electro-hydraulic valve actuation system, SAE Paper 2004-01-1265, 2004.

[14] B. Lombard and R. Le Forrestier, Advanced combustion and engine integration of a hydraulic valve actuation system (camless), SIA Variable Valve Actuation Conference Proceedings, 2006.

[15] M. Lapuerta, O. Armas and J.J. Hernández, Diagnostic of D.I. Diesel Combustion from In-Cylinder Pressure Signal by Estimation of Mean Thermodynamic Properties of the Gas, Applied Thermal Engineering 19 (5) (1999) 513–529.

[16] F. Payri, S. Molina, J. Martín and O. Armas, Influence of measurement errors and estimated parameters on combustion diagnosis, Applied Thermal Engineering 26 (2-3) (2006) 226–236.

[17] R.J.B. Way, Methods for determination of composition and thermodynamic properties of combustion products for internal combustion engine calculations, Proceedings of the Institution of Mechanical Engineers, 190 (60) 686–697.

[18] A.C. Alkidas, On the Premixed Combustion in a Direct-injection Diesel Engine, Journal of Engineering for Gas Turbines and Power 109 (1987) 187-192.

[19] J. Arrègle, J.J. López, J.M. García and C. Fenollosa, Development of a zero-dimensional Diesel combustion model. Part 1: Analysis of the quasi-steady diffusion combustion phase, Applied Thermal Engineering 23 (11) (2003) 1301–1317.

[20] J. Arrègle, J.J. López, J.M. García and C. Fenollosa, Development of a zero-dimensional Diesel combustion model: Part 2: Analysis of the transient initial and final diffusion combustion phases. Applied Thermal Engineering 23 (11) (2003) 1319–1331.

[21] Y. Kitamura, A. Mohammadi, T. Ishiyama and M. Shioji, Fundamental Investigation of NO_x Formation in Diesel Combustion Under Supercharged and EGR Conditions, SAE Paper 2005-01-0364, 2005.

[22] N. Ladommatos, H. Song and H. Zhao, Measurements and predictions of diesel soot oxidation rates, Proceedings of the Institute of Mechanical Engineers, Part D: J Automobile Engineering 216 (8) (2002) 677-689.

First revision of paper draft:

Effect of advancing the closing angle of the intake valves on diffusion-controlled combustion in a HD Diesel engine

Nomenclature

$\Delta isfc$	Variation of indicated specific fuel consumption (in %)
η_i	Indicated efficiency (in %)
η_v	Volumetric efficiency
ρ	In-cylinder density (in kg/m ³)
ρ_{TDC}	In-cylinder density at top dead centre (in kg/m ³)
τ	Auto-ignition delay time (in ms)
ACT	Apparent combustion time (in ms)
A/F	Fresh Air/Fuel ratio
aTDC	after Top Dead Centre
cad	Crank Angle Degrees
CR_{eff}	Volumetric Effective Compression Ratio
EGR	Exhaust Gas Recirculation
IHC	Unburnt Hydrocarbon Index (in g/kg fuel)
HD	Heavy Duty
ICO	Carbon Monoxide Index (in g/kg fuel)
INO_x	Nitrogen Oxides Index (in g/kg fuel)
$isfc$	Indicated specific fuel consumption (in g/kWh)
Isoot	Soot Index (in g/kg fuel)
IVC	Intake Valve Closing angle
k	Polytropic exponent
m_{IVC}	Total trapped mass of fresh air plus recycled exhaust gases (in g)
m_f	Mass of fuel injected per cycle (in mg)
NO_x	Nitrogen Oxides
p	In-cylinder gas pressure (in bar)
p_{in}	Intake pressure (in bar)
p_{inj}	Injection pressure (in bar)
p_{TDC}	In-cylinder gas pressure at top dead centre (in bar)
RoHR	Rate of Heat Release (in J/cad)
SoC	Start of Combustion (in cad aTDC)
SoI	Start of Injection (in cad aTDC)
T	In-cylinder gas temperature (in K)
T_f	Adiabatic flame temperature (in K)
T_{IVC}	In-cylinder gas temperature at IVC (in K)
T_{TDC}	In-cylinder gas temperature at top dead centre (in K)
VVA	Variable Valve Actuation
Y_{O_2}	Oxygen mass concentration (in %)

First revision of paper draft:

Effect of advancing the closing angle of the intake valves on diffusion-controlled combustion in a HD Diesel engine

List of Figures

1. Single cylinder research engine and complete test cell scheme	19
2. Effect of early IVC on in-cylinder conditions	20
3. Effect of early IVC on in-cylinder pressure, temperature and density	21
4. Effect of early IVC and SoI on combustion process	22
5. Effect of early IVC and SoI on the adiabatic flame temperature and instantaneous Y_{O_2} .	23
6. Effect of early IVC on apparent combustion speed ($1/ACT$), adiabatic flame temperature and in-cylinder Y_{O_2} referred to the fraction of fuel burnt.	24
7. Effect of early IVC and SoI on pollutant emissions and engine efficiency	25
8. Comparison between advancing IVC and retarding SoI strategies	26

First revision of paper draft:

Effect of advancing the closing angle of the intake valves on diffusion-controlled combustion in a HD Diesel engine

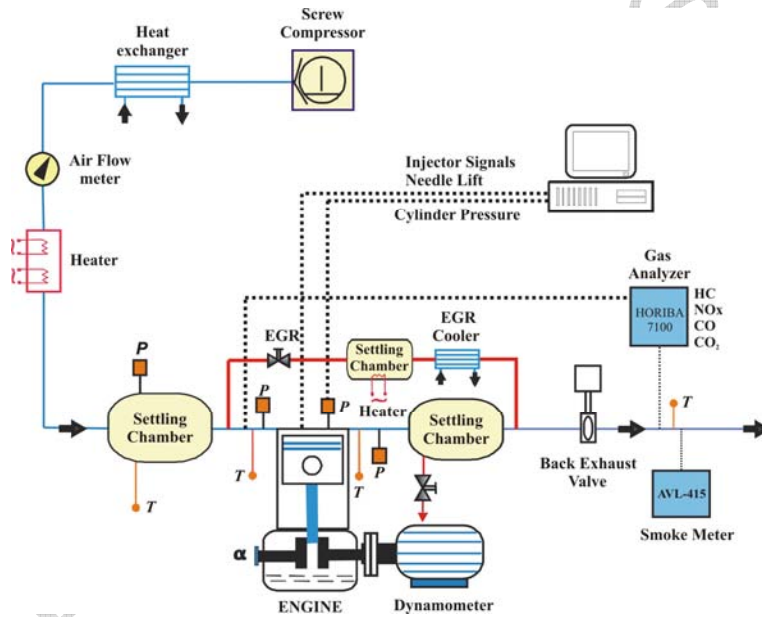

Figure 1. Single cylinder research engine and complete test cell scheme

First revision of paper draft:

Effect of advancing the closing angle of the intake valves on diffusion-controlled combustion in a HD Diesel engine

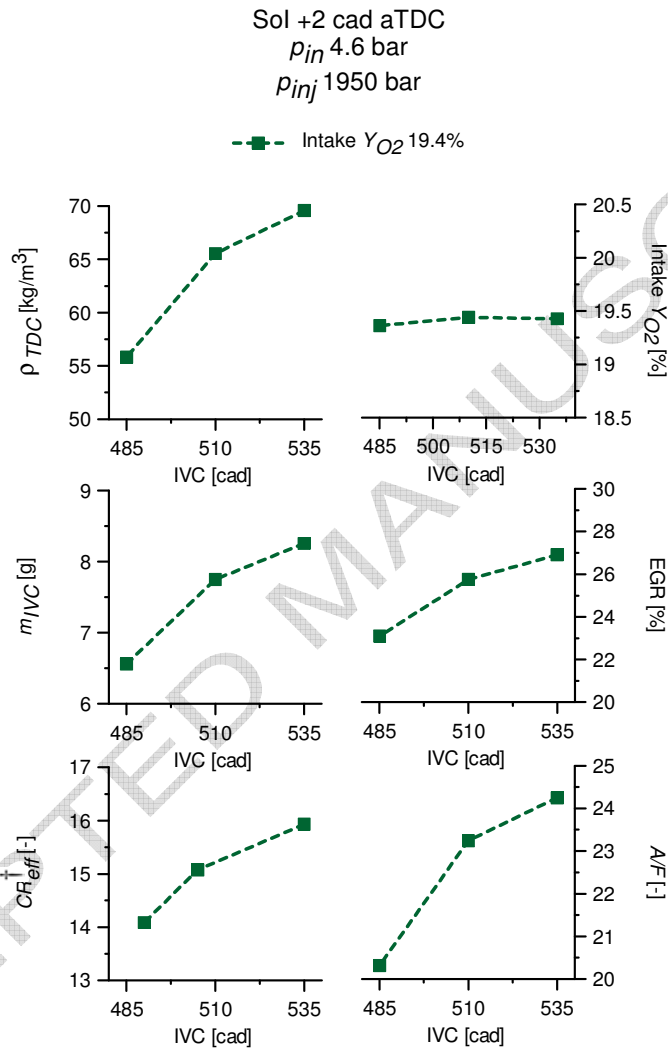

Figure 2. Effect of early IVC on in-cylinder conditions. [†]The CR_{eff} has been calculated at the nominal IVC, when the intake valve lift is 1 mm.

First revision of paper draft:

Effect of advancing the closing angle of the intake valves on diffusion-controlled combustion in a HD Diesel engine

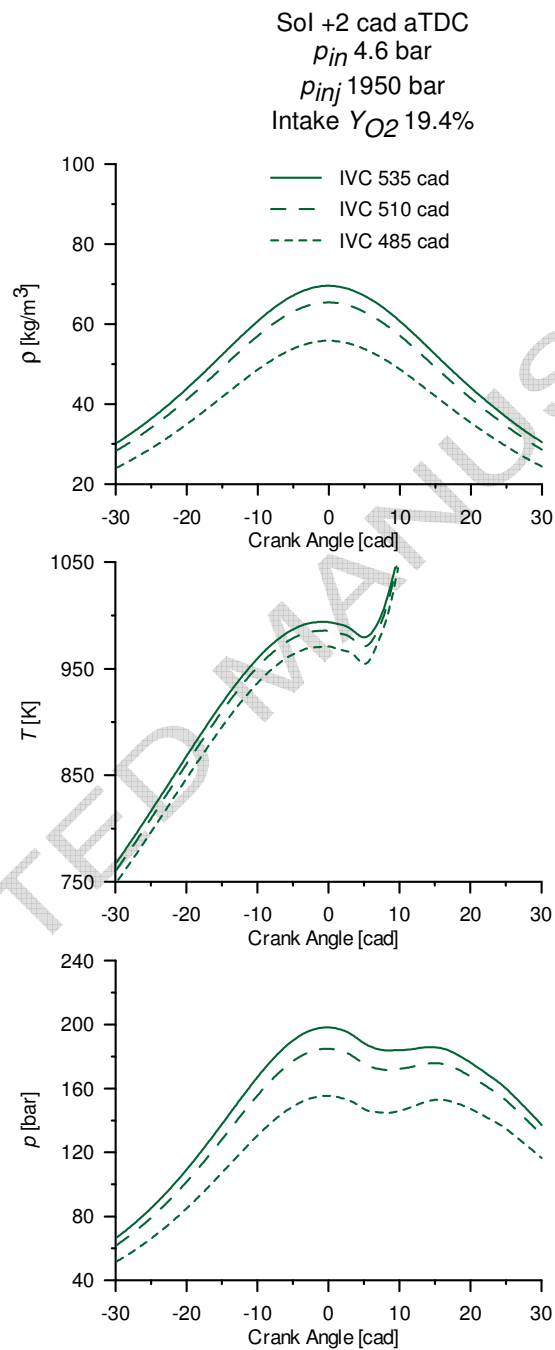

Figure 3. Effect of early IVC on in-cylinder pressure, temperature and density.

First revision of paper draft:

Effect of advancing the closing angle of the intake valves on diffusion-controlled combustion in a HD Diesel engine

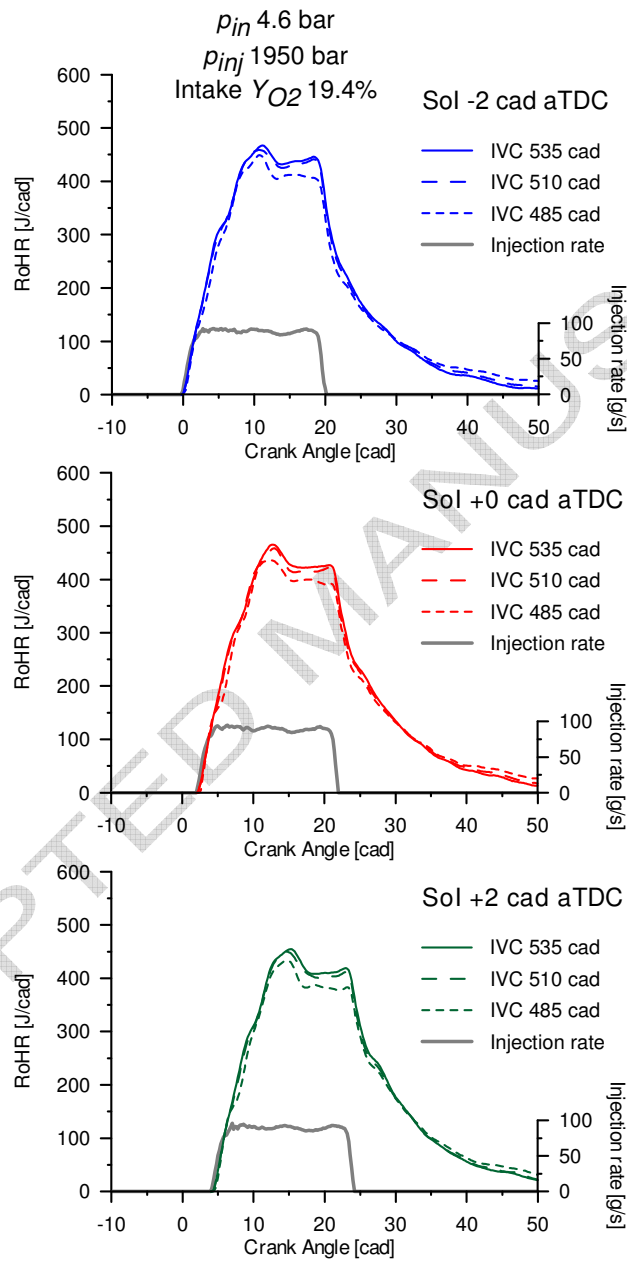

Figure 4. Effect of early IVC and SoI on combustion process.

First revision of paper draft:

Effect of advancing the closing angle of the intake valves on diffusion-controlled combustion in a HD Diesel engine

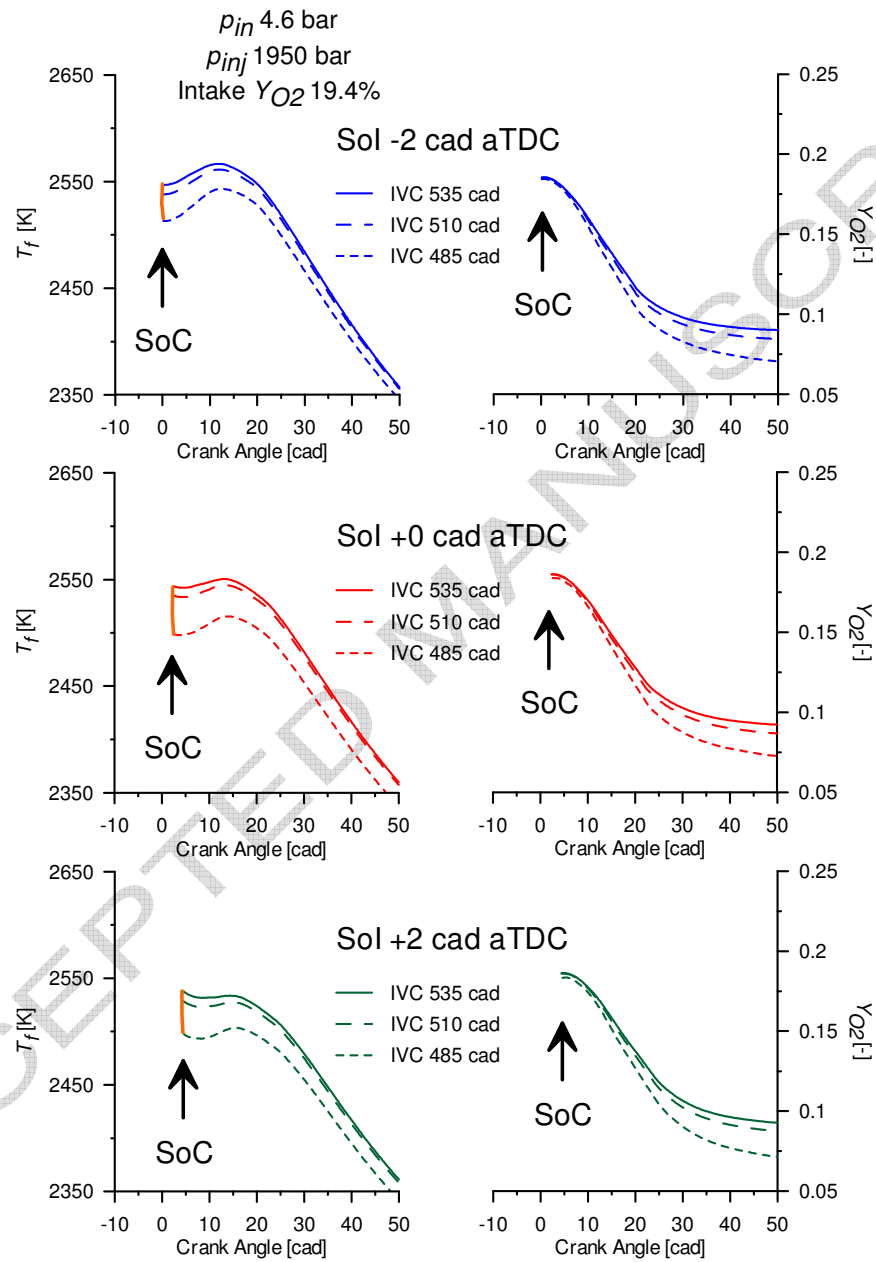

Figure 5. Effect of early IVC and SoI on the adiabatic flame temperature and instantaneous Y_{O_2} .

First revision of paper draft:

Effect of advancing the closing angle of the intake valves on diffusion-controlled combustion in a HD Diesel engine

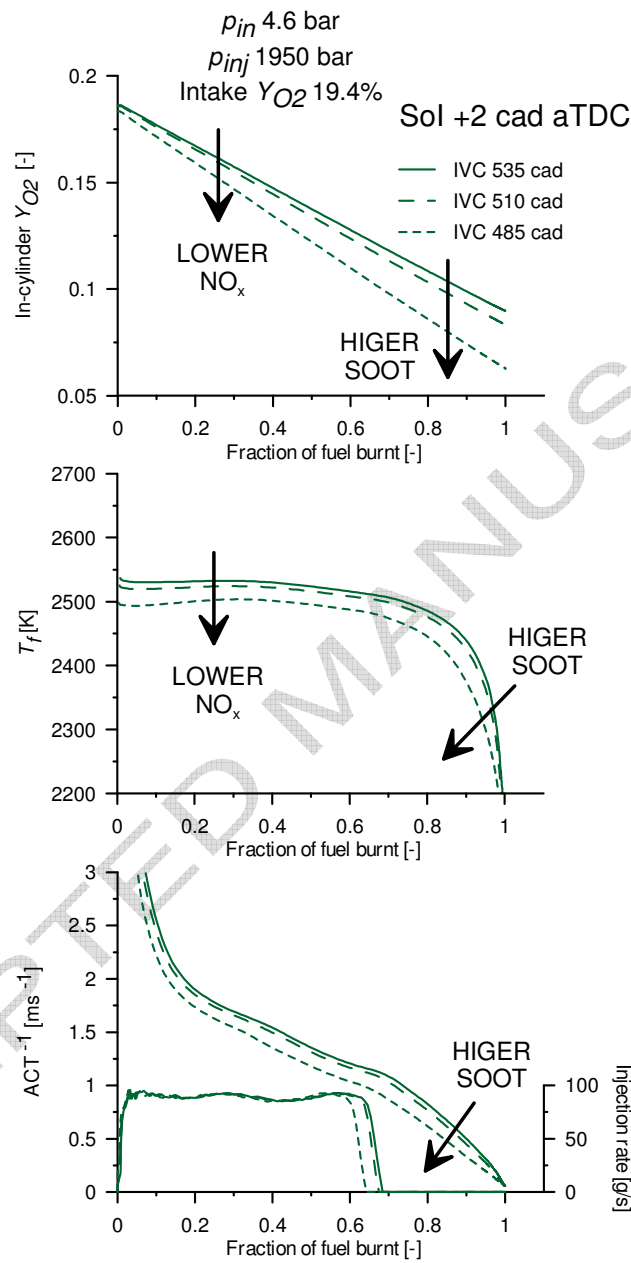

Figure 6. Effect of early IVC on apparent combustion speed (ACT^{-1}), adiabatic flame temperature and in-cylinder Y_{O_2} referred to the fraction of fuel burnt.

First revision of paper draft:

Effect of advancing the closing angle of the intake valves on diffusion-controlled combustion in a HD Diesel engine

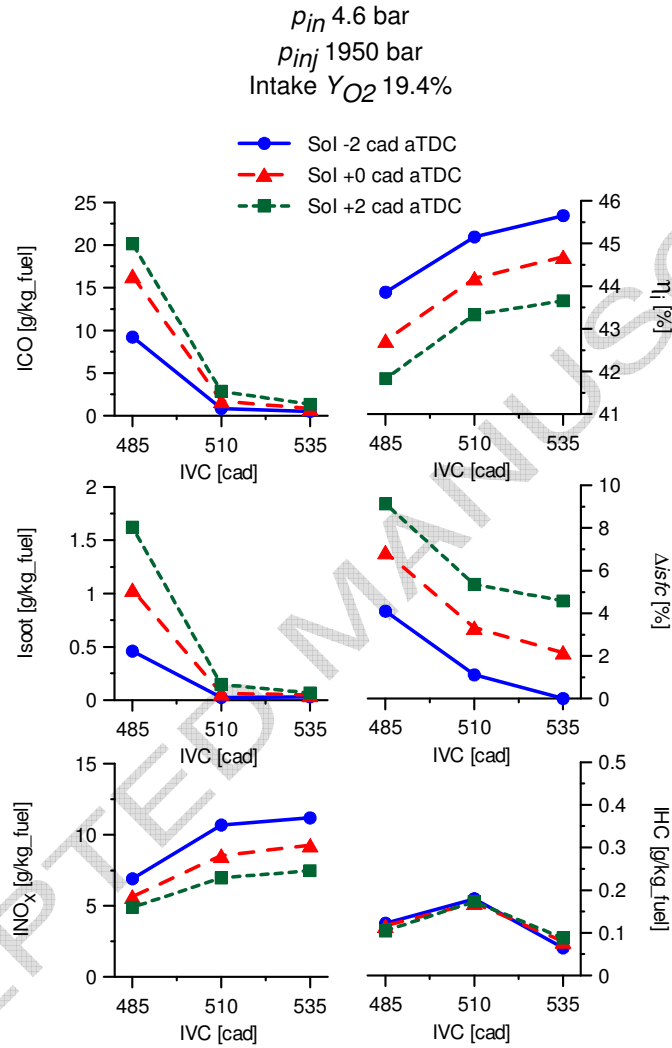

Figure 7. Effect of early IVC and SoI on pollutant emissions and engine efficiency.

First revision of paper draft:

Effect of advancing the closing angle of the intake valves on diffusion-controlled combustion in a HD Diesel engine

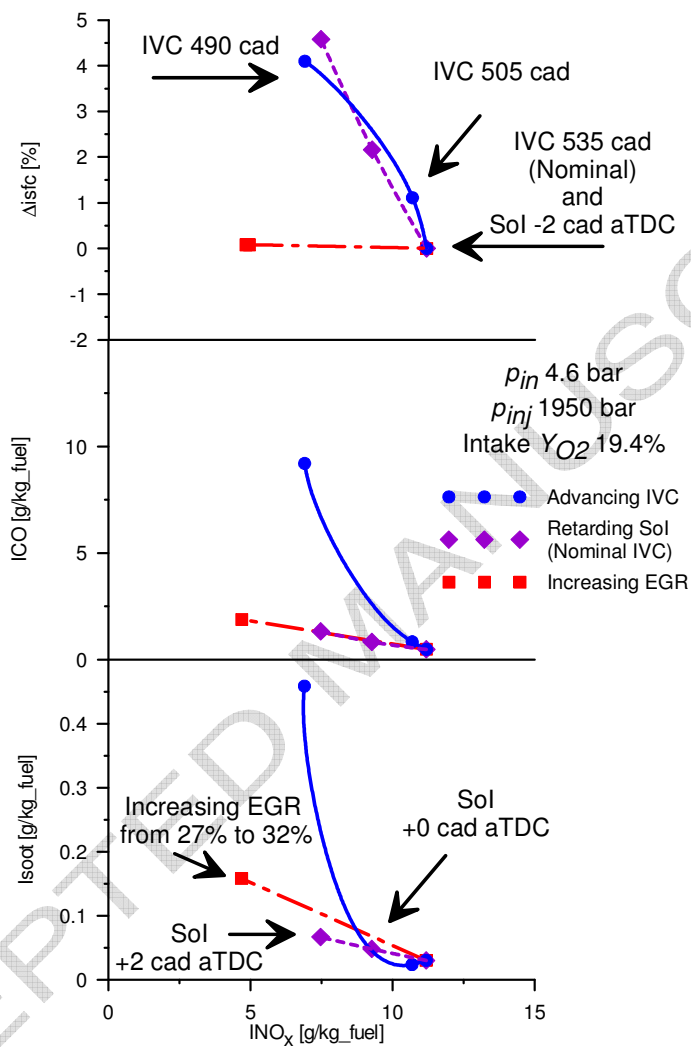

Figure 8. Comparison between advancing IVC, retarding Sol and increasing EGR strategies.

First revision of paper draft:

Effect of advancing the closing angle of the intake valves on diffusion-controlled combustion in a HD Diesel engine

List of Tables

- | | |
|---|----|
| 1. Single cylinder research engine specifications | 28 |
| 2. Main test settings | 29 |

ACCEPTED MANUSCRIPT

First revision of paper draft:

Effect of advancing the closing angle of the intake valves on diffusion-controlled combustion in a HD Diesel engine

Displacement	1806 cm ³
Bore x Stroke	12.3 cm x 15.2 cm
Nominal CR	16:1
Nominal MSN	0.3
Max cylinder pressure	250 bar
Injection system type	Common-rail + Pressure amplifier
Injection nozzle	6 holes x $\varnothing_{\text{hole}}$ 0.214 mm 140° included angle
VVA system type	Fully flexible electro-hydraulic system

Table 1. Single cylinder research engine specifications

First revision of paper draft:

Effect of advancing the closing angle of the intake valves on diffusion-controlled combustion in a HD Diesel engine

Speed [rpm]	SoI [cad aTDC]	p_{inj} [bar]	m_f [mg]	p_{in} [bar]	$Y_{O_2}^*$ [%]	EGR [%]	IVC [cad]
1200	-2	1950	232.3	4.600	19.4	27.0 [†]	535
						25.7	510
						23.1	485
	+0					27.0 [†]	535
						25.7	510
						23.1	485
	+2					27.0 [†]	535
						25.7	510
						23.1	485

Table 2. Main test settings. [†]These are the values for the EGR ratio at nominal IVC.
*Oxygen concentration in the intake gas.