



HAL
open science

A new damage index to monitor the range of the penetration process in thick laminates

Giovanni Belingardi, Maria Pia Cavatorta, Davide Salvatore Paolino

► **To cite this version:**

Giovanni Belingardi, Maria Pia Cavatorta, Davide Salvatore Paolino. A new damage index to monitor the range of the penetration process in thick laminates. *Composites Science and Technology*, 2010, 68 (13), pp.2646. 10.1016/j.compscitech.2008.04.029 . hal-00607151

HAL Id: hal-00607151

<https://hal.science/hal-00607151>

Submitted on 8 Jul 2011

HAL is a multi-disciplinary open access archive for the deposit and dissemination of scientific research documents, whether they are published or not. The documents may come from teaching and research institutions in France or abroad, or from public or private research centers.

L'archive ouverte pluridisciplinaire **HAL**, est destinée au dépôt et à la diffusion de documents scientifiques de niveau recherche, publiés ou non, émanant des établissements d'enseignement et de recherche français ou étrangers, des laboratoires publics ou privés.

Accepted Manuscript

A new damage index to monitor the range of the penetration process in thick laminates

Giovanni Belingardi, Maria Pia Cavatorta, Davide Salvatore Paolino

PII: S0266-3538(08)00167-X
DOI: [10.1016/j.compscitech.2008.04.029](https://doi.org/10.1016/j.compscitech.2008.04.029)
Reference: CSTE 4057

To appear in: *Composites Science and Technology*

Received Date: 26 February 2008
Accepted Date: 11 April 2008

Please cite this article as: Belingardi, G., Cavatorta, M.P., Paolino, D.S., A new damage index to monitor the range of the penetration process in thick laminates, *Composites Science and Technology* (2008), doi: [10.1016/j.compscitech.2008.04.029](https://doi.org/10.1016/j.compscitech.2008.04.029)

This is a PDF file of an unedited manuscript that has been accepted for publication. As a service to our customers we are providing this early version of the manuscript. The manuscript will undergo copyediting, typesetting, and review of the resulting proof before it is published in its final form. Please note that during the production process errors may be discovered which could affect the content, and all legal disclaimers that apply to the journal pertain.



A NEW DAMAGE INDEX TO MONITOR THE RANGE OF THE PENETRATION PROCESS IN THICK LAMINATES

Giovanni Belingardi, Maria Pia Cavatorta*, Davide Salvatore Paolino

Mechanical Engineering Department – Politecnico di Torino
Corso Duca degli Abruzzi, 24 – 10129 Torino (Italy)

ABSTRACT

A damage variable (damage degree DD) representing the ratio between the absorbed energy and the impact energy was introduced in 1998 by Belingardi and Vadori to assess damage accumulation caused by low-velocity impacts. More recently, repeated impact tests carried out on thick laminates pointed out the significance and extent of the penetration process in thick laminates, which the DD is unable to monitor as, by definition, it reaches the value of one at penetration to remain unchanged over the entire penetration process. In the present paper, a new damage variable (damage index DI) is proposed to overcome shortcomings of the DD with respect to thick laminates. By introducing the displacement of the impactor into the definition of the DI, the depth of the penetration process is taken into account. Normalization by the displacement of the quasi-static perforation test allows for a non-dimensional damage variable which is shown to reach the value of one at perforation. Validity of the approach is proven against impact data obtained for different fibre-matrix architectures and laminate thickness. Results show that the DI can effectively differentiate between penetration and perforation thresholds, increasing monotonically within the range of the penetration process. In particular, the DI is shown to increase linearly with the impact energy up to penetration and to rise quite abruptly within the range of the penetration process. Results for repeated impact tests prove that at first the DI increases quite linearly impact after impact, owing to a steady accumulation of damage. A few impacts before penetration a sudden rise in the DI value points out a change in the rate of damage accumulation.

KEYWORDS:

Low velocity impact, damage accumulation, single and repeated impact tests, polymer matrix composites.

INTRODUCTION

Energy balances have often being used to evaluate the level of damage accumulation during impact events. In [1-3] Belingardi and Vadori introduced the *Damage Degree* (DD) defined as the ratio between the absorbed energy and the impact energy. The impact energy E_i is the kinetic energy of the impactor right before contact takes place and it is indeed the energy introduced into the specimen. The energy absorbed by the specimen E_a can be calculated from the load-displacement curve as the area surrounded by the curve in case of closed load-displacement curves (impact event

* Corresponding author. Fax number: +39.011.5646999. e-mail address: maria.cavatorta@polito.it

with rebound) or the area bounded by the load-displacement curve up to a constant level of force and the horizontal axis in case of open load-displacement curves (impact event with no rebound). Based on the energy viewpoint, penetration should take place the first time the absorbed energy reaches the level of impact energy. Therefore the DD is below one for impact events with rebound while reaches the value of one in case the impactor is stopped with no rebound and specimen penetration is achieved. In [2,3], it was shown that the relationship between the DD and the impact energy increases monotonically until saturation and a fairly good data interpolation was achieved by a linear regression curve [3]. A *saturation energy* level E_{sa} was defined as the impact energy at which the DD regression curve reaches the value of one. This energy threshold is of practical and theoretical interest since it defines the maximum energy level the laminate can dissipate by means of internal damage mechanisms only [1].

The linear relationship between the DD and the impact energy found in [3] agrees well with the second-order relationship proposed by Mian and Quaresimin [4] between the *absorption coefficient* (defined as the ratio between the absorbed energy E_a and the penetration energy E_p) and the *intensity coefficient* (defined as the ratio between the impact energy E_i and the penetration energy E_p). The *penetration energy* E_p is defined in accordance to reference [5] as the absorbed energy depurated by the contribution of friction and it is conventionally measured in perforation tests as the energy level at which the force signal flattens [5]. As it will be explained hereafter, for thick laminates the defined penetration energy E_p would rather be an approximate measurement of the perforation energy. However, in the case of thin laminates as the ones examined in [4,5], conditions of laminate penetration and perforation basically coincide.

Going back to the original definition proposed in [4]:

$$\frac{E_a}{E_p} = \left(\frac{E_i}{E_p} \right)^2 \quad (1)$$

an empirical *master curve* can be defined, which is shown to hold true for different lay-ups and different composite materials.

A second-order polynomial regression curve was also proposed by Liu [6,7] to describe the absorbed energy vs. impact energy curve (named by Liu the *energy profile*) up to penetration:

$$E_a = aE_i^2 + bE_i + c \quad (2)$$

Depending on the laminate under study, the linear term and the constant c can be smaller than the quadratic term so that equation (2) can be simplified as:

$$E_a \cong aE_i^2 \quad (3)$$

It is worthwhile noticing that by rewriting equation (1) in the form:

$$E_a = \frac{1}{E_p} E_i^2 \quad (4)$$

the linear coefficient a of Liu's regression curve acquires a specific meaning, being the inverse of the laminate penetration energy.

As pointed out in [6,7], while a single energy threshold is generally sufficient to define the impact characteristics of thin laminates, for thick laminates two different threshold values are to be defined: the *penetration threshold* P_n and the *perforation threshold* P_r .

The penetration threshold is identified at the first time the absorbed energy reaches the level of impact energy and it is therefore conceptually the same as the saturation energy. For impact energies above the penetration threshold, the impactor moves deeper into the laminate. Once the impact energy is high enough, perforation eventually takes place. Between the penetration and perforation thresholds, there exists a range, named by Liu "*the range of the penetration process*", in which the impact energy and the absorbed energy are equal to each other but which represent different stages of the penetration process with the impactor moving deeper and deeper into the specimen as the impact energy increases.

Damage variables based on the energy viewpoint are obviously unable to catch the different stages of the penetration process as they reach a value of one at the penetration threshold to remain unchanged over the entire penetration process. Penetration and perforation thresholds increase with thickness, so does the range of the penetration process. In other words, while for thin laminates the difference between the penetration and the perforation thresholds can be negligible, for thick laminates the same can become quite significant. For cross-ply glass-epoxy composite laminates, Liu [7] found that the ratio between the penetration threshold P_n and the perforation threshold P_r is a function of the laminate thickness t :

$$\frac{P_n}{P_r} = 0.8t^{0.0247} \approx 0.8 \quad (5)$$

Equation (5) indicates that for the investigated glass/epoxy laminates, the penetration threshold is about 80% of the perforation threshold. In case of 3-mm thin laminates, the range of penetration process ($P_r - P_n$) is less than 2 J. For 6-mm laminates, a difference of 15 J is found, while for 12-mm thick laminates, ($P_r - P_n$) exceeds 100 J and by far can not be neglected.

As more and more composites have gained ground in automotive, nautical and military applications, fibre-reinforced polymer matrix composites are also utilised in thick-laminate form. One important aspect differentiating thick from thin laminates is indeed the extent and significance of the

penetration process up to laminate perforation. In the present paper a new formulation of the DD introduced by Belingardi and Vadori is presented which seems to effectively differentiate between the penetration and the perforation thresholds. Experimental data obtained on laminates of different fibre-resin architectures and thickness are reported to test validity of the approach.

EXPERIMENTAL

Experimental impact tests were performed according to ASTM 3029 standard [8] using an instrumented free-fall drop dart testing machine. The impactor has a total mass of 20 kg; its head is hemispherical with a radius of 10 mm. Stainless steel was chosen for its high hardness and resistance to corrosion. The maximum falling height of the testing machine is 2 m, which corresponds to a maximum impact energy of 392 J. The drop-weight apparatus was equipped with a motorized lifting track. The collected data were stored after each impact and the impactor was returned to its original starting height. Using this technique, the chosen impact velocity was consistently obtained in successive impacts. Because, the target holder was rigidly attached to the frame of the testing device, the tup struck the specimen each time at the same location. By means of a piezoelectric load cell, force-time curves were acquired and, with a double integration, force-displacement curves were obtained. By additional integration, deformation energy-displacement curves were plotted. Initial conditions were given with the time axis having its origin at the time of impact. At time $t=0$, the dart coordinate is zero and its initial velocity can be obtained by the well known relationship:

$$v_0 = \sqrt{2g\Delta h} \quad (6)$$

where Δh is defined as the height loss of the centre of mass of the dart with respect to the reference surface [2,3]. The impact velocity was also measured by an optoelectronic device.

Square specimen panels, with 100 mm edge, were clamped with a 76.2 mm inner diameter, and fixed to a rigid base to prevent slippage of the specimen (Figure 1). The clamping system was designed to provide an uniform pressure all over the clamping area.

Prior to impact tests, a series of quasi-static perforation tests were performed to get information on the laminate strength characteristics. Specimens were tested using a servo-hydraulic machine with maximum loading capacity of 100 kN. The hydraulic actuator was electronically controlled in order to perform constant velocity tests. Signals of the force applied by the actuator and of the actuator displacement were acquired in time with an appropriate sampling rate.

Table 1 reports main characteristics of the laminates used in the study. Together with test data obtained by the authors, test results by Liu [7] and Sutherland & Guedes Soares [9] were also employed. Unfortunately, no other literature data could be taken into consideration since not all the information required in the analysis were available from the papers.

FROM THE DAMAGE DEGREE TO THE DAMAGE INDEX

The idea of an improved definition for the DD came up during a series of repeated impact tests on 12.31 mm thick laminates for nautical applications [10]. Four impact energies were considered (25 J, 49 J, 98 J and 147 J corresponding to impact velocities of 1.5 m/s, 2.2 m/s, 3.1 m/s and 3.8 m/s) and a minimum of four specimens for any given energy were subject to forty repeated impacts or up to perforation. The two higher impact energies lead to perforation, while the lower two did not. However, apart from the 25 J tests, the value of the DD at the first impact was around 0.90 regardless of the impact energy (Figure 2). Moreover, the non-monotonic behaviour of the curves was difficult to explain considering that the DD is a measure of the level of damage induced in the laminate and as such should grow with the impact number.

Another aspect of concern was linked to the fact that a DD of one was not always associated to complete perforation of the laminate. As underlined by Liu [6,7], a significant range for the penetration process was to be expected considering the laminate thickness; however, the DD was not able to make any distinction among impact energies above the penetration threshold since by definition it saturates to one [1-3].

$$DD = \begin{cases} \frac{E_a}{E_i}, \text{ up to the penetration threshold} \\ \equiv 1, \text{ after the penetration threshold} \end{cases}$$

The idea of a new damage variable, named hereafter the damage index (DI), aroused considering that in the range of the penetration process, the impactor moves deeper and deeper into the specimen as the impact energy increases. It was therefore decided to introduce into the damage variable a measure of how far the impactor had penetrated into the laminate:

$$DI = DD \frac{s_{MAX}}{s_{QS}} \quad (7)$$

The value s_{MAX} in equation (7) refers to the displacement value recorded at the instant when the force approximately reaches a constant value, in case of impact tests that cause specimen perforation; while it corresponds to the maximum displacement recorded during the test below the perforation threshold.

In order to make the DI a non-dimensional quantity, the displacement s_{MAX} was normalised by the corresponding displacement s_{QS} measured in quasi-static perforation tests (Figure 3). The choice of normalising by s_{QS} was taken so to leave apart possible strain-rate effects on the s_{MAX} values. Indeed, it is not possible to assume a priori that the value of s_{MAX} would be equal when measured in perforation tests performed at different impact velocities. Therefore, the choice of the quasi-static perforation test is a way of defining an absolute reference test. It is in any case worthwhile saying that results presented in [11] suggest that, even in the presence of significant strain-rate effects on the delamination threshold load (DTL), the displacement value measured at DTL remains almost constant. Indeed, at least for the laminates investigated in the study, the s_{MAX} of perforation tests was constant regardless of the impact velocity and equal to the s_{QS} value.

DI vs. DD: ANALYSIS OF IMPACT DATA

As already discussed, results obtained on 12.31 mm thick glass/vinylester laminates showed that the DD value was not able to effectively tell apart impact tests performed at different impact energies, at least with reference to the first impact.

Figure 4 plots the DD and DI data against the impact energy. As it can be observed, the DI increases for increasing impact energies. Data scatter is very limited and a remarkable correlation exists with a linear regression curve.

The overall data referring to the series of repeated impacts tests are shown in Figure 5. As it can be observed, the DI data, not only show a different value at first impact for different impact energies, but, given the impact energy, increase monotonically with the impact number owing to the process of damage accumulation.

As with the DD, the DI remains basically constant for the 25 J tests while it slowly increases impact after impact for the 49 J tests, denoting a slow but steady accumulation of damage. For both perforation tests (98 J and 147 J tests), the DI shows an initial steady increase followed by an abrupt growth up to perforation. Figures 6-7 are close ups of the 147 J and 98 J repeated impact tests, respectively. They clearly display that the initial portion of steady damage accumulation corresponds to a linear growth of the DI. In Figure 6 it can be observed how the DI effectively differentiates between penetration and perforation, while the DD reaches the value of one as soon as penetration occurs. Another advantage of the DI over the DD can be noticed in Figure 7. Again the repeated impact test was carried out up to laminate perforation. Starting from the 18th impact, the DI visibly shows that a change in the rate of damage accumulation is taking place helping foreseeing laminate penetration. In this respect, the DD appears less sensitive.

When considering Figure 4, it is worthwhile noticing that the fitting curves of both the DD and DI do not intersect the origin of the axes, meaning that a non-zero damage is present at zero impact energy. To investigate the initial portion of the DD/DI-impact energy curves, additional tests were performed at very low impact energies. Results are reported in Figure 8. As expected, the previously evaluated linear regression (Figure 4) does not hold true for very low impact energies. Nevertheless, while for the DD the initial step rise is quite abrupt and extrapolation of the linear fit to impact energies close to zero leads to high positive DD values which cannot represent the damage induced by impacts at almost null energies; for the DI the initial step rise is rather small so that the extrapolated DI values are still very close to zero.

In the attempt to prove the potentiality of the approach also in case of single impact tests up to laminate perforation, the open literature was reviewed in search of suitable impact data obtained on thick laminates. Unfortunately, almost all reviewed papers provide impact and absorbed energies but make no reference to displacement data. The only viable literature sources were [7] and [9]. In [7] examination of the load-displacement curves revealed that, in impact tests where perforation occurred, the displacement value at which the force signal becomes constant is about the same regardless of the impact energy. The curves also show that no significant strain-rate effect exists. Not having access to the quasi-static perforation curve, it was assumed that the quasi-static displacement s_{QS} was equal to the s_{MAX} at perforation, similarly to what observed in thick glass/vinylester laminates [10]. Figure 9 depicts impact data for a 6.25 mm thick glass-epoxy laminate [7] analysed in terms of DD and DI. As it can be observed, the DI vs. impact energy curve is linear up to the penetration threshold. Also the DI effectively distinguishes between the penetration threshold and the perforation threshold, while the DD stays at the value of one over the entire range of the penetration process.

In [9] a rather complete set of impact data including impact energy, absorbed energy and maximum displacement is reported in the Appendix for the seven glass/polyester laminates under study. Unfortunately for most tested laminates, impact energies are below the penetration threshold. Moreover, definition of the maximum displacement is explicitly given only in case of impact tests with rebound for which the datum is said to refer to the displacement corresponding to the maximum force. When penetration is achieved, given data are difficult to interpret as the reported values are extremely variable and, in some cases, more than four times the displacement value just before penetration. Only for a 10-ply chopped-strand-mat, about 10.50 mm thick, data appear to be quite consistent and were used in the analysis. Again the quasi-static displacement s_{QS} was assumed to be equal to the displacement s_{MAX} at perforation. Figure 10 reports the impact data analysed in

terms of DI and DD. The main interest for data shown in Figure 10 lies in the fact that impact tests were performed with impactors of mass ranging from 2.853 to 10.853 kg, i.e. data referring to a given impact energy were obtained at different impact velocities. As it can be seen, data scattering is rather limited for both the DD and DI curve showing that, at least in the analysed case, the damage variables are not strain-rate sensitive.

Provided that the range of the penetration process is less significant for thin laminates, it was decided to prove the DI against the DD in the case of thin laminates for which the DD was proven to work quite satisfactory.

Figure 11 reports the DI and the DD values for impact tests performed on 4.50 mm glass-epoxy laminates [12]. The range of the penetration process is only a few Joules, however the DI once again permits to differentiate between the two energy thresholds, signalling laminate penetration with an abrupt growth of the DI and reaching the value of one at perforation. The linear regression curve up to laminate penetration is again characterised by an excellent correlation coefficient.

Figures 12-13 plot the DD and the DI for the thin carbon-epoxy laminates originally used to test the DD concept [3]. In case of very thin laminates, plots of the DD against the impact energy are quite satisfactory; however, Figures 13-14 demonstrate that the correlation coefficient for the DI is always higher than the one associated to the DD. Once again, while the DD stays at a value of one over the entire range of the penetration process, the DI reaches the value of one only at perforation pointing out the onset of the penetration process with a sudden abrupt growth.

Slopes of the DI vs. impact energy plots of Figures 12-13 are reported in Table 2. It can be observed that, given the lay-up, the slope (i.e. the rate of accumulated damage) decreases with the number of layers, while, given the number of layers, the slope is lower in the case of the $[0/90]_n$ lay-up. A slower accumulation of damage well correlates with a higher penetration threshold [3].

CONCLUSIONS

A new damage variable, the damage index DI, has been presented in the paper aimed at overcoming shortcomings of the damage degree (DD) in case of thick composite laminates. In particular, displacement of the impactor during the test has been introduced into the DI definition so that the depth of the penetration process within the laminate can be correctly investigated; whereas the DD, by definition, stays at a value of one over the entire penetration process. Normalization by the displacement of the quasi-static perforation test allows for a non-dimensional damage variable which is shown to reach the value of one at laminate perforation.

Analysis of single impacts on different fibre-matrix architectures and laminate thickness have pointed out suitability of the DI to differentiate between penetration and perforation thresholds. Below penetration, the DI increases linearly with the impact energy while it undergoes an abrupt rise within the range of the penetration process. When used to elaborate impact data on thin laminates, the DI is in good agreement with results obtained for the DD. In any case, the correlation coefficient for the linear regression of the impact energy curve is higher for the DI than it is for the DD. Tests run at low impact energies pointed out that the linear regression does not hold true for very low impact energies. However, while for the DD the initial step rise is quite abrupt and extrapolation of the linear fit to impact energies close to zero leads to high positive DD values which cannot represent the damage induced by impacts at almost null energies; for the DI the initial step rise is rather small so that the extrapolated DI values are still very close to zero. When introduced to analyse data of repeated impact tests, the DI is shown to initially increase linearly impact after impact, owing to a steady accumulation of damage, to then grow quite abruptly a few impacts before penetration, signalling a change in the rate of damage accumulation.

REFERENCES

- [1] Belingardi, G., Grasso, F. and Vadori, R., 1998, "Energy absorption and damage degree in impact testing of composite materials", Proceedings XI ICEM (Int. Conf. Experimental Mechanics), Oxford (UK), pp. 279-285.
- [2] Belingardi, G., and Vadori, R., 2002, "Low velocity impact tests of laminate glass-fiber-epoxy matrix composite materials plates", International Journal of Impact Engineering, 27, pp. 213-229.
- [3] Belingardi, G. and Vadori, R., 2003, "Influence of the laminate thickness in low velocity impact behaviour of composite material plate". Composite Structures, 61, pp. 27-38.
- [4] Mian, S. and Quaresimin, M., 2006, "A model for the energy absorption capability of composite laminates", 8th Biennial ASME Conference on Engineering Systems Design and Analysis, July 4-7 2006. Paper Number: ESDA 2006-95788
- [5] Caprino, G., Lopresto V., Scarponi, C. and Briotti, G., 1999, "Influence of material thickness on the response of carbon-fabric/epoxy panels to low velocity impacts", Composite Science and Technology, 59, pp. 2279-2286.
- [6] Liu, D., Raju, B.B. and Dang, X., 1998, "Size effect on impact response of composite laminates". International Journal of Impact Engineering, 21, pp. 837-854.
- [7] Liu, D., 2004, "Characterization of impact properties and damage process of glass/epoxy composite laminates". J. Composite Materials, 38, pp. 1425-1442.
- [8] ASTM D3029 – "Standard Test Method for Impact Resistance of Rigid Plastic Sheeting or Parts by means of a Tup (Falling Weight)". American Society for Testing Materials (1982).
- [9] Sutherland, L.S. and Guedes Soares, C., 1999, "Effects of laminate thickness and reinforcement type on the impact behaviour of e-glass/polyester laminates", Composites Science and Technology, 59, pp.2243-2260.

- [10] Belingardi, G., Cavatorta, M.P. and Paolino, D.S., 2006, “Comparative response in repeated impact tests of hand lay-up and vacuum infusion glass reinforced composites”. 8th Biennial ASME Conference on Engineering Systems Design and Analysis, July 4-7 2006. Paper Number: ESDA 2006-95752.
- [11] Schoeppner, G.A. and Abrate, S., 2000, “Delamination threshold loads for low velocity impact on composite laminate”. *Composites: Part A*, 31(9), pp. 903-915.
- [12] Belingardi, G., Cavatorta, M.P. and Duella, R., 2003, “Material characterization of a composite-foam sandwich for the front structure of a high speed train”, *Composite Structures*, 61, pp. 13-25.

Table 1. Main characteristics of the laminates analysed in the paper

| Reference | Fibre /Matrix | Lay-up | Nominal Thickness [mm] |
|-----------|-----------------------------|--|------------------------|
| [10] | Glass/Vinylester +Polyester | [random/0 ₂ /90/random/90/0 ₂ /random] | 12.31 |
| [9] | Glass/Polyester | 10-ply chopped-strand-mat | ≈10.50 |
| [7] | Glass/Epoxy | [0/90/0/...] ₉ | 6.25 |
| [11] | Glass/Epoxy | [random/-45/+45/0 ₂] ₂ | 4.50 |
| [3] | Carbon/Epoxy | [0/90] ₄ | 0.35 |
| | | [0/90] ₈ | 0.75 |
| | | [0/90] ₁₆ | 1.55 |
| | | [0/60/-60] ₄ | 0.40 |
| | | [0/60/-60] ₈ | 0.85 |
| | | [0/60/-60] ₁₆ | 1.75 |

Table 2- Slope of the DI vs. impact energy curves (Figures 12-13)

| Slope of the DI-impact energy curve ($\times 10^4$) | | |
|---|-------------------------|---------------------|
| | [0/60/-60] _n | [0/90] _n |
| n=4 | 160 | 64 |
| n=8 | 46 | 19 |
| n=16 | 15 | 9 |

FIGURE CAPTIONS

Figure 1. Testing fixture for impact testing (dimensions are in mm).

Figure 2. DD vs. impact number. Series of repeated impact tests on glass/vinylester + polyester 12.31 mm laminates.

Figure 3. An example of quasi-static perforation tests and impact tests to perforation [11]. Definition of the displacement variables s_{MAX} and s_{QS} .

Figure 4. Value of the DD and DI at first impact vs. impact energy. Data for glass/vinylester + polyester 12.31 mm laminates.

Figure 5. A comparison between the DD and the DI for repeated impact tests on glass/vinylester + polyester 12.31 mm laminates.

Figure 6. The DD and DI parameters in repeated impact tests up to laminate perforation. Impact energy: 147 J.

Figure 7. The DD and DI parameters in repeated impact tests up to laminate perforation. Impact energy: 98 J

Figure 8. A close up of the DD and DI curves at very low impact energies. Data for glass/vinylester + polyester 12.31 mm laminates.

Figure 9. A comparison between the DD and the DI for impact tests on glass/epoxy 6.25 mm laminates [7].

Figure 10. DI and DD plotted against impact energy for 10.50 mm glass-polyester laminates [9]. The impacting mass varies from 2.853 to 10.853 kg.

Figure 11. A comparison between the DD and the DI for impact tests on glass/epoxy 4.50 mm laminates.

Figure 12. A comparison between the DD and the DI for impact tests on carbon/epoxy laminates. Lay-up: $[0/60/-60]_n$

Figure 13. A comparison between the DD and the DI for impact tests on carbon/epoxy laminates. Lay-up: $[0/90]_n$

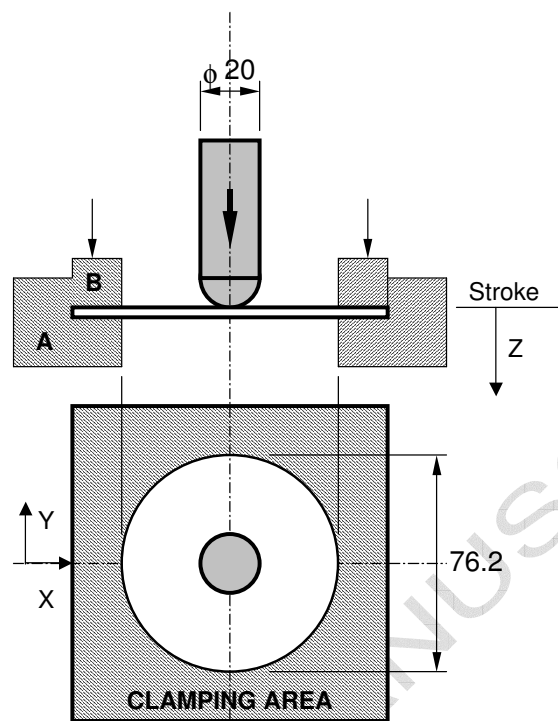

Figure 1. Testing fixture for impact testing (dimensions are in mm).

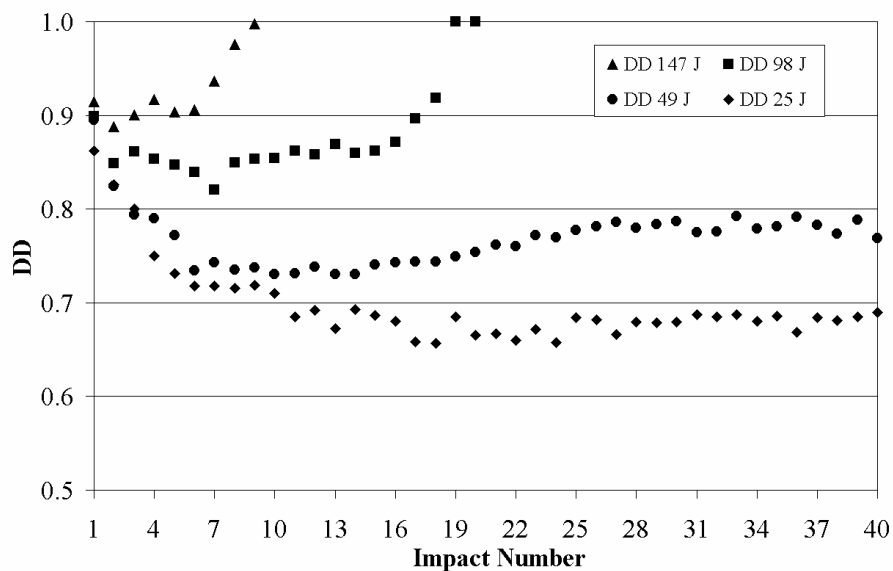

Figure 2. DD vs. impact number. Series of repeated impact tests on glass/vinylester + polyester 12.31 mm laminates.

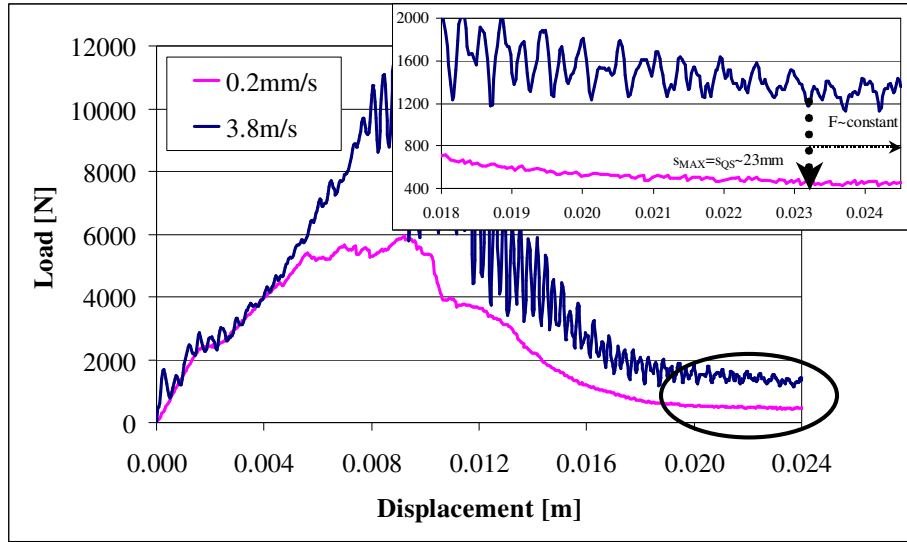

Figure 3. An example of quasi-static perforation tests and impact tests to perforation [11]. Definition of the displacement variables s_{MAX} and s_{QS} .

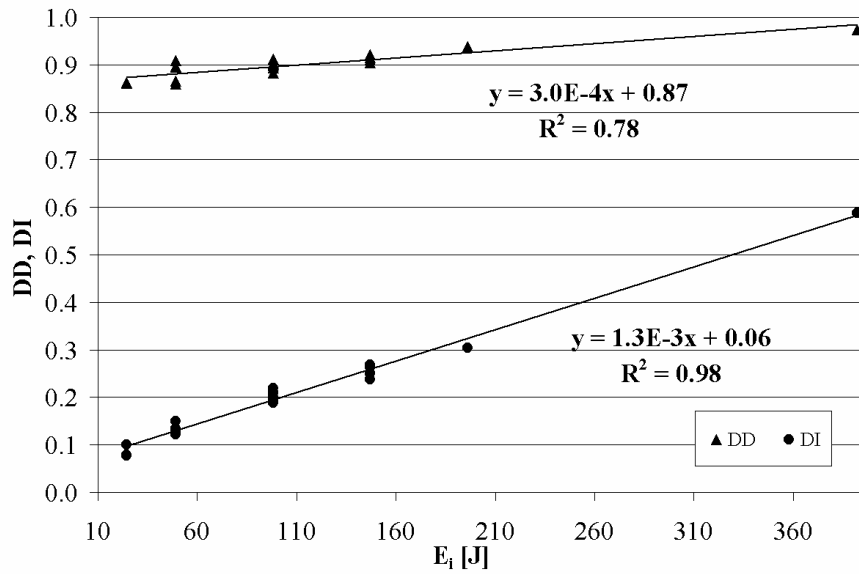

Figure 4. Value of the DD and DI at first impact vs. impact energy. Data for glass/vinylester + polyester 12.31 mm laminates.

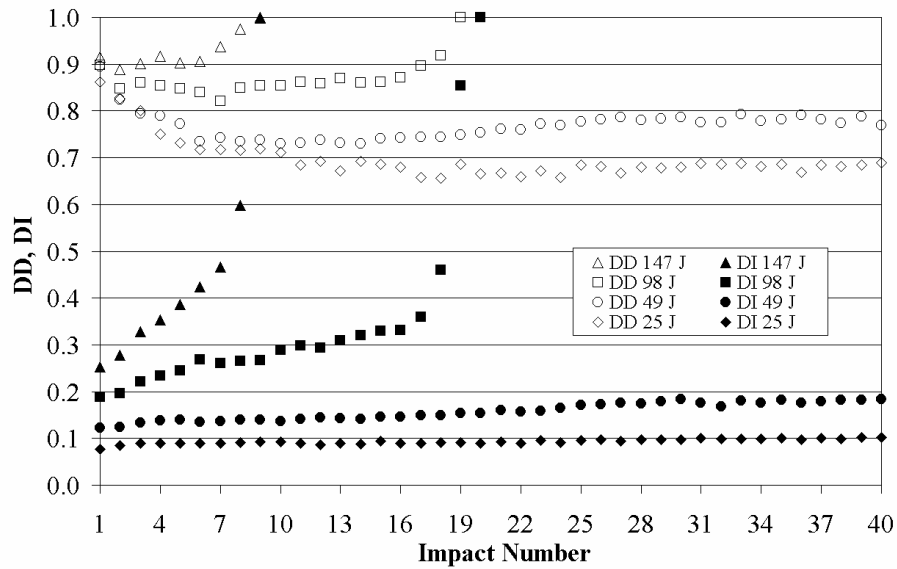

Figure 5. A comparison between the DD and the DI for repeated impact tests on glass/vinylester + polyester 12.31 mm laminates.

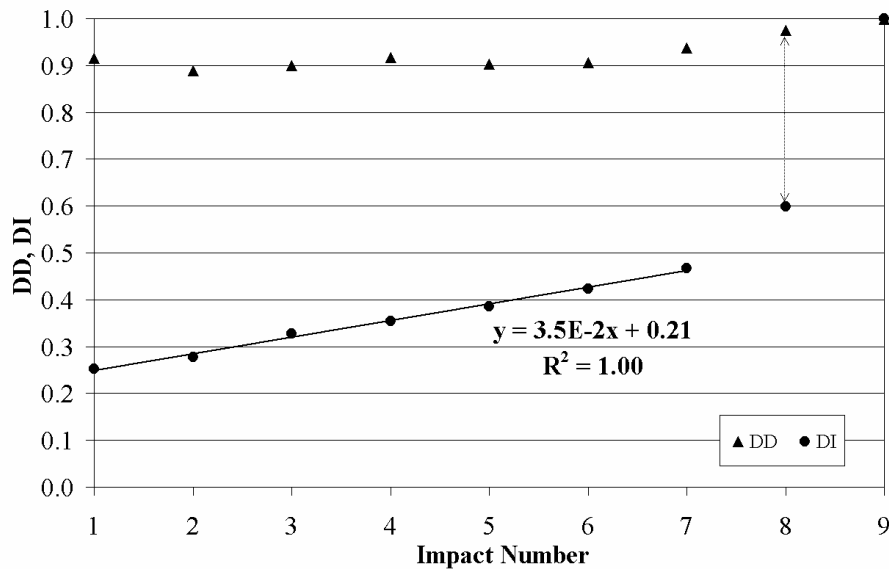

Figure 6. The DD and DI parameters in repeated impact tests up to laminate perforation. Impact energy: 147 J.

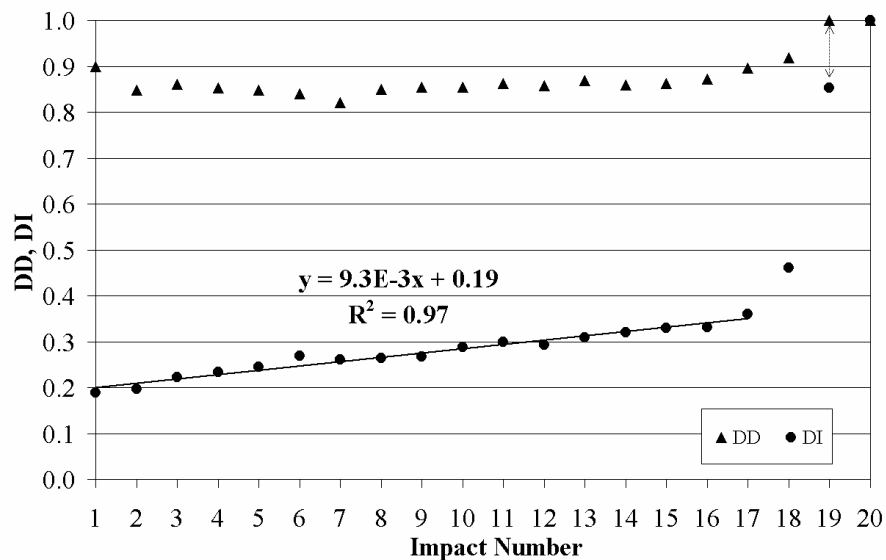

Figure 7. The DD and DI parameters in repeated impact tests up to laminate perforation. Impact energy: 98 J

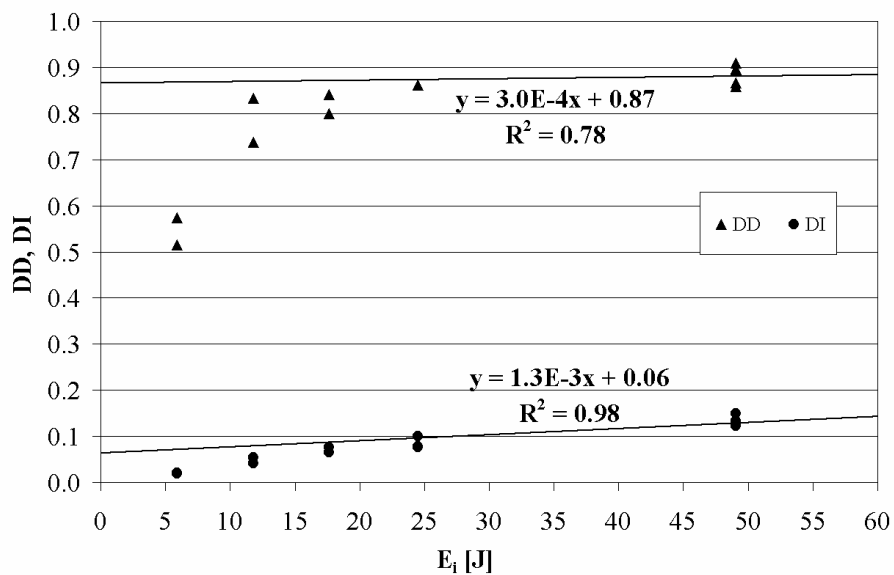

Figure 8. A close up of the DD and DI curves at very low impact energies. Data for glass/vinylester + polyester 12.31 mm laminates.

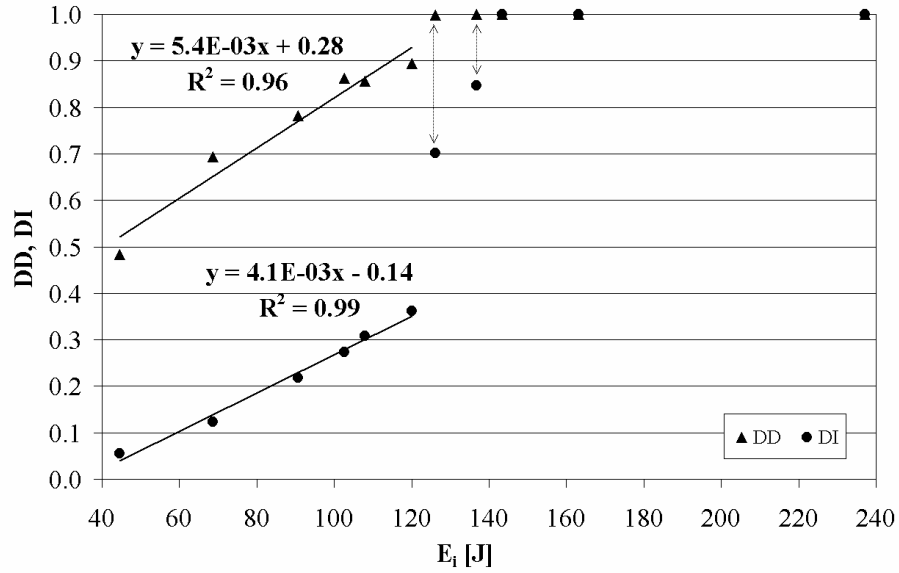

Figure 9. A comparison between the DD and the DI for impact tests on glass/epoxy 6.25 mm laminates [7].

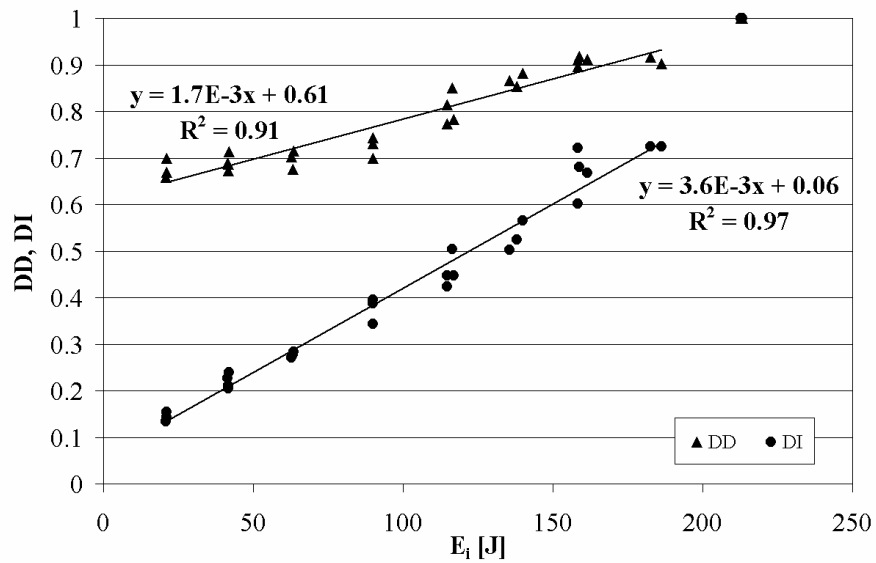

Figure 10. DI and DD plotted against impact energy for 10.50 mm glass-polyester laminates [9]. The impacting mass varies from 2.853 to 10.853 kg.

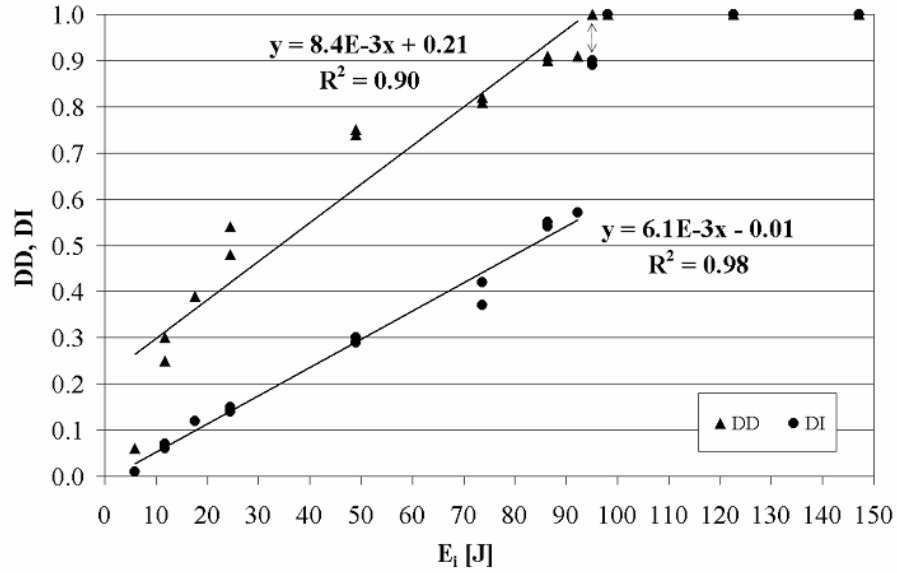

Figure 11. A comparison between the DD and the DI for impact tests on glass/epoxy 4.50 mm laminates.

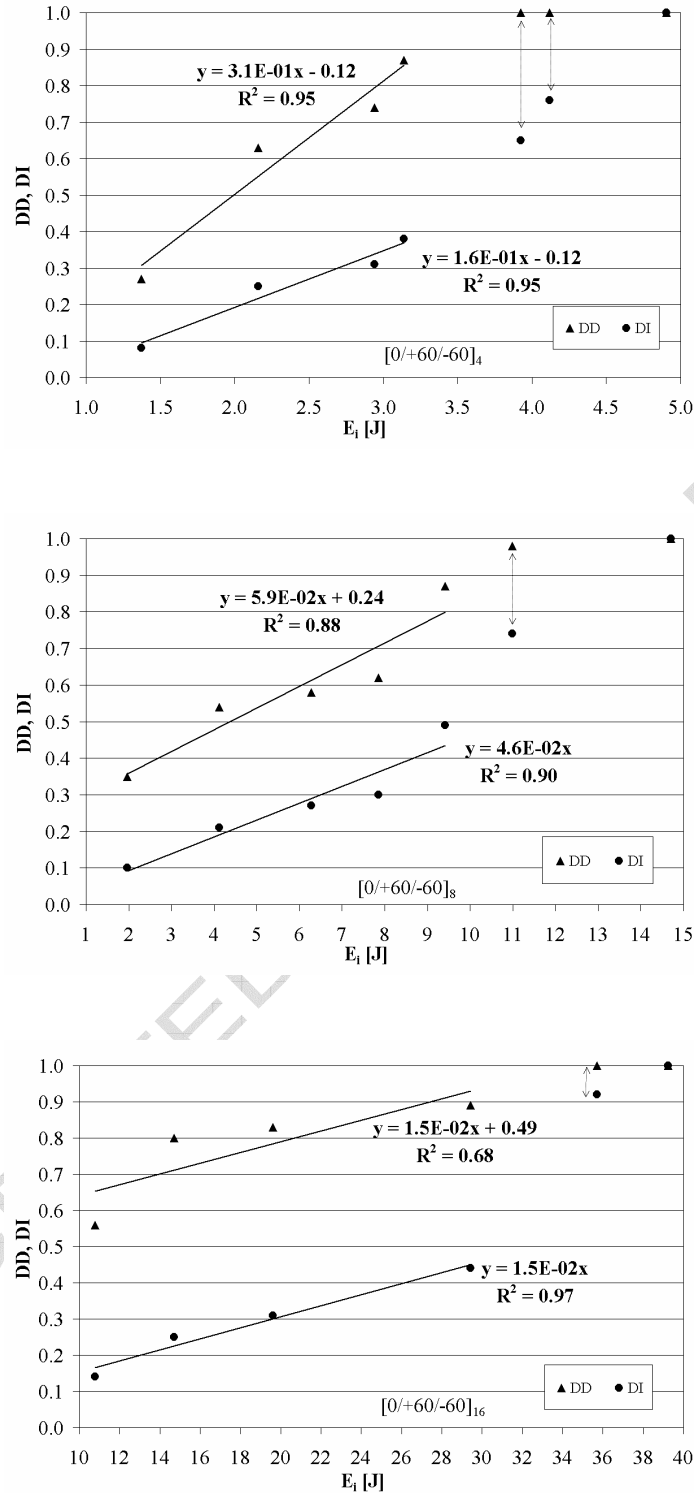

Figure 12. A comparison between the DD and the DI for impact tests on carbon/epoxy laminates. Lay-up: [0/+60/-60]_n

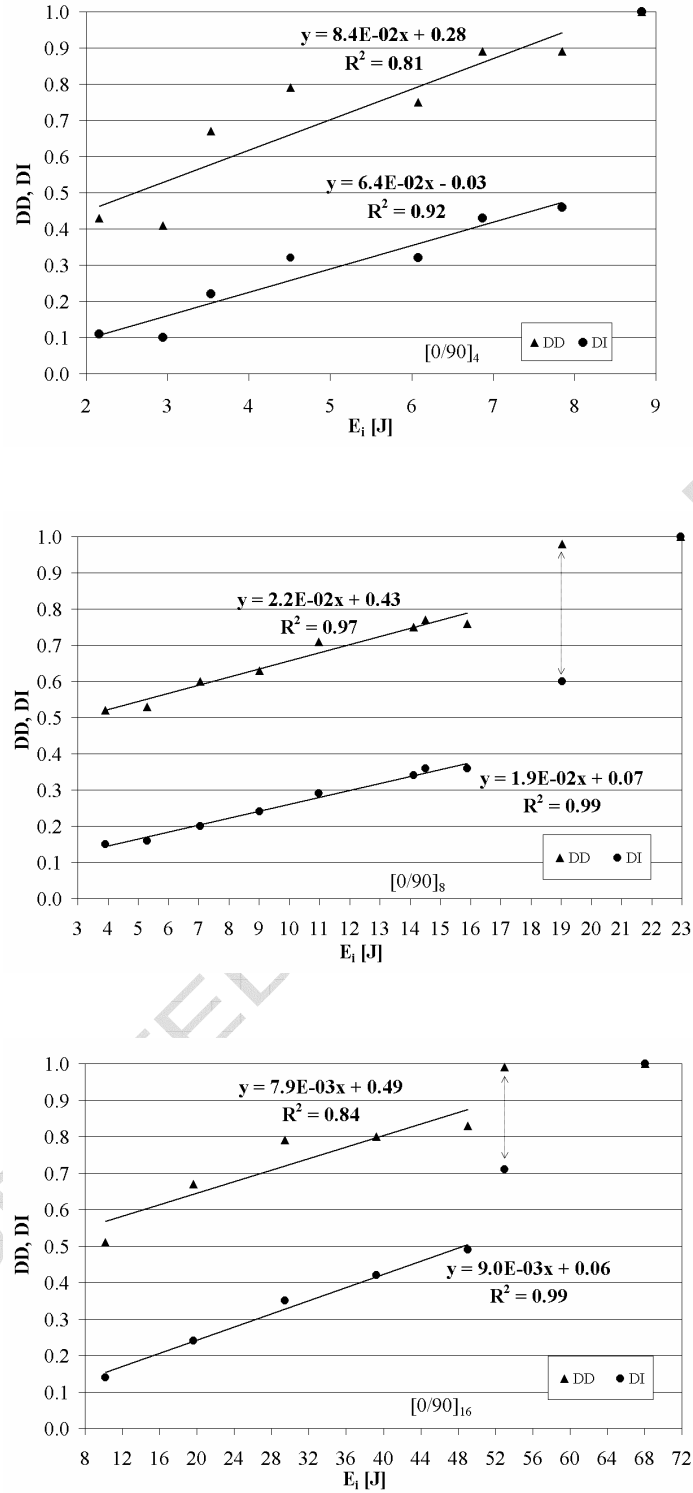

Figure 13. A comparison between the DD and the DI for impact tests on carbon/epoxy laminates. Lay-up: $[0/90]_n$