



HAL
open science

Study of an innovative gas-liquid contactor for CO₂ absorption

Elodie Chabanon, Chakib Bouallou, Jean-Christophe Remigy, Elsa Lasseuguette, Yaocihuatl Medina-Gonzalez, Eric Favre, P.T. Nguyen, D. Roizard

► **To cite this version:**

Elodie Chabanon, Chakib Bouallou, Jean-Christophe Remigy, Elsa Lasseuguette, Yaocihuatl Medina-Gonzalez, et al.. Study of an innovative gas-liquid contactor for CO₂ absorption. Elsevier. GHGT-10, Sep 2010, Amsterdam, Netherlands. Energy Procedia, 4, pp.1769-1776, 2011, 10.1016/j.egypro.2011.02.052 . hal-00606479

HAL Id: hal-00606479

<https://hal.science/hal-00606479v1>

Submitted on 3 Feb 2021

HAL is a multi-disciplinary open access archive for the deposit and dissemination of scientific research documents, whether they are published or not. The documents may come from teaching and research institutions in France or abroad, or from public or private research centers.

L'archive ouverte pluridisciplinaire **HAL**, est destinée au dépôt et à la diffusion de documents scientifiques de niveau recherche, publiés ou non, émanant des établissements d'enseignement et de recherche français ou étrangers, des laboratoires publics ou privés.



Distributed under a Creative Commons Attribution - NonCommercial - NoDerivatives 4.0 International License

GHGT-10

Study of an innovative gas-liquid contactor for CO₂ absorption

E. Chabanon^a, C. Bouallou^a, J.C Remigy^b, E. Lasseuguet^b, Y. Medina^b
E. Favre^c, P.T. Nguyen^c, D. Roizard^c

^aCentre Energétique et Procédés (CEP) MINES ParisTech, 60 boulevard Saint Michel 75006 Paris, France

^bLaboratoire de Génie Chimique (LGC) Université Paul Sabatier, 118 route de Narbonne 31062 Toulouse, France

^cLaboratoire Réactions et Génie des Procédés (LRGP UPR 3349-Nancy Université), ENSIC-BP 451, 1 rue Grandville, 54001 Nancy Cédex, France

Abstract

The absorption of CO₂ from a CO₂/N₂ mixture is investigated using a membrane gas absorption process. In order to avoid any wetting problem and maintain optimal the removal efficiency, composite membranes, with a porous support coated by a dense layer, are used. Two composite membranes are studied: Oxyplus[®] and a polypropylene (PP) porous fiber coated by poly(1-trimethylsilyl-1-propyne) (PTMSP). The influence of some parameters on the CO₂ removal efficiency is explored.

A lower removal efficiencies is obtained with a PP-PTMSP fiber compared with Oxyplus[®] because of a PTMSP layer thickness four times larger than the dense layer of Oxyplus[®] fibers. Indeed, this dense layer is the key parameter which controls the membrane resistance. Experiments achieved validate the resistance of the membrane to the wettability. Increasing the liquid flow raises the removal efficiency of at least 5 %. This one is higher than 90 %. In the Oxyplus[®] module case, similar removal efficiencies are obtained, around 99 %, with the blend of methyl-diethanolamine and triethylene tetramine (MDEA+TETA) and with monoethanolamine (MEA) for gas velocities lower than 0.84 m.s⁻¹. A 363 K regeneration temperature of liquid phase and 2 bar is sufficient to maintain a 90 % CO₂ removal efficiency.

© 2011 Published by Elsevier Ltd. Open access under [CC BY-NC-ND license](https://creativecommons.org/licenses/by-nc-nd/4.0/).

Keywords: Composite membrane, PTMSP dense layer, continuous CO₂ absorption-desorption cycles

1. Introduction

Reduction of greenhouse gas concentration in atmosphere, especially CO₂, is one of the great aims of the XXIth century. The capture is the most expensive step of the capture storage chain (CCS). And it has been the object of many projects developed during the last two decades. Thus, hollow fiber membrane contactors (HFMC) have been investigated as an alternative processes to

packed columns [1, 5]. Indeed, the HFMC interfacial area is easily known and remains constant. Thus, the process is easier to scale-up because it does not depend on the operating conditions such as the temperature or the flow rate. The HFMC is a compact process which should help to reduce both absorber and stripper units size by 65 % [11, 16]. The gas and the liquid phases are controlled independently. Thus, the operational flexibility is higher for the HFMC than the packed columns. Nevertheless, HFMC is not a selective process by itself [1-5], that is why it is combined with a chemical absorption in case of the postcombustion capture.

The liquid phase is generally an aqueous solution of alkanolamine, mainly MEA solutions. Thus, it is the liquid phase and especially reaction with CO₂ which is the driving force of the mass transfer. Moreover, the conventional microporous fibers are very sensitive to pores wetting by the liquid phase. The membrane wetting leads to a decrease of the removal efficiency [6-10]. This is why composite dense membranes have been investigated. They avoid the pore wetting by using a porous support coated by a dense layer which is totally impermeable to the liquid phase and does not react with it.

2. Experimental section

A commercial composite membrane, commercialized by Membrana (Oxyplus[®]), is used as reference. A dense outer layer in polymethylpentene (PMP) coats a support of polypropylene (PP). Results obtained are compared with a composite membrane developed by LGC and LRGP. A support of PP is coated by a dense outer layer of poly(1-trimethylsilyl-1-propyne) (PTMSP), (PP-PTMSP). The support is a microporous hollow fiber also commercialized by Membrana (Oxyphan[®]). Hollow fiber modules have been prepared at the LGC at a laboratory scale. Table 1 presents the geometrical characteristics of membrane modules which are studied.

Table 1: Data on hollow fiber modules

	Oxyplus [®] 210	Oxyplus [®] 290	Oxyplus [®] 463	Oxyplus [®] 579	PP- PTMSP
Number of fibers	210	290	463	579	210
Shell i.d. (m)	0.013	0.013	0.013	0.013	0.013
Fiber o.d (μm)	380	380	380	380	385
Fiber thickness (μm)	90	90	90	90	52.5
Layer thickness (μm)	~0.5	~0.5	~0.5	~0.5	2.5
Support thickness (μm)	~86.5	~86.5	~86.5	~86.5	50
Fiber Length (m)	0.240	0.205	0.143	0.120	0.286
Interfacial area (m ² /m ³)	0.75	1.21	2.77	4.12	0.64
Packing fraction, φ	0.18	0.25	0.40	0.50	0.18

The experimental set-up is shown in Fig. 1 [14]. The dense layer keeps the non-wetted condition necessary to have the optimal removal efficiency [11]. The gas stream is introduced in the lumen side of fibers [12, 13] in counter-current flow to have the optimal removal efficiency [6, 11]. CO₂ transfers from CO₂/N₂ mixture through the membrane into the liquid in the shell side where it is absorbed. The CO₂ concentration is measured at the outlet of the module by gas chromatography (GC). A by-pass system is used to measure the CO₂ concentration inlet of the module. The loaded solvent is regenerated in a boiler and used for a new absorption-desorption cycle. 30 min are required to reach the steady state of the liquid phase before absorption starts. The CO₂ absorption follows during 50 min. Three types of liquid solvents are considered: an aqueous solution of a primary alkanolamine: MEA (20 and 30 %wt.), an aqueous solution of a tertiary alkanolamine:

MDEA (25 and 50 %wt.) and an aqueous blend developed by CEP: MDEA (18 and 25 %wt.) with a primary alkanolamine: TETA (6 %wt.) (Fig. 2).

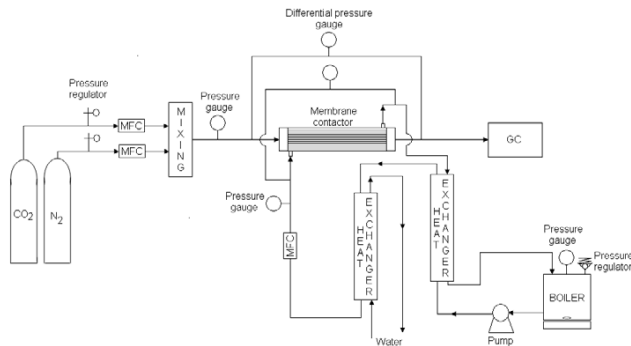

Fig. 1: Experimental set-up

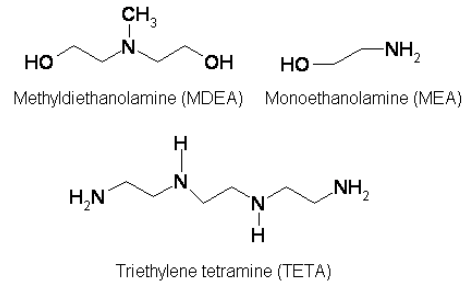

Fig. 2: Chemical solvents structures

3. Results and discussions

A series of experiments are conducted to study CO₂ removal for postcombustion capture. The influence of some parameters is investigated: gas and liquid velocities, solvent concentration, module packing fraction, layer type or the regeneration temperature. The removal efficiency is expressed as:

$$\eta = \frac{(C_{CO_2}^{in} - C_{CO_2}^{out})}{C_{CO_2}^{in}} \times 100$$

Where $C_{CO_2}^{in}$ and $C_{CO_2}^{out}$ are the CO₂ concentration in the gas stream inlet and outlet of the hollow fiber membrane contactor.

3.1. Influence of velocities

The influence of the velocity and the amine mass fraction are presented in Figs. 3 and 4. A 5% CO₂ volume fraction in feed gas is applied.

Results obtained with a 20 %wt. MEA (Fig. 3.) solution show a significant decrease of the removal efficiency at a low liquid velocity (0.006 m.s⁻¹) and a gas velocity higher than 0.50 m.s⁻¹. But the removal efficiency is higher than 90 %. In fact, the liquid mass transfer resistance is low for the high liquid velocity (0.017 m.s⁻¹) because of a lowest limit liquid layer thickness. The high liquid velocity can also lead to a better distribution of the liquid phase in the shell side.

Nevertheless, rising gas velocity reduces the removal efficiency because of a lower contact time between the two phases. This effect is more significant with MDEA solution. This is due to a lower kinetic reaction with CO₂ than the MEA.

It can be clearly seen on Fig. 4 that the higher removal efficiencies are obtained with the blend than with MDEA solutions. The TETA activator action on the CO₂ removal efficiency is demonstrated.

Regarding the alkanolamine, increasing the MDEA mass fraction in blend has no significant effect on the removal efficiency because the CO₂ mass transfer is governed by the reaction CO₂-TETA. Furthermore, the CO₂ removal efficiency measured with the blend is equivalent to the efficiency measured with MEA aqueous solutions. No significant effect is observed with increase the MEA mass fraction. But, in case of MDEA aqueous solution, increased the alkanolamine mass fraction allows rising the removal efficiency. This is because a higher MDEA quantity is

free to react with CO₂. A raise by two of the MDEA mass fraction raises the CO₂ removal efficiency by a factor of 1.5.

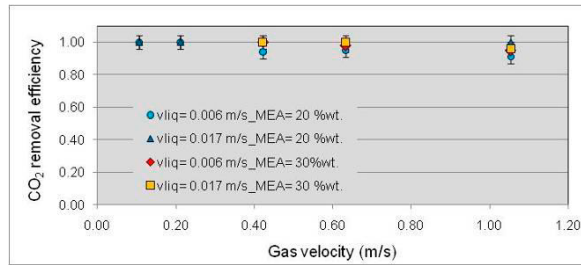

Fig 3: Influence of the gas and liquid velocities on the CO₂ removal efficiency with MEA, Oxyplus[®] 210 module, CO₂= 5 %, T = 295 K, P = 200 kPa.

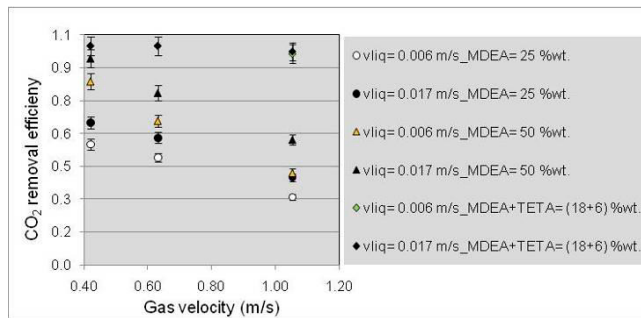

Fig 4: Influence of the phase velocities on the CO₂ removal efficiency with MDEA and MDEA + TETA, Oxyplus[®] 210 module, CO₂= 5 %, T = 295 K, P = 200 kPa.

3.2. Influence of packing fraction

The same liquid cross section for all modules is required to study influence of the packing fraction on the CO₂ removal efficiency. Experiments are conducted with a 5% CO₂ volume fraction in the gas phase and a 1.05 m.s⁻¹ gas velocity. Two liquid phases (a 30%wt MEA solution and a (18+6) %wt MDEA+TETA solution) and two liquid velocities (0.006 and 0.017 m.s⁻¹) are investigated. The modules characteristics are presented in Table 1.

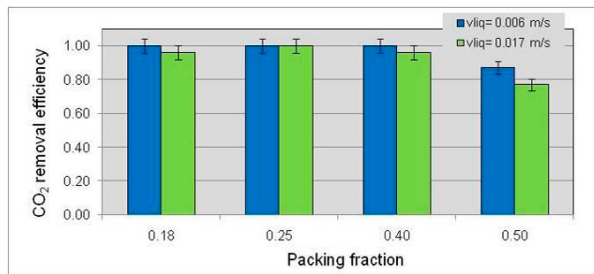

Fig.5: Influence of the module packing fraction on the CO₂ removal efficiency, Oxyplus[®] modules, liquid phase: MEA= 30%wt., T = 295K, P = 200 kPa

Results obtained (Fig. 5) for a packing fraction between 18 and 40 % allows having CO₂ removal efficiency higher than 90 %. But, if the packing fraction is higher than 40 % then the removal efficiency decreases. This can be explained by the creation of preferential channels around fibers bundles which decrease the overall mass transfer coefficient and the removal efficiency. These results are confirmed by results obtained with the blend of alkanolamines presented in Fig.6.

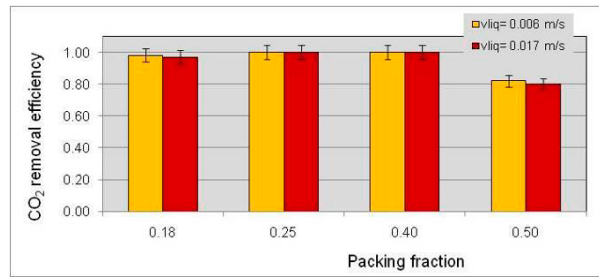

Fig.6: Influence of the packing fraction on the CO₂ removal efficiency with blend , Oxyplus® modules, liquid phase: MDEA+TETA=(18+6) %wt., T = 295K, P = 200 kPa

3.3. Influence of CO₂ fraction in the gas phase

Two CO₂ volume fractions (5 and 15 %), a 0.006 m.s⁻¹ liquid velocity and three liquid phases (MEA, MDEA and MDEA+TETA) are considered.

The CO₂ removal efficiency is equivalent for a gas velocity range from 0.40 to 0.9 m.s⁻¹ for both MEA and MDEA+TETA liquid phase (Fig. 9) and whatever the CO₂ volume fraction. A gas velocity higher than 0.9 m.s⁻¹ leads to a reduce of the CO₂ removal efficiency which is more significant for a 15 % CO₂ volume fraction. But the results are still equivalent for MEA and MDEA+TETA solutions; the CO₂ removal efficiencies are higher than 80 %.

Regarding MDEA aqueous solution, the removal efficiency is higher for the lower CO₂ volume fraction due to a lower kinetic reaction between CO₂ and MDEA. But for both CO₂ volume fraction used, the removal efficiency decreases with the raise of the gas velocity (Fig. 7).

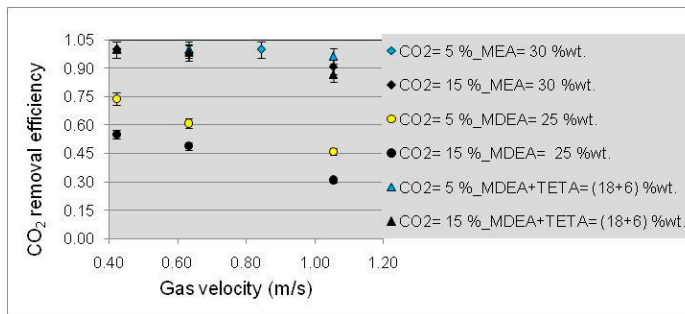

Fig.7: Influence of the feed CO₂ volume fraction on the removal efficiency, Oxyplus® 210 module, T = 295 K, P = 200 kPa, v_{liq} = 0.006.m.s⁻¹.

3.4. Influence of regeneration temperature

Experimental set-up allows measuring continuous absorption-desorption of CO₂ cycle. Influence of the regeneration temperature on the removal efficiency is investigated. A 30%wt. MEA solution beforehand loaded with CO₂ is used as liquid phase. For 7 hours, CO₂ absorption-desorption is measured by determination of carbonatation ratio, which is the amine fraction reacting with CO₂, using a correlation presented by [15]:

$$\alpha = 1 - 0.28315 \text{ pH} - 0.005663 \text{ T} + 273.15 - 0.021375 \text{ w}_{\text{MEA}} + 12.10461 - 3.33843 \quad (1)$$

Where α is the carbonatation ratio (-), pH is the pH of liquid phase (-), T is the liquid temperature (K), and w_{MEA} is the MEA mass fraction in liquid phase (%w/w).

A 15 % CO₂ volume fraction in the gas phase, a 1.05 m.s⁻¹ gas velocity and a 0.017 m.s⁻¹ liquid velocity are considered. Three regeneration temperatures are studied: 363, 373 and 383 K.

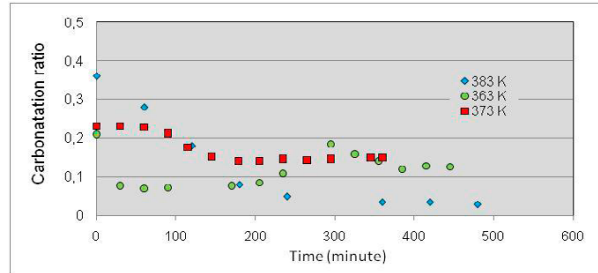

Fig. 8: Influence of the loaded liquid regeneration on the carbonatation ratio, P = 200 kPa. Oxyplus® 210 module, MEA = 30 %wt. CO₂ = 15 %, v_{gas} = 1.05 m.s⁻¹, v_{liq} = 0.017 m.s⁻¹

Fig. 8. shows the influence of temperature on the loaded liquid regeneration. A 383 K temperature allowed a complete regeneration of the liquid phase with a 0.4 initial carbonatation ratio. The removal efficiency was 89 %. A similar value is obtained for non-loaded conditions.

But a 363 or 373 K temperature leads to a decrease of the carbonation ratio up to a limit value which corresponds to the residual carbonatation ratio. In both cases, a 90 % removal efficiency is measured which is equivalent to results obtained in non-loaded conditions.

So, a 363 K regeneration temperature is enough to maintain a residual carbonation ratio and the CO₂ removal efficiency obtained in non-loaded conditions.

3.5. *Nature of dense outer layer.*

Two dense layers are investigated: a PTMSP layer and a PMP layer. Both have been coated on a PP support. The PTMSP is a polymer which is highly permeable to CO₂ (around 20 000 Barrer against 500 Barrer for PMP).

Fig. 9 shows a high removal efficiency for the lowest CO₂ fraction in the gas phase, similarly to Oxyplus® modules. Results obtained show that for the high gas velocities, the decrease of the CO₂ removal efficiency is more significant compared to Oxyplus® modules. This is probably due to the fact that thickness of PTMPS is around four times larger than thickness of PMP on the same support. The membrane resistance is thus governed by the layer thickness. As this is a dense material, the most important parameter is its permeability coefficient to CO₂.

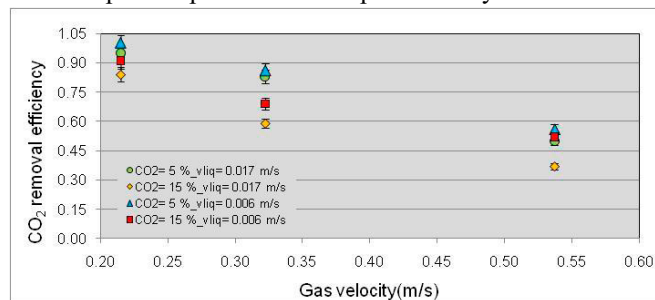

Fig.9: Influence of the CO₂ volume fraction and phases velocities on the CO₂ removal efficiency, PP-PTMSP module, MEA = 30 %wt., T = 295 K, P = 200 kPa

4. Conclusion

These preliminary results show that composite membranes can achieve promising performance for CO₂ postcombustion capture. These fibers are composed of a porous support coated by a

dense outer layer. The influence of several parameters on CO₂ removal efficiency has been studied: phase compositions, phase velocities, packing fraction and nature of layer. Three liquid phases has been used: MEA, MDEA and MDEA+TETA.

The influence of each parameter on the CO₂ removal efficiency obtained is in accordance with the results expected: higher removal efficiency for a high liquid velocity, a high alkanolamine mass fraction in the liquid phase, a low CO₂ volume fraction in the gas phase. Furthermore, CO₂ removal efficiencies obtained are equivalent for MEA aqueous solution and blend solution.

Influence of regeneration temperature is studied and has shown that 263 K is sufficient to have similar removal efficiency with fresh alkanolamine and a good regeneration of loaded liquid phase.

The resistance to wettability of composites membranes used has been validated. In fact, no wetting problem has occurred and CO₂ removal efficiency is maintained higher than 90 %.

Moreover, experiments have shown that dense layers governed the CO₂ mass transfer in the membrane. Thus, a particular attention must be brought to select the polymer which will be the dense layer and to coat porous support in order to maintain its physical-chemical properties.

5. Nomenclature

C	Concentration (mol.m ⁻³)
P	Pressure (kPa)
T	Temperature (K)
v	Velocity (m.s ⁻¹)
w	Mass fraction (%w/w)

Subscripts

CO ₂	Carbon dioxide
in	Inner
liq	Liquid
out	Outer

Greek letter

η	Removal efficiency (-)
---	------------------------

Abbreviations

MEA	Monoethanolamine
MDEA	Methyldiethanolamine
TETA	Triethylene Tetramine
PP	Polypropylene
PMP	Polymethylpentene
PTMSP	Polytrimethylsilylpropyne

6. References

- [1]: Cussler E.L., Zhang Qi, 1985, Microporous hollow fibers for gas absorption: I Mass transfer in the liquid & II: Mass transfer across the membrane, J. Membr. Sci., vol. 23, pp. 321-345.
- [2]: Rangwala H.A., 1996, Absorption of carbon dioxide into aqueous solutions using hollow fiber membrane contactor, J. Membr. Sci., vol. 112, pp. 229-240.
- [3]: Dindore V.Y., Brilman D.W.M., et Versteeg G.F., 2005, Hollow fiber membrane contactor as a gas-liquid model contactor, Chem Eng Sci, vol. 60, pp. 467-479.
- [4]: Gong Y., Z. Wang Z., S-C. Wang S.C., 2006, Experiments and simulation of CO₂ removal by mixed amines in hollow fiber membrane module, Chem Eng Process, vol. 45, pp. 652-660.

- [5]: Simons K., Nijmeijer K., Wessling M., 2009, A general model for membrane-based separation process, *J. Membr. Sci.*, vol. 340, pp. 214-220.
- [6]: DeMontigny D., Tontiwachwuthikul P., Chakma A., 2005, Using polypropylene and polytetrafluoroethylene membranes in a membrane contactor for CO₂ absorption, *J. Membr. Sci.*, vol. 277, pp. 99-107.
- [7]: Atchariyawut S., Feng C, Wang R, Jiratananon R., Liang D.T., 2006, Effect of membrane structure on mass-transfer in the membrane gas-liquid contacting process using microporous PVDF hollow fibers, *J. Membr. Sci.*, vol. 285, pp. 272-281.
- [8]: Yan S-P, Fang M-X, Zhang W-F, Wang S-Y, Xu Z-K, Luo Z-Y, Cen K-F, 2007, Experimental study on the separation of CO₂ from flue gas using hollow fiber membrane contactors without wetting, *Fuel Processing Technology*, vol. 88, issue 5, pp. 501-511.
- [9]: Kumar P.S., Hogendoorn J.A., Feron P.H.M, Versteeg G.F., 2002, New absorption liquids for the removal of CO₂ from dilute gas stream using membrane contactor, *Chem. Eng. Sci.*, vol. 57, pp. 1639-1651.
- [10]: Franco J.A, DeMontigny D., Kentish S.E, Perera J.M and Stevens G.W., 2009, Effect of amine degradation products on the membrane gas absorption process, *Chem. Eng. Sci.*, vol. 64, pp. 4016-4023.
- [11]: Wang R., Zhang H.Y., Feron P.H.M., Liang D.T., 2005, Influence of membrane wetting on CO₂ capture in microporous hollow fiber membrane contactors, *Sep. Pur. Technol.*, vol. 36, pp. 33-40.
- [12]: Lu J.-G, Wang L.-J, Sun X.-Y, Li J.-S, Liu X.-D, 2005, Absorption of CO₂ into aqueous solutions of methyl-diethanolamine and activated methyl-diethanolamine from a gas mixture in a hollow fiber contactor, *Ind. Eng. Chem. Res.*, vol. 44, pp. 9230-9238.
- [13]: Lu J.-G, Zheng Y.-F, Cheng M.-D, Wang L.-J, 2007, Effects of activators on mass-transfer enhancement in a hollow fiber contactor using activated alkanolamine solutions, *J. Membr. Sci.*, vol. 289, pp. 138-149.
- [14]: Kallas T., Chabanon E., Germain G., Bouallou B., 2009, Experimental study of CO₂ absorption in a hollow fiber membrane contactor, 12th Conference Process Integration, Modelling and Optimisation for Energy Saving and Pollution Reduction, Rome, Italy.
- [15]: Koonaphaddeert S., Wu Z., Li.K., 2009, Carbon dioxide stripping in ceramic hollow fibre membrane contactors, *Chem. Eng. Sci.*, vol. 64, pp. 1-8.
- [16]: Herzog H.J, 2001, What future for carbon capture and sequestration, *Environ. Sci. Tech.*, vol. 35, pp. 148A-153A.

Acknowledgement: The project was financed by French National Agency for Research (ANR) under CICADI project whose partners are: LRGP-Nancy, LGC-Toulouse, CEP-Paris, Polymem-Toulouse and TIPS-Moscow. This work has been also financially supported by the European Commission through the Collaborative Project CESAR - GA No. 213569 within the seventh framework programme (FP7)