



**HAL**  
open science

## Energy Fluxes optimization for PV integrated Building

Rim Missaoui, Ghaith Warkozek, Seddik Bacha, Stéphane Ploix

► **To cite this version:**

Rim Missaoui, Ghaith Warkozek, Seddik Bacha, Stéphane Ploix. Energy Fluxes optimization for PV integrated Building. 2011 IEEE Trondheim PowerTech, Jun 2011, Trondheim, Norway. 10.1109/PTC.2011.6019355 . hal-00604126

**HAL Id: hal-00604126**

**<https://hal.science/hal-00604126>**

Submitted on 28 Jun 2011

**HAL** is a multi-disciplinary open access archive for the deposit and dissemination of scientific research documents, whether they are published or not. The documents may come from teaching and research institutions in France or abroad, or from public or private research centers.

L'archive ouverte pluridisciplinaire **HAL**, est destinée au dépôt et à la diffusion de documents scientifiques de niveau recherche, publiés ou non, émanant des établissements d'enseignement et de recherche français ou étrangers, des laboratoires publics ou privés.

# Energy Fluxes optimization for PV integrated Building

Rim.Missaoui, Ghaith.Warkozek, Seddik. Bacha, Stéphane.Ploix.

**Abstract-** This paper presents an energy management system EMS controlling household energy capable both to satisfy the maximum available electrical energy constraint and to maximize user comfort criteria. It is composed into three layers: anticipation, reactive and device layers. Actually, this household energy control system is based on simple models. To validate them, we modeled the building more finely using MATLAB/Simulink. The validation is obtained through a real time simulation platform “RT\_LAB” capable of interoperating with EMS. At the end of this paper, some results of optimization of energy are presented.

**Index Terms--** Energy management system EMS, validation, application building, real-time simulation

## I. NOMENCLATURE

$t$	Sampling step time, [hour].
$\Delta$	Sampling time of the anticipatory layer.
$i$	The service $i$ .
$k$	The number of Period.
$E_t$	Consumed energy by the timed service [kWh].
$E_{max}$	The maximum produced energy [kWh].
$E_{pv}$	Energy produced locally by the PV[kWh].
$E_{cons}$	Total of energy consumed by the load [kWh].
$E(i, k)$	Energy produced by the source $i$ during period $k$ [kWh].
$P_{pv}$	PV power produced locally [W].
$P_{sol}$	Solar radiation energy [W].
$P_{cons}$	Load consumption [W].
$\rho < 1$	Efficiency of the installation.
$\tau_{CO_2}(i, k)$	The volume of CO <sub>2</sub> emitted by source $i$ during period $k$ .
$C(i, k)$	The unit cost of energy produced by source $i$ during period $k$ .

$C_{tot}$	Total cost of the system (€/kWh).
$price_{auto}$	Self consumption price (€/kWh).
$price_{bought}$	Bought energy price (€/kWh).
$price_{sold}$	Purchasing price for PV production injected to network, (€/kWh).
$T_{out}$	The temperature outside the room[K].
$T_{in}$	Instantaneous temperature in the room $i$ [K].
$T_{op}$	The optimum heating temperature [K].
$T_m$	The temperature outside the room [K].
$K_{heaters}, K_{sun}, \tau$	Constants.
$\Phi_{heater}$	Heat flux given by the radiator.
$\Phi_{sun}$	Heat flux of sunlight through the window.
$C_i$	Air Heat capacity of the room $i$ [J / K].
$C_m$	Envelope heat capacity of the room[J / K].
$SF$	Window Area [m <sup>2</sup> ].
$a_1...a_4; b_1...b_4$	Constants.
$f(i)$	The end effective date of the operating cycle of the timed service.
$f_{opt}$	End date desired by the user of the timed service.
$s(i)$	The starting time of timed services.

## II. INTRODUCTION

T ODAY, energy consumption in the residential sector accounts for more than 64 per cent of total electricity demand in France [1]. This situation has a clear impact on the environment (the buildings are the second largest source of CO<sub>2</sub> emissions [1]), and on the user’s budget. However, buildings are considered as primordial source of energy savings, leading to a large field of researches on this topic. In general, these researches are following two main directions which are: the improvement of building components and increasing the efficiency of buildings by an adequate Energy Management System EMS.

An EMS [2] basically consists of appliances linked via a communication network allowing appliances to communicate with each other. These home automation systems can carry out a new load management mechanism which is called distributed control [3]. This EMS control allows energy providers to charge users for the actual energy production

This paper has been supported by the French National National Research Agency ANR - Project: RéactivHome

R.Missaoui, G.Warkozek, S. Bacha and S.Ploix are with the Institut National Polytechnique de Grenoble, Université de Grenoble, 38000 Grenoble, France Grenoble Electrical Engineering Laboratory (G2ELAB) CNRS - INPG / UJF. BP 46-38402 Saint Martin d’Hères, French.

G-SCOP Laboratory of Grenoble for Sciences of Conception, Optimization and Production, FRE3028, BP46, F-38402 Saint Martin d’Hères Cedex, France

(email:rim.missaoui@g2elab.inpg.fr; ghaith.warkozek@g2elab.grenoble-inpg.fr; Seddik.Bacha@g2elab.inpg.fr; stephane.ploix@inpg.fr).

cost in a very precise way. It also allows users to adjust their power consumption according to energy price variation. In the peak period, the domestic customer would be able to decide whether to wait and save money or to use appliances even so. This strategy is more reactive than the basic EMS control but more complex to control when comfort has to be taken into account.

This EMS is composed by three control layers [4-5]. The first layer is called the anticipative layer. Its aim is to plan consumption and production of energy according to meteorological data and grid requirements. The second layer is the reactive one, it will respond by disabling/enabling the use of certain services in order to establish the energy balance if energy sources are unavailable or restricted. Finally, the objective of the device layer is to execute instructions, which were calculated by the anticipative layer, and possibly adjusted by the reactive layer.

This paper proposes a solution to validate the EMS algorithm, using a simulator capable of interoperating with this system. The solution based on a real-time simulation with a networked system that manages energy flows. It makes it possible to perform fine simulations of the physics, including fast dynamics of electrical appliances of building system. It is also possible to connect real appliances to the simulator in order to study how they behave during commutations. The electric architecture is given on “Fig.1”, representing the duality sources/loads on presence of PV generation and Grid connection. The electric system is managed by a three layers control system (Expert and Predictive).

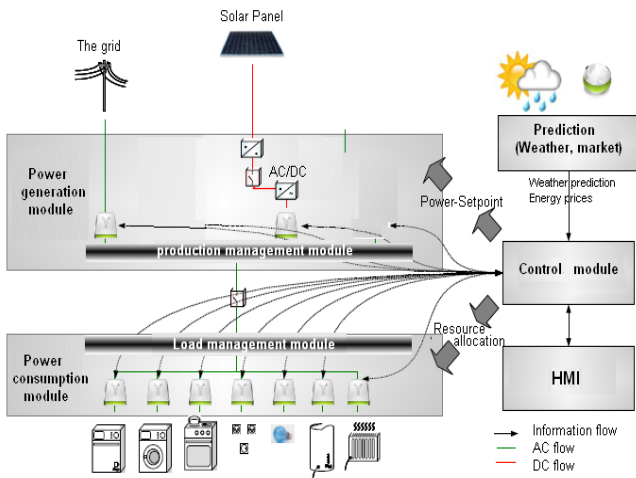

Fig 1: Grid-Connected PV Systems and loads co-Management System architecture.

The rest of paper is organized as follow: section III present the architecture of the energy management system (EMS) . In section IV, we presented the control model given bay the EMS. A simulation models for building is modeled with high accuracy, in order to validate EMS in section V. In section VI a validation of EMS problematic is proposed and solution for the previous problematic is given in section VII. At the end of this paper, some primary real time results of optimization of energy are presented.

### III. ARCHITECTURE OF THE EMS

An important issue in the problems of home automation is the uncertainty in the models and in the predicted data such as solar radiation, temperature or services requested by the occupants. To solve this problem, three-layer architecture is presented in Fig.2 (see [5]): a layer of anticipation, a reactive layer and a local layer.

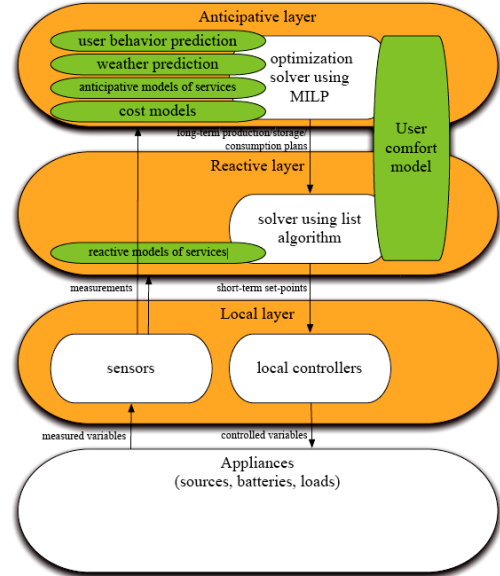

Fig.2: The multi-layer system of power management.

#### A. First layer of control: The anticipation layer

The anticipation layer includes control that operates on average quantities associated with long periods of time (typically 1 hour) in the EMS. Its objective is to plan production and consumption of energy over long time covering typically one day. The prediction is based on weather forecasts and on user programming for appliances.

If consumption of all facilities can be anticipated, it is possible to plan and schedule their operations in advance. For example, for an electric heating service of a room, we can calculate the duration and the amount of overheating "anticipated" which will reduce the consumption during a period where power is unavailable, restricted or more expensive. For the case of a time-shifted service such as the service provided by a washing machine for example, we can delay or advance its start to shape the overall consumption [6]

#### B. Second layer of control: the reactive layer.

Because the anticipation mechanism works with average values over relatively long periods on the basis of predicting energy needs, a finer level to respond to disturbance (modelling errors and errors of prediction) is necessary. This level operates with a short period of time (typically 1 minute) comparing to the anticipation layer in order to meet the criterion of comfort for the occupants and the capacity constraints of energy sources. Practically, if the actual situation deviates too much from the anticipation plan and

exceeds energy resources for example, the reactive layer will respond by shedding the consumption of certain appliances in order to satisfy feasible energy balances. Since the time scale is small compared to the proactive mechanism, adjustments calculated by the reactive layer remain negligible for the proactive layer which only calculates average values if the predictions were consistent with the actual situation [7].

### C. Third layer of control: the local layer.

This control layer is the one with the fastest dynamics. Its goal is to apply set points, computed by the anticipation layer and possibly adjusted by the reactive layer. For example, in a thermal environment, this mechanism aims at maintaining the temperature to values close to temperature set points temperature. This mechanism is provided by appliance manufacturers and not modified.

Such an EMS must be validated on a fine simulation tool because the algorithms for managing energy flows are based on simplified models. This work presents a methodology used for these fine system simulations. Initially, we modelled a multi-source and multi-loads home to validate the global control algorithm. The modelling has been done in the MATLAB / Simulink environment supplemented by a specific real-time library [8].

## IV. CONTROL MODEL.

Sources and load co-management used in the EMS are formulated as Mixed Integer Linear program MILP [4-5]. The problem is formulated and implemented in Java. In this paper, we present just the mathematical formulations for control models before the linearization.

Because of the importance of stochastic events such as perturbation induced by humans, outdoor temperature or solar radiations, a precise predictive model cannot be found. However, a relevant model for anticipation has to be defined. It should cover three aspects: electrical power, thermal behavior and user comfort [9].

### D. Sub problem N°1: Calculating the optimal sequence of modular service (Heating service).

In modular service it is possible to modulate the energy flow. Also it can be interruptible. The first sub problem addressed in the anticipation layer is to calculate the optimal sequence of modular service.

The purpose is to find the temperature inside the room  $T_{in}$  and the consumed energy  $E_c$ . The thermal model used by the anticipatory layer is:

$$\frac{d(T_{in} - T_{out})}{dt} = -\frac{1}{\tau}(T_{in} - T_{out}) + \left(\frac{K_{heater}}{\tau}\right)\phi_{heater} + \frac{K_{sun}}{\tau}\phi_{sun} \quad (1)$$

Also, this layer calculates the thermal satisfaction as a function of temperature:

$$y_T(i, k) = \begin{cases} a_1 T_{in}(i, k) + b_1 & \text{if } T_{in}(i, k) \leq T_{opt} \\ a_2 T_{in}(i, k) + b_2 & \text{if } T_{in}(i, k) \geq T_{opt} \end{cases} \quad (2)$$

Hence the criterion of comfort.

$$Y_T(i) = \sum_{k=1}^K y_T(i, k) \quad (3)$$

### E. Sub problem N°2: Calculating the starting time of timed services $s(i)$ (Washing machine).

The second problem addressed in the anticipation layer is to calculate the starting time for the timed service.

$$E_t(i, k) = \begin{cases} E'_t(i, k) = (\text{Min}[f(i), (k+1)\Delta]) - \\ \text{Max}[s(i), k\Delta])P(i) & \text{if } E'_t(i, k) > 0 \\ 0 & \text{if } E'_t(i, k) \leq 0 \end{cases} \quad (4)$$

The comfort criterion is expressed as follows:

$$y_S(i) = \begin{cases} a_3 f(i) + b_3 & \text{if } f(i) \leq f_{opt} \\ a_4 f(i) + b_4 & \text{if } f(i) > f_{opt} \end{cases} \quad (5)$$

### F. Sub problem N°3: Calculating the energy produced by each source:

$$E(i, k) \leq E_{max} \quad (6)$$

The energy cost criterion  $J_c$  et  $CO_2$  emissions  $J_e$  is written:

$$J_c = C(i, k) \times E(i, k) \quad (7)$$

$$J_e = \tau_{CO_2}(i, k) \times E(i, k)$$

### D. Sub problem N°4: Manage the service for resale of energy produced locally $E_{pro}$ :

$$\text{Import method if } E_{pro}(k) \leq E_{cons}(k) \quad (8)$$

$$\text{Export method if } E_{pro}(k) > E_{cons}(k)$$

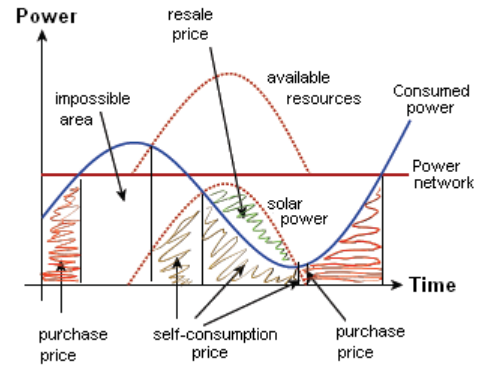

Fig 3: Strategy of energy purchasing

$$C_{tot} = -price_{auto} \min(P_{PV}; P_{cons}) + price_{bought} \max(P_{cons} - P_{PV}; 0) - price_{sold} \max(P_{PV} - P_{cons}; 0) \quad (9)$$

## V. SIMULATION MODEL FOR BUILDING

To validate the optimal control approach presented in section III, we modelled the building more finely in

MATLAB / Simulink. This model contains the grid, PV panels and three loads: two permanent loads (heating and fridge) and on a timed load (washing machine).

#### A. Sources simulation model:

The distribution network is modelled by a simple voltage source controlled by a switch-on current (limited to the value imposed by subscription).

Regarding renewable source, the PV system is sized with 2 KW peak. The power generated  $P_{PV}$  is 10% of solar energy radiated  $P_{sol}$  measured in real time based on weather data every 10 minutes from Grenoble (France). Hence  $P_{PV} = \rho \cdot S \cdot P_{sol}$ , where  $\rho = 0.1$  is the performance of the PV system and  $S$  is the capture area of radiation ( $m^2$ ).

#### B. Loads simulation model:

To illustrate the results of the optimization of energy flows in the building, we modify the behaviour of some electrical appliance.

TABLE I:  
LIST OF MODELLED EQUIPMENT.

Name	Power max (kw)	Modelled as
Heating system	1.00	permanent service unit
Refrigerator	0.10	permanent service
Washing	2.40	timed service

#### 1) Heating simulation model:

In this example, the heating service is provided by a single heater 1KW. In the real case study, this service is provided by heaters in each room of the flat. The chosen model in [10] is finer than the model selected by the management system. This is a first order linearized model, whereas Simulink models are not linearized. In addition, they depend on several factors such as the structure (surfaces, heights, walls, insulation, windows, the outside temperature, the solar radiation...).

This thermal model can be formulated as follows:

$$\begin{bmatrix} \frac{dT_{in}}{dt} \\ \frac{dT_m}{dt} \end{bmatrix} = \begin{bmatrix} -\left(\frac{1}{r_i C_i} + \frac{1}{r_m C_i}\right) & \frac{1}{r_m C_i} \\ \frac{1}{r_m C_m} & -\frac{1}{r_m C_m} \end{bmatrix} \begin{bmatrix} T_i \\ T_m \end{bmatrix} + \begin{bmatrix} \frac{1}{r_m C_i} & \frac{1}{C_i} & \frac{SF}{C_i} \\ 0 & 0 & 0 \end{bmatrix} \begin{bmatrix} T_{ext} \\ \Phi_h \\ \Phi_s \end{bmatrix} \quad (10)$$

#### 2) Refrigerator simulation model:

The fridge and freezer are thermal services whose models are closed to the one of a room with heater except that the sun has no impact.

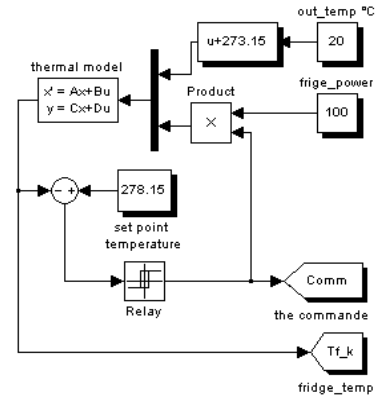

Fig 4: MATLAB/Simulink model of refrigerator

#### 3) Washing machine simulation model:

We modelled the behaviour of the washing machine by three cycles whereas the model used by the EMS has an only one cycle operation (see Fig 5).

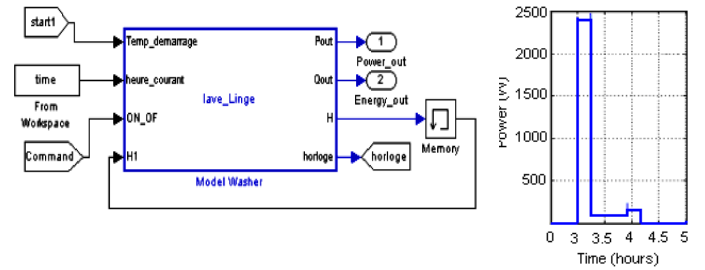

Fig 5: MATLAB/Simulink simulation model of washing machine

TABLE II:  
ENERGY DISTRIBUTION AND AVERAGE LENGTH OF CYCLES

	Cycle time (mn)	Power (W)
Temperature	30/40°C	**
Cycle average length	70	**
Heating	15	2400
Washing and rinsing	40	80
Spinning	15	150

## VI. PROBLEMATIC: VALIDATION OF ENERGY MANAGEMENT SYSTEMS.

To validate the EMS by a fine simulation, some problems have been encountered. The EMS and the physical simulator use different solving platform. For example, the EMS is a Java application coupled with solvers whereas the simulator is not available in Java. Models in MATLAB/Simulink, TRANSYS [11], Energy+,..., are usually used.

The second problem is the synchronization of the EMS with the physical simulator. Indeed, accelerated time requires shared clocks.

The fine simulation is based on detailed physical models, hence the need for a large enough computing power, which is not necessary for EMS. Therefore, in this work, architectural solution is proposed. The EMS is interfaced with the

simulation model running on real-time platform (RT\_LAB [8]) with Ethernet communication.

VII. PROPOSED SOLUTION: VALIDATION WITH REAL TIME SIMULATION.

The validation here aims to assess the performance of EMS simulated data with a very fine time scale ( $\mu s$ ), and to allow overcoming instrumentation of a real building system.

The validation tool is a real time simulator RT-LAB [8]. The advantage of real-time compared to the virtual simulation is firstly that it is an easy way to solve the synchronisation problem between the simulator time and the EMS time but also that is possible to connect real appliances (hardware-in-the loop simulation).

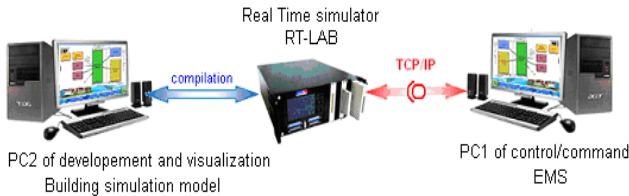

Fig 6: Real time platform

The test environment consists of two computers and the real-time simulator RT\_LAB. The first computer is used to design simulation models of system building and also to visualize simulation results. The second computer is a control station which is devoted to the EMS where the communications is under TCP/IP protocol. The EMS must be able to act on the simulator. A communication tunnel has been developed to transfer the commands of the EMS to the simulated models (under RT\_LAB), and to transfer the state variables of the simulated models to the EMS.

To achieve this goal, the architecture shown in “Fig.7” is designed to establish a socket for each model (service), then to take orders and measurements via this socket. Each service simulated in RT\_LAB has a counterpart in the energy management system; correspondence is done by the port number of each socket. This package has been developed in Java.

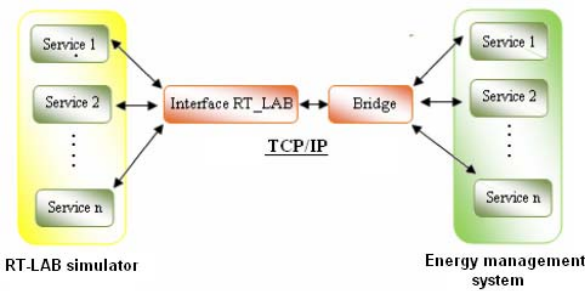

Fig 7: XML Interface.

VIII. SIMULATION RESULTS.

A PV system is integrated to the building assuming the German energy tariffs (re-selling surplus is authorised). The German energy policy gives preference to the local consumption from the grid when there is enough production.

In addition, when production exceeds consumption, surplus is resold to the grid (negative price of energy cost).

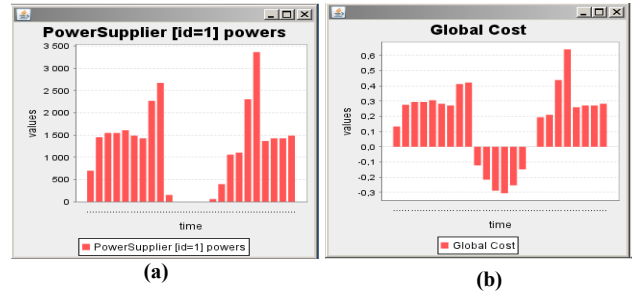

Fig 8: Power supplier (a) (W) and global cost of energy (b) (€/KWh)

Data and control signals exchanged between the simulator and the EMS are summarized in the following “Fig 9”:

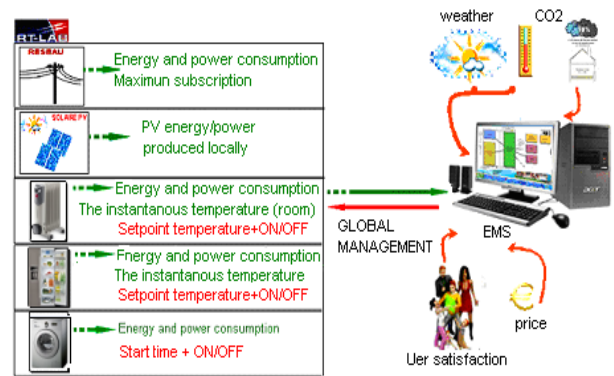

Fig 9: Exchanged command (red) from MS and data (green) from Simulator

In this case study and according to data sent by the simulator, the EMS creates a problem then solve it. The solution made of set point for the different loads of the building is shown in “Fig.10”:

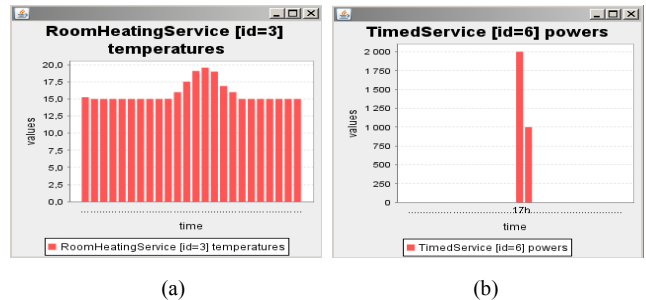

Fig 10: Temperature set points (°C) during 24 hours and starting time sent by the EMS to the MATLAB/Simulink simulator

The optimal temperature for the heating service is  $T_{opt}=18^{\circ}C$ . “Fig (10-a)” shows that the temperature set point temperature sent by the EMS varies around the optimum temperature. The EMS chose to heat the room in the period of sunshine where there is enough power. So it sends a reference temperature exceeds the optimum temperature.

The computed starting time for the washing machine is 05:00 pm (see Fig.10-b). The starting time of the washing machine found by the management system is delayed from

user start time (8 am) to (5 pm). At this moment, the energy consumption of the system is low and energy prices are favorable.

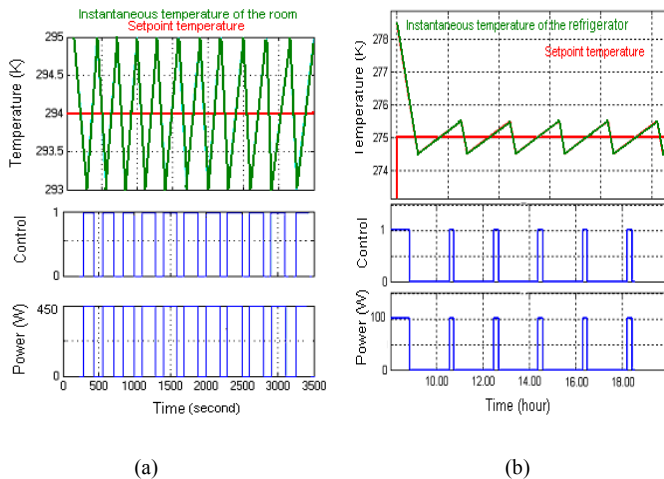

Fig 11: The real time simulation results from (PC1) for the heating (a) and refrigerator (b) model

The real time simulation results from (PC1) during one hour are shown in “Fig. 11”. There is a local control ( $\pm 1$  Kelvin) on the simulation model that follows the EMS command (the read line).

“Fig.8 and 10” show the solution given by the anticipative layer. Figure 11 is a real time simulation for the whole system (building simulation done with MATLAB connected to the EMS).

## IX. CONCLUSION

A method for the energy fluxes optimization of PV-based multi-source system and energy management for household application is proposed in this paper. As the system is characterized by the intermittence of primary source and possible unpredicted behaviors of customer, the two control layers are proposed for better anticipating the operation of system and dealing with disturbances. Also, this work proposes a solution to validate the commands of the Energy Management System EMS. The validation is obtained through real-time simulation platform "RT\_LAB", capable of performing calculations at a time step up to  $10\mu s$ .

The EMS calculates optimal scheduling for the service in the housing. It compute the optimal setpoint temperatures for heating services and the best starting time for the washing machine taking into account the cost and comfort criterion.

The perspectives of this work are firstly to expand the validation of EMS with other loads such as lighting, cooking, oven, microwave ect, but also to simulate the impact of occupants.

The real-time simulation is an interesting way to solve the synchronization problems between EMS and simulators but long period simulations are nevertheless difficult to manage. Solutions to accelerated simulations have to be developed. However, real-time simulations make hardware-in-the-loop

simulations possible: it is therefore possible to model only a part of the system.

## REFERENCES

- [1] ADEME. Les Energies et Matières Premières Renouvelables en France - Situation et perspectives de développement dans le cadre de la lutte contre le changement climatique, March, 26, 2003, part 2, available on line [www.debat-energie.gouv.fr/site/pdf/enr-2.pdf](http://www.debat-energie.gouv.fr/site/pdf/enr-2.pdf)
- [2] Wacks, K., 1993. The impact of home automation on power electronics. In : Applied Power Electronics Conference and Exposition. pp. 3 - 9.
- [3] Palensky, P., Posta, R., 1997. Demand side management in private home using lonworks. In : Proceedings.1997 IEEE International Workshop on Factory Communication Systems
- [4] Duy Long Ha, Stephane Ploix, Mireille Jacomino and Minh Hoang Le (2010). Home energy management problem: towards an optimal and robust solution. Energy Management, Francisco Macia Perez (Ed.), ISBN: 978-953-307-065-0, INTECH.
- [5] Clastres C., Ha Pham, T.T., Wurtz, F., Bacha, S. (2010). Ancillary services and optimal household energy management with photovoltaic production. Energy, Vol. 35, n° 1, pp. 55-64
- [6] S. Abras, Système domotique Multi-Agents pour la gestion de l'énergie dans l'habitat. Thèse de Doctorat - Institut National Polytechnique de Grenoble (INP Grenoble) Grenoble, Mai, 2009, chapitre 5 et 6, page 61-129
- [7] Duy Ha, L. (2007). Un système avancé de gestion d'énergie dans le bâtiment pour coordonner production et consommation. Thèse de Doctorat - Institut National Polytechnique de Grenoble (INP Grenoble) Grenoble, Septembre, 2007
- [8] [http://www.opal-rt.com/sites/default/files/rtlab\\_brochure\\_en.pdf](http://www.opal-rt.com/sites/default/files/rtlab_brochure_en.pdf)
- [9] Ha, D. L., Ploix, S., Zamai, E. & Jacomino, M. 2006. Tabu search for the optimization of household energy consumption, The 2006 IEEE International Conference on Information Reuse and Integration IEEE IRI 2006: Heuristic Systems Engineering September 16-18, 2006, Waikoloa, Hawaii, USA.
- [10] Kampf, J. H. et Robinson, D. (2006). A simplified thermal model to support analysis of urban resource flows. Energy and Building, InPress. (cité page 58).
- [11] A. DAMIAN, A., VIRGONE, J., FRAISSE, G. *Modélisation thermique d'un bâtiment monozone dans l'environnement TRNSYS*. Bulletin Scientifique de l'UTCB (Université Technique de Construction de Bucarest), n°3, 1997

## BIOGRAPHIES



**Missaoui Rim** was born in Souassi, Tunisia, on June 1, 1983. She received the Engineering degree in electrical engineering from the National Engineering School of Monastir, Monastir, Tunisia, in 2007 and the Recherche Master degree from the Institute National Polytechnique de Grenoble, Grenoble University, Grenoble, France, in 2008. She is currently working toward the PhD degree with the Institute National Polytechnique of Grenoble.



**Warkozek Ghaith** was born in Damascus, Syria, 1982. He received the Engineering degree in electrical engineering from Faculty of Electrical and Mechanical Engineering, Damascus, Syria, in 2005 and a Master in Advanced Study (MAS) in 2006 from Damascus University. A Research Master Degree from the Grenoble Institute of Technology, Grenoble University, Grenoble, France, in 2007. He is currently working toward the PhD degree in Grenoble Institute of Technology Grenoble.



**Stéphane Ploix** is *Maître de Conférences* at the Grenoble Institute of Technology in the GSCOP lab. After an engineer degree in mechanics and electricity, in 1998 he obtained a Ph.D. from *Institute National Polytechnique de Lorraine* in control engineering and signal processing and the HDR degrees in 2009. He is a specialist in supervision, monitoring and diagnosis, and his studies focus on human-machine cooperative mechanisms. He is involved in different industrial projects dealing with the supervision of distributed plants, the diagnosis of human skills, iterative diagnosis tool for companies and power management in building.



**Seddik Bacha** received the Engineer and Magister degrees from Ecole National Polytechnique of Algiers in 1982 and 1990, respectively. He joined the Electro technique Laboratory de Grenoble (LEG) and received the PhD and HDR degrees in 1993 and 1998, respectively. He is currently Manager of the Power System Group of LEG and Professor at the University Joseph Fourier of Grenoble, France. His main fields of interest are power electronic systems modelling and control, power quality, and renewable energy integration.