



HAL
open science

Energy saving in a crude distillation unit by a preflash implementation

Massimiliano Errico, Giuseppe Tola, Michele Mascia

► To cite this version:

Massimiliano Errico, Giuseppe Tola, Michele Mascia. Energy saving in a crude distillation unit by a preflash implementation. Applied Thermal Engineering, 2009, 29 (8-9), pp.1642. <10.1016/j.applthermaleng.2008.07.011>. <hal-00596597>

HAL Id: hal-00596597

<https://hal.science/hal-00596597v1>

Submitted on 28 May 2011

HAL is a multi-disciplinary open access archive for the deposit and dissemination of scientific research documents, whether they are published or not. The documents may come from teaching and research institutions in France or abroad, or from public or private research centers.

L'archive ouverte pluridisciplinaire HAL, est destinée au dépôt et à la diffusion de documents scientifiques de niveau recherche, publiés ou non, émanant des établissements d'enseignement et de recherche français ou étrangers, des laboratoires publics ou privés.



HAL Authorization

Accepted Manuscript

Energy saving in a crude distillation unit by a preflash implementation

Massimiliano Errico, Giuseppe Tola, Michele Mascia

PII: S1359-4311(08)00317-7
DOI: [10.1016/j.applthermaleng.2008.07.011](https://doi.org/10.1016/j.applthermaleng.2008.07.011)
Reference: ATE 2580

To appear in: *Applied Thermal Engineering*

Received Date: 7 September 2007
Revised Date: 4 April 2008
Accepted Date: 15 July 2008

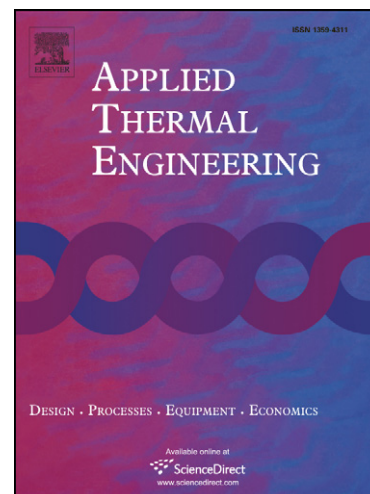

Please cite this article as: M. Errico, G. Tola, M. Mascia, Energy saving in a crude distillation unit by a preflash implementation, *Applied Thermal Engineering* (2008), doi: [10.1016/j.applthermaleng.2008.07.011](https://doi.org/10.1016/j.applthermaleng.2008.07.011)

This is a PDF file of an unedited manuscript that has been accepted for publication. As a service to our customers we are providing this early version of the manuscript. The manuscript will undergo copyediting, typesetting, and review of the resulting proof before it is published in its final form. Please note that during the production process errors may be discovered which could affect the content, and all legal disclaimers that apply to the journal pertain.

ENERGY SAVING IN A CRUDE DISTILLATION UNIT BY A PREFLASH IMPLEMENTATION

Massimiliano Errico*, Giuseppe Tola, Michele Mascia

Dipartimento di Ingegneria Chimica e Materiali, Università degli Studi di Cagliari, P.zza D'Armi s.n.,
09123 Cagliari, Italy

Abstract

After the 70's energy crisis the revamping of plants designed before this date is very attractive for improving energy recovery and lowering operation costs.

A typical case is the oil refinery plant where an intensive usage of energy takes place and is a promising case for the application of energy saving solutions. In this work we focused our attention to an industrial crude oil distillation unit, evaluating the possibility to modify the feed conditions by installing a preflash drum or a preflash plate column.

Real data plant were collected to obtain a reliable simulation of the unit by means of the software package Aspen Plus 13.0. To characterize the crude oil fed the TBP curve was used. The results obtained were compared with the plant data in terms of flow rate and product quality utilizing the ASTM D-86 curves and a good agreement was obtained. According to the specialized literature the preflash drum/column was placed at the end of the pre-heat train, just before the column furnace.

The furnace is the bottleneck of the plant and with both the preflash devices it is possible to lower its energy consumption. However the energy reduction is associated to the decrease of one kind of

distillates (light or middle). The choice of the best preflash device was made according to the production asset of the plant.

Keywords: Preflash drum; Preflash column; Energy saving; Crude distillation unit

ACCEPTED MANUSCRIPT

* Corresponding author. Tel.: +390706755070; fax: +390706755067. E-mail address:

m.errico@dicm.unica.it (M. Errico).

1. Introduction

Refineries are among the largest energy consumers in the chemical industries. It was evaluated that the energy requirement for these plants is an amount of fuel equivalent to the 2% of the total crude processed [1]. For this reason there is a continuous interest to identify ways to improve the energy efficiency of the existing plants.

Different solutions were proposed during the years; in the first half of 80's the most popular strategy to increase energy recovery between process fluids was the Pinch method [2], after that other solutions were considered including also the modification of the distillation design. One popular revamping solution is the employing of preflash devices, a drum or a column, to save energy in crude distillation plants following the first indication given by Brugma [3].

The basic idea of a preflash device implementation is to remove the light components of the crude before entering in the furnace. The vapour stream obtained can then be introduced at the furnace outlet or in an appropriate location of the main column. In this way it is possible to reduce the heat duty of the distillation unit and to have also an improvement of the hydraulic performance of the heat exchanger network [4,5].

It is a common opinion [6] that the best preflash location is downstream the desalting process in order to remove, with the light components, also the water carryover that can cause corrosion in the following devices or vaporization in the control valves.

Two main approaches for the preflash implementation have been considered in the literature; the first concerns the impact of the preflash device on the heat exchanger network, and the second is about the impact of this device on the main column performance. In the former category Harbert [4], Feintuch et al.[5] and Yahyaabadi [6,7] made a very clear review of the problem giving useful information to complete the general knowledge about the behaviour of the system. Feintuch et al. consider the

modification of the preheating crude network to increase the energy recovery; they focus their attention on the maximum utilization of the existing equipment. In particular they consider the hydraulic limitations and the pressure drop of the modified system and observe that the implementation of a preflash drum just downstream the desalter is able to decrease the operative pressure of the heat exchangers between the flash drum and the furnace. Thus no new equipments are necessary to increase the energy savings in the whole heat exchanger network. They also report that this solution is cost effective with a payout period of less than 3 years. Yahyaabadi [6,7] studies common problems in preheating trains and the best placement of the preflash drum in the preheat train network below the desalter. He finds that the location of the preflash device has only a small effect on the hot and cold utility consumptions but it is of great importance on the pressure drop and on the average skin temperature of the furnace. There are also same cases in which it is possible to remove part of the heat exchanger network obtaining additional savings on the operating costs. Recently it is also considered the possibility to employ a preflash system for heavy oils [8], that up to now was not taken into account due to the small amount of vaporization that can be achieved. However also in this case it is possible to eliminate water carryover from the desalter and some lightest components, thus reducing the pressure at the furnace inlet.

The second approach considered is the study of the behaviour of the main column when the preflash device is introduced. In this case there are many criticisms about the possibility to achieve a real energy saving. We refer in particular to the meaningful works of Ji and Bagajewicz [9] and of Golden [10]. The former work includes the preflash drum or the preflash column in a design method for the whole system including the main column. They make a detailed analysis explaining the effect of the lightest compounds of the crude, called carrier-effect, in improving the separation of the gas oil fraction and also compared different carrier gases to improve the gas oil yield. In another work [11] the same authors consider the preflash and the main column system integrated with the vacuum column,

obtaining that the whole system has an energy request slightly smaller than the base design without the preflash system.

The position of Golden [10] on the performance of the preflash device is more critical. He analyzes many parameters that influence the performance of the main column, like the flash drum temperature, the flashed vapour feed location, the effect of flashed crude entrainment in the vapour stream and the quench effect of the flashed vapour in the main column with a fixed outlet furnace temperature. He made a complete study of the preflash drum theory and reports a revamp case. This case study fails due to a feed lighter than the design case highlighting the necessity to design the preflash system for the light oil processed. Anyway this result can not be considered meaningful of a poor preflash performance. In fact every device has a maximum efficiency in the design operative range, so it is usual that poor performance happens in different situations.

Our study starts by considering a real Crude Distillation Unit (CDU) with high energy consumption due to the high furnace duty, and we aim to evaluate the possibility of energy savings utilizing a preflash device. This problem is different from the previous works already published, because utilizes real plant data and describes how it is possible to obtain a compromise between production and energy savings without changing the main column lay out.

2. Description of the plant

The crude distillation unit is the first separation process that takes place in a refinery plant.

Fig. 1 shows a simplified view of the plant. A 42°API crude, stored at a temperature of about 50°C, is heated in the first section of the heat exchanger network that utilizes as heating stream the lightest streams from the main column; in this way the crude oil reaches a temperature of about 120°C and is fed to the desalter to remove inorganic salts, impurities and soluble metals. Then the desalted crude flows through the second section of the heat exchanger network. Due to the great attention on energy integration, by maximising heat exchanges between the crude oil and the product streams from the main column, the crude can reach a maximum temperature of about 240°C.

This temperature is still too low to achieve the grade of crude vaporization necessary for the separation in the main column and thus a furnace is always necessary. The temperature of the exiting stream from the furnace is about 345°C and fuel oil or fuel gas, depending on the refinery availability, is used as energy source. All the heat needed for the separation is given in the furnace, so no reboilers occurs in the main column. The high temperature difference between the inlet and the outlet streams of the furnace and the high flow rate of the crude processed make the furnace as one of the higher energy consumer of the whole refinery. It follows that also the cost of this unit is a meaningful part of the overall production costs.

From the exit of the furnace the heated crude is fed to the main column that is a conventional crude distillation column able to process about 940 m³/h with the main characteristics summarized as follows:

- a stripping section with few plates below the feed location and a steam stream introduced in the bottom to strip the light components dragged in the liquid;
- four product side withdrawals; that from the top to the bottom, are: heavy naphtha (HN), kerosene (Kero), light gasoil (LGO), heavy gasoil (HGO). The Kero, LGO, HGO streams are steam stripped

steam in side columns and the vapours are fed again to the main column a few plates above the withdrawn. The stripped liquid goes in the heat exchanger network for the feed preheating. Each side stripping column has four plates with steam and liquid moving countercurrent;

- two pumparounds corresponding to the HN and the LGO sidestreams to regulate the vapour and liquid loadings;

- a partial condenser from where a light naphtha (LN) stream is obtained as liquid distillate and partially refluxed to the column. In this unit a stream of incondensable and fuel gas is also obtained, and part of this stream is recycled into the condenser to maintain a proper value of the pressure. The water added in the column with the bottom steam and with the side strippers is removed in the condenser's pot and is sent to the waste water plant unit.

The CDU has a strategic role in the overall production asset. In fact the product streams for the main column are the feed for other units of the plant, so the global performance of the refinery production is strictly related to the first separation that takes place in the CDU.

3. Simulation of the plant

To make a comparison between different retrofit solutions for an existing plant it is necessary to start from a simulation that is as much as possible close to the real plant behaviour. To develop a good simulation is a difficult task and many plant data and much time are needed together with a good technical knowledge of the plant. It is possible to describe the simulation procedure through these three principal steps:

- definition of the flowsheet
- definition of the operative variables
- choice of the thermodynamic model

In the former it is necessary to choose the streams that must be included in the model. The choice to include in the model all the process streams as represented in Fig. 1 makes the simulation work more complicated because in a real plant it is usual to measure only a few selected variables of the streams of particular interest for the production scope. Thus it is impossible that all the streams are perfectly characterized. To overcome this problem it is necessary to refer to indications of the plant operators and of course to make a series of simulation tests to well understand the behaviour of the undefined streams on the model performance.

Regarding the second point we start from the analysis of the reconciliated plant data. Temperatures, pressures and flow rates were collected every 12 minutes for a month and the period of time in which these parameters were constant was selected to obtain a mean value of the observed parameter to utilize in the simulation.

Another important input data required for the simulation model is the crude oil characterization. It is know that the oil is a mixture of so many components that is not possible to make a detailed classification based in terms of chemical compounds. For this reason the crude is usually specified by

means of distillation curves obtained by distilling a crude sample. In our work the True Boiling Point (TBP) curve is used. The accuracy of the property prediction strongly depends on the accuracy of the TBP curve used [12-14]. In many refineries it is often available only the crude assay, but to obtain a good simulation a more detailed TBP curve is necessary and moreover also the crude assay could not represent the crude processed in the time of the observation. The difference in the real TBP and the assay data available in the refinery data base can be due to the blending of different crude, stratification or contamination of the crude with another one in the storage tank [15]. Moreover to simulate real crude distillation unit it is better do not use the TBP implemented in the simulation package, but always utilize plant data. This because the quality of the same crude can change during the years or as a function of the point of extraction also if it comes from the same oilfield. In this work we utilized the TBP curve reported in Fig. 2, obtained by sampling the processed crude.

The quality of the side stream products is specified by the ASTM D86 distillation curves obtained from the plant laboratory in the period of time selected [16].

Another important parameter to set is the plate efficiency of the main column; obviously a direct measure is not available and we estimated this data starting from empirical correlations [17,18] and using it as a tuning parameter in the sensitivity analysis performed to match the thermal profile of the column and the composition of the side streams obtained from the plant. To perform this analysis it was necessary to divide the whole column in different sections in coincidence with the variations of the liquid or vapour flow rates corresponding to the pumparounds or the side strippers locations. Table 1 reports the column sections and the efficiencies obtained by fitting the plant data.

To choose the thermodynamic model we checked the following three, usually recommended [19] for petrochemical plants operating at low or medium pressure:

- BK10
- Chao-Seader

- Grayson-Streed

For all models no significant difference was observed in the prediction of the streams characteristics and so the Grayson-Streed method was utilized in all the simulations.

Figs. 3-5 report the comparison between the plant and the simulated data for products and reflux flow rates, main column temperature profile and Kero and GAL qualities. As can be seen a good data agreement with a maximum error of 3% was obtained, confirming the possibility to use the model for analysis and retrofit purposes.

ACCEPTED MANUSCRIPT

4. The preflashing devices options

The different preflash devices can be grouped in two main typologies: preflash drums and preflash towers/columns. The choice between the two types depends on the scope of the revamping work and on the space constrictions of the plant. Usually preflash drums are preferred when it is necessary to increase the capacity of the plant, while preflash towers are preferred to improve the naphtha-kerosene separation, in some cases both can improve the heat integration of the plant [20]. The main types of device are:

- high or low pressure preflash drum
- preflash tower with naphtha stripper
- preflash tower with multiple products
- preflash tower with reboiler
- preflash tower and atmospheric tower with shared reflux

Sloley [20] gives a detailed description of each system highlighting advantages and disadvantages of every device. In this work we consider two alternatives; a column with naphtha product and a flash drum operating at the same pressure of the main column. These alternatives can be considered as the simplest options for a revamping project and are the more applicable solutions considering the plant layout. The principal characteristics of these two solutions and the results obtained from the simulations are discussed and compared in the followings paragraphs.

4.1. Preflash drum

The preflash drum is the simplest device to separate light crude compounds before the feed inlet to the main column. This device consists of a simple vessel sized for a mean residence time of about 15-20 minutes to assure a good separation between the liquid and the vapour phase [10]. Particular attention is required during the design to avoid the entrainment of the unflashed liquid crude in the vapour stream. A few useful indications about the principal geometric dimension of the drum can be found in the Feintuch work [5].

In our case considering the layout of the plant the only possible location for the preflash device is just before the furnace and its temperature is that at the exit of the heat exchanger network.

Thus, all the simulations were made with a preflash temperature of 230°C and with the same pressure of the main column. Another parameter to set is the optimal feed location of the flashed vapour in the main column. There are different possibilities; the most intuitive is to feed the stream just in the tray where the end points of the flashed vapour and of the internal liquid are equal; however in the case of flashed crude entrainment in the vapour stream, there is the risk to obtain black distillates below the feed location [10]. This practical consideration forces the choice to feed the flashed vapour in the flash zone. The flowrates of the main streams and of the furnace duty obtained in our case considering the system with the flash drum are reported in Table 2 together with those obtained for the preflash column and the original plant design.

4.2. Preflash column

The preflash column, differently from the preflash drum, realizes an effective separation and it is possible to set the cut point of the desired product. There are some reported cases of refineries which use a preflash column in their plant or consider this device in a revamping project to unload the

atmospheric furnace, to eliminate vaporization at the furnace inlet control valves, to increase the naphtha production and to debottleneck the crude column overhead system [21, 22].

In our case we consider a bottom steam column with 12 stages and a single liquid product drawn from the condenser. Obviously, from the preflash column condenser, also part of the fuel gas is removed.

The main problems of the preflash column are related to the presence of only a few plates between the inlet and the withdrawn and to the high reflux ratio flow rate [20]. Another aspect to consider is the naphtha reduction in the top of the main column. So, if we want to keep the same end point for the naphtha stream, the top temperature decreases with possible condensation phenomena and consequent corrosion possibility. Usually it is better to assure a sufficient column top temperature to avoid corrosion and a long time running apparatus. In our case we choose to fix the top temperature value higher than 100°C. The results obtained with this configuration are reported in Table 2.

5. Preflash devices comparison

The comparison of the devices performances are made according to three principal aspects: the distillate flowrates; the product quality and the potential in energy reduction.

From the Table 2 it is possible to note that employing the preflash drum there is a lower naphtha production, and a higher Kero, LGO and residue flowrates, while the amount of HGO is unchanged compared to the plant design case. These results are obtained increasing the outlet furnace temperature of 5°C to compensate the quench effect of the flashed vapours that are colder than the heated crude from the furnace. The bottom steam flowrate was also increased to compensate the lower carrier effect of the light compounds removed. The increase of the steam flowrate is limited from flooding considerations. In the preflash column case it is evident the high increase in the production of the total

naphtha compared to the plant design. As a drawback there is a decrease of the Kero production and the increase of the residue stream flowrate.

The second aspect considered is the improvement of the separation quality. For petrochemical systems where it is not possible to give a discrete component specification, the quality of the separation can be measured by the temperature difference between the 95% vol. and the 5% vol. of the ASTM D86 of two consecutive products [23]. In the plant design the temperature difference between the naphtha and the kerosene products is equal to 1.76, while a gap of 3.10 for the preflash drum design is observed.

This value is improved to 16.32 in the preflash column configuration.

The comparison of the devices from an energetic point of view, can be done through an energetic index (E), defined as the normalized ratio between the furnace duty and the feed flow rate, the values for each configuration are reported in Fig. 6. It is possible to notice that the preflash drum realizes the highest energy reduction whereas the preflash column energy consumption is nearly the same of the plant design.

In order to quantify the economy of the proposed configurations it is possible to define another index (P) obtained normalizing, with respect to the plant design case, the balance reported in eq. 1 for each preflash device considered. The balance considers the cost of the fuel oil employed in the furnace and the main column stripping steam together with the value of the two main distillates product streams.

value of Kero production + value of naphtha production - fuel oil consumption - steam consumption = P
(1)

The results obtained are presented in Fig. 6 considering a fuel oil density of 973.7 kg/m^3 with a lower heating value of 9767 kcal/kg . The average prices for the streams are taken from the literature[24]. The results obtained show that the preflash column is able to outperform the plant design while the preflash drum, though realizes an higher energy reduction, is penalized for the less naphtha yield.

6. Conclusions

Two revamping solutions for an industrial Crude Distillation Unit are considered in order to identify the better solution to decrease the high energy consumption of the plant. Both a preflash drum and a preflash column were considered and compared for energy savings. The utilization of one of them corresponds to different plant specifications. The preflash drum is the simplest device for scope of energy reduction, but some precaution must be considered. First the possibility of crude foaming limits the flashed vapour feed location in the main column. Further there is a quench effect of the cold vapour from the preflash drum and a reduction of the carrier effect due to the light compounds. However the main advantages from the implementation of this solution are the furnace duty reduction and the increased production of the middle distillate. The preflash column operates a preliminary separation and it is not required any re-feed in the main column. A high increase of light distillate flow rates can be obtained but it results in smaller energy savings in the furnace duty compared to those of the preflash drum configuration. Performing a first evaluation of the cost related to the less furnace load together with the variation of the production asset, the preflash column is able to achieve better performance than the preflash drum. Anyway these two options must be considered together with the different market requirements. If the price of the light distillates is low, it can be convenient to reduce their production and improve the production of middle distillate. In this case the preflash drum could be the best solution to reach considerable savings in the energy demands. Instead, if the plant production requires a high naphtha production with a high separation performance between this and the Kero stream, the preflash column should be preferred. In both cases the energy savings obtainable are related to a reduction in light or middle distillate yield.

References

- [1] M. Bagajewicz, S. Ji, Rigorous procedure for the design of conventional atmospheric crude fractionation units. Part I: Targeting, *Ind. Eng. Chem. Res.* 40 (2001) 617-626.
- [2] B. Linhoff, E. Hindmarsh, The pinch design method for heat exchanger networks, *Chem. Eng. Sci.* 38 (1983) 745-763.
- [3] A.J. Brugma, The Brugma process, *Ref. Nat. Gasoline Manuf.* 20 (1941) 86-88.
- [4] W.D. Harbert, Preflash saves heat in crude unit, *Hyd. Proc.* July (1978) 123-125.
- [5] H.M. Feintuch, V. Peer, M.Z. Bucukoglu, A preflash drum can conserve energy in a crude preheat train, *Energy Prog.* 5 (1985) 165-172.
- [6] R. Yahyaabadi, Rethink placement of preflash drum in crude preheat train network, *Hydrocarbon Process.* 85 (2006) 78-84.
- [7] R. Yahyaabadi, Solving hydraulic problems in crude preheat train networks, *Hydrocarbon Process.* 84 (2005) 89-95.
- [8] S. Waintraub, R. Campos Cauby Coutinho, R. Oliveira Esposito, Preflash drum when processing heavy oils: paradox or reality?, *AIChE Spring National Meeting*, (2007), Houston, Texas, 22-27 April.
- [9] S. Ji, M. Bagajewicz, Design of crude fractionation units with preflashing or prefractionation: energy targeting, *Ind. Eng. Chem. Res.* 41 (2002) 3003-3011.
- [10] S.W. Golden, Prevent preflash drum foaming, *Hydrocarbon Process.* 76 (1997) 141-153.
- [11] S. Ji, M. Bagajewicz, Design of crude distillation plants with vacuum units. I. Targeting, *Ind. Eng. Chem. Res.* 41 (2002) 6094-6099.
- [12] C.H. Whitson, Characterization hydrocarbon plus fractions, *Soc. Petrol. Eng. J.* August (1983) 683-694.
- [13] M.R. Riazi, A continuous model for C7+ fraction characterization of petroleum fluids, *Ind. Eng. Chem. Res.* 36 (1997) 4299-4307.

- [14] G.R. Vakili-Nezhaad, H. Modarress, G.A. Mansoori, Continuous thermodynamics of petroleum fluids fractions, *Chem. Eng. Process.* 40 (2001) 431-435.
- [15] S. Bath, T. Chatterjee, D.N. Saraf, On-line data processing and product properties prediction for crude distillation units, *AIChE Spring National Meeting*, (2003), New Orleans, Louisiana, March 30-April 3.
- [16] A. Saliu, R. Baratti, S. Melis, Data analysis in modelling distillation crude units, *ICheaP-5*, (2001), Florence, May 20-23.
- [17] S.A. MacFarland, P.M. Sigmund, M. Van Winkle, Predict distillation efficiency, *Hydrocarbon Process* 51 July (1972) 111-114.
- [18] B.M. Jacimovic, S.B. Genic, Use a new approach to find Murphree tray efficiency, *Chem. Eng. Prog.* August (1996) 46-51.
- [19] Aspen Plus 13.0 User Models, Aspen Technology, Inc., 2007.
- [20] A. Sloley, Crude petroleum distillation, The Distillation Group, Inc. (2002).
- [21] G.R. Martin, Keeping down the cost of revamp investment, *PTQ Summer Issue* (1999) 99-107.
- [22] T. Barletta, G.R. Martin, A. Visser, Consider comprehensive CPD efforts to cut costs, *Hydrocarbon Process.* 81 (2002) 53-62.
- [23] D.S.J. Jones, *Elements of petroleum processing*, John Wiley & Sons Ltd., England, 1995.
- [24] Energy Information Administration, *Petroleum marketing monthly*, March 2008.

Figure Captions

Fig. 1. Crude Distillation Unit configuration.

Fig. 2. TBP curve of the processed crude.

Fig. 3. Flow-rate comparison between the plant and the simulated data.

Fig. 4. Temperature profile of the main column.

Fig. 5. Comparison between plant (solid symbols) and simulated (open symbols) ASTM D86 data for GAL (upper) and Kero (lower) streams.

Fig. 6. Energetic (E) and production (P) index for the plant design (empty bars), preflash drum (vertical lines) and preflash column (horizontal lines).

ACCEPTED MANUSCRIPT

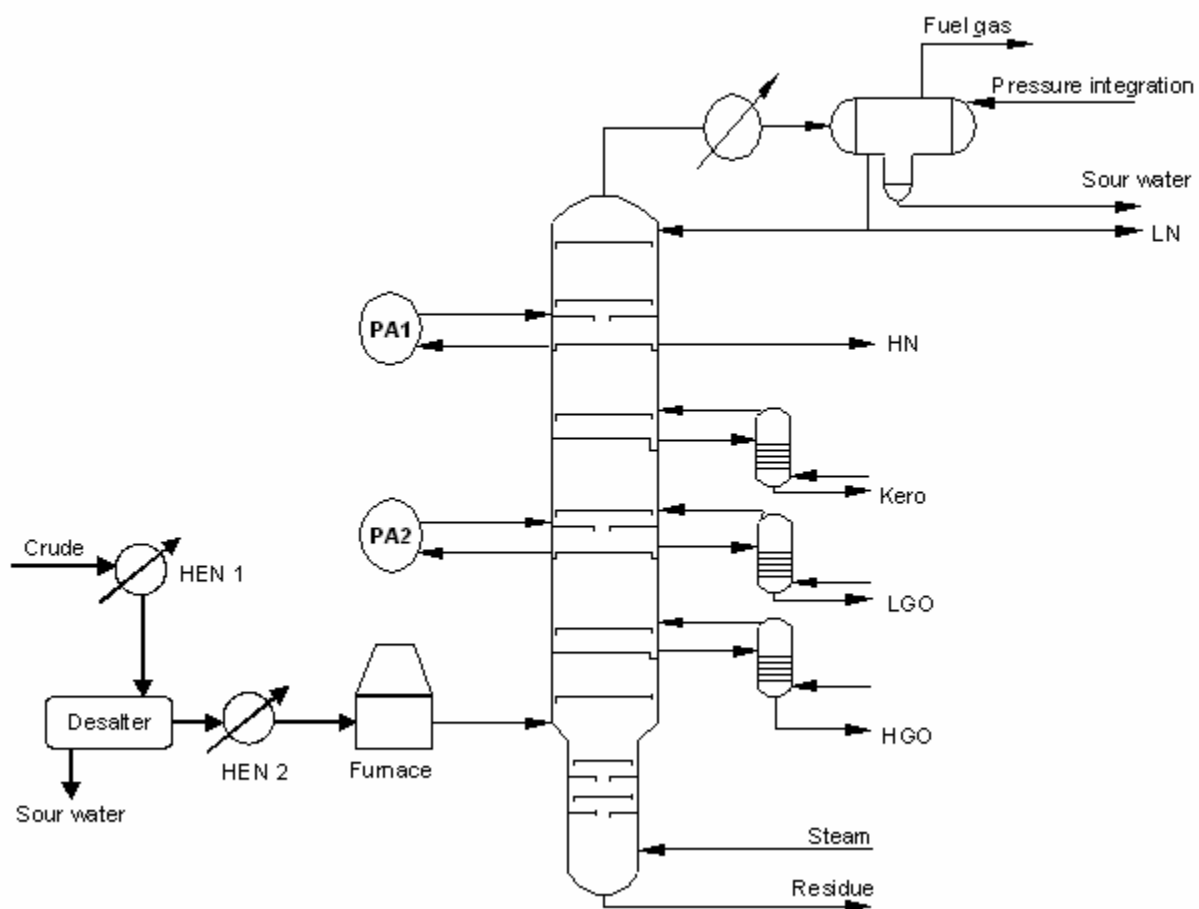

Figure 1

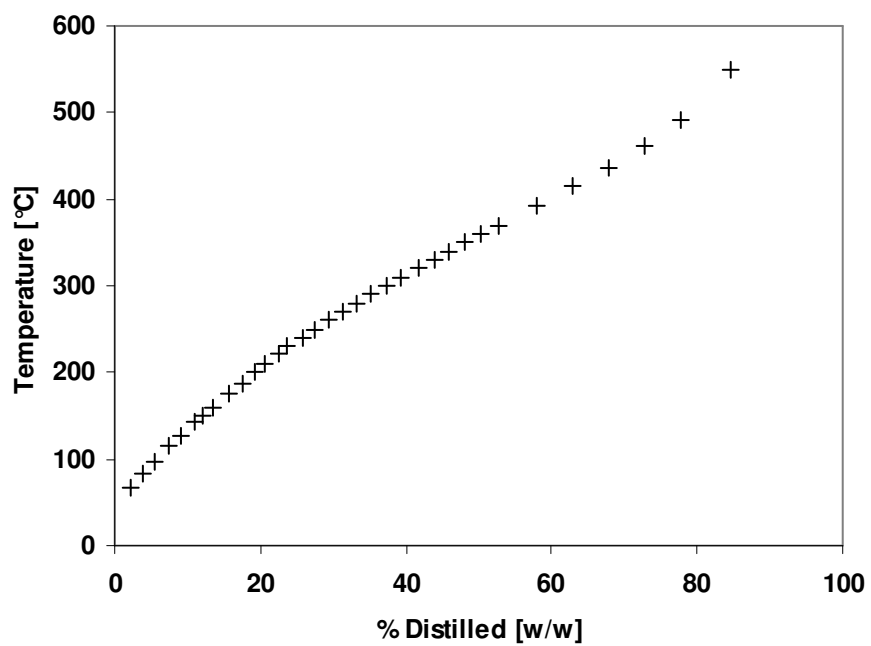

Figure 2

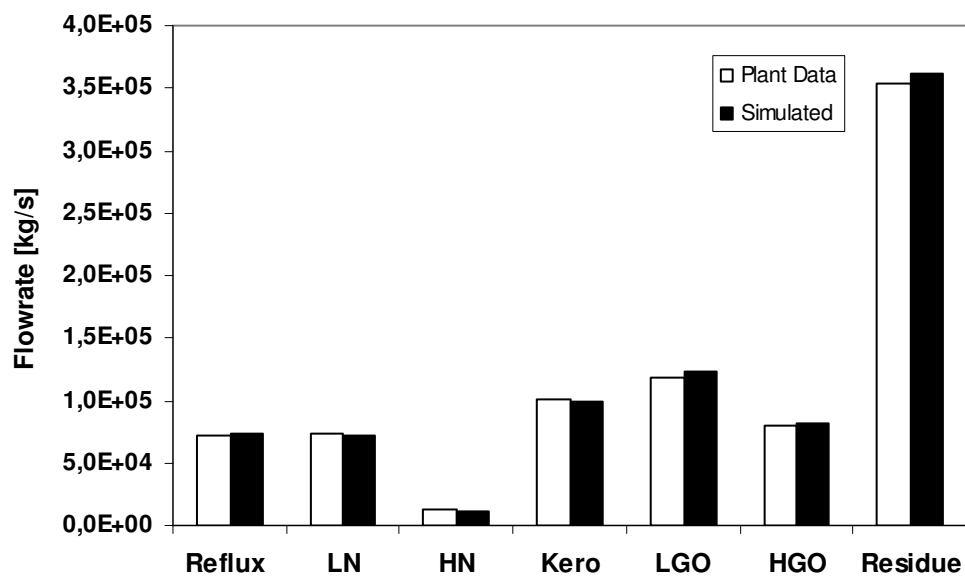

Figure 3

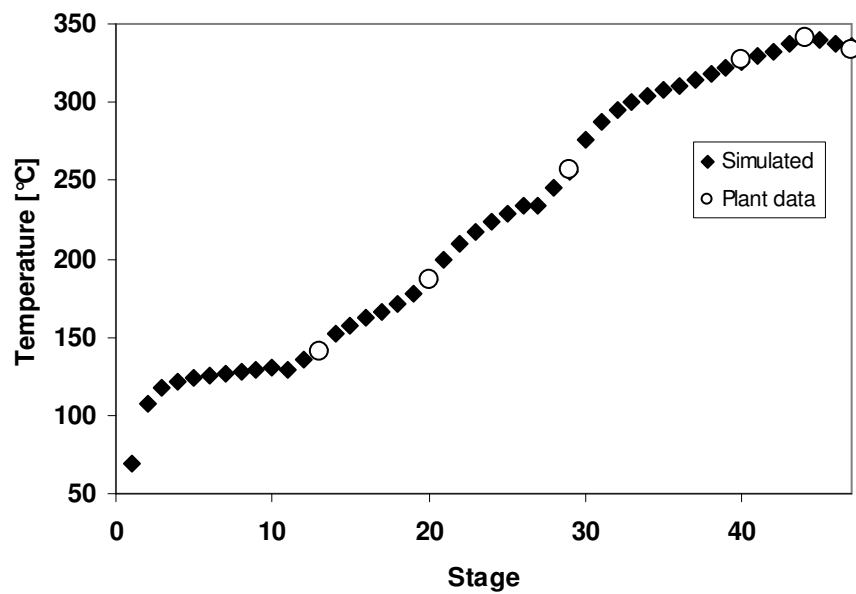

Figure 4

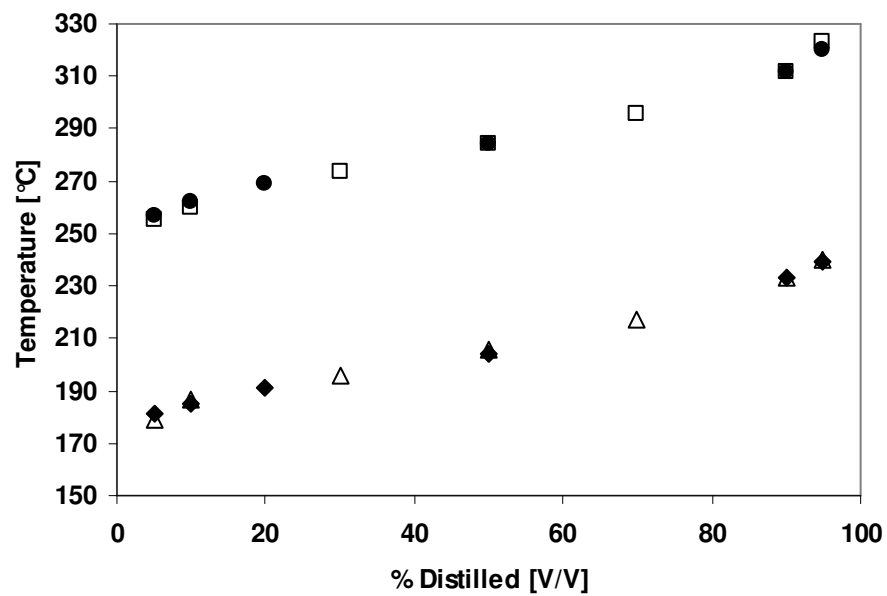

Figure 5

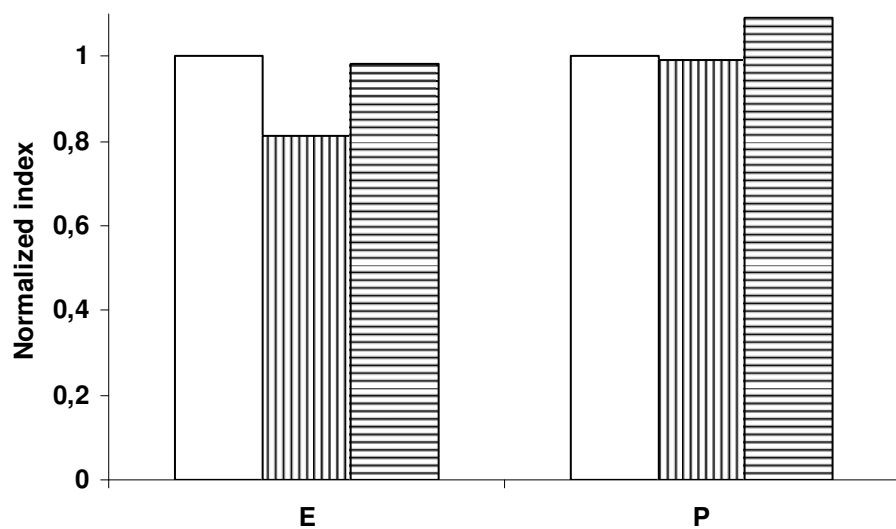

Figure 6

ACCEPTED MANUSCRIPT

Tables

Section	Starting stage	Ending stage	Efficiency
1	2	11	0.9
2	12	13	0.25
3	14	27	0.8
4	28	29	0.25
5	30	34	0.8
6	35	47	0.5

Table 1: Section stages and efficiency of the main column

ACCEPTED MANUSCRIPT

Flowrate [kg/h]	Plant Design	Preflash Drum	Preflash Column
Naphtha	84195	79637	117018
Kero	100000	101186	82715
LGO	124000	124422	124000
HGO	82000	82000	82000
Residue	361496	364404	363937
Furnace Duty [kcal/h]	80821092	65231158	79489549

Table 2: Comparison between the original plant design, the preflash drum and the preflash column

ACCEPTED MANUSCRIPT