



HAL
open science

Simulation and Performance Evaluation of Finned-Tube CO Gas Coolers for Refrigeration Systems

Y.T. Ge, R.T Cropper

► **To cite this version:**

Y.T. Ge, R.T Cropper. Simulation and Performance Evaluation of Finned-Tube CO Gas Coolers for Refrigeration Systems. Applied Thermal Engineering, 2009, 29 (5-6), pp.957. 10.1016/j.applthermaleng.2008.05.013 . hal-00595946

HAL Id: hal-00595946

<https://hal.science/hal-00595946>

Submitted on 26 May 2011

HAL is a multi-disciplinary open access archive for the deposit and dissemination of scientific research documents, whether they are published or not. The documents may come from teaching and research institutions in France or abroad, or from public or private research centers.

L'archive ouverte pluridisciplinaire **HAL**, est destinée au dépôt et à la diffusion de documents scientifiques de niveau recherche, publiés ou non, émanant des établissements d'enseignement et de recherche français ou étrangers, des laboratoires publics ou privés.

Accepted Manuscript

Simulation and Performance Evaluation of Finned-Tube CO₂ Gas Coolers for Refrigeration Systems

Y.T. Ge, R.T Cropper

PII: S1359-4311(08)00221-4
DOI: [10.1016/j.applthermaleng.2008.05.013](https://doi.org/10.1016/j.applthermaleng.2008.05.013)
Reference: ATE 2507

To appear in: *Applied Thermal Engineering*

Received Date: 18 January 2008

Revised Date: 1 May 2008

Accepted Date: 11 May 2008

Please cite this article as: Y.T. Ge, R.T Cropper, Simulation and Performance Evaluation of Finned-Tube CO₂ Gas Coolers for Refrigeration Systems, *Applied Thermal Engineering* (2008), doi: [10.1016/j.applthermaleng.2008.05.013](https://doi.org/10.1016/j.applthermaleng.2008.05.013)

This is a PDF file of an unedited manuscript that has been accepted for publication. As a service to our customers we are providing this early version of the manuscript. The manuscript will undergo copyediting, typesetting, and review of the resulting proof before it is published in its final form. Please note that during the production process errors may be discovered which could affect the content, and all legal disclaimers that apply to the journal pertain.

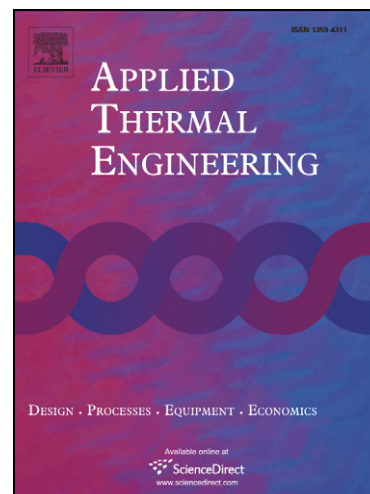

Simulation and Performance Evaluation of Finned-Tube CO₂ Gas Coolers for Refrigeration Systems

Y.T. Ge^{a,*}, R. T Cropper^b

^a Mechanical Engineering, School of Engineering and Design ,Brunel University
,Uxbridge, Middlesex , UB8 3PH, UK

^b Formerly School of Engineering, North East Wales Institute, Plas Coch Campus, Mold
Road, Wrexham, L11 2AW, UK

Abstract

This paper describes a detailed mathematical model and its application for air-cooled finned-tube CO₂ gas coolers. The model has been developed utilizing a distributed method which is necessary to predict accurately the great variation of both refrigerant thermophysical properties and local heat transfer coefficients during CO₂ gas cooling processes. The modelling method also enables performance analyses with different circuit arrangements and changed structure parameters in gas coolers to be assessed. The model has been validated with the test results from a published literature by

comparing the gas temperature profiles along the coil pipes from refrigerant inlet to outlet at different operating states. With the aim of increasing the heat capacity or minimizing the approach temperature for a gas cooler, the validated model is used to carry out performance simulation and analysis when the circuit arrangement of the original heat exchanger is redesigned. It is found that the approach temperature and the heat capacity are both improved with the increase of heat exchanger circuit numbers.

Key Words: model, CO₂, gas cooler, simulation and validation, performance analysis.

Nomenclature

A	area (m ²)		<i>Subscripts</i>
C _p	specific heat at constant pressure (J kg ⁻¹ K ⁻¹)	a	air
C	capacity rate (W K ⁻¹)	f	friction
d	diameter(m)	h	hot side
D	depth (m)	<i>i</i>	inner, <i>i</i> th grid
f	friction factor	<i>j</i>	<i>j</i> th grid
G	mass flux (kg m ⁻² s ⁻¹)	<i>k</i>	<i>k</i> th grid
h	enthalpy(J kg ⁻¹)	min	minimum
H	height (m)	max	maximum
<i>i, j, k</i>	coordinates	o	outer
<i>m</i>	mass flow rate (kg s ⁻¹)	r	refrigerant

P	pressure (Pa)	w_i	inner pipe wall
\dot{q}	heat transfer per square meter (W m^{-2})		
\dot{Q}	heat transfer (W)		
R	resistance (K W^{-1})		
s	perimeter of inner pipe (m)		
T	temperature (K)		
u	velocity (m s^{-1})		
U	overall heat transfer coefficient ($\text{W m}^{-2} \text{K}^{-1}$)		
V_a	air velocity (m s^{-1})		
W	width (m)		
z	length (m)		

Greek symbol

α	heat transfer coefficient ($\text{W m}^{-2} \text{K}^{-1}$)
η	efficiency
Δ	difference
ρ	density (kg m^{-3})
τ	shear stress (N m^{-2})
ε	effectiveness

1. Introduction

Carbon dioxide (CO_2), as a natural refrigerant, has been attracting more and more attention in the applications involving refrigeration, heat pump and

air conditioning systems. Compared with the conventional refrigerants like R22, R134a and R404A etc., CO₂ is more environmentally friendly with zero Ozone-Depleting Potential and very low direct Global Warming Potential. The CO₂ refrigerant has also favourable thermophysical properties like higher values of density, latent heat, specific heat, thermal conductivity and volumetric cooling capacity, and lower value of viscosity. However, CO₂ refrigerant has a quite high operating pressure because of its low critical temperature (31.1 °C) and high critical pressure (73.8 bar). In a CO₂ refrigeration system when heat is rejected to ambient air at temperatures close to or above 31.1 °C, the critical temperature of CO₂, the refrigeration cycle is said to operate in a transcritical mode. The conventional air cooled condenser is therefore replaced with a gas cooler. As a main component of a

CO₂ transcritical refrigeration system, the gas cooler's performance greatly affects a system's efficiency and is thus worthy of further investigation.

In its simplest form a transcritical CO₂ cycle is thermodynamically less efficient compared with a conventional vapour-compression cycle [1]. Bullock [2] compared the performance of a CO₂ transcritical cycle with a R22 system for an air conditioning application. He found that CO₂ systems were less efficient than R22 systems by 30% in the cooling mode. Similar conclusions were obtained by Robinson and Groll [3] and Aarliien and Frivik [4]. The operating efficiency for the CO₂ system can however be improved through the use of an expansion turbine, a liquid-line/suction-line heat exchanger (llsl-hx), and significant performance improvements in system equipment such as compressor, evaporator or gas cooler. In CO₂ refrigeration system

with a transcritical cycle, at fixed refrigerant gas cooler outlet temperature and evaporating temperature, there is an optimum high-side pressure such that the cooling COP in the system can reach a maximum [5-7]. The refrigerant high-side pressure can be controlled by adjusting the back (high-side) pressure of the installed expansion valve in the system [1]. It is known that at a constant evaporating temperature the maximum cooling COP is increased greatly with lower refrigerant temperature at the gas cooler exit. The temperature difference between the refrigerant outlet and incoming ambient air is called approach temperature (AT) for an air-cooled gas cooler. The minimization of the approach temperature will greatly affect the system efficiency [8] this being mainly dependent on the optimal design of the heat exchanger. Consideration of circuit arrangements and structural parameters will affect the optimal

design for the heat exchanger, an efficient and economic way to effect this analysis is to utilize the simulation technique.

In CO₂ transcritical cycles, finned-tube gas coolers are not as popular as aluminium minichannel heat exchangers which have advantages of less risk of high pressure stresses, light weight and compactness and are widely used in automobile air conditioning. Therefore, a great deal of research and development effort has been put into minichannel heat exchangers [9-11]. However, because of the lower cost, the finned-tube coils are still believed as competent types of gas coolers. Theoretically three modelling methods could be used in the performance analysis of such gas coolers, ϵ -NTU or LMTD i.e. lumped method, tube-in-tube, and distributed method. Since there is rapid change of the CO₂ thermophysical properties with

temperature during an isobaric gas cooling process, it is not practical to use the ε -NTU or LMTD method to simulate gas coolers [12]. The tube-in-tube method developed from the research of Domanski [13,14] was utilized in the simulation of a gas cooler by Chang and Kim [15]. By means of the model simulation, the effects of some coil structural parameters on the performance of the gas cooler were investigated. It was found from the simulation results that the approach temperature can be decreased with increased heat exchanger front area. Although a significant modelling improvement can be realized by this method, a more detailed modelling strategy, distribution method, is still expected to further enhance the simulation accuracy and therefore obtain more reliable conclusions. Due to higher simulation accuracy, the distributed method has been widely

used in modelling the finned-tube air cooling evaporators and air cooled condensers. A distributed computational model for the detailed design of finned coils (condensers or evaporators) has been developed by Bensafi et al [16]. The model can simulate the finned coils with non-conventional circuits, non-uniform air distribution and different structures of pipes and fins. However, the correlations used in the calculations of heat transfer coefficients and pressure drops for both refrigerant and air need be updated. In addition, the types of refrigerants applied to the model need be enhanced. Similarly, the air-cooled condensers were modelled with the distributed method by Casson et al [17]. The model can be used in optimal design of the internal circuits of the heat exchangers and performance comparison with R22 and its HFC substitutes. This model was used by Zilio et al [18] to validate the

experimental research for CO₂ gas coolers and a systematic deviation was realised. The suitable correlations to predict CO₂ heat transfer coefficients were therefore tested. Recently, a simulation and design tool to carry out optimal design and performance analysis for the air to refrigerant heat exchangers, called CoilDesigner, was introduced by Jiang et al [19]. Apart from the powerful design and simulation functions due to utilise the distributed method, the design tool has an advanced user friendly interface to deal with the pre and post simulation processes. However, the iteration methods for both refrigerant and air sides haven't presented in the paper. The distributed method was used in a gas cooler model by Sarkar et al [20] but the heat exchanger was the type of water cooled double pipe. To the authors' knowledge, in the public literatures, it is hardly found that a gas

cooler model has been developed using the distributed method. Although the fundamental conservation equations used in each coil element can be the same when using the distributed method to set up the models, the simulation results could be largely different. The main reasons are the different assumptions when using the conservation equations, the various correlations of heat transfer coefficients and pressure drops for both refrigerant and air sides, and also the diverse solving and iteration methods used in the models.

This paper describes the mathematical modelling of a finned-tube air-cooled CO₂ gas cooler by means of distributed method. The update correlations of heat transfer coefficients and pressure drops for both refrigerant and air sides are utilised. An efficient solving method is proposed in the simulation. The model is validated

with the test results from published literature. The validated model is then utilized to explore the potential for improved designs of gas coolers to achieve the minimum approach temperature and maximum system operating efficiency.

2. Model descriptions

The distributed method is used in developing the simulation model of finned-tube air-cooled CO₂ gas coolers. A diagram with sub elements of the coil in three-dimensional (3-D) space for the model is schematically drawn in Figure 1. Tubes are arranged parallel to i direction, j is specified in the longitudinal direction, while k is in the transverse direction. Air is flowing parallel to j direction and refrigerant is assumed in approximate counter-cross direction to air for this sample. The selection of the number of small

elements in i direction is arbitrary from one to infinity. The larger this value is, the more accurate the simulation will be, but expensive computing time will be sacrificed. The coordinate of each divided element in the 3-D space can then be determined. The coordinate value i represents the number of sub-elements for each pipe, selected by the model, j corresponds to pipe numbers in longitudinal paths starting from the air inlet, while k equals the tube numbers in the transverse path originating from the bottom. Therefore, the state point of either refrigerant or air at each specified sub-element in the 3-D space can be positioned with its corresponding coordinate values i , j and k , which vary according to the circuit number and pipe number. The pipe number starts from refrigerant inlet to refrigerant outlet for each circuit. The solving routine firstly starts from the circuit loop if there is more than one circuit for the coil. For

each circuit, the simulation will run through each numbered pipe starting from refrigerant inlet and then the element loop for each pipe. The whole modelling work depends on setting up the conservation equations for each sub-element and an efficient routine to solve these equations. The solutions for one sub-element can be used as the inputs for the next sub division. The air side parameters for each element which are normally unknown initially will be firstly assumed. These parameters will be updated by next time iteration. The total heating load of the gas cooler is calculated at the end of each iteration. The iteration will carry on until all the loops are cycled and the total heating loads for two continuous iterations are nearly not changed.

2.1 Refrigerant side conservation equations

Before setting up the refrigerant side conservation equations for each element, the following assumptions are proposed:

- System is in steady state.
- No heat conduction in the direction of pipe axis and nearby fins.
- Air is in homogeneous distribution, that is, air-facing velocity to each element is the same.
- No contact heat resistance between fin and pipe.
- Refrigerant at any point in the flowing direction is in thermal equilibrium condition.

Mass equation:

$$\frac{d}{dz}(\dot{m}_r) = 0 \quad (1)$$

Momentum equation:

$$\frac{1}{A_i} \frac{d}{dz}(\dot{m}_r u) = -\frac{dP}{dz} - \frac{\tau_{wi} s_{wi}}{A_{wi}} \quad (2)$$

Energy equation:

$$\frac{d}{dz}(\dot{m}_r h) = -(\pi d_o) \dot{q} \quad (3)$$

$$\text{where, } \Delta P_f = f \frac{G^2 \Delta z_i}{2\rho d_i} \quad (6)$$

The above equations can be easily discretized as below for a sub-element shown in Figure 1 with coordinate from (i, j, k) to $(i+1, j, k)$. The dimensions of the sub-element at (i, j, k) directing to i, j, k are $\Delta z_i, \Delta z_j$ and Δz_k respectively.

Mass equation:

$$\dot{m}_r \Big|_{(i+1, j, k)} - \dot{m}_r \Big|_{(i, j, k)} = 0 \quad (4)$$

Momentum equation:

$$\frac{1}{A_i} [(\dot{m}_r u) \Big|_{(i+1, j, k)} - (\dot{m}_r u) \Big|_{(i, j, k)}] = -\Delta P - \Delta P_f \quad (5)$$

Energy equation:

$$(\dot{m}_r h) \Big|_{(i+1, j, k)} - (\dot{m}_r h) \Big|_{(i, j, k)} = -(\pi d_o) \dot{q} \times \Delta z_i \quad (7)$$

The conservation equations can also be applied for the airside calculation. The pressure drop calculation is used instead of the momentum equation and heat transfer calculation is included in the energy equation for this side. In addition, there is a heat balance between the air and refrigerant sides for each element.

Fig. 1. Three-dimensional coordinate of sub elements in the coil for the gas cooler model

2.2 Airside Heat Transfer

NTU- ε method is used in the calculation of heat transfer for airside in one grid section.

$$\dot{Q}_a = \varepsilon C_{\min} [T_r(i, j, k) - T_a(i, j, k)] \quad (8)$$

where the effectiveness ε is calculated as below:

$$\varepsilon = 1 - \exp\left(-\gamma \frac{C_{\max}}{C_{\min}}\right) \quad \text{for } C_{\max} = C_h$$

$$\text{where } \gamma = 1 - \exp\left(-\frac{UA}{C_{\max}}\right) \quad (9)$$

and,

$$\varepsilon = \frac{C_{\max}}{C_{\min}} (1 - \exp(-\gamma \frac{C_{\min}}{C_{\max}})) \quad \text{for } C_{\min} = C_h$$

$$\text{where } \gamma = 1 - \exp\left(-\frac{UA}{C_{\min}}\right) \quad (10)$$

The product UA (overall heat-transfer coefficient times area) can be calculated as:

$$UA = \left(\frac{1}{\alpha_a \eta_0 A_0} + \sum R_i + \frac{1}{\alpha_r A_r}\right)^{-1} \quad (11)$$

where $\sum R_i$ is the sum of heat conduction resistances through the pipe wall and fin.

The heat transfer from airside can be calculated as:

$$\begin{aligned} \dot{Q}_a &= \dot{m}_a(i, j, k) \times C_{p_a}(i, j, k) \times [T_a(i, j+1, k) \\ &\quad - T_a(i, j, k)] \\ &= UA(i, j, k) \times [T_r(i, j, k) - T_a(i, j, k)] \end{aligned} \quad (12)$$

The parameters at grid points $(i+1, j, k)$ for refrigerant and $(i, j+1, k)$ for air can be obtained when equations (4) to (12) are solved together.

The accurate model prediction also relies on the precise calculations of fluid properties, heat transfer coefficients and pressure drops in both refrigerant and air sides. The CO₂ refrigerant properties are calculated using subroutines from the National Institute of Standards and Technology software package REFPROP [21]. For calculating the refrigerant heat transfer coefficient, the

correlation from Pitla et al. is utilized [22]. The friction pressure drop is calculated in equation (6) and the Blasius equation [23] is used to calculate the friction factor f . The air side heat transfer and friction coefficients are computed using the correlations by Wang et al [24] [25].

3. Model validations

To develop a performance database for the component design in CO₂ transcritical cycle, a special designed test facility was set up by Hwang et al. [26]. The test system was composed of an air duct and two environmental chambers that house an evaporator, a gas cooler, an expansion valve and a compressor. By means of this test rig, a set of parametric measurements at various inlet air temperatures and velocities, refrigerant inlet temperatures, mass flow rates and

operating pressures were carried out on a specified CO₂ gas cooler. The side view of the circuit arrangement for the tested gas cooler is shown in Figure 2. The air flow is from right to left and refrigerant inlet is at the upper left numbered with “0” and the refrigerant outlet is at the lower right numbered with “54” for the heat exchanger. The dash lines in the Figure indicate the U-bends of the rear side noted with odd numbers, while the solid lines signify the U-bends of the front side noted with even numbers. To measure the variation of refrigerant temperature along the heat exchanger pipes, numbers of thermocouples were attached on the outside surfaces of the front side U-bend pipes and at refrigerant inlet and outlet as well. These thermocouples were well insulated to get more accurate measurement. The structural specification of the gas cooler is listed in Table 1.

Fig. 2. Tested gas cooler (Coil A) with numbered pipes

The test conditions, 36 in total, are listed in Table 2. Each test condition contains the measurements of air inlet temperature, air velocity, refrigerant inlet temperature, refrigerant inlet pressure and refrigerant mass flow rate. These measurements and the coil structural parameters will be used as model inputs and parameters respectively. The predicted refrigerant temperature profile at each test condition is therefore compared with the corresponding test result in order to validate the model. To save space, comparison results for twelve test conditions with numbers 1 to 3, 10 to 12, 19 to 21 and 25 to 27, listed in Table 2 are selected and shown in Figure 3 to

6 respectively. It is seen from both simulation and test results that a sharp refrigerant temperature decrease occurs in the third pipe row ($j=3$), pipes numbered from 0 to 18 in Figure 2. The temperature changing rates in the second ($j=2$) and first rows ($j=1$) are gradually reduced. In addition, at constant refrigerant pressure and mass flow rate, similar refrigerant inlet temperature and unchanged air inlet temperature, refrigerant temperature at any specified location is always lower for higher front air velocity. This is because that the heat transfer is enhanced with higher front air velocity. The predicted refrigerant temperature profile for each test condition matches

fairly well with that of test result. For all the test conditions, the refrigerant temperatures at the gas cooler outlet are predicted and compared with those of test results, as shown in Figure 7. The temperature discrepancies between simulation and the test results for refrigerant outlet temperatures are mostly within ± 2 °C when air front

velocity is above 1m/s. The bigger errors are predominantly caused when the air front velocity is at 1m/s. The correlation of airside heat transfer coefficient at lower air velocity needs therefore be further revised. It is concluded that the simulation can fairly represent the test results and the model is therefore validated.

Table 1 Specification of the tested gas cooler

Table 2 Test conditions

Fig. 3. Comparison of simulation with test results of test condition Nos. 1 to 3 for refrigerant temperature profile.

Fig. 4. Comparison of simulation with test results of test condition Nos. 10 to 12 for refrigerant temperature profile.

Fig. 5. Comparison of simulation with test results of test condition Nos. 19 to 21 for refrigerant temperature profile.

Fig. 6. Comparison of simulation with test results of test condition Nos. 25 to 27 for refrigerant temperature profile.

Fig. 7. Comparison of simulation with test results of all test conditions for refrigerant temperatures at gas cooler outlet.

4. Model applications

The validated model is used to explore the possibility of minimising the approach temperature by means of redesigning the circuits of the gas cooler. As shown in Figure 2, the original gas cooler, named Coil A, has just one circuit for the total 54 pipes. The coil is now rearranged into two circuits named Coil B and three circuits

called Coil C, as shown in Figure 8. In each pipe circuit, there are 27 pipes for Coil B and 18 pipes for Coil C. All other structural parameters in both Coil B and Coil C are kept the same as those in Coil A. Under the same test conditions listed in Table 2, the simulation is run and the approach temperatures and heating loads are predicted and compared for Coil A, Coil

B and Coil C, as shown in Figures 9 , 10 ,11 and 12 respectively.

Fig. 8. Two new circuit arrangements for the tested gas cooler

It is seen from the simulation results that at any test condition, the approach temperature for coil C is slightly less than that of Coil B but much smaller than that of coil A, especially when total refrigerant mass flow rate is lower. The maximum approach temperature decrease by modifying coil A to coil C can reach to 12.1 k at test condition 25. In the mean time, the approach temperature is decreased with increased air front velocity when other parameters are unchanged. In addition, the approach temperature is generally increased with higher ambient air temperature except for some points such as test 1 and test 10 because of the effects of different inlet gas temperatures. The lowest approach temperature predicted in Coil C can bring the highest heating load among these coils at any test condition, as shown in Figures 11 and 12. The maximum heating load increase rate by using coil C to replace coil A can be 52% at test condition 5. Consequently at any test condition Coil A has the lowest heating load compared with the other two coils. At any test condition, Coil C will therefore have the lowest gas outlet enthalpy which will produce highest cooling effect and consequently highest system cooling COP.

Fig. 9. Simulated approach temperatures for Coil A, B and C at various test conditions (1-18).

Fig. 10. Simulated approach temperatures for Coil A, B and C at various test conditions (19-36).

Fig. 11. Simulated heating loads for Coil A, B and C at various test conditions (1-18).

Fig. 12. Simulated heating loads for Coil A, B and C at various test conditions (19-36).

5. Conclusions

A steady state model for finned-tube air-cooled gas coolers has been developed by means of distributed simulation method. Such simulation method is necessary to accurately model a gas cooler since a notable variation of

gas thermophysical parameters and local heat transfer coefficients is expected during the gas cooling process. A proposed model solving strategy when distributed method is used can efficiently run the simulation. The gas cooler model is validated with the experimental results from published

literature at different test conditions. The validated model is utilized to investigate the effect of varied pipe circuit arrangements on the performance of gas coolers and some conclusions are obtained:

- The gas temperature is decreased with the highest rate at the beginning along the pipe from refrigerant inlet to outlet.
- With increased pipe circuits, the gas heat transfer coefficients inside the pipes will be increased and therefore at any test condition, the approach temperature will be decreased and the heating load will be increased. From the simulation results, a maximum 12.1 k approach temperature decrease and 51.5% heating load increase can be achieved when gas cooler pipe circuit numbers are increased. Therefore, in the gas

cooler optimal design, more circuit numbers need be considered.

- The approach temperature is decreased with an increased air front velocity.
- The lower approach temperature can induce higher heating load of the gas cooler and consequently bring higher cooling capacity and system cooling COP.
- An accurate gas cooler model can help in the optimal design of the gas cooler.

References

- [1] E.A. Groll, J.H. Kim, Review of recent advances toward transcritical CO₂ cycle technology, HVAC&R Research, Vol 13, n3, May 2007, 499-520.

- [2] C.E. Bullock, Theoretical performance of carbon dioxide in subcritical and transcritical cycles. ASHRAE/NIST Refrigeration Conference, Refrigerants for 21st Century, 1997, 20-26.
- [3] D.M. Robinson, E.A. Groll, Efficiencies of transcritical CO₂ cycles with and without an expansion turbine, International Journal of Refrigeration 21(7), 1998, 577-589.
- [4] R. Aarli, P.E. Frivik, Comparison of practical performance between CO₂ and R-22 reversible heat pumps for residential use. Proceedings of Natural Working Fluids, IIF-IIR Commission 2, Oslo, Norway, 1998, 388-398.
- [5] S.M. Liao, T.S. Zhao, A. Jakobsen, A correlation of optimal heat rejection pressures in transcritical carbon dioxide cycles, Applied Thermal Engineering 20, 2000, 831-841.
- [6] F. Kauf, Determination of the optimum high pressure for transcritical CO₂-refrigeration cycles, Int. J. Therm. Sci. 38, 1999, 325-330.
- [7] Y. Chen, J. Gu, The optimum high pressure for CO₂ transcritical refrigeration systems with internal heat exchangers, International Journal of Refrigeration 28, 2005, 1238-1249.
- [8] X. Fang, C. Bullard, P. Hrnjak, Heat transfer and pressure drop of gas coolers, ASHRAE Trans ,107(1), 2001, 255-266.
- [9] J.M. Yin, C.W. Bullard, P.S. Hrnjak, R-744 gas cooler model development and validation, International Journal of Refrigeration, 24, 2001, 692-701.
- [10] T.M. Ortiz, D. Li, E.A. Groll, Evaluation of the performance

- potential of CO₂ as a refrigerant in air-to-air air conditioners and heat pumps: system modeling and analysis, Final report, ARTI-21CR/610-10030, December 2003.
- [11] J. Pettersen, A. Hafner, G. Skaugen, H. Rekstad. Development of compact heat exchangers for CO₂ air-conditioning systems, *International Journal of Refrigeration*, 21(3), 1998, 180-193.
- [12] M.H. Kim, J. Pettersen, C.W. Bullard. Fundamental process and system design issues in CO₂ vapour compression systems. *Progress in Energy and Combustion Science*, 30, 2004, 119-174.
- [13] P.A. Domanski, EVSIM-An evaporator simulation model accounting for refrigerant and one-dimensional air, NISTIR-89-4133. Washington, DC:NIST,1989.
- [14] P.A. Domanski, D. Yashar, Optimization of finned-tube condensers using an intelligent system, *International Journal of Refrigeration* 30(2007) 482-488.
- [15] Y.S. Chang, M.S. Kim. Modelling and performance simulation of a gas cooler for CO₂ heat pump system. V13,n3, *HVAC&R Research*, May 2007, 445-456.
- [16] A. Bensafi, S. Borg and D. Parent, CYRANO: a computational model for the detailed design of plate-fin-and-tube heat exchangers using pure and mixed refrigerants, *Int. J. Refrigeration*. Vol. 20 (1997), No.3, 218-228.
- [17] V. Casson, A. Cavallini, L. Cecchinato, D. Del Col, L. Doretti, E. Fornasieri, L. Rossetto, C. Zilio, Performance of finned coil condensers optimized for new HFC refrigerants, *ASHRAE*

- Transactions, (2002) 108 (2), 517-527.
- [18] C. Zilio, L. Cecchinato, M. Corradi, G. Schiochet, An assessment of heat transfer through fins in a fin-and-tube gas cooler for transcritical carbon dioxide cycles. Vol. 30, 2007, No. 3, HVAC&R Research.
- [19] H. Jiang, V. Aute, R. Radermacher, CoilDesigner: a general-purpose simulation and design tool for air-to-refrigerant heat exchangers, International Journal of Refrigeration 29, 2006, 601-610.
- [20] J. Sarkar, S. Bhattacharyya, m. R. Gopal. Simulation of a transcritical CO₂ heat pump cycle for simultaneous cooling and heating applications. International Journal of Refrigeration 29, 2006, 735-743.
- [21] M. McLinden, S.A. Klein, E.W. Lemmon, A.P. Peskin. NIST thermodynamic and transport properties of refrigerants and refrigerant mixtures- REFPROP, v6.0, NIST Standard Reference database 23,1998.
- [22] S.S. Pitla, E.A. Groll, S. Ramadhyani. New correlation to predict the heat transfer coefficient during in-tube cooling of turbulent supercritical CO₂. International Journal of Refrigeration 25, 2002, 887-895
- [23] F.P. Incropera, D.P. DeWitt. Introduction to heat transfer. 3rd ed. New York: John Wiley & Sons, 1996.
- [24] C.C. Wang, J.Y. Jang, N.F. Chiou, 1999a, A heat transfer and friction correlation for wavy fin-and-tube heat exchangers, Int. J. of Heat Mass Transfer 42, 1919-1924.
- [25] C.C. Wang, W.S. Lee, W.J. Sheu, 2001, A comparative study of compact enhanced fin-and-tube

heat exchangers, Int. J. of Heat
Mass Transfer 44, 3565-3573.

- [26] Y.Hwang, D.H Jin, R. adermacher,
J.W. Hutchins. Performance
measurement of CO₂ heat
exchangers, ASHRAE Trans.
2005, 306-316.

ACCEPTED MANUSCRIPT

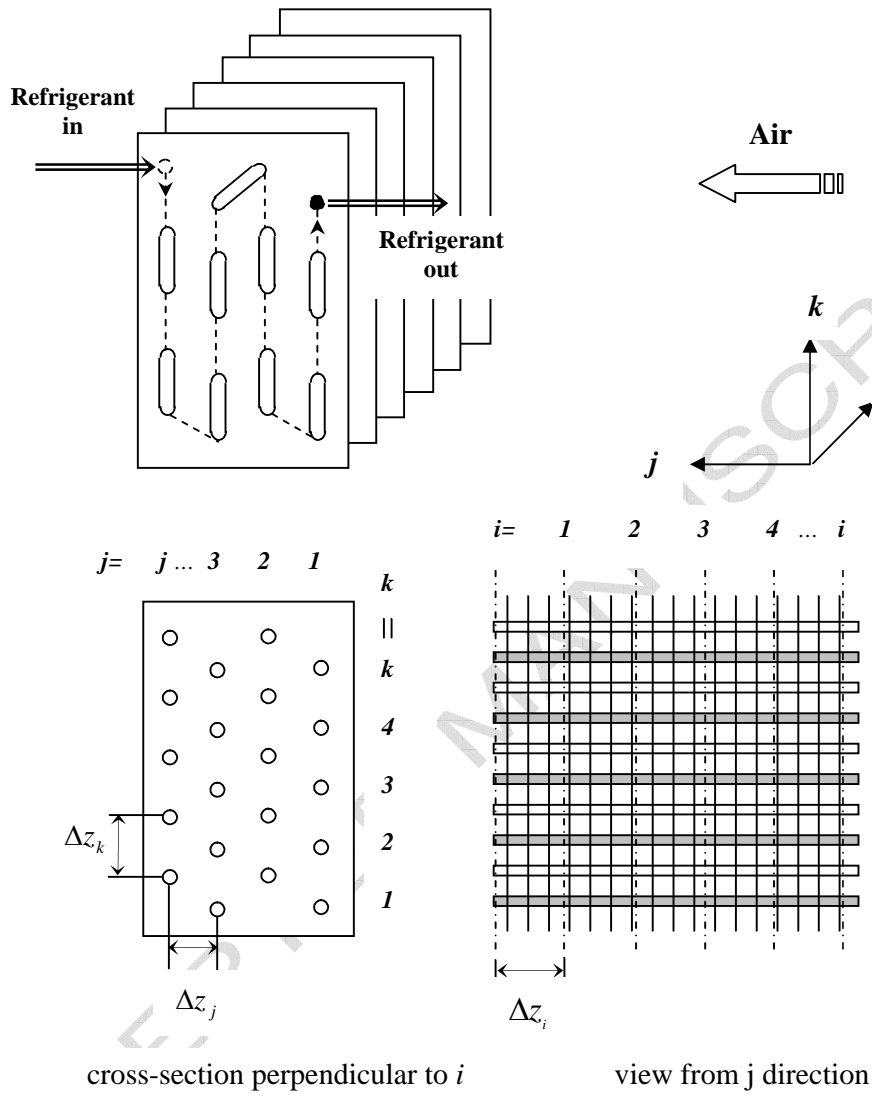

Fig. 1. Three-dimensional coordinate of sub elements in the coil for the gas cooler model

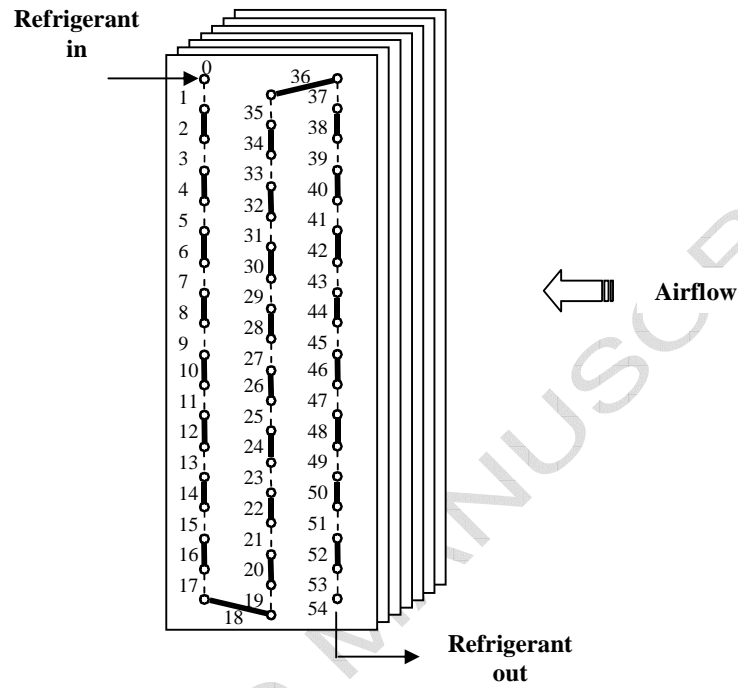

Fig. 2. Tested gas cooler (Coil A) with numbered pipes

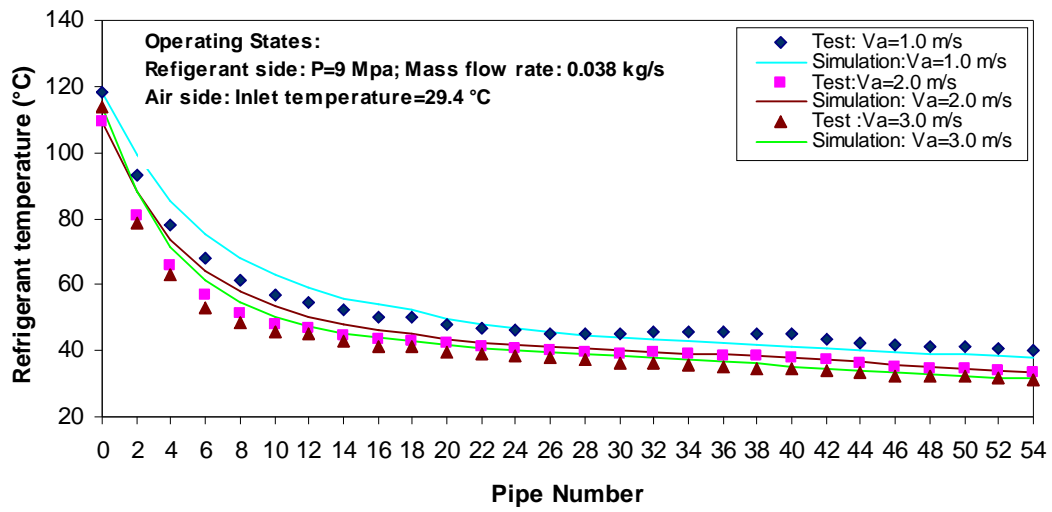

Fig. 3. Comparison of simulation with test results of test condition Nos. 1 to 3 for refrigerant temperature profile.

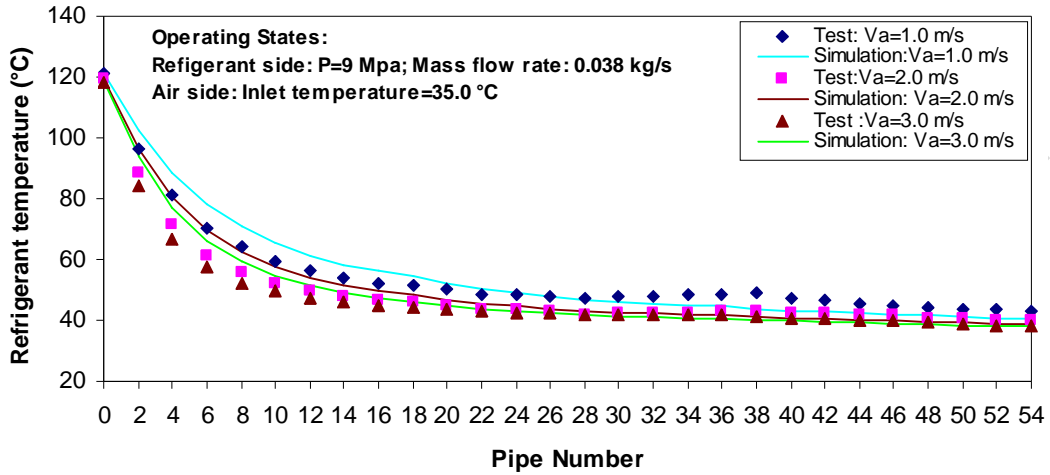

Fig. 4. Comparison of simulation with test results of test condition Nos. 10 to 12 for refrigerant temperature profile.

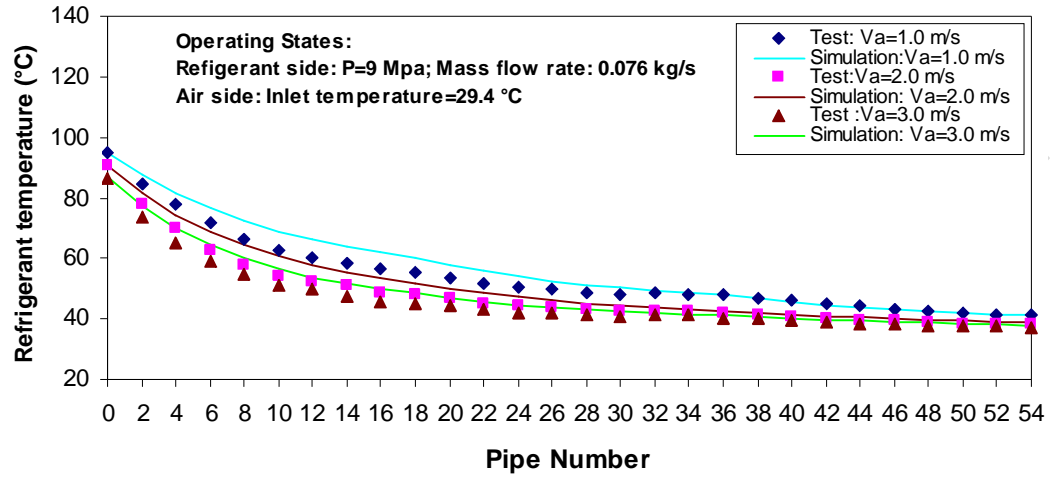

Fig. 5. Comparison of simulation with test results of test condition Nos. 19 to 21 for refrigerant temperature profile.

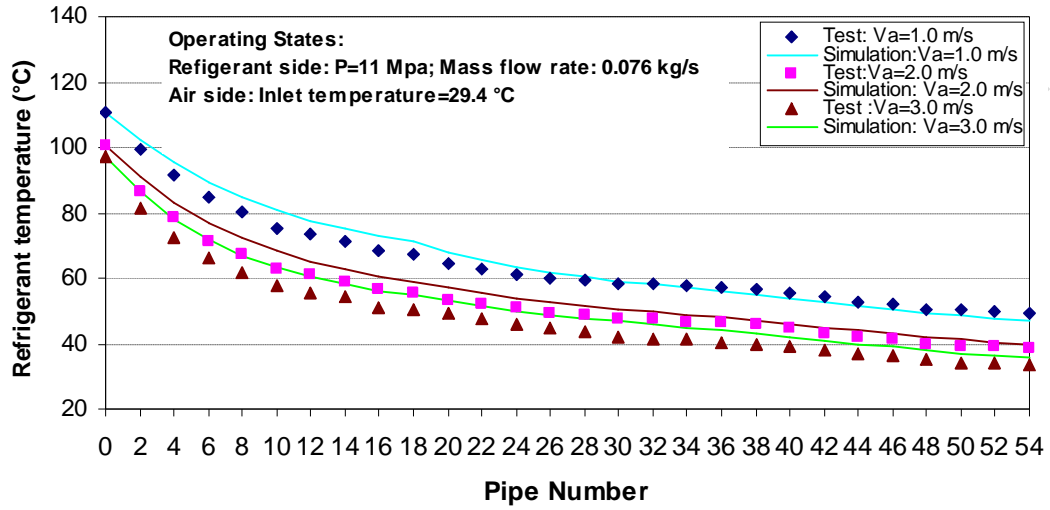

Fig. 6. Comparison of simulation with test results of test condition Nos. 25 to 27 for refrigerant temperature profile.

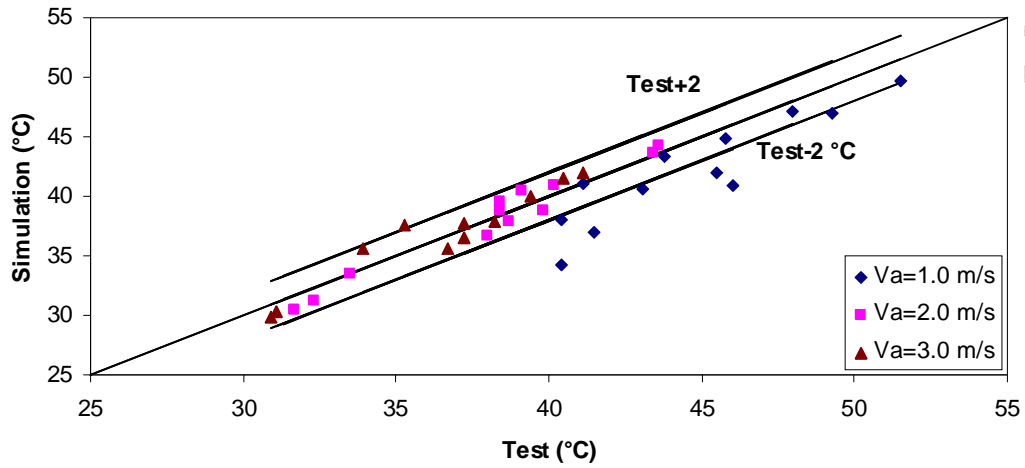

Fig. 7. Comparison of simulation with test results of all test conditions for refrigerant temperatures at gas cooler outlet.

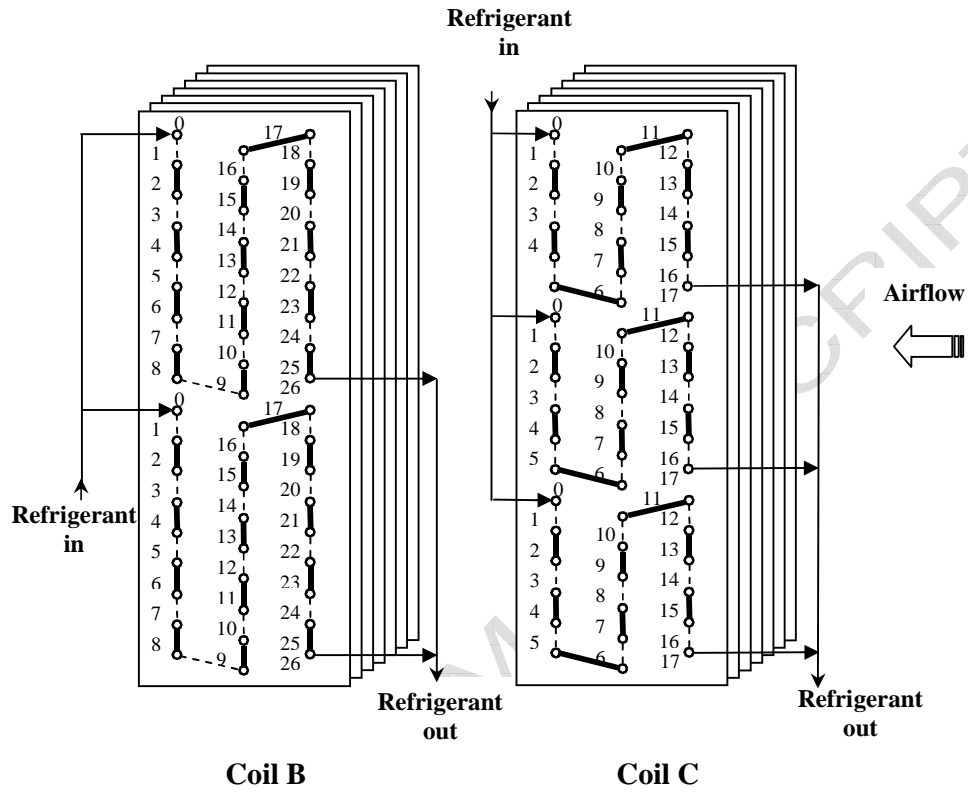

Fig. 8. Two new circuit arrangements for the tested gas cooler

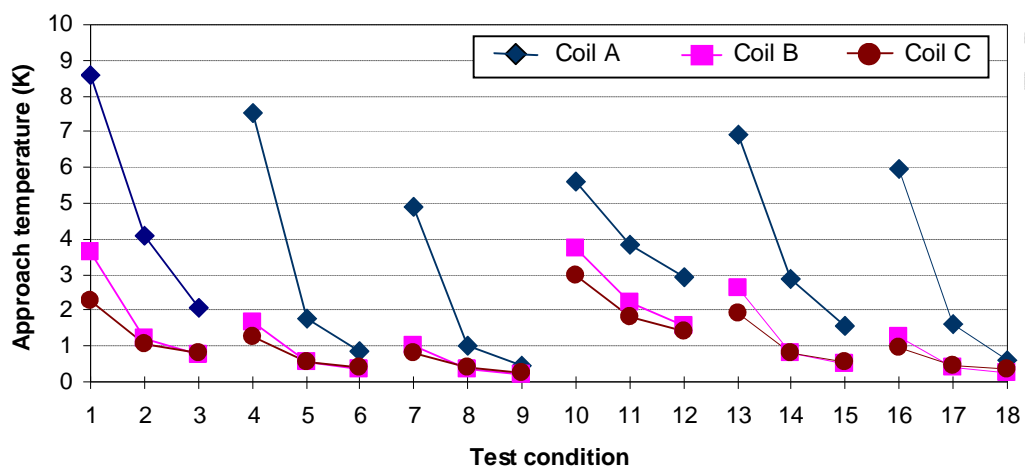

Fig. 9. Simulated approach temperatures for Coil A, B and C at various test conditions

(1-18).

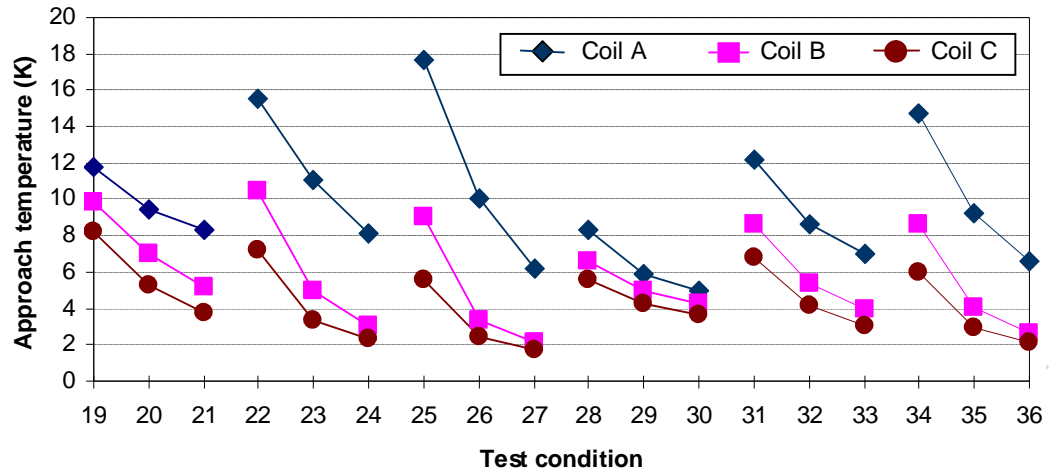

Fig. 10. Simulated approach temperatures for Coil A, B and C at various test conditions (19-36).

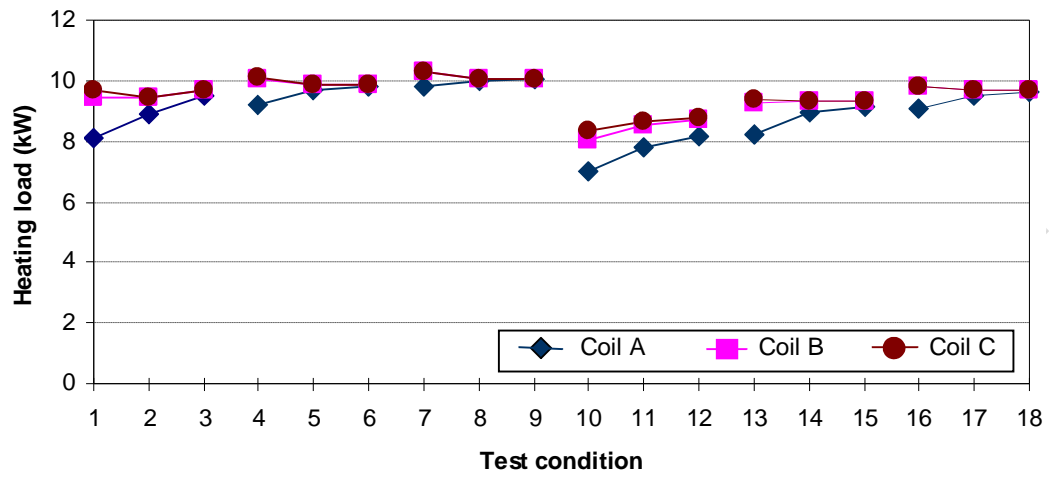

Fig. 11. Simulated heating loads for Coil A, B and C at various test conditions

(1-18).

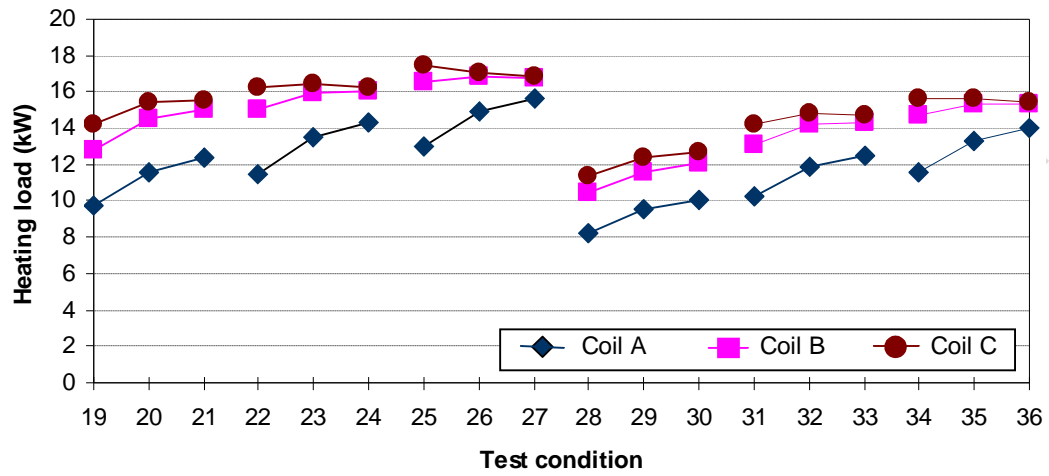

Fig. 12. Simulated heating loads for Coil A, B and C at various test conditions

(19-36).

Table 1 Specification of the tested gas cooler

Dimension	W×H×D [m]	0.61×0.46×0.05
	Front area [m ²]	0.281
Fin	Shape	Raised lance
	Fin pitch [mm]	1.5
	Thickness [mm]	0.13
Tube	No. of tubes row	3
	No. of tubes per row	18
	Tube outside diameter [mm]	7.9
	Tube inside diameter [mm]	7.5
	Tube shape	smooth

Table 2 Test conditions (including tested and simulated refrigerant outlet temperatures)

Test cond.	Air inlet air temp. [°C]	Air velocity [m/s]	Refri. inlet temp. [°C]	Refri. inlet pressure [MPa]	Refri. flow rate [kg/s]	Tested Refri. Outlet temp. [°C]	Simu. Refri. Outlet temp. [°C]
1	29.4	1	118.1	9	0.038	40.4	38.0
2	29.4	2	109.5	9	0.038	33.5	33.5
3	29.4	3	113.5	9	0.038	31.3	31.5
4	29.4	1	124	10	0.038	41.5	36.9
5	29.4	2	118	10	0.038	32.3	31.2
6	29.4	3	117.1	10	0.038	31.1	30.3
7	29.4	1	128.8	11	0.038	40.4	34.3
8	29.4	2	123.5	11	0.038	31.7	30.4
9	29.4	3	123.1	11	0.038	30.9	29.9
10	35	1	121.3	9	0.038	43.1	40.6
11	35	2	119.4	9	0.038	39.8	38.8
12	35	3	118.8	9	0.038	38.2	37.9
13	35	1	127.7	10	0.038	45.5	41.9
14	35	2	122.6	10	0.038	38.7	37.9
15	35	3	122.2	10	0.038	37.2	36.6
16	35	1	133.3	11	0.038	46.0	40.9
17	35	2	128.9	11	0.038	38.0	36.6
18	35	3	128.4	11	0.038	36.7	35.6

19	29.4	1	94.8	9	0.076	41.1	41.1
20	29.4	2	90.8	9	0.076	38.4	38.8
21	29.4	3	86.9	9	0.076	37.2	37.8
22	29.4	1	103.3	10	0.076	45.8	44.9
23	29.4	2	94.8	10	0.076	39.1	40.4
24	29.4	3	90.7	10	0.076	35.3	37.5
25	29.4	1	110.6	11	0.076	49.3	47.0
26	29.4	2	100.7	11	0.076	38.4	39.5
27	29.4	3	97.1	11	0.076	33.9	35.6
28	35	1	92.5	9	0.076	43.8	43.3
29	35	2	90	9	0.076	40.2	40.9
30	35	3	88.4	9	0.076	39.4	40.0
31	35	1	104.1	10	0.076	48.0	47.2
32	35	2	98.4	10	0.076	43.4	43.6
33	35	3	93.9	10	0.076	41.1	42.0
34	35	1	109.6	11	0.076	51.5	49.7
35	35	2	101.9	11	0.076	43.6	44.3
36	35	3	98.4	11	0.076	40.5	41.6