



HAL
open science

Wind turbines condition monitoring and fault diagnosis using generator current amplitude demodulation.

Yassine Amirat, Vincent V. Choqueuse, Mohamed Benbouzid

► **To cite this version:**

Yassine Amirat, Vincent V. Choqueuse, Mohamed Benbouzid. Wind turbines condition monitoring and fault diagnosis using generator current amplitude demodulation.. IEEE International Energy Conference and Exhibition (EnergyCon), 2010, Dec 2010, Manama, Bahrain. pp.310 -315, 10.1109/ECCE.2010.5617914 . hal-00594531

HAL Id: hal-00594531

<https://hal.science/hal-00594531>

Submitted on 20 May 2011

HAL is a multi-disciplinary open access archive for the deposit and dissemination of scientific research documents, whether they are published or not. The documents may come from teaching and research institutions in France or abroad, or from public or private research centers.

L'archive ouverte pluridisciplinaire **HAL**, est destinée au dépôt et à la diffusion de documents scientifiques de niveau recherche, publiés ou non, émanant des établissements d'enseignement et de recherche français ou étrangers, des laboratoires publics ou privés.

Wind Turbines Condition Monitoring and Fault Diagnosis Using Generator Current Amplitude Demodulation

Y. Amirat, V. Choqueuse and M.E.H Benbouzid

University of Brest, EA 4325 LBMS

Rue de Kergoat, CS 93837, 29238 Brest Cedex 03, France

Yassine.Amirat@univ-brest.fr, Vincent.Choqueuse@univ-brest.fr and Mohamed.Benbouzid@univ-brest.fr

Abstract—Wind energy conversion systems have become a focal point in the research of renewable energy sources. In order to make wind turbines as competitive as the classical electric power stations, it is important to reduce the operational and maintenance costs. The most efficient way of reducing these costs would be to continuously monitor the condition of these systems. This allows for early detection of the degradation of the generator health, facilitating a proactive response, minimizing downtime, and maximizing productivity. This paper provides then an approach based on the generator stator current data collection and attempts to highlight the use of Hilbert transformation for failure detection in a Doubly-Fed Induction Generator (DFIG) based wind turbine for stationary and nonstationary cases.

Index Terms—Wind turbine, DFIG, fault detection, diagnosis, amplitude modulation, Hilbert transform.

I. INTRODUCTION

Wind energy conversion systems are the fastest-growing source of new electric generation in the world and it is expected to remain so for some time. Classical power generation systems, which are facing to constantly changing operating parameters, such as fuel cost, multiple fuel tradeoffs and maintaining older system, becomes more costly and challenging with obsolescence of key components. DFIG-based wind turbines offer an alternative and emerging solution but due to geographical location of wind turbines particularly in the off-shore wind farms, it is important to prevent failure and to reduce maintenance cost. A deep knowledge about all the phenomena involved during the occurrence of a failure constitutes an essential background for the development of any failure diagnosis system. Regarding a failure as a particular input acting on the generator, a diagnosis system must be able to detect its occurrence, as well as to isolate it from all other inputs such as disturbances and controls affecting the behavior of the DFIG.

For the failure detection problem, it is important to know if a failure exists or not in the generator via the processing of available measurements. For the failure diagnosis problem, in addition, to identify the element of the system which has failed and to find the failure causes. A quantitative analysis of

real wind turbine failure data has shown important features of failure rate values and trends [1]. A failures number distribution check-off is reported in Figs. 1 and 2 for Swedish, Danish and German wind power plants that occurred between 1994 and 2004 [1].

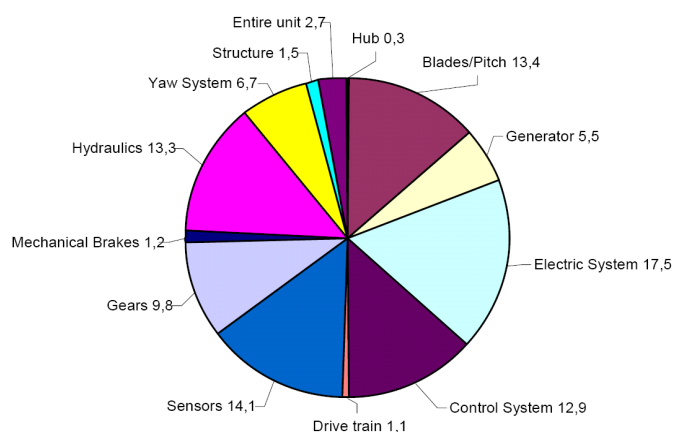

Fig. 1. Failures number distribution for Swedish wind power plants (2000-2004) [1].

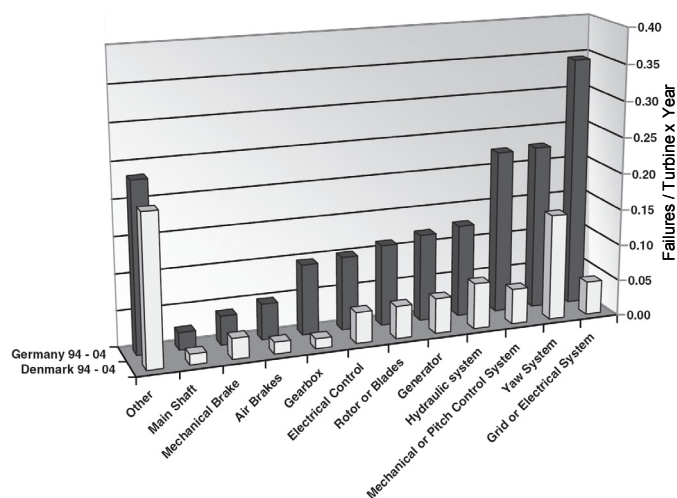

Fig. 2. Failure rates for Danish and German wind power plants [1].

These figures show that approximately 45 % of failures were linked to the electrical system, sensors and blades/pitch components. The experience feedback of wind turbine industries states that the major concern is on the electrical system. Typical failures include: dynamic air gap irregularities, generator bearing failure, stator and rotor winding; insulation failures, inter-turn short circuits in stator windings, broken rotor bar or cracked rotor end-rings and harmonic derating.

Many techniques and tools are available for the condition monitoring of DFIG-based wind turbines in order to extend their life span. Some of the technology used for monitoring includes pre-installed sensors, which may measure speed, output torque, vibrations, temperature, flux densities, etc. These sensors are managed together in different architectures and coupled with algorithms to allow an efficient monitoring of the system condition. Those methods are inspired from electric motor condition monitoring. From the theoretical and experimental point of view, the well-established methods are: electrical quantities signature analysis (current, power...), vibration monitoring, temperature monitoring and oil monitoring. In the case of DFIG-based wind turbines, it has been shown that failure in the drive train could be diagnosed from the electrical quantities of the generator [2]. This principle has been used to diagnose unbalance and failure in the blades of a small wind turbine by measuring the power spectrum density at the turbine generator terminal [3]. The advantage of signature analysis of the generator electrical quantities is that those quantities are easily extractible during operation i.e. the current can be acquired by current transformer, the voltage via a voltage transformer and the power by computation. Moreover, current and voltage transducers are usually cheaper than vibration and torque transducers. Analysis of the generator electrical quantities usually involves the use of signal processing techniques.

For steady state operations, the Fast Fourier Transform (FFT) is the most popular algorithm; however it has a lack to unfulfill the nonstationary quantities. In the case of variable speed DFIG-based wind turbines, FFT is difficult to interpret since the operation is predominately nonstationary due the stochastic behavior of the wind speed. To overcome this problem, electric machine conditions monitoring and failure diagnosis procedures based on time-frequency representations (Spectrogram, Quadratic TFR, etc...) or time-scale analysis (wavelet) have been proposed in the literature of the electric machines community [4-6]. Nevertheless, these techniques have drawbacks such as high complexity, poor resolution and/or may suffer from artifacts (cross-terms, etc.).

This paper presents then a less complex failure detector for DFIG-based wind turbines which is appropriate for nonstationary operations and transient behavior. It focuses on mechanical failures that lead to stator current Amplitude Modulation (AM). These include, for example, air gap eccentricity, bearing wear and failure [7]. It is organized as follows. Section II describes the signal processing technique used for failure detection. Section III presents the adopted

approach for data collection for real wind turbine. Section IV describes the data lab facility used to validate the proposed approach. Finally, the performance of the method is reported in section V.

II. SIGNAL PROCESSING TECHNIQUE

For amplitude modulated signals, the received current $i(n)$ can be expressed as

$$i(n) = a(n) \cos(2\pi n f / F_e + \phi) \quad (1)$$

where $n = 0, \dots, N-1$ is the sample index, N is the number of received samples, ϕ is the phase parameter and F_e is the sampling frequency. The amplitude $a(n)$ in (1) depends on the failure hypothesis: for a healthy generator, $a(n)$ is constant, and for faulty generator, it varies with time (Amplitude Modulation).

For failure detection, a possible approach relies on the use of an amplitude demodulation technique to estimate $a(n)$. Then, statistical features can be extracted to detect if it is time-varying or not.

A. Amplitude Demodulation

Popular amplitude demodulation techniques include Hilbert Transform (HT) [8] and Teager energy operator [9]. Furthermore for three-phase system, it has been recently shown that the Concordia transform can be employed to perform demodulation [10]. In this study, one phase current is considered. In this context, the Hilbert transform is chosen to estimate the envelope $a(n)$ since it is usually more robust against noise than the Teager energy operator.

Let us consider a discrete sequence $i(n)$. The Discrete Hilbert Transform (DHT) of $i(n)$ is given by [8].

$$\mathcal{H}[i(n)] = \mathcal{F}^{-1} \{ \mathcal{F} \{ i(n) \} \cdot u(n) \} \quad (2)$$

where $\mathcal{F}\{\cdot\}$ and $\mathcal{F}^{-1}\{\cdot\}$ correspond to the Fast Fourier Transform (FFT) and Inverse FFT (IFFT), respectively, and where $u(n)$ is defined as

$$u(n) = \begin{cases} 1, & n = 0, \frac{N}{2} \\ 2, & n = 1, 2, \dots, \frac{N}{2} - 1 \\ 0, & n = \frac{N}{2} - 1, \dots, N - 1 \end{cases} \quad (3)$$

Using (1), the estimated envelope, denoted $\hat{a}(n)$, is given by [8].

$$\hat{a}(n) = \sqrt{i^2(n) + (\mathcal{H}[i_k(n)])^2} \quad (4)$$

B. Failure detector

After applying Hilbert transform, we propose to determine if $\hat{a}(n)$ is time-varying or not. Let us compute the variance of $\hat{a}(n)$, denoted σ^2 , which is defined by

$$\sigma^2 = \frac{1}{N} \sum_{n=0}^{N-1} (\hat{a}(n) - \mu)^2 \quad (5)$$

where μ is $\hat{a}(n)$ mean, i.e.

$$\mu = \frac{1}{N} \sum_{n=0}^{N-1} \hat{a}(n) \quad (6)$$

As $\hat{a}(n)$ is constant for healthy generator, it follows that $\mu = \hat{a}(n)$ and then $\sigma^2 = 0$. For faulty generator, the envelope $\hat{a}(n)$ is time-varying which implies that $\mu \neq \hat{a}(n)$ and then $\sigma^2 > 0$. These two properties lead us to propose a simple hypothesis test for failure detection based on σ^2 :

- If $\sigma^2 < \gamma$, the generator is stated healthy.
- If $\sigma^2 > \gamma$, the generator is stated faulty.

Where γ is a threshold which can be set subjectively depending on a false alarm probability.

III. DATA COLLECTION FOR REAL WIND TURBINE

Today, most turbines are fitted with equipment that makes it possible to collect condition monitoring data remotely via modem or internet. Moreover, since wind turbines are

typically built in onshore or offshore wind farm configurations; there is a need for building up networks. The proposed architecture is based on an industrial PC (EPC) which is dedicated to collect data from the DFIG-based wind turbines via the extended I/O modules and transfers the data to users through LAN network. The EPC is configured to transmit data in asynchronous mode such that all the data are stored (buffered) in specific data blocs and no data are lost during the processing. This allows investigation of data for further purposes. The EPC has also the task for managing alarm and emergency shut down procedure. Figure 3 depicts the data collection approach for a real wind turbine via an industrial data bus. The data flow scheme is shown by Fig. 4.

This architecture incorporates a SCADA system and a CMS system, where the SCADA system is devoted to supervise and control the DFIG-based wind turbines through the EPC. For laboratory experiments the wind turbine is often replaced by a DC or an AC motor that acts as a prime mover.

IV. TEST FACILITY DESCRIPTION

Figure 5 describes the experimental setup that is operated in the motor configuration for experimental easiness. It is composed of two parts: a mechanical part that has a tachogenerator, a three-phase induction motor and an alternator. The tachogenerator is a DC machine that generates 90 V at 3000 rpm. It is used to measure the speed. It produces linear voltage between 2500 and 3000 rpm.

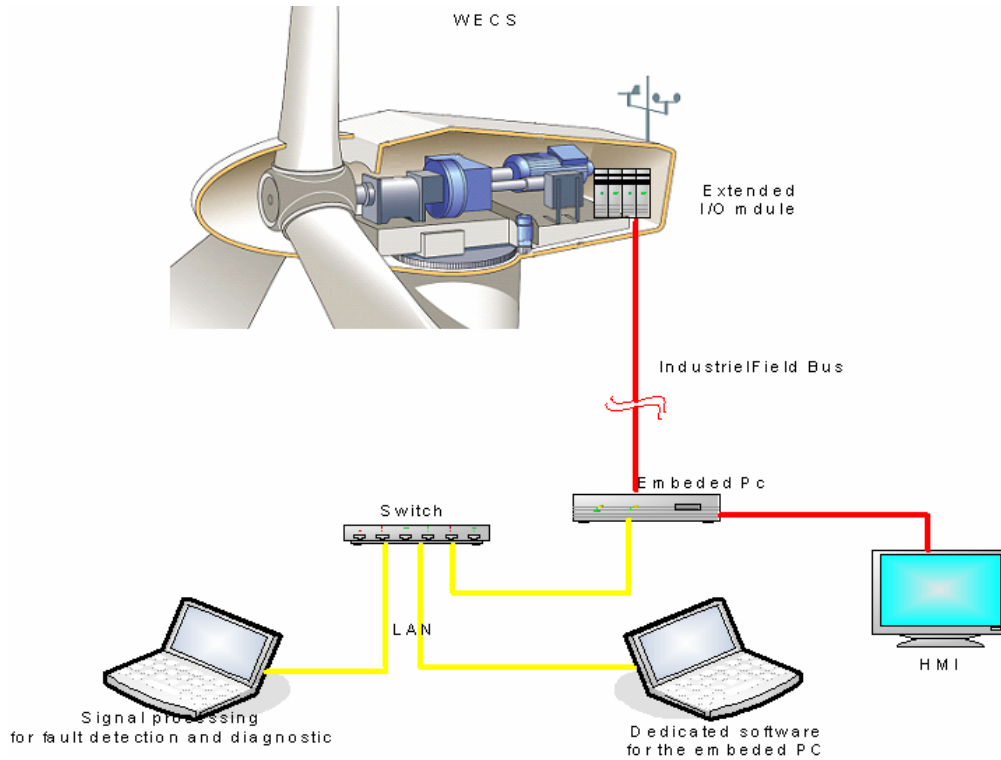

Fig. 3. Test rig configuration.

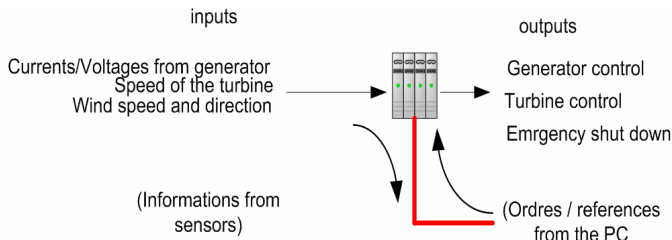

Fig. 4. Data flow between DFIG-based wind turbines and embedded PC.

The alternator is a three-phase synchronous machine with a regulator and a rectifier circuit that stabilize the output voltage at 12 VDC. The advantage of using a car alternator instead of DC generator is obtaining constant output voltage at various speeds. The induction motor could be identically loaded at different speeds. Moreover, if the induction motor is supplied from the network, motor current will have time and space harmonic components as well as bearing fault sourced harmonics. This makes it harder to determine the bearing failure effect on the stator current and therefore complicates

the fault detection process. For these reasons, the induction is fed by an alternator. By this way, supply harmonics effects are eliminated and only bearing failure effects could be observed on the stator current. Figure 6 is then given to illustrate the experimental test philosophy.

The tested induction motor has the following rated parameters: 0.75 kW, 220/380 V, 1.95/3.4 A, 2780 rpm, 50 Hz, 2 poles, Y-connected. It has two 6204.2ZR type bearings. From the bearing data sheet the following parameters are obtained: The outside diameter is 47 mm and inside one is 20 mm. Assuming that the inner and the outer races have the same thickness gives the pitch diameter $D_p = 31.85$ mm. The bearing has eight balls ($N = 8$) with an approximate diameter of $D_B = 12$ mm and a contact angle $\theta = 0^\circ$. These bearings are made to fail by drilling holes of various radiuses with a diamond twist bit while controlling temperature by oil circulation in experiments. Some of the artificially deteriorated bearings are shown in Figure 7.

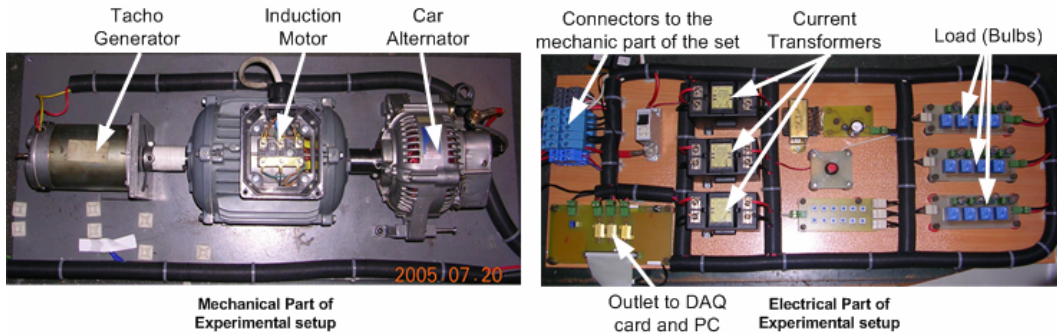

Fig. 5. Experimental setup [11].

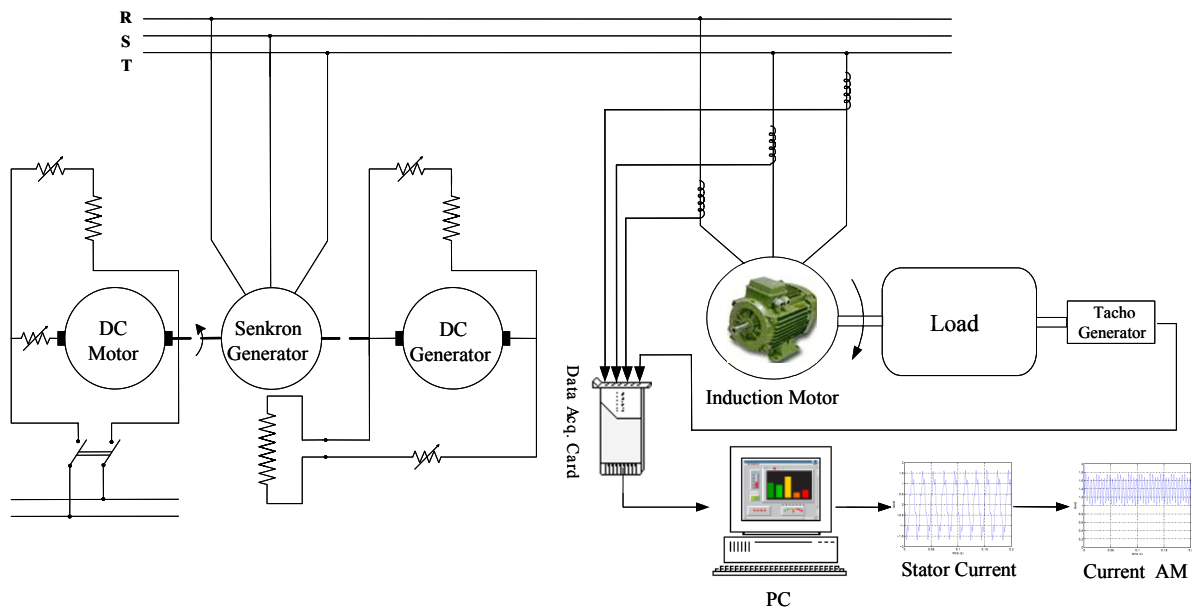

Fig. 6. Test facility [11].

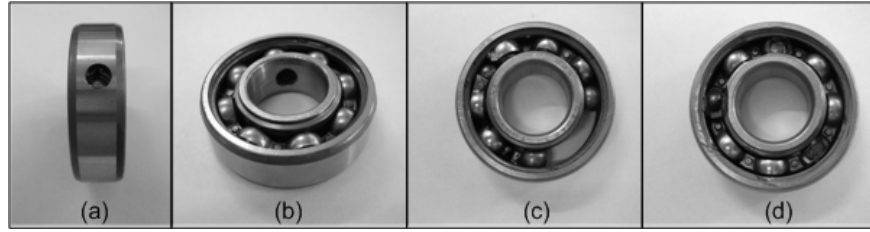

Fig. 7. Artificially deteriorated bearings: (a) outer race deterioration, (b) inner race deterioration, (c) cage deterioration, (d) ball deterioration [11].

V. FAILURE DETECTOR TEST

In this section, the result of the proposed approach is presented with experimental signals corresponding to fault (a) (Fig. 7).

After Hilbert transform, 10 samples have been removed at the beginning and at the end of $\hat{a}(n)$ to avoid the edge effects problem of Hilbert transform. Figures 8 and 9 display the stator current $i(n)$ and the envelope $\hat{a}(n)$, respectively, for a healthy generator. As the system is not perfect, one could note small variations on the envelope $\hat{a}(n)$. In the presence of a bearing failure, the stator current and the envelope are shown in Figs. 10 and 11, respectively. Compared to the healthy case, stronger oscillations of $\hat{a}(n)$ can be observed.

Table I reports the value of σ^2 for the faulty and healthy generators. As previously discussed, σ^2 is not strictly equal to 0 even if the generator is healthy ($\sigma^2 = 0.012$). However when a bearing failure occurs, this criteria is multiply by 4.333. In this condition, a failure can be detected by setting the hypothesis-test threshold to $\sigma^2 = 0.032$.

VI. CONCLUSION

This paper has presented an implementation of a low-complexity signal processing technique for bearing faults detection in DFIG-based wind turbines. It was found that the proposed technique gives a significant criterion for failure detection.

Table 1. Non-balanced system:
Fault detector for healthy and faulty generator.

Demodulation	Healthy case	Faulty case
Hilbert Transform	$\sigma^2 = 0.012$	$\sigma^2 = 0.052$

REFERENCES

- [1] Y. Amirat, M. Benbouzid and E. Al-Ahmar, "A brief status on condition monitoring and fault diagnosis in wind energy conversion systems," *Renewable & Sustainable Energy Reviews*, vol. 3, n°9, pp. 2629-2636, December 2009.
- [2] E. Al-Ahmar, M.E.H. Benbouzid and Y. Amirat, "DFIG-based wind turbine fault diagnosis using a specific discrete wavelet transform," in *Proceedings of ICEM'08 (International Conference on Electrical Machines)*, Vilamoura (Portugal), September 2008.
- [3] W.Q. Jeffries, J.A. Chambers, and D.G. Infield, "Experience with bicoherence of electrical power for condition monitoring of wind turbine blades," *IEE Proc Vision, Image & Signal Processing*, vol. 145, n°3, pp. 141-148, June 1998.
- [4] S. Rajagopalan, J. A. Restrepo, J. Aller, T. Habetler, and R. Harley, "Non stationary motor fault detection using recent quadratic time frequency representations," *IEEE Trans. Industry Applications*, vol. 44, n°3, pp. 735-744, May/June 2008.

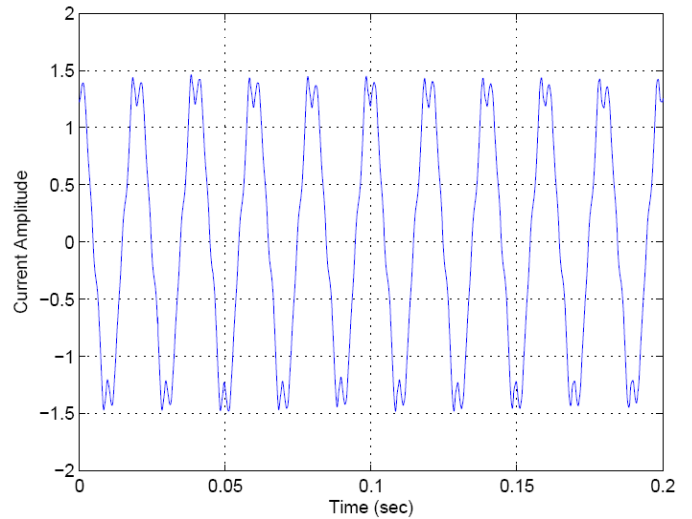

Fig. 8. Stator current $i(n)$ of a healthy generator.

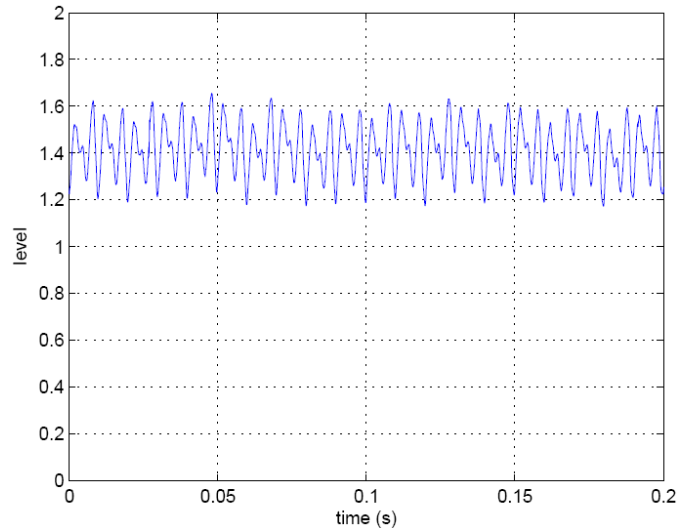

Fig. 9. Envelope $\hat{a}(n)$ of a healthy generator.

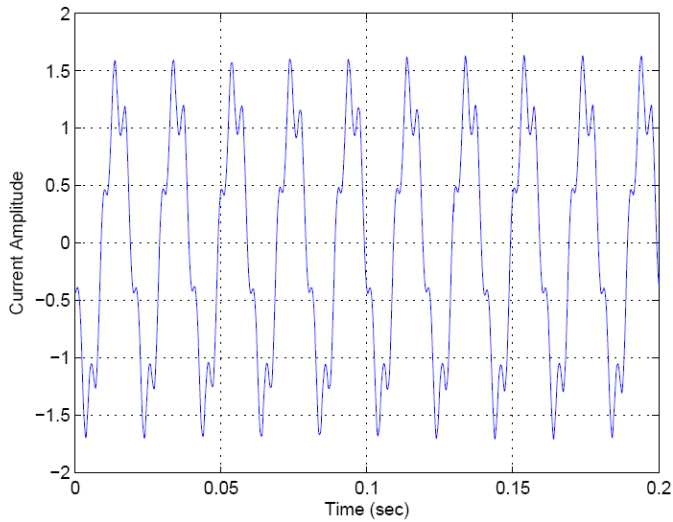

Fig. 10. Stator current $i(n)$ of a faulty generator.

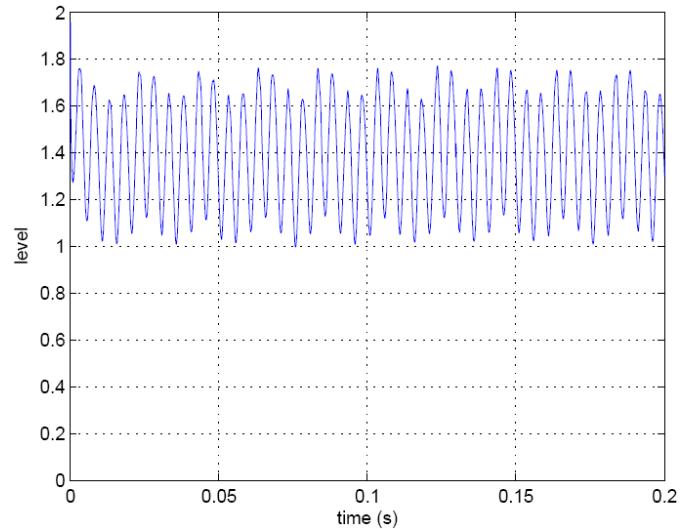

Fig. 11. Envelope $\hat{a}(n)$ of a faulty generator.

- [5] M. Blodt, D. Bonacci, J. Regnier, M. Chabert, and J. Faucher, "Online monitoring of mechanical faults in variable-speed induction motor drives using the Wigner distribution," *IEEE Trans. Industrial Electronics*, vol. 55, n°2, pp., 522-533, February 2008.
- [6] M. Riera-Guasp, J. Antonio-Daviu, J. Roger-Folch, and M. P. M. Palomares, "The use of the wavelet approximation signal as a tool for the diagnosis of rotor bar failure," *IEEE Trans. Industry Applications*, vol. 44, n°3, pp. 716-726, May/June 2008.
- [7] M. Blodt, J. Regnier, and J. Faucher, "Distinguishing load torque oscillations and eccentricity faults in induction motors using stator current Wigner distributions," *IEEE Trans. Industry Applications*, vol. 45, n°6, pp. 1991-2000, November/December 2009.
- [8] A. Oppenheim, R. Schaffer and W. Padgett. *Discrete-Time Signal Processing*, 3rd Ed. Prentice Hall, 2009.
- [9] P. Maragos, J. Kaiser, and T. Quatieri, "On amplitude and frequency demodulation using energy operators," *IEEE Trans. Signal Processing*, vol. 41, n°4, pp. 1532-1550, April 1993.
- [10] B. Trajin, M. Chabert, J. Regnier, and J. Faucher, "Hilbert versus Concordia transform for three phase machine stator current time-frequency monitoring," *Mechanical Systems & Signal Processing*, vol. 23, pp. 2648-2657, 2009.
- [11] I. Önel and M. Benbouzid, "Induction motor bearing failure detection and diagnosis: Park and Concordia transform approaches comparative study," *IEEE/ASME Trans. Mechatronics*, vol. 13, n°2, pp. 257-262, April 2008.