



HAL
open science

Conception of a simulator for a TEL system in orthopaedic surgery.

Aurélie Larcher, Vanda Luengo, J. Tonetti

► **To cite this version:**

Aurélie Larcher, Vanda Luengo, J. Tonetti. Conception of a simulator for a TEL system in orthopaedic surgery.. Virtual Reality International Conference (VRIC 2010), 2010, France. pp.1-8. hal-00593054

HAL Id: hal-00593054

<https://hal.science/hal-00593054>

Submitted on 13 May 2011

HAL is a multi-disciplinary open access archive for the deposit and dissemination of scientific research documents, whether they are published or not. The documents may come from teaching and research institutions in France or abroad, or from public or private research centers.

L'archive ouverte pluridisciplinaire **HAL**, est destinée au dépôt et à la diffusion de documents scientifiques de niveau recherche, publiés ou non, émanant des établissements d'enseignement et de recherche français ou étrangers, des laboratoires publics ou privés.

Conception of a simulator for a TEL system in orthopedic surgery

LARCHER, Aurelie¹, LUENGO, Vanda¹, TONETTI, Jérôme²

¹Laboratoire Informatique de Grenoble (L.I.G.) Université Joseph Fourier, Grenoble, France

²CHU de Grenoble, Service d' Orthopédie-Traumatologie, Grenoble, France
Nom.prenom@imag.fr

Abstract—Within a research project whose aim is to promote the learning of percutaneous operation in orthopedic surgery, we investigate some representation models of empirical, deductive, and perceptivo-gestural knowledge. From these models, we design an TEL system (Technological Enhanced Learning) This project belongs to a multidisciplinary field including computer, orthopedic surgery, medical imaging, didactic and cognitive sciences. The article presents the design principles of TEL with a particular interest in the development of a simulator. This simulator allows a virtual exercise interacting with the learner in visual, temporal and haptic dimension.

TEL, Modeling, Simulation, Haptic, 3D, orthopaedic surgery

I. INTRODUCTION

A critical issue in the design of TEL for medical training is the relationship between technology and training effectiveness [7]. For us the main challenge is to propose computer tools, based on educational and cognitive science theories, to re-think the TEL system in order to achieve adequate apprenticeship realism and to organize the feedback.

The TELEOS Project (*Technology Enhanced Learning Environment for Orthopaedic Surgery*) supported by the ANR¹ is principally aiming to promote the learning of percutaneous orthopaedic surgery.

For the design of our TEL environments in medical education, we use some computer representations. For choose these computer representations we take into account knowledge and learning characteristics.

Indeed, in our case there are three types of knowledge that are at stake during this learning activity: declarative, perceptivo-gestural and empirical. Besides, in our case, the learning situations are the problem solving situations. The fidelity of problems in this approach is not a material fidelity but is posed in terms of an epistemic fidelity. It thus requires to transform the working situations into training-oriented situations. The main important criteria that are considered to build these problems are the relevant variables for learning, also called “didactical variables” and the “milieu” [2] for learning gathers all the elements of the environment that are linked to the

epistemic part of learning. This last component will allow the problem-solving situation to “react” in a relevant way, according to the targeted knowledge. The feedback accompanies the subject in the learning process, by provoking reinforcements, destabilisations, hints, scaffolding, etc.

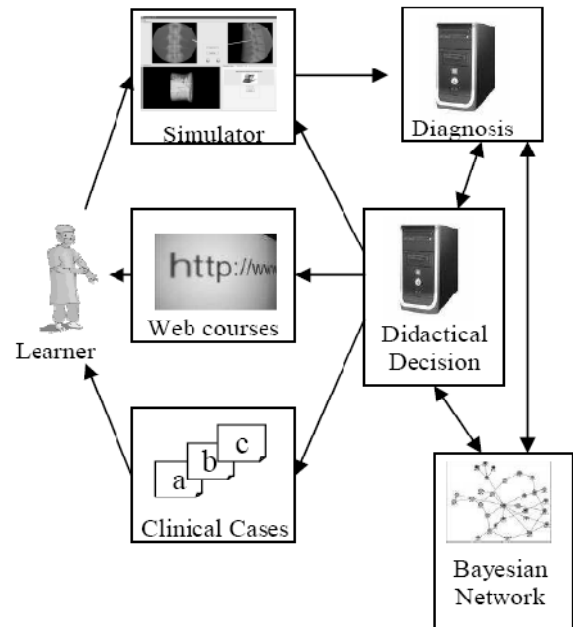

Figure 1. Architecture of the TELEOS Project

These research works involve the developing of a TEL platform Figure 1. in which a simulation agent has to reproduce accurately the elements characterizing a percutaneous orthopaedic surgery through a graphical and haptic interface.

Our TEL is designed with this objective: let the learner train himself freely on a percutaneous orthopaedic surgery in order to give him an epistemic feedback according to his actions.

The percutaneous orthopaedic surgeries can be divided into two distinct notions: the surgical act and the location of the surgical tool by using radiographies. Actually, during a minimally invasive surgery, the surgeon is able to

¹ The TELEOS project is supported by the CNRS and by the French research agency (ANR-06-BLAN-0243)

locate his tool's trajectory thanks to the radiographies taken all along the operation and thanks to the pressures felt during the progression of the tool in the body.

These are the two principal components that we are going to implement in the simulator, regardless of the type of operation simulated. Indeed, a percutaneous operation can concern various anatomical parts and requires various surgical tools. However, the success of that type of operation requires the realization of a precise movement. As in real situation, the surgeon has two cognitive indications, one visual, and the other kinesical. Therefore, we provide the learner with two interfaces, one graphical and one haptic, to let the learner immerse into a sensorimotor activity.

In this article, we are going to explain the foundations of the conception of TEL system, and especially, the description of how the simulation agent has been realized, this agent being trying to assimilate the characteristics of virtual reality: interaction, immersion, and autonomy.

II. DESCRIPTION OF THE SYSTEM

A. Functional specifications

1) Generalities

In order to encourage the extensibility and the re-usability of the software, we have chosen to take into account two kind of percutaneous operations in the simulator. These operations need a singular gesture and concern a distinct anatomic part: the vertebroplasty and the sacro-iliac screw. The first one is a spinal column operation which consists in injecting cement into a broken or a shrunken vertebra. The second one is a pelvis operation consisting in reducing and fixing the sacrum to the hip-bone.

In these two situations, the act can be done if the surgeon manages to locate his tool in the patient's body. To do so, two indicators are available: the radiographies and the pressures felt during the introduction of the tool in the body. These radiographies have needed to be validated after some adjustment on the fluoroscope (radiographies device).

Regardless of the simulated operation, the TEL system gives to the learner the opportunity to train himself to practise a surgical operation thanks to several functionalities:

- choose the type of patient and the type of operation,
- visualize in 3D the tool and the patient's model,
- draw the cutaneous marking off on the body of the patient's model,
- adjust the position and the incidence of the fluoroscopic image intensifier,
- produce and visualize radiographies,
- manipulate the surgical tool through an haptic interface.

The Figure 2. shows an outline of the graphical interface of the simulator. We can see at the top, two 2D images representing the last two radiographies produced by the user. On the bottom left hand corner, there is the 3D model of the patient, and the surgical tool. On the bottom right hand corner, we can see some graphical interface components such as a button or a cursor, to make some adjustments for the exercise.

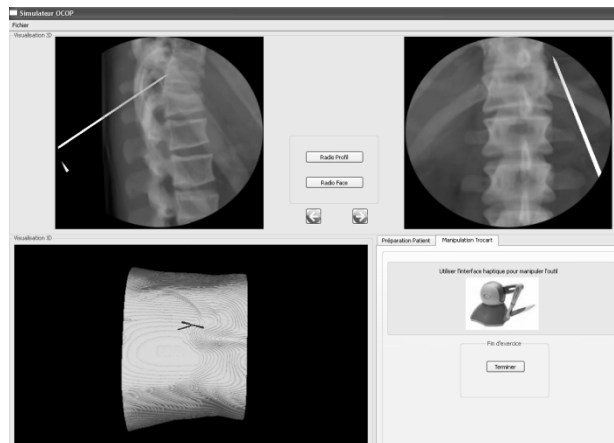

Figure 2. Simulator's graphical interface

Trails are produced during the problem solving activity in order to analyse the learner's behaviour. The gathered data processing is made by another application entity: the diagnosis agent [16]. This agent consults Bayesian networks in order to make a knowledge diagnosis of the learner's activity. A didactic decision agent [10] is also involved to make an epistemic feedback to the learner in accordance with the diagnosis that was made and with the information related to educational field. Depending on the diagnosis, the feedback can consist in another exercise to do with the simulator, in lessons to consult on the Internet or in clinical cases to study. These three entities, diagnosis agent, didactic decision agent, and Bayesian networks were based in a cognitive and didactic analysis of the surgeon activity [3], [15] formalised in the theoretical model $ck\phi$ [1]. This paper doesn't details this lasts agents more closely to artificial intelligence than virtual reality domain.

2) 3D window: patient's model

Our objective, in a learning point of view, is to propose a variety of patients' models which represented different cases that allows diverse solutions and problem solving strategies. Therefore, for the patient's model, the data used to create the volume comes from data files of real patients that had a scan before being operated. As a consequence, the simulator's 3D model will have a fractured, compressed, or slipped bone. The scanner produces a mass of snapshots, representing patient's transverse sections. These snapshots in DICOM format are gathered and used for 3D modelling. For the model to reach the highest quality, the scanner type must be a bodyscan, that is to say that all the body must be showed on the snapshots, and no injection must have been made to the patient because it would alter the tissue's aspect.

Using these transverse sections and taking the spaces between intra and inter sections into account, the 3D model can be created. To do so, the C++ VTK library

(*Visualization ToolKit*) [12] offers many classes to help designing 3D models. This library is slightly oriented towards medical field. By giving the same contrast to all snapshots from all models, we make sure that there is just one correspondence between the scalar value of the image's pixel and the density. The use of a ray tracing algorithm [11] [6] coupled with an isosurface algorithm allows us to examine the volume and to assign a graphical property to all the voxels whose scalar value corresponds to the founded values, the other voxels not being displayed. From the same model, we can obtain, in the same way, a volume with all the cutaneous surface or all the bony surface visible, as it is showed in the Figure 3. In the two situations, we assign a particular coloration according to the scalar value corresponding to the searched density.

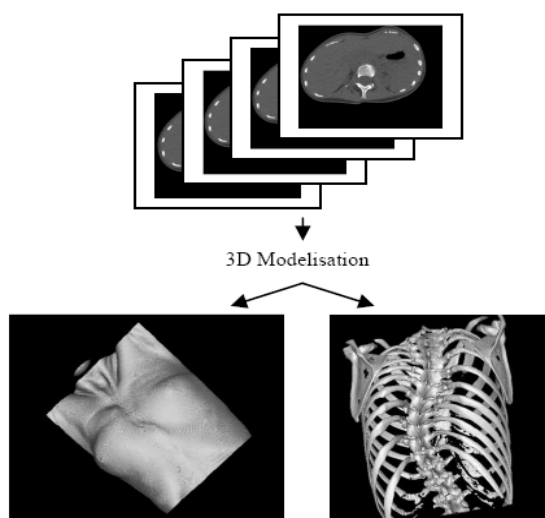

Figure 3. rendering surface skin and bone on a same model

3) 2D sight : patient's radiography

A radiographic image is a grayscale image with a number of transparency scales according to the tissues' density. Ray tracing algorithm [6] particularly meets the requirements to produce a radiographic image. But, contrary to rendering surface skin or bone, the use of an isosurface algorithm is not suitable. We are going to use a composition algorithm, considering different scalar values in order to assign distinct graphic rendering. Spacing grayscales out from the clearest to the darkest, and increasing the transparency gradually according to a higher density, we can obtain radiographic images, regardless of the volume examined, as shown in Figure 4.

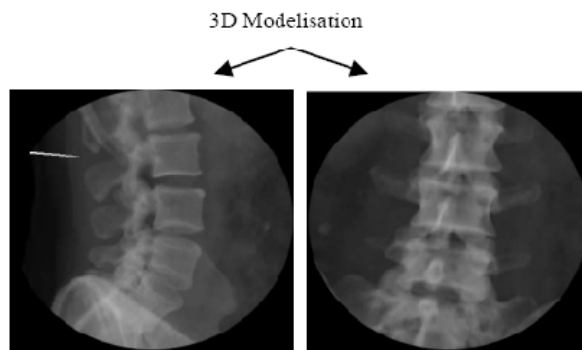

Figure 4. Frontal and profile radiographic reproductions on a same model

The radiographic reproduction obtained is a volume, as the model with the aspect of skin or bone also is. In order to obtain the frontal, inlet, outlet, and profile snapshots, we are simply going to change the camera's position, and the camera's focal position from the 3D scene, being the place where the radiographic volume and the tool are, and then we are going to record the rendering image. It is this image which is going to be displayed in the 2D image of the simulator. For example, a frontal snapshot would have its focal point behind the volume, and the camera would be placed orthogonally in relation to the focal, ahead of the volume. An inlet snapshot would be as effective as a frontal snapshot but the camera will be placed on a 35° angle from the orthogonal axis of the focal point.

All the positions are automatically determined proportionally to the size of the model. Thanks to some components of the simulator's graphical interface, the user can change the focal point's position (which also change the camera's position according to the same rules) and can make the angles of incidence vary on a precise axis. For instance, to make a radiography profile, the ray incidence can be changed relatively to cranio caudal axis and AP axis. This time again, there are just modifications of the 3D scene camera's position. All these adjustments of the position and of the incidence ray simulate the adjustment that could be made on the fluoroscopic image intensifier. The rendering of 2D radiography includes these adjustments in order to fix an image from the volume.

B. Technical specifications

1) Device

The haptic interface used by the simulator is the Phantom Omni from Sensable. This is the market's most affordable product. It offers six degree-of-freedom positional sensing, with a force feedback arm. The forces generated by this device are quite low (maximum 3.3 Newton) and do not correspond to the real forces exerted [9]. Nevertheless, these forces are enough low to be used in a lower scale for learning [15]. The use of this device is effective to account for different human body's densities, especially different densities between the cortical and the spongy bones.

The technical limits of the Phantom Omni, related to the fact that the force feedback on the rotation axis is not taken into consideration, must be overcome by a physical device. Indeed, even if it is not necessary to give a

feedback force on the tool's rotations, we must lock the stylus orientation's direction as soon as it is introduced in the body. To do so, we are going to use a needle in extension of the stylus as illustrated in the Figure 5. , and a simulation box made from a PVC box, two PVC lids, four PVC screws and polyether foam. Since the simulator let the learner train himself freely, we cannot conceive a model as [5], because the cutaneous entry point is fixed in their solution.

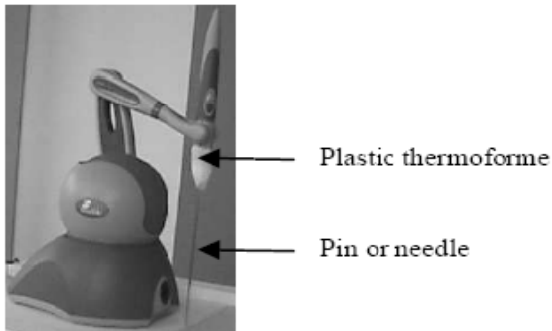

Figure 5. Extension of the haptic stylus interface

The foam is set out between the two lids, the screws tighten the box with the two lids. The distance between the stylus' needle and the foam must be calibrated with the distance of the tool's initial position in the 3D image and the volume. In this way, when the tool is introduced in the body, the needle having gone through the foam is locked in its orientation's direction. This locking can be explained by the accumulation of the force exerted on the translations and by the resistance of the foam's physical support. The Figure 6. shows the whole device.



Figure 6. Device

C. Software architecture

The force feedback interfaces use libraries developed in C++ and are based on the graphic library OpenGL, the Phantom Omni is also concerned. In order to reach the higher performance, and to avoid the simulator and its haptic peripheral to interface by using a framework, we have chosen to develop the simulator in C++ and to select display libraries based on OpenGL. This language choice has no impact on the other TEL agents as they are

connected to each other by web services, thus ensuring the interoperability.

The Figure 7. shows the software architecture of the simulator. We can see the libraries used, all developed in C++, libraries needing a graphic rendering being based on OpenGL.

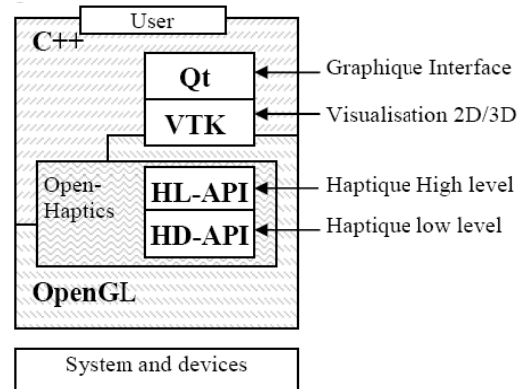

Figure 7. Software architecture of the simulator

III. TOWARDS AN IMMERSIVE INTERACTION

A. Pseudonatural immersion

During the simulation of a surgical operation, in order to immerse the learner, we synchronize the learner's sensations by harmonizing the senses of touch and of sight. This system of immersion is composed of graphical and haptic interfaces.

Pseudonatural immersion consists in setting the learner standing in front of the graphic and haptic interfaces (Figure 8.). The two interfaces make possible an interaction with the system. The haptic interface offers the opportunity to immerse into the 3D manipulation of the virtual object of the surgical tool thanks to physical manipulation of the stylus. The graphical interface is used to visualize virtual objects and to make adjustments for the operation to be successful.

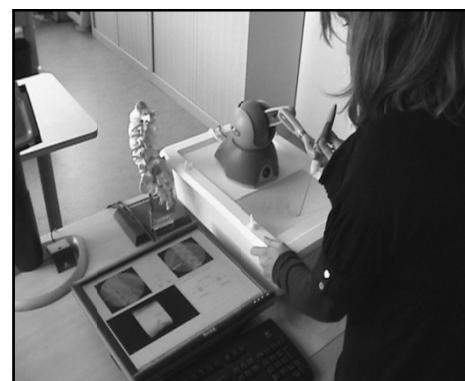

Figure 8. User in learning situation

B. Interaction

The learner's interaction with the simulator is insured by the graphical and haptic interfaces.

Figure 9. illustrates the exchanges between entities. The user manipulates the mouse and/or the haptic interface.

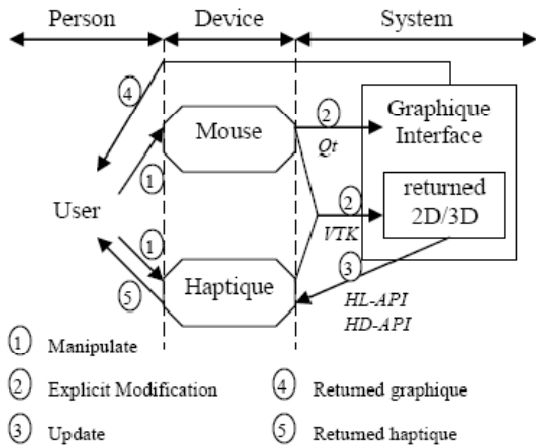

Figure 9. : Interaction Person/System

With the mouse he can modify directly the graphical interface, for example by activating some buttons, or by shifting cursors. The Qt library is required as its signal and slot system simplifies the factual management. The user can also change the 3D scene using the VTK library to calculate in real time the 3D objects' transformations. The graphical interface modifications can alter the 2D and 3D result, like, for example, when the user makes a 2D radiography.

With the haptic interface, the user physically modifies the stylus' position and orientation, as he would do manipulating a surgical instrument during an operation. The rotations and translations undergone by the stylus are directly retransmitted visually in the 3D graphic rendering of the simulator. At the same time, according to the body's density, a force feedback is produced by the device. As a consequence, we differentiate the graphic rendering from the haptic rendering. A timer is in charge of the realization of these two renderings. It takes one tenth of second. The visual and tactile result seems fluent for the user and does not imply visible latency.

The graphic rendering consists in determining the vector's position and the quaternion of the stylus orientation by using haptic libraries, in converting these data into a transformation matrix, as expressed in VTK, and finally consists in applying this matrix to the 3D sight tool (Figure 10.).

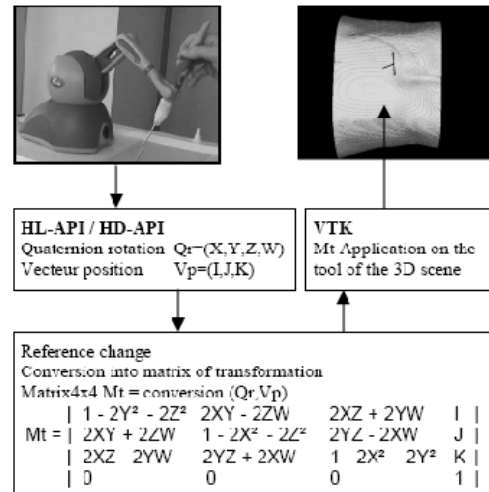

Figure 10. Graphic rendering

The haptic rendering does not follow the same path. In the 3D sight, we are looking for the contact point between the tool and the model, and then we determine the voxel's scalar value corresponding to the contact point on the model. Finally, we balance the force to feedback by the haptic interface according to the scalar value returned (Figure 11.) in relation to Hounsfield's scale [4].

Currently, the force feedback function is linear: the more concentrated is the body in contact, the more important is the force to feedback. When there is no contact, the force is null. However, it is important to know that this function is not definitive; it could change thanks to the data drawn from sensorimotor experimentations. We can easily imagine that a friction effect must be implemented in the function. Thus, the point would be to keep the highest density encountered during the trajectory in memory and to balance this maximum according to the distance covered since the encounter.

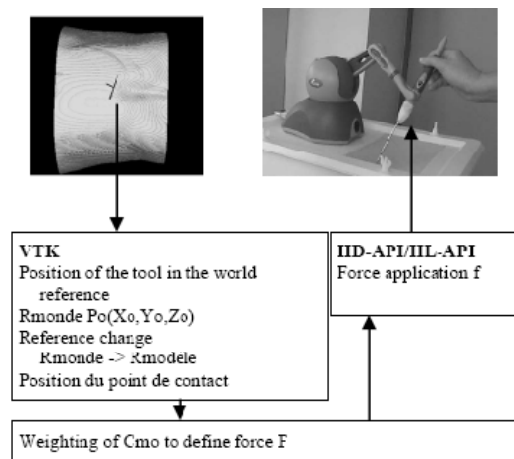

Figure 11. Haptic rendering

C. Autonomy

The user's autonomy rests in his capacity to coordinate his perceptions and his actions during the interaction with others entities' process [13]. Our goal being to enable the learner to train himself freely and to allow him to make mistakes, the concept of autonomy is a crucial characteristic of our simulator.

IV. TOWARDS AN EPISTEMIC RETROACTION

The original approach of our TEL is based on the interest of producing epistemic retroactions [8]. Instead of bringing the knowledge representation around to an expert model, we establish a knowledge model from the experimental data manipulated since this expert model has been explicitly represented. As a consequence, our system must enable the construction of a reasoning based on revisable knowledge that could evolve during the interaction.

From empirical, inferential and perceptivo-gestural knowledge elicitation, experimentations are developed in order to evaluate and quantify the knowledge required during an operation. These cognitive and perceptivo-gestural experimentations generate different types of experimental data. This data must be processed through Bayesian network whose structure is established according to the expert model and whose parameters would be calculated from the data learning, the study of learning algorithms being done. The goal is to provision Bayesian networks that will be used by the diagnosis agent to set up a report according to the learner's exercise and by the didactic decision agent to evaluate the feedback method and content.

From the simulator's conception point of view, it is essential to take the concept of trace into account for the diagnosis to be made. So, from this knowledge model, we are going to define the data acquisition process, the kind of traces to find, the data that must be included, and the events currently occurring at the root of their creation.

A. Data acquisition process

We have seen that the 3D model was made from a real patient's DICOM files. This step belongs to a unique procedure for each model of patient. It also includes segmentation steps used to find traces. The knowledge model underlines the anatomic parts that need to be segmented in sub-volume or in interest point in order to record the interest point's position in a text file. The goal is to make some areas identifiable and to take them into account in the kinematics of the patient's gesture. This last step of data acquisition process enables the simulator to have data in order to evaluate some of the operation's events, which permit to give the learner a feedback on his exercise.

B. Collected trails

For each new exercise, whether it is Sacro-iliac screw or vertebroplasty, the user selects the 3D model that is going to be used for the exercise. When a user realizes an exercise, a file containing the generated traces is created. The traces include information about the model chosen, and about the user's data, all dynamically generated by some events.

C. Model's data

When a user begins a new exercise and selects one of the 3D models proposed by the simulator, a trace file is created. The metadata model's, such as the operated vertebra's number or the patient gender and age, are first recorded. Then, all the interest points underlined during the data acquisition process are located.

D. Generating event

Each significant action of the user will generate traces. We consider two kind of events, the direct events, directly related to the user's action on the graphical interface, and the indirect events, which are related to the model's state.

For the direct events, we associate the user's interaction on the graphical interface with an event generating traces. For example, when the user presses the button « Radio Profile », the trace record for the user data is activated.

Most of the characteristic actions can be identified as such thanks to a direct action of the learner on the graphical interface. In other situations, the state of the collision between the tool and the model will be studied, particularly the cutaneous and the bony entry point. To locate these two events, we use the voxel's scalar value corresponding to the collision point between the tool and the volume. This scalar value is known all along the exercise. For example, the first time this value exceed zero, the tool get in contact with the body, this corresponds to the cutaneous entry point. In the same way, the first time this value is equal or superior to the value corresponding to a cortical bone's density, this is the bony entry point.

E. User's data

When a significant action from the user is detected, data relative to the user is recorded in the traces file. These are elements that could have been altered by the user. It can be adjustments, force exerted, speed, but also, more generally, chronological order or redundancy of the actions.

For example, the learner can adjust the fluoroscope's position and its incidence rays, this action altering directly the radiographies.

Thus, for each radiography, the simulator records the position of the camera and the focal. All the information, with the model's data about some interest points could be used by the diagnosis agent to determine the knowledge required during the modifications made by the learner.

Concretely, when realizing a frontal radiography in vertebroplasty, it is important to check that the pedicles are located symmetrically in relation to the thorny. In this case the generating event is the user's interaction on the graphical interface component « Generate Radio Frontal ». The useful model's data are the interest points right pedicle, left pedicle and thorny. The user's data needed for the diagnosis are the camera's position and the focal's position. The diagnosis agent will make a conic projection of the model's points on the orthogonal plan in the camera's position and focal's position segment and will check the projected points are symmetrical.

F. Exercise

In order to ensure the learning's continuity, the user's information must be saved and must remain available after the exercise. With this simulator, it is possible to record an exercise in progress and to open a past exercise.

An XML file is created to make the record. It includes all the information related to the exercise, such as the operation type, the model used, the traces file's references, the adjustments made on different shots, etc.

In the same way, when an exercise is opened, the XML file is read to collect all the information and apply the adjustments. An exercise is opened exactly the way it was when saved.

V. EVALUATION AND DISCUSSION

The current version of the TEL system includes a finalised version of the simulator and intermediate versions of Bayesian networks, diagnosis and didactic decision agents.

Our architecture and methodology allow us a progressive validation. Indeed, we are able to validate each agent separately. For the student learning resources, the computer representations are a close world well specified. Consequently, the validation is related to the completeness, correctness and the usability factors.

For the knowledge domain, the model has to take into account the evolution of the knowledge extraction. The validation is related to the expressiveness and the adequacy factors.

For the empirical dimension (diagnosis and didactical decision agents) we define a gold standard validation where we define a set of scenarios with a set of correct (input, output) pairs. Finally for the decision agent, we propose a sensitivity analysis: checks whether the best decision is sensitive to small changes.

We specify and validate our computer models in interaction with two kinds of experts (medical and didactical).

The simulator's functions reliability has been demonstrated by the methods used for its conception:

- To train oneself using real data. The used data's coherency is guaranteed by the data acquisition process for the construction of 3D models.
- Evaluate intelligible radiographies. The principle of radiography generation guarantees the homogeneity of the 2D rendering, in spite of the variability of the models.
- Insure a perceptual coherence. The graphic rendering is in accordance with the haptic rendering.
- Insure a major educational interest, thanks to the integration of the simulator in the TEL system.

Our first validations, with the medical' experts, show that, for the mouse mode, the usability and correctness properties seem in accordance with the expected ones, i.e. for learning use. For the haptic mode, these fits test shows some correctness problems due our physical device. Indeed, the needle added is not perfectly aligned with the Omni' pen. Consequently there are a gap between the physical model and the 3D model.

Otherwise, the preliminary evaluations with the didactical experts show that the completeness factor seem in accordance with the learning scenarios proposed.

These validations allow us to install the stable version in the hospital and currently we prepare two experimentations in order to evaluate it in ergonomic and learning points of views.

REFERENCES

- [1] Balacheff, N. «Les connaissances, pluralité des conceptions. Le cas des mathématiques.» *Les Cahiers Leibniz*. février 2001. <http://www-leibniz.imag.fr/LesCahiers> (accès le avril 2009).
- [2] Brousseau, G. «La théorie des situations didactiques.» *Cours donné lors de l'attribution du titre de Docteur Honoris Causa de l'Université de Montreal*. Montreal, juin 1997.
- [3] Ceaux, E., L. Vadcard, M. Dubois, et V. Luengo. «Designing a learning environment in percutaneous surgery: models of knowledge, gesture and learning situations.» *European Association for Research on Learning and Instruction*. Amsterdam, 2009.
- [4] Hounsfield, G. N. «Computerized transverse axial scanning (tomography): Part 1. Description of systemol.» *Br. J. Radiol.*, 1973: 1016–1022.
- [5] Kwon, D.-S., et al. «Realistic Force Reflection in a Spine Biopsy Simulator.» *IEEE International Conference on Robotics and Automation*. 2001. 1358–1363.
- [6] Levoy, M. «Efficient ray tracing of volume data.,» *ACM Transactions on Graphics*. Stanford University, 1990. 245-261.
- [7] Luengo, V, A Abouafia, A Blavier, G Shorten, L Vadcard, et J Zottmann. «Novel Technology for learning in Medicine.» Dans *Technology Enhanced Learning. Principles and products.*, de N, Ludvigsen, S Balacheff, T de Jong, A Lazonder et S Barnes, 105-120. Berlin: Springer Verlag, 2009.
- [8] Luengo, V. «Take into account knowledge constraints for TEL environments design in medical education.» *International Conference on Advanced Learning Technologies*. Santander: Springer, 2008. 5 pages.
- [9] Matsumiya, K., et al. *Analysis of Forces during Robotic Needle Insertion to Human Vertebra*. Heidelberg, Allemagne: Springer-Verlag, 2003.
- [10] Mufti-Alchawafa, D., V. Luengo, et L. Vadcard. «A decision-making process to produce adaptive feedback in learning.» *International Conference on Human System Learning*. Toulouse, 2008. 8 pages.
- [11] Roth, S.D. «Ray casting for modeling solids.» *Computer Graphics and Image Processing*, 1982: 109-144.
- [12] Schroeder, W., K. Martin, et B. Lorensen Schroeder. *The Visualization Toolkit: An Object Oriented Approach to 3D Graphics 3rd Edition*. Kitware, Inc. Publisher., 2003.
- [13] Tisseau, J. *Réalité virtuelle : autonomie in virtuo.* . Rennes, France: Thèse en informatique, Université de Rennes I, 2001.
- [14] Vadcard, L., et V. Luengo. «Réduire l'écart entre formation théorique et pratique en chirurgie : conception d'un EIAH.» *Environnements informatiques pour l'Apprentissage Humain*. Montpellier: INRP, 2005. 129-140.
- [15] Vidal, F. P., N. Chalmers, D. A. Gould, A. E. Healey, et N. John. «Developing a needle guidance virtual environment with patient-specific data and force feedback.» *International Congress Series 1281, University of Wales, Bangor Manchester Royal Infirmary, Royal Liverpool University Hospital*. 2005.
- [16] Vu Minh, C., V. Luengo, et L. Vadcard. «A Bayesian Network Based Approach for Student Diagnosis.» *Information and Communication Technologies in Higher Education and Industry*. 2006. 6 pages.