



HAL
open science

3D Heterogeneous Integration of Wireless Communicating Nano-Sensors on Flexible Substrate

Mohamed Mehdi Jatlaoui, Daniela Dragomirescu, Samuel Charlot, Patrick Pons, Hervé Aubert, Robert Plana

► **To cite this version:**

Mohamed Mehdi Jatlaoui, Daniela Dragomirescu, Samuel Charlot, Patrick Pons, Hervé Aubert, et al.. 3D Heterogeneous Integration of Wireless Communicating Nano-Sensors on Flexible Substrate. SPIE - Advanced Topics in Optoelectronics Microelectronics and Nanotechnologies, Aug 2010, Constanta, Romania. pp.78211. hal-00591024

HAL Id: hal-00591024

<https://hal.science/hal-00591024v1>

Submitted on 6 May 2011

HAL is a multi-disciplinary open access archive for the deposit and dissemination of scientific research documents, whether they are published or not. The documents may come from teaching and research institutions in France or abroad, or from public or private research centers.

L'archive ouverte pluridisciplinaire **HAL**, est destinée au dépôt et à la diffusion de documents scientifiques de niveau recherche, publiés ou non, émanant des établissements d'enseignement et de recherche français ou étrangers, des laboratoires publics ou privés.

3D Heterogeneous Integration of Wireless Communicating Nano-Sensors on Flexible Substrate

M. M. JATLAOUI^{1,2}, D. DRAGOMIRESCU^{1,2}, S. CHARLOT^{1,2}, P. PONS^{1,2}, H. AUBERT^{1,2},
R. PLANA^{1,2}

1 CNRS; LAAS; 7, avenue du Colonel Roche, F-31077 Toulouse, FRANCE

2 University of Toulouse; UPS, INSA, INP, ISAE, LAAS; F-31077 Toulouse, FRANCE

ABSTRACT

In this communication, the 3D heterogeneous integration of miniaturized communicating modules used for wireless network application is described. These communicating objects present the particularity of being in Nano-scale range. In fact, each object is composed of Nano-sensors, transceivers and E/R antenna. Such investigated ways of Nano-system integration will allow the development of sensor communicating modules which can be inserted and located in areas with access difficulty (in particular in non planar area) or even in inaccessible places. This attractive integration concept is discussed and illustrated here.

Keywords: 3D Heterogeneous Integration, Nano-Objects, Flexible Substrate, Flex Assembly, Wireless sensor networks.

1. INTRODUCTION

The “Internet of thing” domain arouses many research efforts in Europe and in the world [1]. This domain aims at spreading ultra miniaturized sensor networks presenting the most low consumptions and offering the advantage of being localized in areas with access difficulty (in particular in non planar area) or even in inaccessible places, with conventional technologies. Designers have exploited the inherent flexibility to design flex circuits to be flexurally deformed during assembly, adjustment, and repair procedures, to have complex three-dimensional final geometries, and to sustain multiple flexural cycles during functional life [2]. Taking into account the integration in difficult access zones, it is recommended to exploit the potentialities of nano-objects for wireless nano-components realization. Nanotechnologies made it possible the development of ultra-sensitive nano-sensors based on nano-particles deposition [3-4]. Transceivers become more and more miniaturized and one can investigate assembly techniques to postpone them on flexible substrate. One can also take benefits from nano-ink with silver nano-particles or with nanotube of carbon to develop antennas on flexible substrate. These antennas can be directly integrated on the same flexible substrate as the developed nano-sensors and miniaturized transceivers, which is the very innovative approach of this work.

How, then, does one choose an assembly process and method for flex circuits? To begin appropriately, it is necessary to consider a number of important parameters: What is the flex circuit base material? What types of components will be used? How many assemblies will be built? These and other important questions must be addressed before one can adequately make the proper decisions regarding assembly. In the following sections, answers to these questions are proposed.

2. DESCRIPTION OF THE COMMUNICATING NANO-OBJECT

For the development of reliable and reconfigurable communication architectures, the aeronautical domain imposes severe specifications dealing with the reliability, the electromagnetic compatibility, the interferences immunity, the consumed power and the determinism of protocols. From the system integration point of view, the research work presented here aims at assembling various elements constituting the communicating nano-object (as shown in Figure1): nano-sensors, transceivers and E/R antenna. For that purpose, an innovative solution will be developed. This solution consists in the integration on flexible substrate of these various components realized in different technologies. The nano-sensors are based on nano-particles deposition. The sensor can be done directly on the flexible substrate or on silicon and then reported on the flexible substrate. Different kind of sensors can be integrated on this substrate, as constraint gauge [5], crack wire or chemical / humidity detection sensor [6]. The transceivers are composed of mixers, VCOs and LNAs realized in 65nm technology. These components will be reported on the substrate by flip-chip. Finally, the antenna made of CNTs ink deposition and designed at 60 GHz is directly printed on the substrate. The 60 GHz frequency is chosen for the short connections and the very short distances to limit multi-path effect and to minimize the energy losses induced by the dispersive radiation pattern. Here, the challenge deals with the choice of the flexible substrate, the pads materials and the interconnection architecture to minimize the RF losses and parasitic effects. This paper brings the first response elements and presents a proof of concept for such heterogenous integration.

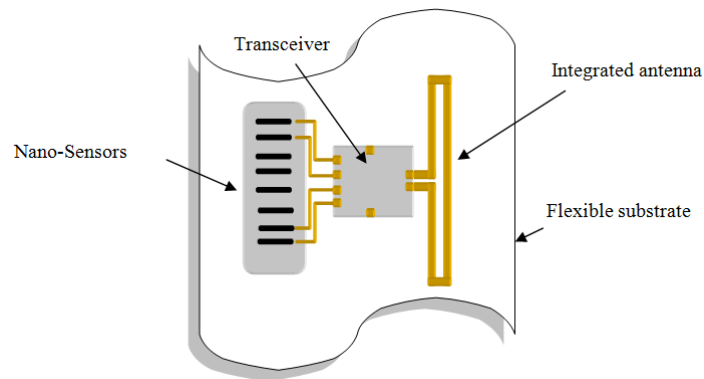

Fig. 1 Concept of the communicating nano-object on flexible film

3. FLEX CIRCUIT BASE MATERIAL AND CIRCUIT DESIGN

As mentioned in the previous section, the communicating nano-object is composed of various components realized in different technologies. Each component has specific constraints: Indeed, the nanosensors impose constraints on the roughness, mechanical properties and surface condition. As for Transceiver and antennas, they require good thermal properties (for the postponement by FlipChip) and good RF properties (to minimize the parasitic effect, for the RF interconnections). Based on these criteria, two solutions can be envisaged. The first is to achieve a postponement on a same substrate but with the need for an intensive study to improve the surface condition. The second solution is to make the sensor on a flexible substrate first and then the transceiver and antenna are added on a second substrate.

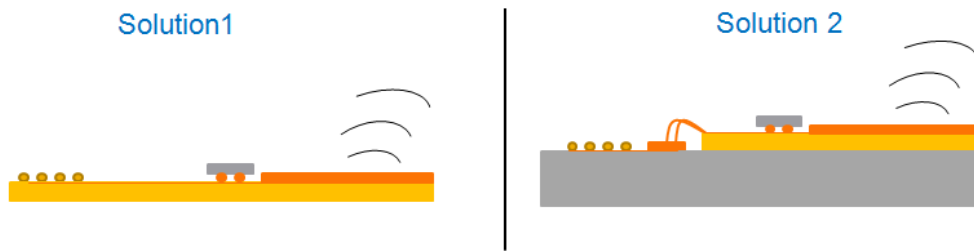

Fig. 2 Selected solutions for the assembly

In order to demonstrate the feasibility of such integration, the second solution was chosen for the remainder of this paper. For the nanosensors, the selected substrate is PET. This substrate has a good surface state. However, a $130\mu\text{m}$ Kapton substrate was chosen for the transceiver and antennas because of its good RF and thermal properties. For physical, thermal properties and effect of humidity please refer to [7]. After achieving, the components follow a variety of tests. In a first step, non-destructive flaw detection means will be used to check if all the bumps are connected properly and that there is no breaking problem between the chip and substrate. RF tests and tests to characterize the bumps resistivity are also planned (Daisy chain, four probe method). To perform these tests, circuits on Kapton were designed to receive the chip after postponement by FlipChip. Given the cost of chips made with 65nm technology, VCOs and LNAs dummies must also be manufactured. Some of the designed circuits (on kapton and on Silicon) are shown in figure 3.

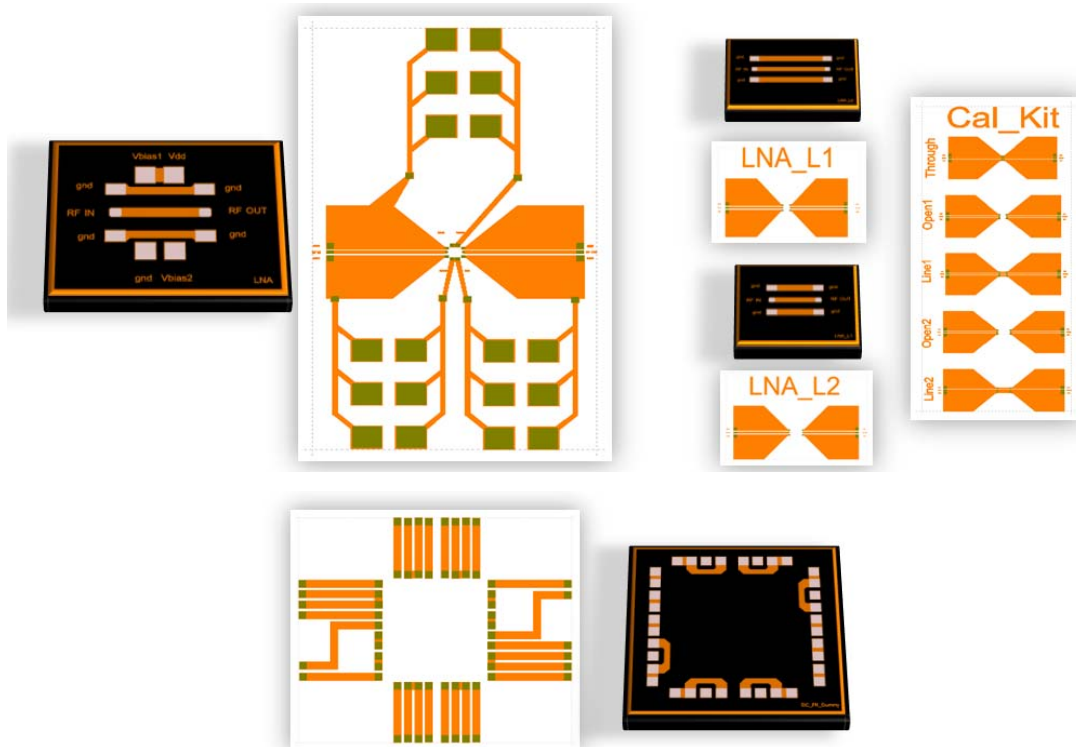

Fig. 3 Designed circuits on Kapton and Silicon dummies (VCOs, LNAs and Daisy chain chip)

4. ASSEMBLY PROCESS

For the work reported here, a polyimide flexible substrate made of Kapton is chosen. Packaging of the transceivers and the Nano-sensors on the Kapton film is schematically illustrated in Figure 4. First, a polymer spin coating is performed for the adhesion of the polyimide on the holding wafer. Second, polyimide was patterned on the substrates by lamination. The polyimide is a Kapton film with a 130 μm thick. Third, resin lift spin coating is realized. Fourth, a photolithography is done for the Cu/Ni/Au UBM metallization placement. The UBM metallization is realized by lift-off. Finally, after a passivation layer deposition, soldering screen printing and reflow are performed before the substrate peeling. The different elements interconnections are performed using Cu lift off process.

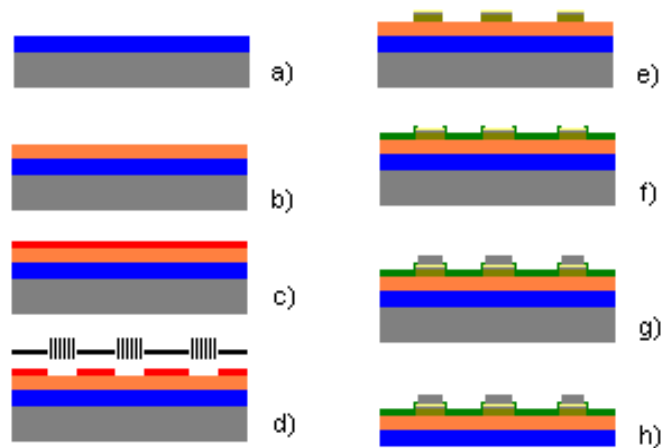

Fig. 4 Processing methods for copper circuits (a) polymer spin coating for the adhesion; b) polyimide lamination; c) resin lift spin coating; d) photolithography; e) Cu/Ni/Au UBM metallization resin stripping by lift off; f) passivation layer; g) soldering screen printing and reflow; h) substrate peeling)

5. REALIZED TEST STRUCTURES

Adopting the process shown in the previous section, test structures were performed. In figure 5, realized circuits on kapton are presented. One can see the location for the postponement of the dummy chip (VCO or LNA) with the passivation layer.

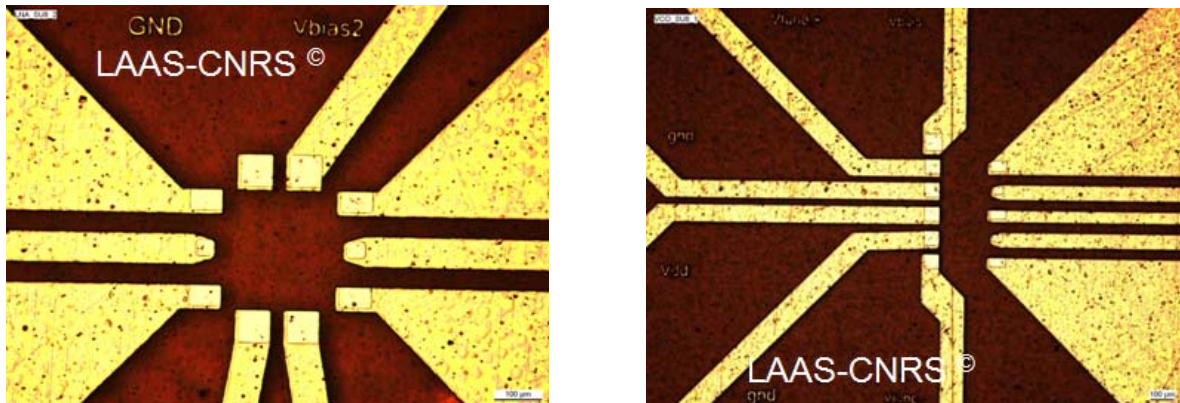

Fig. 5 Realized circuits on Kapton (location for the postponement of the dummy chip)

In a first step, the antennas on kapton have been performed separately following the same assembly process. One can see from the figure below (Figure6), different patch antennas made on Kapton. One can also distinguish resonant circuits that are capable of measuring the real permittivity of Kapton. This value will be used for permittivity retro-simulations and the future design of interconnections between the RF Transceiver and antennas.

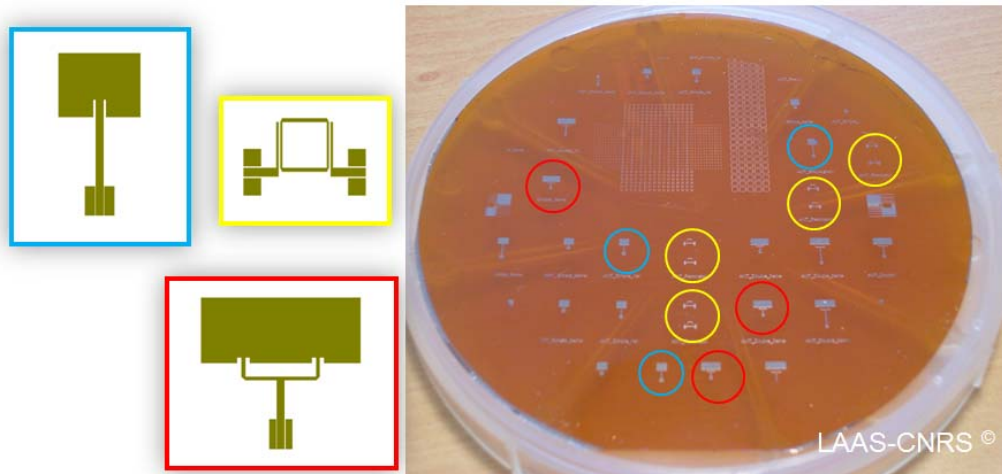

Fig. 6 Realized antennas and resonators on Kapton

Dummy chips were also fabricated. These chips have the same access that real components, but with connections to allow RF tests. On Figure 7, one can see the diced dummy chips on which stubbumps were deposited.

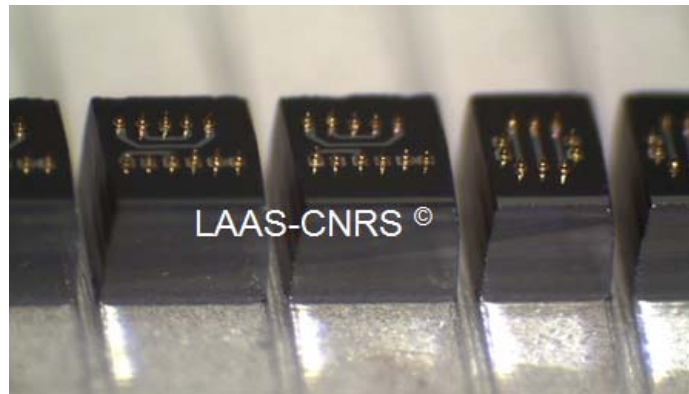

Fig. 7 Realized Silicon dummies (VCOs and LNAs)

The first assembly tests were carried out. As shown in Figure 8, a dummy chip (LNA) has been postioned on a circuit on Kapton. The first tests were carried out visually. No problems were detected.

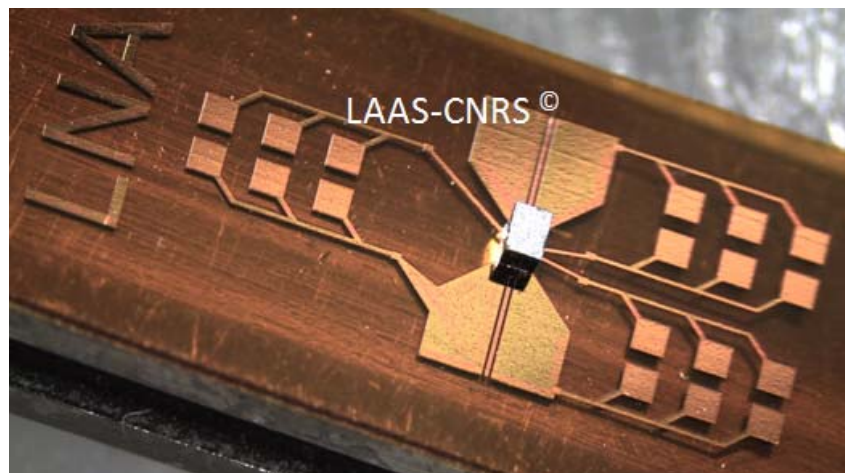

Fig. 8 First assembly tests (LNA Dummy on Kapton)

6. CONCLUSION

Flexible circuit technology opens doors to new opportunities for engineers and system designers to make a complete transition to the 3D interconnection. Flexible circuits are obviously unique among electronic packaging technologies to offer a wide variety of solutions where compactness and heterogeneous integration, of different components on the same substrate, are needed. In this paper the very first and unique results presenting the potentialities of flexible substrate for the heterogeneous integration of communicating Nano-Objects are presented. The choice of the technological process (selection of materials and choice of process technology) has been discussed. The design and fabrication of test structures for the verification of the RF interconnections quality have been made. The design and implementation of antennas on Kapton substrate was also performed. Future works will address the characterization of the realized structures under real working conditions. Real case applications (on aeronautical composite

components) are being investigated by the authors to bring a proof-of-exploitation of these new wireless Nanosensor nodes.

Acknowledgments

This work has been supported by the French National Research Agency (ANR) in the frame of its program "Recherche Technologique Nano-INNOV/RT" (NANOCOMM project n°ANR-09-NIRT-004).

REFERENCES

- [1] D.Dragomirescu, M.Kraemer, M.M.Jatlaoui, P.Pons, H.Aubert, A.Thain, R.Plana "Wireless Communicating Nano-Objects for Structure Health Monitoring as Enabler for Safer, Greener Aircrafts" , Proceedings of International Conference Advanced Topics in Optoelectronics, Microelectronics and Nanotechnologies (ATOM-N 2010), Constanta August 2010.
- [2] Joseph fjelstad, Flexible circuit Technology, third edition, 2006
- [3] T. Reda, G. R. Baxter, B. Raguse, G. J. J. B. de Groot, R. Chai, M. Roberts, and L. Wiczorek, *Applied Physics Letters* 91, 183105 (2007)
- [4] T. Vossmeier, C. Stolte, M. Ijeh, A. Kornowski, and Horst Weller, *Adv. Funct. Mater.* 18, 1611 (2008)
- [5] L.Ressier, E.Palleau, C.Garcia, G.Viau et B.Viallet, "How to control AFM nanoxerography for the template monolayered self-assembly of 2 nm colloidal gold nanoparticles", *IEEE Trans. on Nanotechnology* no.4, pp. 487-491, 2009
- [6] P. Temple Boyer, A. Benyahia, W. Sant, M.L. Pourciel-Gouzy, J. Launay, A. Martinez : "Modelling of urea-EnFETs for haemodialysis applications", *Sensors and Actuators*, vol 131/2 (2008), p.525-532
- [7] Dupont Corporation, http://www2.dupont.com/Kapton/en_US/assets/downloads/pdf/summaryofprop.pdf