



HAL
open science

Optimal Generation of Space-Time Trellis Codes via Coset Partitioning

Pierre Viland, Gheorghe Zaharia, Jean-François H elard

► **To cite this version:**

Pierre Viland, Gheorghe Zaharia, Jean-Fran ois H elard. Optimal Generation of Space-Time Trellis Codes via Coset Partitioning. IEEE Transactions on Vehicular Technology, 2011, 60 (3), pp.966-980. <10.1109/TVT.2011.2112678>. <hal-00588978>

HAL Id: hal-00588978

<https://hal.science/hal-00588978v1>

Submitted on 27 Apr 2011

HAL is a multi-disciplinary open access archive for the deposit and dissemination of scientific research documents, whether they are published or not. The documents may come from teaching and research institutions in France or abroad, or from public or private research centers.

L'archive ouverte pluridisciplinaire HAL, est destin e au d p t et   la diffusion de documents scientifiques de niveau recherche, publi s ou non,  manant des  tablissements d'enseignement et de recherche fran ais ou  trangers, des laboratoires publics ou priv s.



HAL Authorization

Optimal Generation of Space-Time Trellis Codes via the Coset Partitioning

Pierre Viland, Gheorghe Zaharia, *Member, IEEE* and Jean-François Héland, *Senior Member, IEEE*

Abstract—Criteria to design good space-time trellis codes (STTCs) have been already developed in previous publications. However, the computation of the best STTCs is time-consuming because a long exhaustive or systematic computing search is required, especially for a high number of states and/or transmit antennas. In order to reduce the search time, an efficient method must be employed to generate the STTCs with the best performance. In this paper, a technique called coset partitioning is proposed to design easily and efficiently optimal 2^n -PSK STTCs with any number of transmit antennas. The coset partitioning is an improved extension to multiple input multiple output (MIMO) systems of the set partitioning proposed by Ungerboeck. This extension is based on the lattice and coset Calderbank's approach. With this method, optimal blocks of the generator matrix are obtained for 4-PSK and 8-PSK codes. These optimal blocks lead to the generation of the STTCs with the best Euclidean distances between the codewords. Thus, new codes are proposed with 3 to 6 transmit antennas for 4-PSK modulation and with 3 and 4 transmit antennas for 8-PSK modulation. These new codes outperform the corresponding best known codes. Besides, the first 4-PSK STTCs with 7 and 8 transmit antennas and the first 8-PSK STTCs with 5 and 6 transmit antennas are given and their performance is evaluated by simulation.

Index Terms—Space-time trellis coding, MIMO system, coset.

I. INTRODUCTION

Trellis-coded modulations (TCMs) combine modulation and coding to obtain a high time-diversity scheme to improve the performance or the data rate of wireless systems. Ungerboeck proposed a method called set partitioning to design TCMs for single input single output (SISO) systems in [1], [2], [3]. An alternative of the set partitioning is given by Calderbank *et al.* in [4]. With their method, the symbols are divided into cosets instead of sets, as the set partitioning does. This coset approach is simpler than the set partitioning for large constellations.

In 1998, Tarokh *et al.* introduced the concept of space-time trellis codes (STTCs) [5]. STTCs achieve both diversity and coding gain on multiple input multiple output (MIMO) fading channels by coding over multiple transmit antennas.

In [5], the first criteria called the rank and the determinant criteria are presented to govern the performance of STTCs over slow Rayleigh fading channels. In the case of fast Rayleigh fading channels, criteria based on the Hamming distance and the distance product are also proposed. For slow and fast Rayleigh fading channels, when the product between the number of transmit antennas and the number of receive antennas is important, Chen *et al.* in [6] and Yuan *et al.* [7] showed that the minimum Euclidean distance (ED) between two codewords governs the code performance. This criterion called ED criterion (or trace criterion) is also advocated by Ionescu in [8] and [9]. Biglieri *et al.* in [10], [11] also showed that the performance of STTCs is determined by the ED criterion when the number of transmit and receive antennas is large. This configuration corresponds to a great number of independent sub-channels.

The main difficulty to generate the best codes is the long search duration. An exhaustive search can be employed for a small number of transmit antennas. Thus, many 4-PSK STTCs with 2 transmit antennas have been proposed via an exhaustive search in [12], [13]. In the case of 3 and 4 transmit antennas, Chen *et al.* used a suboptimal method in [6], [14], [15]. In [16], Bernier *et al.* used a random search to find the best STTCs. In order to reduce the search time of the STTCs with the best performance, Yan and Blum in [17] described a method to compute efficiently the coding gain and proposed new 2-PSK and 4-PSK STTCs. Abdool-Rassool *et al.* gave the first 4-PSK STTCs with 5 and 6 transmit antennas, via a systematic search [18], [19].

In order to reduce the search time, an efficient method to generate the best STTCs must be employed. For example, with an exhaustive search, 4 billions of 4-state 4-PSK STTCs with 4 transmit antennas must be analyzed. The number of codes increases drastically with the number of states, the modulation complexity and the number of transmit antennas. For example, if one antenna is added to the previous example, the number of 4-state 4-PSK STTCs with 5 transmit antennas is approximately 10^{12} . Hence, this paper proposes a general method called coset partitioning to generate the best 2^n -PSK STTCs without the time-consuming exhaustive and

systematic search. This method is based on the lattice and coset Calderbank's approach and can be seen as an important extension to MIMO systems of the set partitioning proposed by Ungerboeck.

This paper is organized as follows. In section II, the representations of STTCs are reminded. Section III describes the existing code design criteria. In section IV, the coset partitioning is presented and design examples are given. Section V gives new 4-PSK STTCs with 3 to 8 transmit antennas and 8-PSK STTCs with 3 to 6 transmit antennas, designed via the coset partitioning. Section VII provides simulation results and shows that the new codes outperform the best known corresponding codes.

II. SPACE-TIME TRELLIS CODES

We consider a 2^n -PSK space-time trellis encoder with n_T transmit antennas and n_R receive antennas. For $n = 2$, the encoder is shown in Fig. 1.

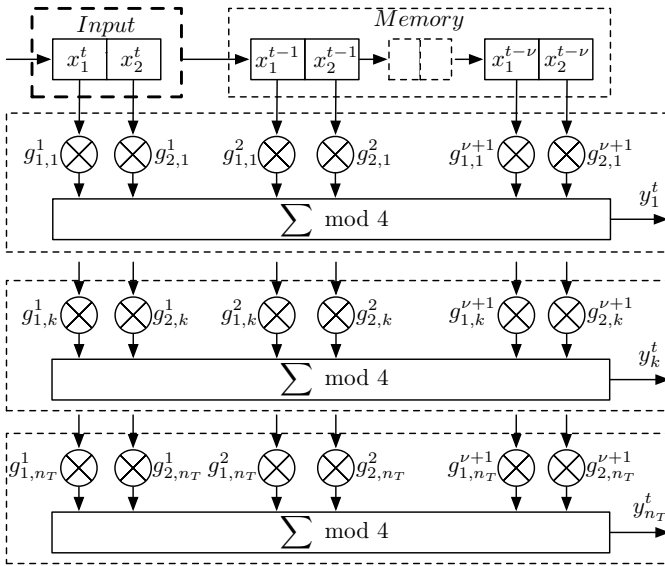

Fig. 1. Space-time trellis encoder for 4-PSK and n_T transmit antennas.

In the general case, the encoder is composed of one input block of n bits and ν memory blocks of n bits. At each time $t \in \mathbb{Z}$, all the bits of a block are replaced by the n bits of the previous block. For each block $i = \overline{1, \nu + 1}$ i.e. i takes all values $: 1, 2, \dots, \nu + 1$, the j^{th} bit is associated to n_T coefficients $g_{j,k}^i \in \mathbb{Z}_{2^n}$, with $j = \overline{1, n}$ and $k = \overline{1, n_T}$.

With these $n_T \times n(\nu + 1)$ coefficients, the generator matrix \mathbf{G} with n_T lines and $\nu + 1$ blocks of n columns is given by

$$\begin{aligned} \mathbf{G} &= [\mathbf{G}^1 | \mathbf{G}^2 | \dots | \mathbf{G}^{\nu+1}] \\ &= [G_1^1 \dots G_n^1 | G_1^2 \dots G_n^2 | \dots | G_1^{\nu+1} \dots G_n^{\nu+1}], \end{aligned} \quad (1)$$

where $\mathbf{G}^i = [G_1^i \dots G_n^i]$ is the i^{th} block of \mathbf{G} and $G_j^i = [g_{j,1}^i \dots g_{j,n_T}^i]^T \in \mathbb{Z}_{2^n}^{n_T}$ (i.e. each column is a MIMO symbol)¹. The set $\mathbb{Z}_{2^n}^{n_T}$ is the set of column vectors constituted by n_T elements that belong to the set of integers modulo 2^n . In this paper, $[\cdot]^T$ is the transpose of the matrix $[\cdot]$.

A state is defined by the binary values of the $n\nu$ memory cells corresponding to the no-null columns of \mathbf{G} . The coefficients of a no-null column are not all null. At each time t , the MIMO symbols $Y^t = [y_1^t y_2^t \dots y_{n_T}^t]^T \in \mathbb{Z}_{2^n}^{n_T}$ at the encoder output are given by the function Ψ defined by

$$\Psi : \mathbb{Z}_2^{n(\nu+1)} \rightarrow \mathbb{Z}_{2^n}^{n_T} \quad (3)$$

$$Y^t = \Psi(X^t) = \mathbf{G}X^t, \quad (4)$$

where $X^t = [x_1^t \dots x_n^t \dots x_1^{t-\nu} \dots x_n^{t-\nu}]^T$ is the extended-state at time t of the $L_r = n(\nu + 1)$ length shift register realized by the input block and the ν memory blocks.

An encoder can also be represented by a trellis, as shown in Fig. 2 for a 4-state 4-PSK STTC corresponding to the generator matrix

$$\mathbf{G} = [Y_1 Y_2 | Y_4 Y_8]. \quad (5)$$

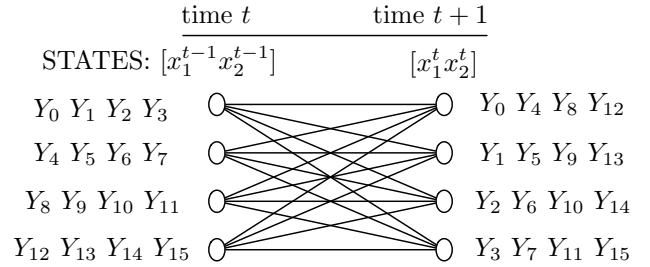

Fig. 2. 4-state 4-PSK STTC.

In the trellis, the states are described by the points and the transitions between the states by the lines. Each transition corresponds to an extended-state. The vector $Y_i \in \mathbb{Z}_4^{n_T}$ represents the MIMO symbol associated to an extended-state. The index i is computed as the decimal value of the extended-state with x_1^t the least significant bit.

In the general case, for a 2^n -PSK STTC, there are 2^n transitions originating from each state or merging into each state. Each MIMO symbol Y^t belongs to $\mathbb{Z}_{2^n}^{n_T}$.

Each MIMO symbol Y^t is mapped onto a 2^n -PSK MIMO signal $S^t = \Phi(Y^t)$ given by the mapping

¹The matrix \mathbf{G} is the transpose of the generator matrix given in [20]. In this manner, \mathbf{G} is directly given by the representation of the encoder given in Fig. 1.

function

$$\Phi : \mathbb{Z}_{2^n}^{n_T} \rightarrow \mathbb{C}^{n_T} \quad (6)$$

$$\Phi(Y^t) = \begin{bmatrix} \exp(j\frac{\pi}{2^{n-1}}y_1^t) \\ \vdots \\ \exp(j\frac{\pi}{2^{n-1}}y_k^t) \\ \vdots \\ \exp(j\frac{\pi}{2^{n-1}}y_{n_T}^t) \end{bmatrix}, \quad (7)$$

where $j^2 = -1$. Each output signal s_k^t is sent to the k^{th} transmit antenna. At each time t , the symbols transmitted simultaneously over the fading MIMO channel are given by $S^t = [s_1^t \cdots s_{n_T}^t]^T$. The vector of the signals received by the n_R receive antennas $R^t = [r_1^t \cdots r_{n_R}^t]^T$ can be written as

$$R^t = \mathbf{H}^t S^t + N^t, \quad (8)$$

where $N^t = [n_1^t \cdots n_{n_R}^t]^T$ is the vector of complex additive white gaussian noises (AWGN) at time t . The $n_R \times n_T$ matrix \mathbf{H}^t representing the complex path gains of the MIMO channel between the transmit and receive antennas at time t is given by

$$\mathbf{H}^t = \begin{bmatrix} h_{1,1}^t & \cdots & h_{1,n_T}^t \\ \vdots & \ddots & \vdots \\ h_{n_R,1}^t & \cdots & h_{n_R,n_T}^t \end{bmatrix}. \quad (9)$$

In this paper, Rayleigh fading channels are considered. In that case, the path gain $h_{i,k}^t$ of the SISO channel between the k^{th} transmit antenna and i^{th} receive antenna follows a Rayleigh distribution, i.e. the real and the imaginary parts of $h_{i,k}^t$ are zero-mean Gaussian random variables with the same variance. Two types of Rayleigh fading channels can be considered:

- Slow Rayleigh fading channels: the complex path gains of the channels do not change during the transmission of the symbols of the same codeword.
- Fast Rayleigh fading channels: the complex path gains of the channels change independently at each time t .

III. DESIGN CRITERIA

The main goal of this design is to reduce the pairwise error probability (PEP) which is the probability that the decoder selects an erroneous codeword \mathbf{E} while a different codeword \mathbf{S} was transmitted. It is possible to represent a codeword of L MIMO signals starting at $t = 1$ by a $n_T \times L$ matrix $\mathbf{S} = [S^1 S^2 \dots S^L]$ where $S^t \in \mathbb{C}^{n_T}$ is the t^{th} MIMO signal of the codeword \mathbf{S} . An error occurs if the decoder decides that another codeword $\mathbf{E} = [E^1 E^2 \dots E^L]$ is transmitted where $E^t \in \mathbb{C}^{n_T}$ is the

t^{th} MIMO signal of the codeword \mathbf{E} . Let us define the $n_T \times L$ difference matrix

$$\mathbf{B} = \mathbf{E} - \mathbf{S} = \begin{bmatrix} e_1^1 - s_1^1 & \cdots & e_1^L - s_1^L \\ \vdots & \ddots & \vdots \\ e_{n_T}^1 - s_{n_T}^1 & \cdots & e_{n_T}^L - s_{n_T}^L \end{bmatrix}. \quad (10)$$

The $n_T \times n_T$ product matrix $\mathbf{A} = \mathbf{B}\mathbf{B}^H$ is introduced, where \mathbf{B}^H denotes the hermitian of \mathbf{B} . The minimum rank of \mathbf{A} , $r = \min\{\text{rank}(\mathbf{A})\}$ is defined, where \mathbf{A} is computed for all pairs of codewords (\mathbf{E}, \mathbf{S}) . The design criteria depend on the value of the product rn_R .

First case: $rn_R \leq 3$:

In this case, for a slow Rayleigh fading channel, two criteria have been proposed [5], [12] to reduce the PEP, as follows:

- \mathbf{A} has to be a full rank matrix for any pair (\mathbf{E}, \mathbf{S}) . Since the maximal value of r is n_T , the achievable spatial diversity order is $n_T n_R$.
- The coding gain is related to the inverse of $\eta = \sum_d N(d) d^{-n_R}$, where $N(d)$ is defined as the average number of error events (\mathbf{E}, \mathbf{S}) with the determinant of \mathbf{A} equal to

$$\begin{aligned} d &= \det(\mathbf{A}) = \prod_{k=1}^{n_T} \lambda_k \\ &= \prod_{k=1}^{n_T} \left(\sum_{t=1}^L |e_k^t - s_k^t|^2 \right). \end{aligned} \quad (11)$$

The codes with the best performance must have the minimum value of η .

In the case of a fast Rayleigh fading channel, different criteria have been obtained in [5]. Tarokh *et al.* defined the Hamming distance $d_H(\mathbf{E}, \mathbf{S})$ between two codewords \mathbf{E} and \mathbf{S} as the number of time intervals for which $|E^t - S^t| \neq 0$. For a given code, $d_H(\mathbf{E}, \mathbf{S})$ is computed for each pair (\mathbf{E}, \mathbf{S}) with $\mathbf{E} \neq \mathbf{S}$. Each code has one value $\min\{d_H(\mathbf{E}, \mathbf{S})\}$. The best codes must have the largest minimal value of $d_H(\mathbf{E}, \mathbf{S})$.

In this case, the achieved spatial diversity order is equal to $\min\{d_H(\mathbf{E}, \mathbf{S})\}n_R$. In the same way, Tarokh *et al.* introduced the product distance $d_p^2(\mathbf{E}, \mathbf{S})$ which is the product of squared Euclidean distances of two MIMO signals at each time t of two different codewords. Thus, $d_p^2(\mathbf{E}, \mathbf{S})$ is given by

$$d_p^2(\mathbf{E}, \mathbf{S}) = \prod_{\substack{t=1 \\ E^t \neq S^t}}^L d_E^2(E^t, S^t), \quad (12)$$

where $d_E^2(E^t, S^t) = \sum_{k=1}^{n_T} |e_k^t - s_k^t|^2$ is the ED between the MIMO signals E^t and S^t at time t . For a given code,

$d_p^2(\mathbf{E}, \mathbf{S})$ is computed for each pair (\mathbf{E}, \mathbf{S}) with $\mathbf{E} \neq \mathbf{S}$. Each code has one value $\min \{d_p^2(\mathbf{E}, \mathbf{S})\}$. The best codes must have the largest minimal value of $d_p^2(\mathbf{E}, \mathbf{S})$.

Second case: $rn_R \geq 4$:

In [6] and [7], it is shown that for a large value of rn_R which corresponds to a large number of independent SISO channels, the PEP is minimized if the sum of all the eigenvalues of the matrices \mathbf{A} is maximized. Since \mathbf{A} is a square matrix, the sum of all the eigenvalues is equal to its trace

$$\text{tr}(\mathbf{A}) = \sum_{k=1}^{n_T} \lambda_k = \sum_{t=1}^L d_E^2(E^t, S^t). \quad (13)$$

For a given code, $\text{tr}(\mathbf{A})$ is computed for each pair (\mathbf{E}, \mathbf{S}) with $\mathbf{E} \neq \mathbf{S}$. Each code has one value $\min\{\text{tr}(\mathbf{A})\}$. The best codes must have the largest minimal value of $\text{tr}(\mathbf{A})$. The concept of ED for STTCs has been previously introduced in [8] and [9]. In [12], it is also stated that to minimize the frame error rate (FER), the number of error events with minimum ED between codewords has to be minimized. Besides, it has been shown in [9] that the maximization of the ED between two codewords is equivalent to the maximization of the product distance.

In this paper, we consider only the case $rn_R \geq 4$ which is obtained when $r \geq 2$ and there are at least 2 receive antennas.

IV. COSET PARTITIONING

The main goal of coset partitioning is to generate quickly and easily STTCs which achieve the best performance. If an exhaustive search is used to find the best $2^{n\nu}$ -state 2^n -PSK STTCs with n_T transmit antennas, the previous criteria are tested for $2^{n_T n^2 (\nu+1)}$ possible generator matrices \mathbf{G} . The exhaustive search requires a huge computing time, especially when n_T , n and ν increase. The coset partitioning generates a small set of codes containing the optimal codes. So, the time to find the best codes is drastically reduced.

A. Preliminary

Each MIMO symbol belongs to the additive abelian group $\mathbb{Z}_{2^n}^{n_T}$. Let us assume the subgroup

$$\mathcal{C}_0 = 2^{n-1} \mathbb{Z}_2^{n_T} \quad (14)$$

of $\mathbb{Z}_{2^n}^{n_T}$ such as $V = -V, \forall V \in \mathcal{C}_0$. As presented later, the choice of this specific subgroup \mathcal{C}_0 is useful to create subgroups of $\mathbb{Z}_{2^n}^{n_T}$.

It is possible to partition the group $\mathbb{Z}_{2^n}^{n_T}$ into $2^{n_T(n-1)}$ cosets as

$$\mathbb{Z}_{2^n}^{n_T} = \bigcup_{P \in \mathbb{Z}_{2^{n-1}}^{n_T}} \mathcal{C}_P, \quad (15)$$

where P is a representative of the coset $\mathcal{C}_P = P + \mathcal{C}_0$, as stated in [21].

Using these cosets, it is possible to make a new partition of $\mathbb{Z}_{2^n}^{n_T}$ given by

$$\mathbb{Z}_{2^n}^{n_T} = \bigcup_{k=0}^{n-1} \mathcal{E}_k, \quad (16)$$

where $\mathcal{E}_0 = \mathcal{C}_0$. For $k = \overline{1, n-1}$, the other sets \mathcal{E}_k are defined by

$$\mathcal{E}_k = \bigcup_{P_k} (P_k + \mathcal{C}_0) = \bigcup_{P_k} \mathcal{C}_{P_k}, \quad (17)$$

where $P_k \in 2^{n-k-1} \mathbb{Z}_{2^k}^{n_T} \setminus 2^{n-k} \mathbb{Z}_{2^{k-1}}^{n_T}$. The difference of two sets is $\mathcal{A} \setminus \mathcal{B} = \{x \in \mathcal{A} \text{ and } x \notin \mathcal{B}\}$. The set $\mathbb{Z}_1^{n_T}$ contains only the null element of $\mathbb{Z}_{2^n}^{n_T}$.

Definition 1: We consider a subgroup Λ_s of $\mathbb{Z}_{2^n}^{n_T}$ such as $\text{card}(\Lambda_s) \leq 2^{n_T n - 1}$. A coset $\mathcal{C}_P = P + \Lambda_s$ with $P \in \mathbb{Z}_{2^n}^{n_T}$ is called *relative to* $Q \in \Lambda_s$ if and only if $2P = Q$. Thus, if we consider the subgroup \mathcal{C}_0 and the partition into n sets of elements formed by unions of cosets, for $k = \overline{2, n-1}$, each coset $\mathcal{C}_{P_k} \subset \mathcal{E}_k$ is *'relative to'* $Q = 2P_k \in \mathcal{E}_{k-1}$.

For example, for 8-PSK STTCs with 2 transmit antennas, the MIMO symbols belong to \mathbb{Z}_8^2 . This group is divided into 3 subsets. In this case, the first set is

$$\mathcal{E}_0 = \mathcal{C}_0 = \left\{ \begin{bmatrix} 0 \\ 0 \end{bmatrix}, \begin{bmatrix} 0 \\ 4 \end{bmatrix}, \begin{bmatrix} 4 \\ 0 \end{bmatrix}, \begin{bmatrix} 4 \\ 4 \end{bmatrix} \right\}. \quad (18)$$

The second set is

$$\mathcal{E}_1 = \mathcal{C}_{\begin{bmatrix} 0 \\ 2 \end{bmatrix}} \cup \mathcal{C}_{\begin{bmatrix} 2 \\ 0 \end{bmatrix}} \cup \mathcal{C}_{\begin{bmatrix} 2 \\ 2 \end{bmatrix}}, \quad (19)$$

where

- $\mathcal{C}_{\begin{bmatrix} 0 \\ 2 \end{bmatrix}} = \left\{ \begin{bmatrix} 0 \\ 2 \end{bmatrix}, \begin{bmatrix} 0 \\ 6 \end{bmatrix}, \begin{bmatrix} 2 \\ 2 \end{bmatrix}, \begin{bmatrix} 2 \\ 6 \end{bmatrix} \right\}$ is relative to $\begin{bmatrix} 0 \\ 4 \end{bmatrix} \in \mathcal{C}_0$.
- $\mathcal{C}_{\begin{bmatrix} 2 \\ 0 \end{bmatrix}} = \left\{ \begin{bmatrix} 2 \\ 0 \end{bmatrix}, \begin{bmatrix} 2 \\ 4 \end{bmatrix}, \begin{bmatrix} 6 \\ 0 \end{bmatrix}, \begin{bmatrix} 6 \\ 4 \end{bmatrix} \right\}$ is relative to $\begin{bmatrix} 4 \\ 0 \end{bmatrix} \in \mathcal{C}_0$.
- $\mathcal{C}_{\begin{bmatrix} 2 \\ 2 \end{bmatrix}} = \left\{ \begin{bmatrix} 2 \\ 2 \end{bmatrix}, \begin{bmatrix} 2 \\ 6 \end{bmatrix}, \begin{bmatrix} 6 \\ 2 \end{bmatrix}, \begin{bmatrix} 6 \\ 6 \end{bmatrix} \right\}$ is relative to $\begin{bmatrix} 4 \\ 4 \end{bmatrix} \in \mathcal{C}_0$.

The last set is

$$\begin{aligned} \mathcal{E}_2 = & \mathcal{C}_{\begin{bmatrix} 0 \\ 1 \end{bmatrix}} \cup \mathcal{C}_{\begin{bmatrix} 0 \\ 3 \end{bmatrix}} \cup \mathcal{C}_{\begin{bmatrix} 1 \\ 1 \end{bmatrix}} \cup \mathcal{C}_{\begin{bmatrix} 1 \\ 3 \end{bmatrix}} \cup \\ & \mathcal{C}_{\begin{bmatrix} 1 \\ 0 \end{bmatrix}} \cup \mathcal{C}_{\begin{bmatrix} 1 \\ 2 \end{bmatrix}} \cup \mathcal{C}_{\begin{bmatrix} 3 \\ 0 \end{bmatrix}} \cup \mathcal{C}_{\begin{bmatrix} 3 \\ 2 \end{bmatrix}} \cup \\ & \mathcal{C}_{\begin{bmatrix} 1 \\ 1 \end{bmatrix}} \cup \mathcal{C}_{\begin{bmatrix} 1 \\ 3 \end{bmatrix}} \cup \mathcal{C}_{\begin{bmatrix} 3 \\ 1 \end{bmatrix}} \cup \mathcal{C}_{\begin{bmatrix} 3 \\ 3 \end{bmatrix}}, \end{aligned} \quad (20)$$

where

$$\begin{aligned} \mathcal{C}_{\begin{bmatrix} 0 \\ 1 \end{bmatrix}} &= \left\{ \begin{bmatrix} 0 \\ 1 \end{bmatrix}, \begin{bmatrix} 0 \\ 5 \end{bmatrix}, \begin{bmatrix} 1 \\ 1 \end{bmatrix}, \begin{bmatrix} 1 \\ 5 \end{bmatrix} \right\} \\ \mathcal{C}_{\begin{bmatrix} 0 \\ 3 \end{bmatrix}} &= \left\{ \begin{bmatrix} 0 \\ 3 \end{bmatrix}, \begin{bmatrix} 0 \\ 7 \end{bmatrix}, \begin{bmatrix} 1 \\ 3 \end{bmatrix}, \begin{bmatrix} 1 \\ 7 \end{bmatrix} \right\} \\ \mathcal{C}_{\begin{bmatrix} 1 \\ 1 \end{bmatrix}} &= \left\{ \begin{bmatrix} 1 \\ 1 \end{bmatrix}, \begin{bmatrix} 1 \\ 5 \end{bmatrix}, \begin{bmatrix} 3 \\ 1 \end{bmatrix}, \begin{bmatrix} 3 \\ 5 \end{bmatrix} \right\} \\ \mathcal{C}_{\begin{bmatrix} 1 \\ 3 \end{bmatrix}} &= \left\{ \begin{bmatrix} 1 \\ 3 \end{bmatrix}, \begin{bmatrix} 1 \\ 7 \end{bmatrix}, \begin{bmatrix} 3 \\ 3 \end{bmatrix}, \begin{bmatrix} 3 \\ 7 \end{bmatrix} \right\}. \end{aligned}$$

These cosets are relative to the symbols $[\frac{0}{2}]$, $[\frac{0}{6}]$, $[\frac{4}{2}]$ and $[\frac{4}{6}]$ respectively which form $\mathcal{C}_{[\frac{0}{2}]}$.

$$\mathcal{C}_{[\frac{1}{0}]} = \{[\frac{1}{0}], [\frac{1}{4}], [\frac{5}{0}], [\frac{5}{4}]\}$$

$$\mathcal{C}_{[\frac{1}{2}]} = \{[\frac{1}{2}], [\frac{1}{6}], [\frac{5}{2}], [\frac{5}{6}]\}$$

$$\mathcal{C}_{[\frac{3}{0}]} = \{[\frac{3}{0}], [\frac{3}{4}], [\frac{7}{0}], [\frac{7}{4}]\}$$

$$\mathcal{C}_{[\frac{3}{2}]} = \{[\frac{3}{2}], [\frac{3}{6}], [\frac{7}{2}], [\frac{7}{6}]\}$$

These cosets are relative to the symbols $[\frac{2}{0}]$, $[\frac{2}{4}]$, $[\frac{6}{0}]$ and $[\frac{6}{4}]$ respectively which form the coset $\mathcal{C}_{[\frac{2}{0}]}$.

$$\mathcal{C}_{[\frac{1}{1}]} = \{[\frac{1}{1}], [\frac{1}{5}], [\frac{5}{1}], [\frac{5}{5}]\}$$

$$\mathcal{C}_{[\frac{1}{3}]} = \{[\frac{1}{3}], [\frac{1}{7}], [\frac{5}{3}], [\frac{5}{7}]\}$$

$$\mathcal{C}_{[\frac{3}{1}]} = \{[\frac{3}{1}], [\frac{3}{5}], [\frac{7}{1}], [\frac{7}{5}]\}$$

$$\mathcal{C}_{[\frac{3}{3}]} = \{[\frac{3}{3}], [\frac{3}{7}], [\frac{7}{3}], [\frac{7}{7}]\}$$

These cosets are relative to the symbols $[\frac{2}{2}]$, $[\frac{2}{6}]$, $[\frac{6}{2}]$ and $[\frac{6}{6}]$ respectively which form the coset $\mathcal{C}_{[\frac{2}{2}]}$.

The following propositions are used to create subgroups of $\mathbb{Z}_{2^n}^{n_T}$.

Proposition 1: If Λ_l is a subgroup of $\mathbb{Z}_{2^n}^{n_T}$ given by

$$\Lambda_l = \left\{ \sum_{m=1}^l x_m V_m \bmod 2^n / x_m \in \{0, 1\} \right\}, \quad (21)$$

with $V_m \in \mathbb{Z}_{2^n}^{n_T}$, $l = \overline{1, nn_T}$ where nn_T is the minimal number of vectors which generate the group $\mathbb{Z}_{2^n}^{n_T}$ and $\text{card}(\Lambda_l) = 2^l$, then there is at least one element V_m which belongs to $\mathcal{C}_0^* = \mathcal{C}_0 \setminus [0 \cdots 0]^T$.

Proof: See Appendix A ■

Proposition 2: To generate a subgroup $\Lambda_l = \left\{ \sum_{m=1}^l x_m V_m \bmod 2^n / x_m \in \{0, 1\} \right\}$ with $V_m \in \mathbb{Z}_{2^n}^{n_T}$, $l = \overline{1, nn_T}$ and $\text{card}(\Lambda_l) = 2^l$, the V_m elements must be selected as follows:

- The first element V_1 must belong to \mathcal{C}_0^* .
- If $m - 1$ elements with $m \in \{2, \dots, l\}$ have been previous selected, the m^{th} column V_m must not belong to $\Lambda_{m-1} = \left\{ \sum_{m'=1}^{m-1} x_{m'} V_{m'} \bmod 2^n / x_{m'} \in \{0, 1\} \right\}$ and must belong to \mathcal{C}_0^* or to the cosets relative to an element of Λ_{m-1} .

Proof: See Appendix B ■

B. Euclidian distances decomposition

In the next sections, the ED between two codewords is notified by 'Cumulated ED' (CED), in opposition with the ED between two MIMO signals. Thus, if two codewords $\mathbf{E} = [E^1 E^2 \dots E^L]$ and $\mathbf{S} = [S^1 S^2 \dots S^L]$ of L MIMO symbols are considered, the CED between \mathbf{E} et \mathbf{S} is

$$\sum_{t=1}^L d_E^2(E^t, S^t). \quad (22)$$

For a 2^n -PSK $2^{n\nu}$ -state STTC with n_T transmit antennas, two different input binary sequences of $n(L - \nu)$ bits, as shown in Fig. 1, are considered:

- $X_e = [x_{e,1}^1 \cdots x_{e,n}^1 | x_{e,1}^2 \cdots x_{e,n}^2 | \cdots | x_{e,1}^{L-\nu} \cdots x_{e,n}^{L-\nu}]$
- $X_s = [x_{s,1}^1 \cdots x_{s,n}^1 | x_{s,1}^2 \cdots x_{s,n}^2 | \cdots | x_{s,1}^{L-\nu} \cdots x_{s,n}^{L-\nu}]$

These two sequences generate two codewords \mathbf{E} and \mathbf{S} of length L . These sequences correspond to two different paths in the trellis.

The initial extended-states of the encoder are equal to

$$X_e^0 = X_s^0 = [0 \cdots 0 | \cdots | 0 \cdots 0]. \quad (23)$$

At each time $t = \overline{1, L}$, the two binary sequences $x_{e,1}^t \cdots x_{e,n}^t$ and $x_{s,1}^t \cdots x_{s,n}^t$ are fed into the input encoder. Thus, the extended-states at time $t = 1$ are

$$X_e^1 = [x_{e,1}^1 \cdots x_{e,n}^1 | 0 \cdots 0 | \dots | 0 \cdots 0] \quad (24)$$

$$X_s^1 = [x_{s,1}^1 \cdots x_{s,n}^1 | 0 \cdots 0 | \dots | 0 \cdots 0]. \quad (25)$$

The extended-states at time $t = 2$ are

$$X_e^2 = [x_{e,1}^2 \cdots x_{e,n}^2 | x_{e,1}^1 \cdots x_{e,n}^1 | \dots | 0 \cdots 0] \quad (26)$$

$$X_s^2 = [x_{s,1}^2 \cdots x_{s,n}^2 | x_{s,1}^1 \cdots x_{s,n}^1 | \dots | 0 \cdots 0]. \quad (27)$$

At each time t , the values of the extended-states are $X_e^t = [x_{e,1}^t \cdots x_{e,n}^t | \cdots | x_{e,1}^{t-\nu} \cdots x_{e,n}^{t-\nu}]^T$ and $X_s^t = [x_{s,1}^t \cdots x_{s,n}^t | \cdots | x_{s,1}^{t-\nu} \cdots x_{s,n}^{t-\nu}]^T$.

Because the final extended-states of the encoder must be equal to $X_e^{L+1} = X_s^{L+1} = [0 \cdots 0 | \cdots | 0 \cdots 0]$, the last extended-states are

$$X_e^L = [0 \cdots 0 | \dots | 0 \cdots 0 | x_{e,1}^{L-\nu} \cdots x_{e,n}^{L-\nu}] \quad (28)$$

$$X_s^L = [0 \cdots 0 | \dots | 0 \cdots 0 | x_{s,1}^{L-\nu} \cdots x_{s,n}^{L-\nu}]. \quad (29)$$

At each time t , two MIMO signals

$$E^t = [e_1^t \cdots e_{n_T}^t]^T = \Phi(\mathbf{G} X_e^t) \quad (30)$$

and

$$S^t = [s_1^t \cdots s_{n_T}^t]^T = \Phi(\mathbf{G} X_s^t) \quad (31)$$

are generated.

The ED between two MIMO signals at time t is given by $d_E^2(E^t, S^t) = \sum_{k=1}^{n_T} |e_k^t - s_k^t|^2$. It is possible

to compute this ED thanks to the two corresponding extended-states X_e^t and X_s^t and the generator matrix \mathbf{G} via the function D_E defined as

$$D_E : \mathbb{Z}_{2^n}^{n(\nu+1)} \times \mathbb{Z}_{2^n}^{n(\nu+1)} \rightarrow \mathbb{R}^+ \\ D_E(X_e^t, X_s^t) = d_E^2(\Phi(\mathbf{G}X_e^t), \Phi(\mathbf{G}X_s^t)). \quad (32)$$

Thus, each CED is given by

$$CED(X_e, X_s) = \sum_{t=1}^L D_E(X_e^t, X_s^t). \quad (33)$$

It is easy to show that for $m \leq \nu + 1$ the m^{th} and the $(L - m + 1)^{\text{th}}$ last term of CEDs depend of the m first blocks and the m last blocks of \mathbf{G} respectively.

Let us consider the case of $2^{n\nu}$ -state 2^n -PSK STTCs. We define

$$\alpha_M = \lfloor \frac{\nu + 1}{2} \rfloor. \quad (34)$$

To ensure that the CEDs of STTCs are maximized, the minimum result of the sum of the first $\alpha = \overline{1, \alpha_M}$ terms of the CED

$$\sum_{t=1}^{\alpha} D_E(X_e^t, X_s^t) \quad (35)$$

must be maximized for all pairs (X_e, X_s) via the selection of the first α_M blocks.

In the same way and independently of the sum of the first $\alpha = \overline{1, \alpha_M}$ terms, the minimum result of the sum of the last α_M terms of the CED

$$\sum_{t=L-\alpha+1}^L D_E(X_e^t, X_s^t) \quad (36)$$

must be maximized for all pairs (X_e, X_s) via the selection of the last α_M blocks. If ν is even, the $(\alpha_M + 1)^{\text{th}}$ term must be selected to generate a subgroup and to maximize the CED.

The set of the first α_M blocks is denoted

$$\mathcal{B}_F = \{ \mathbf{G}^1, \dots, \mathbf{G}^{\alpha_M} \} \quad (37)$$

$$= \{ [G_1^1 \dots G_n^1], \dots, [G_1^{\alpha_M} \dots G_n^{\alpha_M}] \} \quad (38)$$

and the set of the last α_M blocks is denoted

$$\mathcal{B}_L = \{ \mathbf{G}^{\nu+2-\alpha_M}, \mathbf{G}^{\nu+3-\alpha_M}, \dots, \mathbf{G}^{\nu+1} \} \quad (39)$$

$$= \{ [G_1^{\nu+2-\alpha_M} \dots G_n^{\nu+2-\alpha_M}], \\ [G_1^{\nu+3-\alpha_M} \dots G_n^{\nu+3-\alpha_M}], \\ [G_1^{\nu+1} \dots G_n^{\nu+1}] \}. \quad (40)$$

No block of \mathbf{G} belongs to both \mathcal{B}_F and \mathcal{B}_L i.e.

$$\mathcal{B}_F \cap \mathcal{B}_L = \emptyset. \quad (41)$$

Thus, the first α_M blocks and the last α_M blocks of the CED are totally independent.

If ν is even, the $(\alpha_M + 1)^{\text{th}}$ first block creates the dependance between the first α_M terms and the last α_M terms in order to maximize the minimal value of the CED computed for all pairs of different codewords (\mathbf{E}, \mathbf{S}) .

C. Coset partitioning description

In [1], [2], [3], Ungerboeck proposed the set partitioning to design TCMs for SISO systems. The set partitioning can be stated by the following rules:

Rule 1: Each point of the constellation has the same number of occurrences.

Rule 2: In the trellis, transitions originating from a same state or merging into a same state should be assigned subsets which contain signal points separated by the largest EDs.

Rule 3: Parallel paths should be assigned signal points separated by the largest EDs.

Calderbank *et al.* gave an alternative to the set partitioning but only for SISO systems [4]: the constellation must be a subgroup of an abelian group which is divided into cosets. At each time t , the encoder selects one coset, then one element within the selected coset.

The coset partitioning proposed in this paper is an extension to MIMO systems of the set partitioning using the Calderbank's approach. In the case of coset partitioning, the MIMO symbols are separated into **cosets** (not just into sets, as in the case of the set partitioning) which contain MIMO symbols separated by the largest EDs. Thus, the number of possibilities to design optimal STTCs is reduced, compared to the number of set partitioning possibilities.

The coset partitioning can be stated by the following properties:

Property 1: the used MIMO symbols are equally probable.

Property 2: the MIMO symbols originating from or merging to a same state belong to the same coset.

Property 3: the elements of each coset must be separated by the largest EDs.

For a $2^{n\nu}$ -state 2^n -PSK STTC, the generator matrix has $\nu + 1$ blocks of n_T lines and n columns. In order that a STTC fulfils the 3 properties of the coset partitioning, the n columns of each block $\mathbf{G}^i = [G_1^i \dots G_n^i]$ with $i = \overline{1, \nu + 1}$ of its generator matrix \mathbf{G} must generate a subgroup

$$\Lambda_i = \left\{ \sum_{j=1}^n x_j G_j^i \bmod 2^n / x_j \in \{0, 1\} \right\} \quad (42)$$

of $\mathbb{Z}_{2^n}^{n_T}$, with $\text{card}(\Lambda_i) = 2^n$.

In order to obtain a subgroup, the selection of the n columns of each block must respect the proposition 2, i.e. the n columns of each block i with $i = \overline{1, \nu+1}$, must be selected as follows:

- The first column G_1^i must belong to \mathcal{C}_0^* .
- If $j - 1$ columns have been previously selected with $j \in \{2, \dots, n\}$, the column G_j^i must not belong to the subgroup $\Lambda_{j-1} = \left\{ \sum_{l=1}^{j-1} x_l^i G_l^i \bmod 2^n / x_l^i \in \{0, 1\} \right\}$ and must belong to \mathcal{C}_0^* or to a coset relative to an element of Λ_{j-1} .

Thus, the columns of each block generate a subgroup and the elements originating from or merging to the same state belong to the same coset.

Besides, to ensure that the CED is maximized, the minimum result of the sum of first $\alpha = \overline{1, \alpha_M}$ terms

$$\sum_{t=1}^{\alpha} D_E(X_e^t, X_s^t) \quad (43)$$

must be maximized for all pairs of different binary sequences (X_e, X_s) . In order to maximize the previous expression, we define the optimal blocks.

Definition 2: An optimal block generates a subgroup of $\mathbb{Z}_{2^n}^{n_T}$ containing the MIMO symbols separated by the largest minimal ED.

Therefore, the first α_M blocks must be selected as follows:

- The first block used to compute the first term $D_E(X_e^1, X_s^1)$ must be an optimal block. Thereby, the property 3 of the coset partitioning is fulfilled.
- If the first $i - 1$ blocks have been already selected with $i \in \{2, \dots, \alpha_M\}$, the i^{th} block must be selected to maximize the minimum value of $\sum_{t=1}^i D_E(X_e^t, X_s^t)$ computed for all pairs of different binary sequences (X_e, X_s) .

In the same way, the minimum result of the sum of the last $\alpha = \overline{1, \alpha_M}$ terms

$$\sum_{t=L-\alpha+1}^L D_E(X_e^t, X_s^t) \quad (44)$$

must be maximized for all pairs (X_e, X_s) with $X_e \neq X_s$. Therefore, the last α_M blocks must be selected as follows:

- The last block used to compute the last term $D_E(X_e^L, X_s^L)$ must be an optimal block.
- If the last $i - 1$ blocks have been already selected with $i \in \{2, \dots, \alpha_M\}$, the last i^{th} block must be selected to maximize the minimum value of

$\sum_{t=L-i+1}^L D_E(X_e^t, X_s^t)$ computed for all pairs of different binary sequences (X_e, X_s) .

Further on, if ν is even, the $(\alpha_M + 1)^{\text{th}}$ block \mathbf{G}^{α_M+1} must generate a subgroup and maximize the CED.

Besides, the property 1 of the coset partitioning is fulfilled because these STTCs designed via the coset partitioning are balanced codes [22], [23].

Definition 3: A STTC is balanced if and only if the generated MIMO symbols Y have the same number of occurrences $n(Y) = \text{card} \left\{ X \in \mathbb{Z}_2^{n(\nu+1)} / Y = \mathbf{G}X \right\}$, $\forall Y \in \Psi(\mathbb{Z}_2^{n(\nu+1)})$. In this case, if the input data are sent by a binary memoryless source with equally probable symbols, the generated MIMO symbols are also equally probable.

If the columns of \mathbf{G} generate a subgroup of $\mathbb{Z}_{2^n}^{n_T}$, then the STTC is balanced [23]. For a STTC designed with the coset partitioning, the set Λ of generated MIMO symbols is a subgroup of $\mathbb{Z}_{2^n}^{n_T}$ given by

$$\Lambda = \sum_{i=1}^{\nu+1} \Lambda_i, \quad (45)$$

where Λ_i is the subgroup generated by the n columns of the block i of \mathbf{G} . Thus, for these codes, the first rule of set partitioning is fulfilled.

Remark: The STTCs designed with the coset partitioning respect also the rules of the set partitioning, excepting the third rule, because there are no parallel paths in the case of STTCs. The main advantage of the coset partitioning compared to the set partitioning is the reduced number of possible codes. In fact, the selection of cosets is more restrictive than the selection of sets.

Multidimensional space-time trellis codes (MSTTCs) have been proposed by Jafarkhani *et al.* in [24] named super-orthogonal space-time trellis codes (SO-STTCs) and by Ionescu in [9]. Similarly to the proposed method, Ionescu divides the multidimensional space-time constellation into cosets. In this manner, as proved in [25], the created codes are geometrically uniform codes. A code is geometrically uniform if the sets of CEDs computed between any codeword and all other codewords are all the same. One of the advantages of geometrically uniform codes is the efficiency to compute the minimal CED between each pair of different codewords. In order to create a STTC via the coset partitioning which is geometrically uniform, it is sufficient that all the blocks of \mathbf{G} have the same structure. The blocks $\mathbf{G}^i = [G_1^i \dots G_n^i]$ with $i = \overline{1, \nu+1}$ have the same structure if and only if $G_j^1, G_j^2, \dots, G_j^{\nu+1} \in \mathcal{E}_l$ with $j = \overline{1, n}$ and $l \in \{0, \dots, n-1\}$.

D. Design examples for 2^n -state ($\nu = 1$) 2^n -PSK STTCs

The MIMO symbols belong to $\mathbb{Z}_{2^n}^{n_T}$. The generator matrix \mathbf{G} has 2 blocks of n columns: $\mathbf{G}i = [G_1^i, \dots, G_n^i]$, with $i = \overline{1, 2}$.

To create the best 2^n -PSK codes, the generator matrix is divided into 2 sets of blocks \mathcal{B}_F and \mathcal{B}_L constituted by one block, \mathbf{G}^1 and \mathbf{G}^2 respectively. These blocks generate the subgroups Λ_1 and Λ_2 respectively. The subgroup Λ_1 is denoted by Λ_1^F because it is used to generate the MIMO symbols originating from a same state. In the same way, the subgroup Λ_2 is denoted by Λ_1^M because it is used to generate the MIMO symbols merging to a same state. If Λ is the set of the generated MIMO symbols, then each coset of the quotient group Λ/Λ_1^F [26] contains the MIMO symbols originating from a same state. Moreover, each coset of the quotient group Λ/Λ_1^M contains the MIMO symbols merging into a same state. As stated by the property 3 of the coset partitioning, the EDs between the elements of each coset of Λ/Λ_1^F and Λ/Λ_1^M must be maximized. Thus, Λ_1^F and Λ_1^M must be optimal blocks.

For example, a 8-state 8-PSK STTC with n_T transmit antennas is analysed. The generator matrix is given by $\mathbf{G} = [Y_1 Y_2 Y_4 | Y_8 Y_{16} Y_{32}]$. This code is represented in Fig. 3 where $Y_i + \Lambda_1^F$ and $Y_{i'} + \Lambda_1^M$ are cosets of $\mathbb{Z}_8^{n_T}$ with $i \in \{0, 1, 2, 3, 4, 5, 6, 7\}$ and $i' \in \{0, 8, 16, 24, 32, 40, 48, 56\}$. In the case of 8-PSK modulation, to respect property 3 of the coset partitioning, the EDs between the elements of each subgroup Λ_1^M and Λ_1^F must be maximized i.e. the first and the last blocks are optimal.

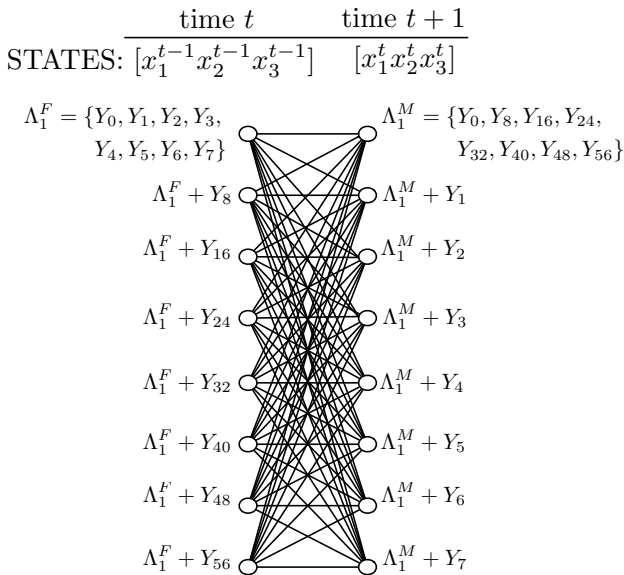

Fig. 3. 8-state 8-PSK STTC.

The sets of optimal blocks are found after an ex-

haustive search. The optimal 4-PSK blocks contain one element of \mathcal{C}_0^* and one element of a coset relative to the first element. Thus, the optimal blocks are based on the permutation of the lines and/or the columns of the following blocks:

- For 2 transmit antennas: $\begin{bmatrix} 0 & 2 \\ 2 & 1/3 \end{bmatrix}^T$.
- For 3 transmit antennas: $\begin{bmatrix} 0 & 2 & 2 \\ 2 & 1/3 & 1/3 \end{bmatrix}^T$.
- For 4 transmit antennas: $\begin{bmatrix} 0 & 0 & 2 & 2 \\ 0 & 2 & 1/3 & 1/3 \end{bmatrix}^T$.
- For 5 transmit antennas: $\begin{bmatrix} 0 & 0 & 2 & 2 & 2 \\ 2 & 2 & 1/3 & 1/3 & 1/3 \end{bmatrix}^T$.
- For 6 transmit antennas: $\begin{bmatrix} 0 & 0 & 2 & 2 & 2 & 2 \\ 2 & 2 & 1/3 & 1/3 & 1/3 & 1/3 \end{bmatrix}^T$.
- For 7 transmit antennas: $\begin{bmatrix} 0 & 0 & 2 & 2 & 2 & 2 & 2 \\ 2 & 2 & 1/3 & 1/3 & 1/3 & 1/3 & 1/3 \end{bmatrix}^T$.
- For 8 transmit antennas: $\begin{bmatrix} 0 & 0 & 2 & 2 & 2 & 2 & 2 & 2 \\ 2 & 2 & 1/3 & 1/3 & 1/3 & 1/3 & 1/3 & 1/3 \end{bmatrix}^T$.

The notation "1/3" must be read "1 or 3".

Let us consider the distance spectrum of a block of \mathbf{G} , i.e. the repartition of EDs between 2 different MIMO symbols generated by the block. The distance spectrum of each proposed block is optimal and given in Figs. 4 and 5. In Fig. 4, the black, gray and white bars correspond to the optimal blocks obtained for 2, 3 and 4 transmit antennas respectively. In Fig. 5, the black, dark gray, light gray and white bars correspond to the optimal blocks obtained for 5, 6, 7 and 8 transmit antennas respectively.

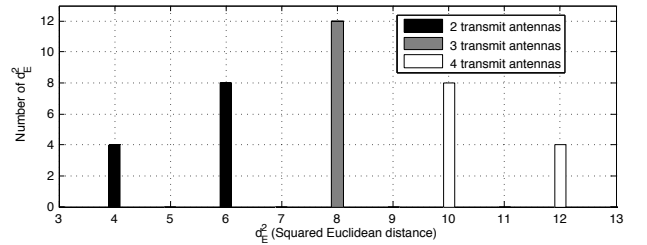

Fig. 4. Distance spectra of the 4-PSK optimal blocks for 2, 3 and 4 transmit antennas.

In the same way, the optimal blocks for 8-PSK modulation and for 2 to 6 transmit antennas are found after an exhaustive search. Thus, the optimal blocks are based on the permutation of the lines and/or the columns of the following blocks:

- For 2 transmit antennas: $\begin{bmatrix} 0 & 4 & 2/6 \\ 4 & 2/6 & 1/3/5/7 \end{bmatrix}$.
- For 3 transmit antennas: $\begin{bmatrix} 0 & 4 & 2/6 \\ 4 & g_1 & g_2 \\ 4 & g_1 & g_2 + 4 \text{ mod } 8 \end{bmatrix}$ with $g_1 \in \{2, 6\}$ and $g_2 \in \{1, 5\}$ or

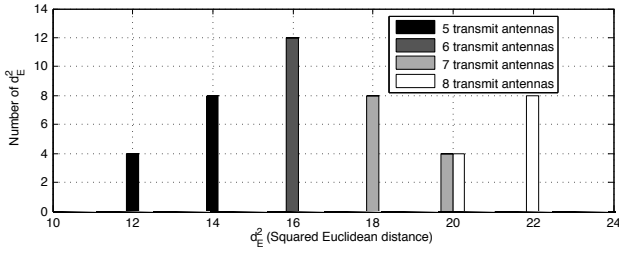

Fig. 5. Distance spectra of the 4-PSK optimal blocks for 5, 6, 7 and 8 transmit antennas.

$$\begin{bmatrix} 0 & 4 & 2/6 \\ 4 & g_1 & g_2 \\ 4 & g_1+4 \bmod 8 & g_3 \end{bmatrix} \text{ with } g_1 \in \{2, 6\} \text{ and } (g_2, g_3) \in \{(1, 3), (3, 1), (5, 7), (7, 5)\}.$$

- For 4 transmit antennas: $\begin{bmatrix} 0 & 0 & 4 \\ 0 & 4 & 6/2 \\ 4 & g_1 & g_2 \\ 4 & g_1 & g_3 \end{bmatrix}$ with $g_1 \in \{2, 6\}$ and $(g_2, g_3) \in \{(1, 5), (5, 1), (7, 3), (3, 7)\}$ or $\begin{bmatrix} 0 & 0 & 4 \\ 0 & 4 & 6/2 \\ 4 & g_1 & g_2 \\ 4 & g_1+4 \bmod 8 & g_3 \end{bmatrix}$ with $g_1 \in \{2, 6\}$ and $(g_2, g_3) \in \{(1, 3), (3, 1), (5, 7), (7, 5)\}$.

- For 5 transmit antennas: the number of blocks is equal to 192. They are based on some combinations $[V_0 V_1 V_2]$ with $V_0 = [0 \ 0 \ 4 \ 4 \ 4]^T \in \mathcal{C}_0$, $V_1 = [0 \ 4 \ v_1^1 \ v_2^1 \ v_3^1]^T \in \mathcal{E}_1$ with $v_i^1 \in \{2, 4\}$ and $V_2 = [4 \ 2/6 \ v_1^2 \ v_2^2 \ v_3^2]^T \in \mathcal{E}_2$ with $v_i^2 \in \{1, 3, 5, 7\}$.

- For 6 transmit antennas: the number of blocks is equal to 384. They are based on some combinations $[V_0 V_1 V_2]$ with $V_0 = [0 \ 0 \ 0 \ 4 \ 4 \ 4]^T \in \mathcal{C}_0$, $V_1 = [0 \ 4 \ 4 \ v_1^1 \ v_2^1 \ v_3^1]^T \in \mathcal{E}_1$ with $v_i^1 \in \{2, 4\}$ and $V_2 = [4 \ 2/6 \ 2/6 \ v_1^2 \ v_2^2 \ v_3^2]^T \in \mathcal{E}_2$ with $v_i^2 \in \{1, 3, 5, 7\}$.

The distance spectra generated by each proposed block are optimal and given in Figs. 6 and 7. In Fig. 6, the black, gray and white bars correspond to the blocks obtained for 2, 3 and 4 transmit antennas respectively. In Fig. 7, the black and white bars correspond to the blocks obtained for 5 and 6 transmit antennas respectively.

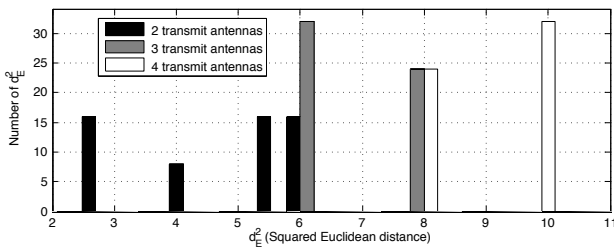

Fig. 6. Distance spectra of the 8-PSK optimal blocks for 2, 3 and 4 transmit antennas.

In order to obtain the best 2^n -state 2^n -PSK codes, each combination of optimal blocks \mathbf{G}^1 and \mathbf{G}^2 must

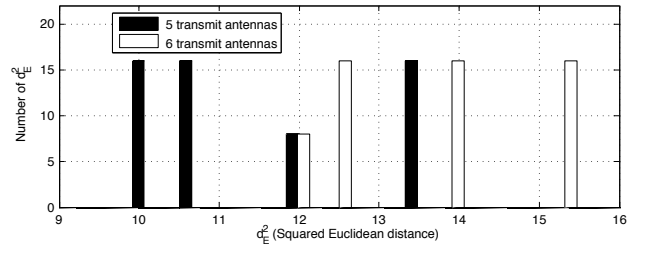

Fig. 7. Distance spectra of the 8-PSK optimal blocks for 5 and 6 transmit antennas.

be analyzed. Between the obtained codes, those with the best CEDs have the best performance.

E. Design example for 16-state 4-PSK STTCs

This section explains the design of 16-state 4-PSK STTCs with n_T transmit antennas. The MIMO symbols belong to $\mathbb{Z}_4^{n_T}$. This group can be divided into 2 sets: $\mathcal{E}_0 = \mathcal{C}_0$ and $\mathcal{E}_1 = \bigcup(P + \mathcal{C}_0)$ with $P \in \mathbb{Z}_4^{n_T} \setminus [0 \dots 0]^T$. The matrix \mathbf{G} has 3 blocks of 2 columns: $\mathbf{G}^i = [G_1^i, G_2^i]$ where $G_j^i \in \mathbb{Z}_4^{n_T}$ with $i = \overline{1, 3}$ and $j = \overline{1, 2}$. Hence, the generator matrix is $\mathbf{G} = [G_1^1 G_2^1 | G_1^2 G_2^2 | G_1^3 G_2^3]$.

The first and the last blocks must be optimal blocks. The second block must generate a subgroup and maximize the minimal value of the CED computed for all pairs of different codewords (\mathbf{E}, \mathbf{S}) .

In the case of a 16-state 4-PSK STTC designed with the coset partitioning, the trellis can be represented as shown by Fig. 8. On the left and right sides of the trellis, the cosets of the MIMO symbols Y_i with $i = \overline{0, 63}$ respectively originating from and merging into a same state are represented.

In this case, the generator matrix is $\mathbf{G} = [Y_1 Y_2 | Y_4 Y_8 | Y_{16} Y_{32}]$. To obtain the best \mathbf{G} , there are two steps:

- The selection of \mathbf{G}^1 and \mathbf{G}^3 is identical to the previous section. Thus, \mathbf{G}^1 and \mathbf{G}^3 correspond to one of the optimal blocks proposed in the previous section after permutation of lines and columns.
- The second step is the selection of the block \mathbf{G}^2 . Its columns must be selected via the previous stated properties of the coset partitioning in order to obtain a subgroup and increase the minimal value of the CED computed for all pairs of different codewords (\mathbf{E}, \mathbf{S}) .

In order to obtain the best codes, each combination of the blocks \mathbf{G}^1 , \mathbf{G}^2 and \mathbf{G}^3 selected as shown in this paragraph must be analyzed. Between the obtained codes, those with the best CEDs have the best performance.

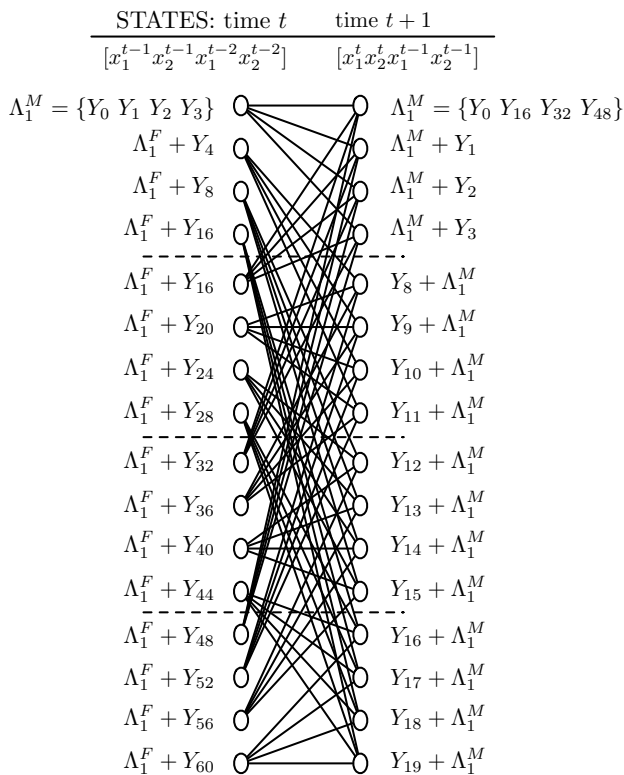

Fig. 8. 16-state 4-PSK STTC.

Remark: Some codes may have null vectors for the first i null columns in the $(\nu + 1)^{th}$ block with $0 < i < n$ as the Chen's 8-state 4-PSK STTCs with 3 transmit antennas given by

$$\mathbf{G} = \begin{bmatrix} 2 & 2 & 2 & 1 & 0 & 0 \\ 2 & 0 & 1 & 2 & 0 & 2 \\ 2 & 3 & 1 & 0 & 0 & 2 \end{bmatrix}. \quad (46)$$

In this case, the number of states is $2^{n\nu-i}$. The columns which generate the subgroup Λ_1^M (containing the MIMO symbols which merge into the same state) are the first i columns of the ν^{th} block and the last $(n - i)$ columns of the $(\nu + 1)^{th}$ block.

F. Example of computing-time reduction for 4-PSK STTCs

To emphasize the usefulness of the coset partitioning, this section shows the reduction of the computing-time obtained by using the new coset partitioning method. To find the best codes, the minimal CED must be computed. To reduce the search time, the objective is to limit the analysis to the smallest set containing the best codes. Tables I and II show the number of codes generated with the exhaustive search and the coset partitioning. The percentage of codes generated by the coset partitioning for 4-state 4-PSK STTCs with 2 to 6 transmit antennas and for 16-state 4-PSK STTCs with 2 to 5 transmit antennas is also given in these tables.

The total time to find the best STTCs is reduced to $3.4 \times 10^{-3} \%$ of the search time in the case of an exhaustive search. This computing-time can be further reduced when the number of transmit antennas and the number of states increases.

TABLE I
NUMBER OF 4-STATE 4-PSK STTCs

n_T	Number of codes		Percentage of computed codes
	Exhaustive search	Coset partitioning	
2	$4^8 = 65,536$	64	$9.77 \times 10^{-2} \%$
3	$4^{12} = 16,777,216$	576	$3.4 \times 10^{-3} \%$
4	$4^{16} = 4.295 \times 10^{09}$	4,096	$9.536 \times 10^{-5} \%$
5	$4^{20} = 1.099 \times 10^{12}$	14,400	$2.328 \times 10^{-6} \%$
6	$4^{24} = 2.814 \times 10^{14}$	230,400	$8.185 \times 10^{-8} \%$

TABLE II
NUMBER OF 16-STATE 4-PSK STTCs

n_T	Number of codes		Percentage of computed codes
	Exhaustive search	Coset partitioning	
2	$4^{12} = 65,536$	2,688	$2.6 \times 10^{-3} \%$
3	$4^{18} = 6.871 \times 10^{10}$	120,960	$1.760 \times 10^{-4} \%$
4	$4^{24} = 2.814 \times 10^{14}$	1,904,640	$6.766 \times 10^{-7} \%$
5	$4^{30} = 1.152 \times 10^{18}$	54.925×10^9	$4.339 \times 10^{-9} \%$

Several methods have been proposed to design STTCs. In [15], Chen *et al.* have given a suboptimal method which consists in making an exhaustive search to find the best STTCs with 2 transmit antennas. To search the codes with $n_T \geq 3$ transmit antennas, they keep the lines containing the coefficients corresponding to the transmit antennas of the best STTCs with $n_T - 1$ transmit antennas. An exhaustive search has been performed only for the coefficients of the n_T^{th} transmit antenna. For instance, in the case of 4-state 4-PSK STTCs with 3 transmit antennas, the percentage of codes generated by Chen is 0.39% of all possible codes. The number of STTCs is consequently reduced but this method is suboptimal. Thus, it is possible to find STTCs with better performance.

Abdool-Rassool *et al.* have also proposed a method to generate 4-PSK codes [18] exploiting the symmetry of PSK constellations and the permutations of the lines of \mathbf{G} . For the 4-state 4-PSK STTCs with 3 transmit antennas, the number of generated codes corresponds to 8.33 % of all possible codes.

In [22] and [23], the class of balanced codes is used to search the best STTCs, but the duration to compute these codes is longer than using the coset partitioning method presented in this paper.

V. NEW CODES

In this section, examples of 4-PSK and 8-PSK STTCs are presented. For each code, the minimal rank r and the minimal CED $d_{E,\min}^2$ computed for all pairs of different codewords are given. Tables III and IV show new codes and Chen's codes with 3 transmit antennas and 4 transmit antennas respectively. The Chen's codes denoted by * can be designed with the coset partitioning. The performance of these codes is identical to the new corresponding codes. Tables V and VI show new codes and Rassool's codes with 5 and 6 transmit antennas respectively.

TABLE III
NEW 4-PSK CODES BASED ON THE EUCLIDEAN DISTANCE
CRITERION WITH 3 TRANSMIT ANTENNAS

Number of states	Code	\mathbf{G}	r	$d_{E,\min}^2$
4	Chen <i>et al.</i> *	$\begin{bmatrix} 0 & 2 & 1 & 2 \\ 2 & 3 & 2 & 0 \\ 2 & 3 & 3 & 2 \end{bmatrix}$	2	16
	New 1	$\begin{bmatrix} 0 & 2 & 2 & 1 \\ 2 & 1 & 0 & 2 \\ 2 & 1 & 2 & 3 \end{bmatrix}$	2	16
8	Chen <i>et al.</i>	$\begin{bmatrix} 2 & 2 & 2 & 1 & 0 & 0 \\ 2 & 0 & 1 & 2 & 0 & 2 \\ 2 & 3 & 1 & 0 & 0 & 2 \end{bmatrix}$	2	20
	New 2	$\begin{bmatrix} 0 & 2 & 2 & 3 & 0 & 3 \\ 2 & 1 & 2 & 3 & 0 & 3 \\ 2 & 3 & 2 & 1 & 0 & 3 \end{bmatrix}$	2	20
16	Chen <i>et al.</i> *	$\begin{bmatrix} 1 & 2 & 1 & 2 & 3 & 2 \\ 2 & 0 & 3 & 2 & 2 & 0 \\ 1 & 2 & 2 & 0 & 1 & 2 \end{bmatrix}$	2	24
	New 3	$\begin{bmatrix} 0 & 2 & 1 & 2 & 2 & 0 \\ 2 & 1 & 2 & 0 & 3 & 2 \\ 2 & 1 & 3 & 2 & 1 & 2 \end{bmatrix}$	2	24
32	Chen <i>et al.</i>	$\begin{bmatrix} 0 & 2 & 2 & 1 & 1 & 2 & 0 & 2 \\ 2 & 2 & 3 & 2 & 2 & 3 & 0 & 0 \\ 2 & 0 & 3 & 2 & 2 & 1 & 0 & 0 \end{bmatrix}$	2	24
	New 4	$\begin{bmatrix} 2 & 1 & 2 & 3 & 0 & 2 & 0 & 2 \\ 2 & 1 & 2 & 1 & 2 & 3 & 0 & 3 \\ 0 & 2 & 2 & 1 & 2 & 1 & 0 & 3 \end{bmatrix}$	3	24
64	Chen <i>et al.</i>	$\begin{bmatrix} 0 & 2 & 3 & 2 & 3 & 0 & 3 & 2 \\ 2 & 2 & 1 & 2 & 3 & 0 & 2 & 0 \\ 2 & 0 & 0 & 2 & 2 & 3 & 1 & 1 \end{bmatrix}$	2	28
	New 5	$\begin{bmatrix} 2 & 3 & 2 & 3 & 2 & 1 & 2 & 1 \\ 0 & 2 & 0 & 2 & 2 & 3 & 0 & 2 \\ 2 & 1 & 0 & 2 & 2 & 3 & 2 & 1 \end{bmatrix}$	3	32

New 4-PSK codes with 7 and 8 transmit antennas are proposed in Table VII. Table VIII shows Chen's 8-PSK codes with 3 and 4 transmit antennas and new 8-PSK codes with 3 to 6 transmit antennas. In the literature, neither 4-PSK STTC with more than 6 transmit antennas nor 8-PSK STTC with more than 4 transmit antennas have been proposed.

For each new proposed code, the minimal rank computed for all pairs of different codewords is 2. Thus, the performance is governed by the trace criterion if the number of transmit antennas is 2 or more.

The traces of some proposed codes are equal to the trace of the corresponding Chen's or Rassool's codes.

TABLE IV
NEW 4-PSK CODES BASED ON THE EUCLIDEAN DISTANCE
CRITERION WITH 4 TRANSMIT ANTENNAS

Number of states	Code	\mathbf{G}	r	$d_{E,\min}^2$
4	Chen <i>et al.</i>	$\begin{bmatrix} 0 & 2 & 1 & 2 \\ 2 & 3 & 2 & 0 \\ 2 & 3 & 3 & 2 \\ 0 & 2 & 2 & 1 \end{bmatrix}$	2	20
	New 6	$\begin{bmatrix} 0 & 2 & 1 & 2 \\ 2 & 1 & 3 & 2 \\ 2 & 1 & 1 & 2 \\ 2 & 3 & 2 & 0 \end{bmatrix}$	2	20
8	Chen <i>et al.</i> *	$\begin{bmatrix} 2 & 2 & 2 & 1 & 0 & 0 \\ 2 & 0 & 1 & 2 & 0 & 2 \\ 2 & 3 & 1 & 0 & 0 & 2 \\ 2 & 1 & 2 & 3 & 0 & 1 \end{bmatrix}$	2	26
	New 7	$\begin{bmatrix} 2 & 1 & 2 & 1 & 0 & 3 \\ 0 & 2 & 2 & 1 & 0 & 1 \\ 2 & 1 & 2 & 3 & 0 & 3 \\ 2 & 1 & 2 & 1 & 0 & 1 \end{bmatrix}$	2	26
16	Chen <i>et al.</i> ²	$\begin{bmatrix} 1 & 2 & 1 & 2 & 3 & 2 \\ 2 & 0 & 3 & 2 & 2 & 0 \\ 1 & 2 & 2 & 0 & 1 & 2 \\ 1 & 2 & 2 & 0 & 3 & 2 \end{bmatrix}$	2	32
	New 8	$\begin{bmatrix} 1 & 2 & 2 & 0 & 3 & 2 \\ 3 & 2 & 3 & 2 & 1 & 2 \\ 2 & 0 & 3 & 2 & 1 & 2 \\ 1 & 2 & 2 & 0 & 2 & 0 \end{bmatrix}$	2	32
32	Chen <i>et al.</i>	$\begin{bmatrix} 0 & 2 & 2 & 1 & 1 & 2 & 0 & 2 \\ 2 & 2 & 3 & 2 & 2 & 3 & 0 & 0 \\ 2 & 0 & 3 & 2 & 2 & 1 & 0 & 0 \\ 2 & 1 & 2 & 0 & 1 & 0 & 0 & 2 \end{bmatrix}$	3	36
	New 9	$\begin{bmatrix} 2 & 1 & 2 & 1 & 2 & 3 & 0 & 3 \\ 0 & 2 & 2 & 3 & 2 & 3 & 0 & 1 \\ 2 & 3 & 2 & 1 & 0 & 2 & 0 & 2 \\ 2 & 3 & 2 & 1 & 0 & 2 & 0 & 2 \end{bmatrix}$	3	36
64	Chen <i>et al.</i>	$\begin{bmatrix} 0 & 2 & 3 & 2 & 3 & 0 & 3 & 2 \\ 2 & 2 & 1 & 2 & 3 & 0 & 2 & 0 \\ 2 & 0 & 0 & 2 & 2 & 3 & 1 & 1 \\ 1 & 2 & 2 & 0 & 2 & 1 & 3 & 2 \end{bmatrix}$	2	38
	New 10	$\begin{bmatrix} 2 & 3 & 2 & 1 & 2 & 3 & 0 & 2 \\ 2 & 3 & 0 & 2 & 2 & 3 & 2 & 3 \\ 0 & 2 & 2 & 1 & 2 & 3 & 2 & 1 \\ 2 & 1 & 2 & 1 & 0 & 2 & 2 & 3 \end{bmatrix}$	4	40

However, for the new codes, the minimum ED between the elements generated by the first and the last blocks is greater than the minimum ED between the elements generated by the first and the last blocks of the corresponding Chen's or Rassool's codes. For example, three cases are analyzed:

- Chen's 4-state 4-PSK STTCs with 4 transmit antennas. The distance spectra of the first and the last blocks noted respectively \mathbf{G}^1 and \mathbf{G}^2 are shown in Fig. 9. The distance spectra of the first and the last blocks of the corresponding new code are presented in Fig. 4 by the white bars.
- Rassool's 16-state 4-PSK STTCs with 5 transmit antennas. The distance spectra of the first and the last blocks noted respectively \mathbf{G}^1 and \mathbf{G}^3 are shown in Fig. 10. The distance spectra of the first and the last blocks of the corresponding new code are presented in Fig. 5 by the black bars.
- Chen's 8-state 8-PSK STTCs with 4 transmit antennas. The distance spectra of the first and the last

TABLE V
4-PSK STTCs BASED ON THE EUCLIDEAN DISTANCE CRITERION
WITH 5 TRANSMIT ANTENNAS

Number of states	Code	\mathbf{G}	r	$d_{E,\min}^2$
4	Rassool <i>et al.</i>	$\begin{bmatrix} 2 & 3 & 2 & 0 \\ 0 & 2 & 3 & 2 \\ 3 & 2 & 2 & 3 \\ 2 & 3 & 2 & 1 \\ 0 & 2 & 3 & 2 \end{bmatrix}$	2	26
	New 11	$\begin{bmatrix} 2 & 1 & 3 & 2 \\ 0 & 2 & 3 & 2 \\ 2 & 1 & 2 & 0 \\ 2 & 3 & 1 & 2 \\ 0 & 2 & 2 & 0 \end{bmatrix}$	2	26
16	Rassool <i>et al.</i>	$\begin{bmatrix} 2 & 0 & 1 & 2 & 2 & 0 \\ 1 & 2 & 3 & 2 & 1 & 2 \\ 3 & 2 & 2 & 0 & 1 & 2 \\ 2 & 1 & 0 & 2 & 2 & 3 \\ 1 & 2 & 2 & 0 & 3 & 2 \end{bmatrix}$	2	40
	New 12	$\begin{bmatrix} 2 & 3 & 2 & 1 & 2 & 1 \\ 2 & 1 & 2 & 1 & 2 & 1 \\ 0 & 2 & 2 & 1 & 0 & 2 \\ 0 & 2 & 0 & 2 & 2 & 3 \\ 2 & 3 & 2 & 1 & 0 & 2 \end{bmatrix}$	3	40
32	Rassool <i>et al.</i>	$\begin{bmatrix} 2 & 1 & 2 & 3 & 0 & 3 & 0 & 1 \\ 2 & 3 & 2 & 0 & 1 & 0 & 0 & 2 \\ 2 & 2 & 1 & 2 & 2 & 1 & 0 & 0 \\ 2 & 0 & 1 & 2 & 2 & 3 & 0 & 0 \\ 0 & 2 & 2 & 3 & 3 & 2 & 0 & 2 \end{bmatrix}$	3	44
	New 13	$\begin{bmatrix} 2 & 1 & 2 & 3 & 0 & 3 & 0 & 1 \\ 2 & 3 & 2 & 0 & 1 & 0 & 0 & 2 \\ 2 & 2 & 1 & 2 & 2 & 1 & 0 & 0 \\ 2 & 0 & 1 & 2 & 2 & 3 & 0 & 0 \\ 0 & 2 & 2 & 3 & 3 & 2 & 0 & 2 \end{bmatrix}$	3	44
64	New 14	$\begin{bmatrix} 0 & 2 & 1 & 2 & 2 & 3 & 0 & 2 \\ 2 & 1 & 2 & 0 & 2 & 3 & 2 & 1 \\ 0 & 2 & 2 & 0 & 0 & 2 & 0 & 2 \\ 2 & 3 & 1 & 2 & 2 & 1 & 2 & 1 \\ 2 & 1 & 1 & 2 & 0 & 2 & 2 & 1 \end{bmatrix}$	3	50

blocks noted respectively \mathbf{G}^1 and \mathbf{G}^2 are shown in Fig. 11. The distance spectra of the first and the last blocks of the corresponding new code are presented in Fig. 6 by the white bar.

The elements generated by the first and the last blocks of generator matrices are the MIMO signals originating from and merging to a same state. As stated by rule 2 of set partitioning proposed by Ungerboeck (and property 3 of coset partitioning), for the new codes, these elements are separated by the largest ED. Besides, the minimum CED of the published codes is equal to or smaller than the minimum CED of the new corresponding codes.

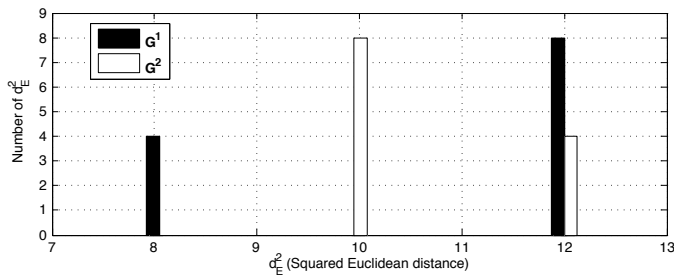

Fig. 9. Distance spectra of the blocks of the Chen's 4-state 4-PSK STTC with 4 transmit antennas.

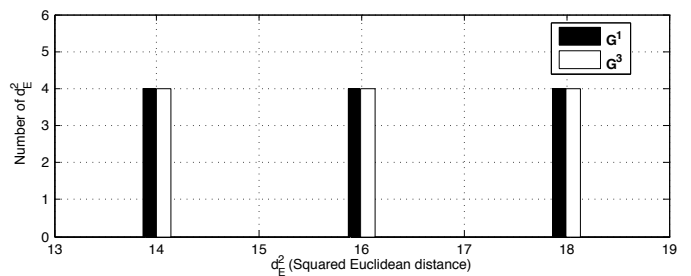

Fig. 10. Distance spectra of the blocks of the Rassool's 16-state 4-PSK STTC with 6 transmit antennas.

VI. CODES PERFORMANCE

The performance of each code is evaluated by simulation over Rayleigh fading channel. The channel fading coefficients are independent samples of a complex Gaussian process with zero mean and variance 0.5 per dimension. These channel coefficients are assumed to be known by the decoder. Each input binary frame consists of $130 \times n$ bits. For the simulation, there are 2 receive antennas. The decoding is performed by the Viterbi's

TABLE VI
4-PSK STTCs BASED ON THE EUCLIDEAN DISTANCE CRITERION
WITH 6 TRANSMIT ANTENNAS

Number of states	Code	\mathbf{G}	r	$d_{E,\min}^2$
4	Rassool <i>et al.</i>	$\begin{bmatrix} 0 & 2 & 1 & 2 \\ 1 & 2 & 2 & 0 \\ 0 & 2 & 1 & 2 \\ 2 & 1 & 2 & 0 \\ 1 & 2 & 2 & 1 \\ 2 & 1 & 2 & 3 \end{bmatrix}$	2	32
	New 15	$\begin{bmatrix} 2 & 3 & 1 & 2 \\ 0 & 2 & 3 & 2 \\ 0 & 2 & 2 & 0 \\ 2 & 1 & 2 & 0 \\ 2 & 1 & 1 & 2 \\ 2 & 3 & 1 & 2 \end{bmatrix}$	2	32
16	Rassool <i>et al.</i>	$\begin{bmatrix} 1 & 2 & 2 & 0 & 3 & 2 \\ 3 & 2 & 3 & 2 & 1 & 2 \\ 2 & 0 & 1 & 2 & 2 & 0 \\ 1 & 2 & 2 & 0 & 1 & 2 \\ 2 & 1 & 0 & 2 & 2 & 3 \\ 2 & 3 & 0 & 2 & 2 & 1 \end{bmatrix}$	2	48
	New 16	$\begin{bmatrix} 2 & 3 & 0 & 2 & 0 & 2 \\ 0 & 2 & 2 & 1 & 0 & 2 \\ 2 & 1 & 2 & 1 & 2 & 1 \\ 0 & 2 & 2 & 1 & 2 & 3 \\ 2 & 1 & 0 & 2 & 2 & 3 \\ 2 & 3 & 2 & 1 & 2 & 1 \end{bmatrix}$	3	48
32	Rassool <i>et al.</i>	$\begin{bmatrix} 1 & 2 & 3 & 1 & 2 & 0 & 0 & 3 \\ 2 & 2 & 3 & 2 & 2 & 3 & 0 & 0 \\ 0 & 2 & 2 & 1 & 1 & 2 & 0 & 2 \\ 2 & 0 & 3 & 2 & 2 & 1 & 0 & 0 \\ 2 & 3 & 2 & 1 & 0 & 1 & 0 & 3 \\ 2 & 1 & 2 & 0 & 3 & 0 & 0 & 2 \end{bmatrix}$	3	52
	New 17	$\begin{bmatrix} 0 & 2 & 2 & 1 & 0 & 2 & 0 & 2 \\ 0 & 2 & 2 & 1 & 2 & 3 & 0 & 1 \\ 2 & 1 & 2 & 3 & 0 & 0 & 0 & 2 \\ 2 & 1 & 0 & 2 & 2 & 3 & 0 & 1 \\ 2 & 3 & 2 & 1 & 2 & 1 & 0 & 3 \\ 2 & 1 & 2 & 1 & 2 & 1 & 0 & 1 \end{bmatrix}$	3	52
64	New 18	$\begin{bmatrix} 0 & 2 & 2 & 1 & 2 & 1 & 2 & 1 \\ 0 & 2 & 0 & 2 & 2 & 3 & 2 & 3 \\ 2 & 1 & 0 & 2 & 2 & 1 & 0 & 2 \\ 2 & 1 & 2 & 1 & 2 & 3 & 2 & 1 \\ 2 & 3 & 0 & 2 & 0 & 2 & 2 & 3 \\ 2 & 1 & 2 & 3 & 2 & 1 & 0 & 2 \end{bmatrix}$	4	64

TABLE VII
NEW 4-PSK STTCs BASED ON THE EUCLIDEAN DISTANCE
CRITERION WITH 7 AND 8 TRANSMIT ANTENNAS

n_T	Number of states	Code	\mathbf{G}	r	$d_{E,\min}^2$
7	16	New 19	$\begin{bmatrix} 0 & 2 & 2 & 1 & 2 & 1 \\ 0 & 2 & 0 & 2 & 2 & 1 \\ 2 & 3 & 0 & 2 & 2 & 3 \\ 2 & 1 & 2 & 3 & 2 & 3 \\ 2 & 1 & 2 & 3 & 2 & 1 \\ 2 & 3 & 0 & 2 & 0 & 2 \\ 2 & 3 & 2 & 1 & 0 & 2 \end{bmatrix}$	3	56
8	16	New 20	$\begin{bmatrix} 0 & 2 & 2 & 3 & 2 & 3 \\ 0 & 2 & 2 & 1 & 2 & 3 \\ 0 & 2 & 0 & 2 & 2 & 3 \\ 2 & 1 & 2 & 1 & 2 & 3 \\ 2 & 1 & 2 & 3 & 2 & 1 \\ 2 & 1 & 0 & 2 & 0 & 2 \\ 2 & 1 & 2 & 1 & 0 & 2 \\ 2 & 1 & 2 & 3 & 0 & 2 \end{bmatrix}$	3	64

TABLE VIII
NEW 8-PSK CODE BASED ON THE EUCLIDEAN DISTANCE
CRITERION

n_T	Number of states	Code	\mathbf{G}	r	$d_{E,\min}^2$
3	8	Chen	$\begin{bmatrix} 2 & 4 & 0 & 3 & 2 & 4 \\ 1 & 6 & 4 & 4 & 0 & 0 \\ 3 & 2 & 4 & 0 & 4 & 2 \end{bmatrix}$	2	12
		New 21	$\begin{bmatrix} 0 & 4 & 2 & 4 & 6 & 1 \\ 4 & 6 & 1 & 4 & 2 & 3 \\ 4 & 2 & 3 & 0 & 4 & 2 \end{bmatrix}$	2	12
4	8	Chen	$\begin{bmatrix} 2 & 4 & 0 & 3 & 2 & 4 \\ 1 & 6 & 4 & 4 & 0 & 0 \\ 3 & 2 & 4 & 0 & 4 & 2 \\ 7 & 2 & 4 & 5 & 4 & 0 \end{bmatrix}$	2	16.58
		New 22	$\begin{bmatrix} 4 & 2 & 1 & 0 & 0 & 4 \\ 4 & 6 & 3 & 0 & 4 & 2 \\ 0 & 4 & 2 & 4 & 2 & 3 \\ 0 & 0 & 4 & 4 & 6 & 7 \end{bmatrix}$	2	16
5	8	New 23	$\begin{bmatrix} 0 & 0 & 4 & 4 & 0 & 0 \\ 0 & 4 & 2 & 5 & 4 & 6 \\ 4 & 2 & 1 & 1 & 4 & 6 \\ 4 & 2 & 1 & 1 & 4 & 6 \\ 4 & 2 & 5 & 1 & 4 & 6 \end{bmatrix}$	2	20.58
6	8	New 24	$\begin{bmatrix} 4 & 6 & 5 & 4 & 0 & 0 \\ 4 & 6 & 5 & 5 & 4 & 6 \\ 4 & 6 & 1 & 2 & 0 & 4 \\ 0 & 4 & 6 & 2 & 0 & 4 \\ 0 & 4 & 2 & 7 & 4 & 2 \\ 0 & 0 & 4 & 5 & 4 & 2 \end{bmatrix}$	2	25.17

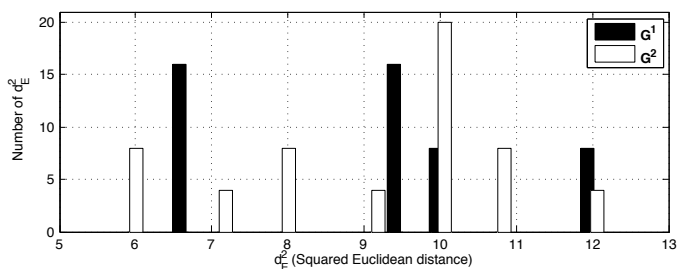

Fig. 11. Distance spectra of the blocks of the Chen's 8-state 8-PSK STTC with 4 transmit antennas.

algorithm. In the next figures, the SNR is computed as the ratio between the average received power by each antenna and the average power of the white noise.

In Figs. 12, 13, 14, 15, 16 and 17, the slow Rayleigh fading channels are considered. Figs. 12 and 13 show the performance of the 8/32/64-state 4-PSK codes for 3 transmit antennas presented in Table III and the performance of the 4/8/32/64-state 4-PSK codes for 4

transmit antennas presented in Table IV respectively. The performance of new codes and Rassool's codes with 5 and 6 transmit antennas of Table V and VI is shown in Figs. 14 and 15. The performance of the new codes presented in Table VII is shown in Fig. 16. Finally, Fig. 17 gives the performance of some 8-PSK codes presented in Table VIII. The codes with a large number of antennas and states can not be compared to published codes because no corresponding code is available in the literature. The other new STTCs slightly outperform the corresponding Chen's or Rassool's codes. However, the time to find the new STTCs using the coset partitioning is considerably reduced compared to the corresponding Chen's or Rassool's codes. In [9], Ionescu shows that the performance over slow and fast fading channels is closely related due to the relation between the ED distances and the product distances between two codewords. To emphasize this idea, the performance of the Rassool's codes with 5 and 6 transmit antennas and the new corresponding codes in the case of fast Rayleigh fading channels is compared for 2 receive antennas. Figs. 18 and 19 show that the performance improvement of the new STTCs for respectively 5 and 6 transmit antennas is similar to the one observed over slow Rayleigh fading channel.

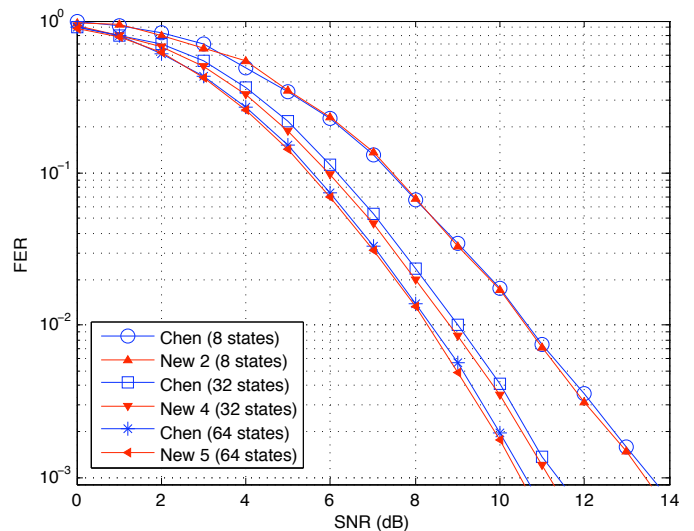

Fig. 12. Performance of 8/32/64-state 4-PSK STTCs with 3 transmit antennas over a slow Rayleigh fading channel.

VII. CONCLUSION

In this paper, a general method called coset partitioning to generate optimal 2^n -PSK STTCs for any number of transmit antennas and any number of states has been presented. This new method can be used to design easily and efficiently the optimal STTCs based on the

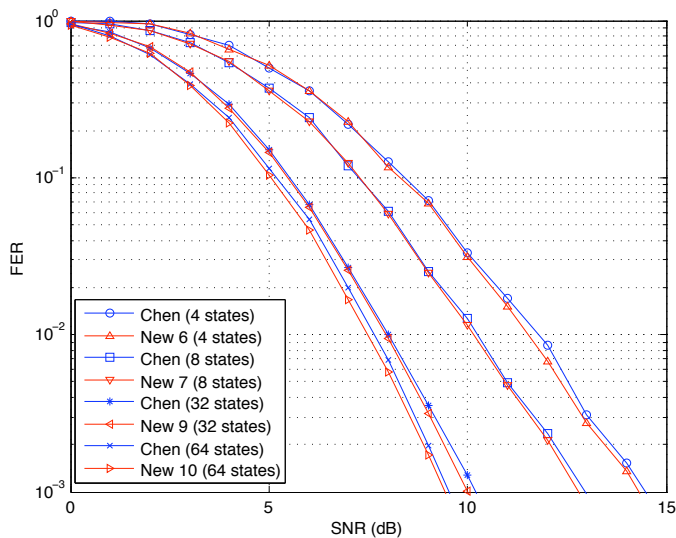

Fig. 13. Performance of 4/8/32/64-state 4-PSK STTCs with 4 transmit antennas over a slow Rayleigh fading channel.

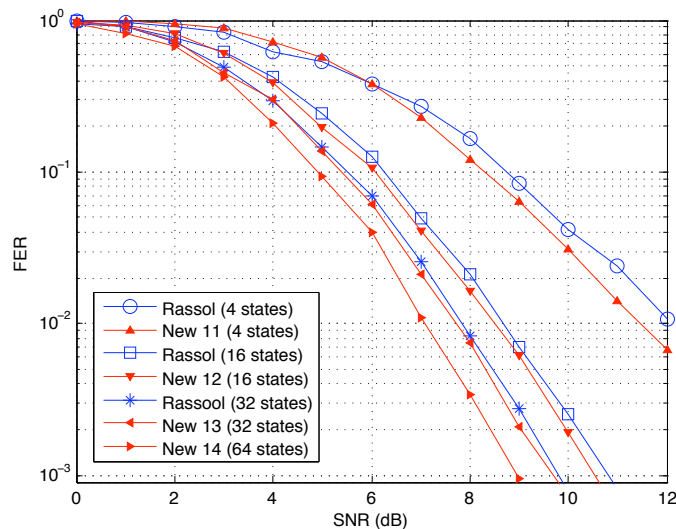

Fig. 14. Performance of 4/16/32/64-state 4-PSK STTCs with 5 transmit antennas over a slow Rayleigh fading channel.

ED criterion, avoiding the time-consuming exhaustive search. This method based on the Calderbank's approach is an extension to MIMO systems of the set partitioning proposed by Ungerboeck. The coset partitioning is simpler than the set partitioning because the MIMO symbols are separated into cosets, not into simple sets. Thereby, the number of STTCs to analyze is drastically reduced compared to the exhaustive search and the previous published methods, especially for large numbers of transmit antennas and states. Therefore, the time to generate optimal STTCs for any number of transmit antennas is considerably lowered. New optimal 4-PSK with 3 to 6 transmit antennas and 8-PSK STTCs with 3 to 4 transmit antennas designed via coset partitioning have also

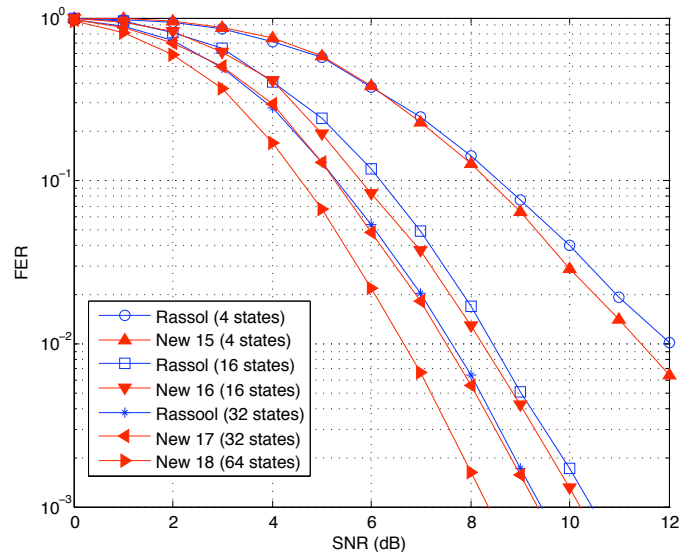

Fig. 15. Performance of 4/16/32/64-state 4-PSK STTCs with 6 transmit antennas over a slow Rayleigh fading channel.

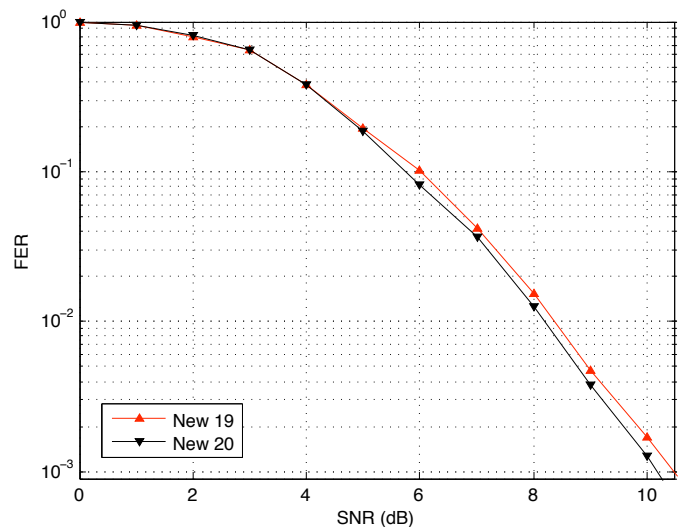

Fig. 16. Performance of 16-state 4-PSK STTCs with 7 and 8 transmit antennas over a slow Rayleigh fading channel.

been proposed. These new codes slightly outperform all corresponding published codes. Finally, the first 4-PSK STTC with 7 and 8 transmit antennas and 8-PSK STTCs with 5 and 6 transmit antennas have been presented and their performance evaluated by simulation.

REFERENCES

- [1] G. Ungerboeck, "Channel coding with multilevel/phase signals," *IEEE Trans. Inf. Theory*, vol. 28, pp. 55–67, Jan. 1982.
- [2] —, "Trellis-coded modulation with redundant signal sets part I: Introduction," *IEEE Comm. Magazine*, vol. 25, pp. 5–11, Feb. 1987.
- [3] —, "Trellis-coded modulation with redundant signal sets part II: State of the art," *IEEE Comm. Magazine*, vol. 25, pp. 12–21, Feb. 1987.

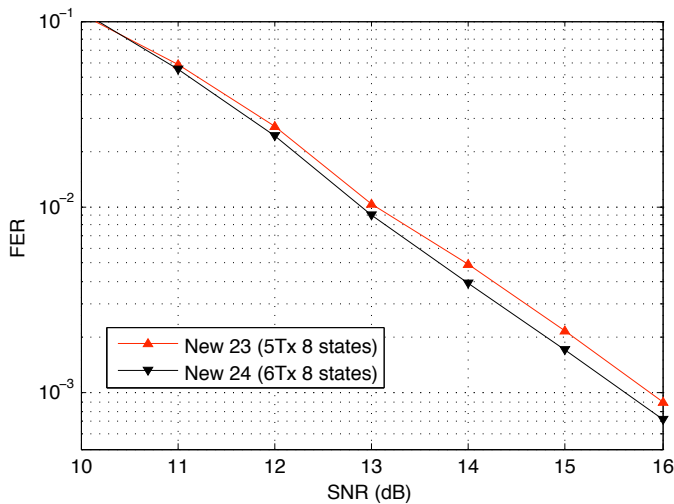

Fig. 17. Performance of 8-state 8-PSK STTCs with 4 and 6 transmit antennas over a slow Rayleigh fading channel.

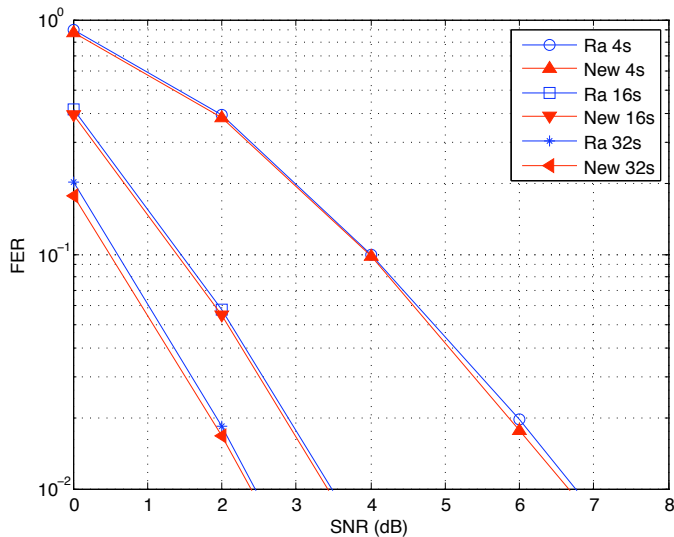

Fig. 18. Performance of 4/16/32-state 4-PSK STTCs with 5 transmit antennas over a fast Rayleigh fading channel.

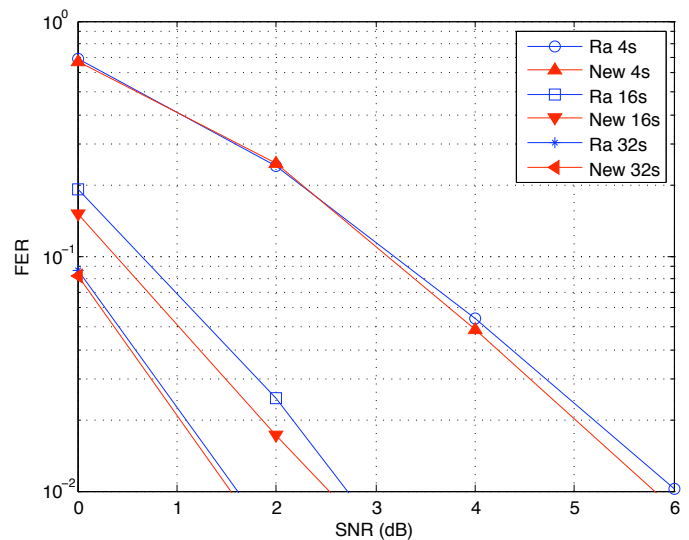

Fig. 19. Performance of 4/16/32-state 4-PSK STTCs with 6 transmit antennas over a fast Rayleigh fading channel.

- [4] A. Calderbank and N. Sloane, "New trellis codes based on lattices and cosets," *IEEE Trans. Inf. Theory*, vol. 33, pp. 177–195, Mar. 1987.
- [5] V. Tarokh, N. Seshadri, and A. Calderbank, "Space-time codes for high data rate wireless communication: Performance criterion and code construction," *IEEE Trans. Inf. Theory*, vol. 44, no. 2, pp. 744–765, Mar. 1998.
- [6] Z. Chen, J. Yuan, and B. Vucetic, "Improved space-time trellis coded modulation scheme on slow fading channels," *Electron. Lett.*, vol. 37, no. 7, pp. 440–441, Mar. 2001.
- [7] J. Yuan, Z. Chen, B. Vucetic, and W. Firmanto, "Performance and design of space-time coding in fading channels," *IEEE Trans. Comm.*, vol. 51, no. 12, pp. 1991–1996, Dec. 2003.
- [8] D. Ionescu, "New results on space-time code design criteria," in *Proc. IEEE WCNC 1999*, vol. 2, Sep. 1999, pp. 684–687.
- [9] —, "On space-time code design," *IEEE Trans. Wireless Comm.*, vol. 2, no. 1, pp. 20–28, Jan. 2003.
- [10] E. Biglieri and A. Tulino, "Designing space-time codes for large number of receiving antennas," *Electronics Letters*, vol. 37, no. 17, pp. 1073–1074, Aug. 2001.
- [11] E. Biglieri, G. Taricco, and A. Tulino, "Performance of space-time codes for a large number of antennas," *IEEE Trans. Inf. Theory*, vol. 48, no. 7, pp. 1794–1803, Jul. 2002.
- [12] C. Liao and V. Prabhhu, "Improved code design criteria for space-time codes over quasi-static flat fading channels," in *Proc. IEEE SPAWC 2005*, June 2005, pp. 7–11.
- [13] Y. Hong and A. Guillen i Fabregas, "New space-time trellis codes for two-antenna quasi-static channels," *IEEE Trans. Veh. Technol.*, vol. 56, no. 6, pp. 3581–3587, Nov. 2007.
- [14] Z. Chen, B. Vucetic, J. Yuan, and K. L. Lo, "Space-time trellis codes for 4-PSK with three and four transmit antennas in quasi-static flat fading channels," *IEEE Commun. Lett.*, vol. 6, no. 2, pp. 67–69, Feb. 2002.
- [15] —, "Space-time trellis codes with two, three and four transmit antennas in quasi-static flat fading channels," in *Proc. IEEE ICC 2002*, vol. 3, May 2002, pp. 1589–1595.
- [16] D. Bernier and F. Chan, "Improved space-time trellis codes with three and four transmit antennas," in *Proc. Canadian Conference on Electrical and Computer Engineering*, vol. 4, May 2004, pp. 2089–2093.
- [17] Q. Yan and R. Blum, "Improved space-time convolutional codes for quasi-static slow fading channels," *IEEE Trans. Wireless Comm.*, vol. 1, no. 4, pp. 563–571, Oct. 2002.
- [18] B. Abdool-Rassool, F. Heliot, L. Revelly, M. Dohler, R. Nakhai, and H. Aghvami, "Fast search techniques for obtaining space-time trellis codes for Rayleigh fading channels and its performance in CDMA systems," in *Proc. IEEE VTC 2003-Spring*, vol. 1, Apr. 2003, pp. 66–69.
- [19] B. Abdool-Rassool, M. Nakhai, F. Heliot, L. Revelly, and H. Aghvami, "Search for space-time trellis codes: novel codes for Rayleigh fading channels," *IEE Proc.-Commun.*, vol. 151, no. 1, pp. 25–31, Feb. 2004.
- [20] S. Baro, G. Bauch, and A. Hansmann, "Improved codes for space-time trellis-coded modulation," *IEEE Commun. Lett.*, vol. 4, no. 1, pp. 20–22, Jan. 2000.
- [21] J. O. Coleman, "Coset decomposition in lattices yields sample-block number systems," in *Proc. IEEE ISCAS 2002*, vol. II, May 2002, pp. 688–691.
- [22] T. Ngo, P. Viland, G. Zaharia, and J.-F. Helard, "Balanced

- QPSK space-time trellis codes,” *Electron. Lett.*, vol. 44., pp. 983 – 985, July 2008.
- [23] P. Viland, G. Zaharia, and J.-F. Héland, “A new method to design balanced space-time trellis codes for several transmit antennas,” in *Proc. IEEE GLOBECOM 2008*, Dec. 2008, pp. 1–5.
- [24] H. Jafarkhani and N. Seshadri, “Super-orthogonal space-time trellis codes,” *IEEE Trans. Inf. Theory*, vol. 49, no. 4, pp. 937 – 950, Apr. 2003.
- [25] Z. Yan and D. Ionescu, “Geometrical uniformity of a class of space-time trellis codes,” *IEEE Trans. Inf. Theory*, vol. 50, no. 12, pp. 3343 – 3347, Dec. 2004.
- [26] G. Forney, *Sphere Packings, lattice and groups*. Springer-Verlag (New York), 1988.

APPENDIX

A. Proof of proposition 1

The Lagrange’s theorem states that for a finite group Λ , the order of each subgroup Λ_l of Λ divides the order of Λ . In the case of 2^n -PSK, $\text{card}(\Lambda) = \text{card}(\mathbb{Z}_{2^n}^{n_T}) = 2^{nn_T}$, then $\text{card}(\Lambda_l) = 2^m$. Hence, $\text{card}(\Lambda_l)$ is an even number. The null element belongs to Λ_l and the opposite of each element is included in Λ_l . Thus, in order to obtain an even number for $\text{card}(\Lambda_l)$, there are at least one element $V_m \neq 0$ which respects $V_m = -V_m$. The elements of only \mathcal{C}_0 respect $V_m = -V_m$. Therefore, there is at least one element $V_m \in \mathcal{C}_0^*$.

B. Proof of proposition 2

As shown by property 1, there is at least one element which belongs to \mathcal{C}_0^* . Thus, if $V_1 \in \mathcal{C}_0^*$, $\Lambda_1 = \{0, V_1\}$ is a subgroup.

We consider that $m - 1$ elements have been selected to generate a subgroup Λ_{m-1} with $m = \overline{2, nn_T}$.

If we select $V_m \in \mathbb{Z}_{2^n}^{n_T} \setminus \Lambda_{m-1}$ such as $2V_m = Q \in \Lambda_{m-1}$, a set Λ_m is defined by

$$\Lambda_m = \Lambda_{m-1} \cup \mathcal{C}_{V_m} \quad (47)$$

where \mathcal{C}_{V_m} is a coset defined by

$$\mathcal{C}_{V_m} = V_m + \Lambda_{m-1}. \quad (48)$$

In order to show that Λ_m is a subgroup of $\mathbb{Z}_{2^n}^{n_T}$, the following propositions must be proved:

1) $0 \in \Lambda_m$.

Proof: As $\Lambda_m = \Lambda_{m-1} \cup (\Lambda_{m-1} + V_m)$ and $0 \in \Lambda_{m-1}$, we have $0 \in \Lambda_m$.

2) $\forall V_1, V_2 \in \Lambda_m, V_1 + V_2 \in \Lambda_m$.

Three cases are analyzed.

1st case: $\forall V_1, V_2 \in \mathcal{C}_{V_m}, V_1 = V_m + Q_1$ and $V_2 = V_m + Q_2$ with $Q_1, Q_2 \in \Lambda_{m-1}$. Thus, $V_1 + V_2 = 2V_m + Q_1 + Q_2$. As $2V_m \in \Lambda_{m-1}$ and Λ_{m-1} is a subgroup, $V_1 + V_2 \in \Lambda_{m-1} \subset \Lambda_m$.

2nd case: $\forall V_1 = V_m + Q_1 \in \mathcal{C}_{V_m}$ with $Q_1 \in \Lambda_{m-1}$ and $\forall V_2 \in \Lambda_{m-1}, V_1 + V_2 = V_m + Q_1 + V_2$. As

Λ_{m-1} is a subgroup, $Q_1 + V_2 \in \Lambda_{m-1}$. Therefore, $V_1 + V_2 \in \mathcal{C}_{V_m} \subset \Lambda_m$.

3rd case: $\forall V_1, V_2 \in \Lambda_{m-1}$. As Λ_{m-1} is a subgroup $V_1 + V_2 \in \Lambda_{m-1} \subset \Lambda_m$.

Thus, Λ_m is closed under addition.

3) $\forall V \in \Lambda_m, \exists -V \in \Lambda_m$ such as $V + (-V) \in \Lambda_m$.

Proof: as Λ_{m-1} is a subgroup, $-Q = -V_m + (-V_m) = -2V_m \in \Lambda_{m-1}$ with $V_m + (-V_m) = 0$ and $Q + (-Q) = 0$. So, we have

$$-V_m = V_m + (-2V_m) \in \mathcal{C}_{V_m} \subset \Lambda_m. \quad (49)$$

Therefore, using (48): $-V_m = V_m + Q' \in \mathcal{C}_{V_m}$ with $Q' \in \Lambda_{m-1}$. $\forall V_1 \in \mathcal{C}_{m-1}, V_1 = V_m + Q_1$ with $Q_1 \in \Lambda_{m-1}$. Because Λ_{m-1} is a subgroup, $-Q_1 \in \Lambda_{m-1}$. So, $-V_1 = -V_m + (-Q_1) = V_m + Q' + (-Q_1) \in \mathcal{C}_m \subset \Lambda_m$ because $Q' + (-Q_1) \in \Lambda_{m-1}$.

Therefore, the opposite of each element of Λ_m belongs to Λ_m .

Thus, if each element is selected within a coset relative to a generated element, the created set Λ_m is also a subgroup.