



HAL
open science

Current and Future Perspectives for Personalized Adaptive Learning

Milos Kravcik, Daniel Burgos, Stefano Ceri, Mohamed Amine Chatti, Alexandra Cristea, Paul de Bra, Vladan Devedžić, Erik Duval, Felix Mödritscher, Ambjörn Naeve, et al.

► **To cite this version:**

Milos Kravcik, Daniel Burgos, Stefano Ceri, Mohamed Amine Chatti, Alexandra Cristea, et al.. Current and Future Perspectives for Personalized Adaptive Learning. 2007. hal-00588805

HAL Id: hal-00588805

<https://hal.science/hal-00588805>

Submitted on 2 May 2011

HAL is a multi-disciplinary open access archive for the deposit and dissemination of scientific research documents, whether they are published or not. The documents may come from teaching and research institutions in France or abroad, or from public or private research centers.

L'archive ouverte pluridisciplinaire **HAL**, est destinée au dépôt et à la diffusion de documents scientifiques de niveau recherche, publiés ou non, émanant des établissements d'enseignement et de recherche français ou étrangers, des laboratoires publics ou privés.



PROLEARN

European Commission Sixth Framework Project (IST-507310)

Deliverable **D1.13**

Current and Future Perspectives for Personalized Adaptive Learning

Editor *Milos Kravcik*

Work Package *WP1*

Status *Version 1.1*

Date *14/01/2008*

The PROLEARN Consortium

1. Universität Hannover, L3S Research Center, Germany
2. Deutsches Forschungszentrum für Künstliche Intelligenz GmbH (DFKI), Germany
3. Open University (OU), UK
4. Katholieke Universiteit Leuven (K.U.Leuven) / ARIADNE Foundation, Belgium
5. Fraunhofer-Gesellschaft zur Förderung der angewandten Forschung e.V. (FHG), Germany
6. Wirtschaftsuniversität Wien (WUW), Austria
7. Universität für Bodenkultur, Zentrum für Soziale Innovation (CSI), Austria
8. École Polytechnique Fédérale de Lausanne (EPFL), Switzerland
9. Eigenössische Technische Hochschule Zürich (ETHZ), Switzerland
10. Politecnico di Milano (POLIMI), Italy
11. Jožef Stefan Institute (JSI), Slovenia
12. Universidad Politécnica de Madrid (UPM), Spain
13. Kungl. Tekniska Högskolan (KTH), Sweden
14. National Centre for Scientific Research "Demokritos" (NCSR), Greece
15. Institut National des Télécommunications (INT), France
16. Hautes Etudes Commerciales (HEC), France
17. Technische Universiteit Eindhoven (TU/e), The Netherlands
18. Rheinisch-Westfälische Technische Hochschule Aachen (RWTH), Germany
19. Helsinki University of Technology (HUT), Finland
20. Open University of The Netherlands (OUNL), The Netherlands
21. University of Warwick (Warwick), UK

Document Control

Title: Current and Future Perspectives for Personalized Adaptive Learning

Author/Editor: Milos Kravcik

E-mail: Milos.Kravcik@ou.nl

Amendment History

Version	Date	Author/Editor	Description/Comments
0.1	22/11/2007	Milos Kravcik	First Outline
0.2	14/12/2007		Draft with contributions from partners
0.3	17/12/2007		Snowflake effect added
1.1	14/01/2008		Adjustments according to the peer reviews

Contributors

Name	Company
Daniel Burgos	OUNL
Stefano Ceri	POLIMI
Mohamed Amine Chatti	RWTH
Alexandra Cristea	Warwick
Paul De Bra	TU/e
Vladan Devedzic	University Belgrade
Erik Duval	KUL
Milos Kravcik	OUNL
Felix Mödritscher	WUW
Ambjörn Naeve	KTH
Marcus Specht	OUNL
Fridolin Wild	WUW

Table of Contents

1	INTRODUCTION	5
2	PERSONALIZED ADAPTIVE LEARNING IN PROLEARN.....	7
2.1	ACTIVITIES AND EVENTS	7
2.1.1	AH2004 conference	7
2.1.2	PROLEARN Workshop on Personalized Adaptive Corporate Learning.....	7
2.1.3	PROLEARN Session at UM2005.....	8
2.1.4	UNFOLD/ProLearn Workshop on IMS Learning Design.....	8
2.1.5	AH2006 Conference	8
2.1.6	ICALT 2006 Conference.....	8
2.1.7	Other Events	8
2.2	DELIVERABLES	9
2.2.1	Requirements of Professional Learning	9
2.2.2	Solutions for Personalized Adaptive Learning.....	10
2.2.3	Learner Modelling.....	10
2.2.4	Interoperability.....	10
2.2.5	Privacy and Data Protection.....	10
2.2.6	Authoring.....	11
2.2.7	Interfacing with Corporate Training Systems	11
2.2.8	SECI-based Framework	11
2.2.9	Integration with IMS Learning Design.....	12
2.3	SELECTED PUBLICATIONS	12
2.4	COMMUNITY OF PRACTICE ABOUT ADAPTIVE LEARNING AND IMS LEARNING DESIGN	15
2.5	TRANSFER OF TACIT KNOWLEDGE.....	17
3	PROLEARN RELATED CONTRIBUTIONS IN PERSONALIZED ADAPTIVE LEARNING.....	18
3.1	PERSONAL LEARNING ENVIRONMENT FRAMEWORK	18
3.2	ADAPTIVE LEARNING SPACES.....	21
3.3	SUPPORTING SELF-DIRECTED LEARNING IN DISTRIBUTED WEB-ENVIRONMENTS	21
3.4	PERSONAL COMPETENCE MANAGEMENT	24
3.5	SEMANTIC WEB SERVICES FOR LEARNING.....	25
3.6	LEARNING OBJECT CONTEXT ONTOLOGY.....	26
4	TRENDS IN PERSONALIZED ADAPTIVE LEARNING	28
4.1	THE SNOWFLAKE EFFECT	29
4.2	THE LONG TAIL	29
4.3	THE WISDOM OF CROWDS	30
4.4	RESEARCH CHALLENGES	30
4.5	ROADMAP VISION STATEMENT 1	31
4.6	GRAPPLE PROJECT	32
5	CONCLUSION	34
6	ACKNOWLEDGEMENT.....	34
7	REFERENCES	34

1 Introduction

As this is the last deliverable in WP1, in JPA4 we planned the Deliverable 1.13 in the following way: “It will summarize the research achievements of WP1 and give an outlook to further research on personalized adaptive learning. This deliverable will bundle the key scientific publications made in academic journals and conference proceedings by WP1, showing adaptation from different views. A community of practice around IMS Learning Design and Personalized Adaptive Learning will be reported. The crucial issues of demand, integration, and sustainability (open source, open content policy, competency) will be addressed as well.”

First we can recall the original objectives, key issues and activities, which were articulated at the beginning of this project for WP1. The following general and long term objectives have been specified:

- Improving the efficiency and cost-effectiveness of learning
- Learning independent of time, place and pace
- Development of open systems and services
- Support of ubiquitous, experiential and contextualized learning
- Virtual collaborative learning communities

They implied these key issues:

- Which pedagogical models and learning theories are suitable for corporate e-Learning, mobile learning and learning on demand?
- What standards are needed to improve interoperability of various personalized adaptive learning tools as well as exchange of learner models and learning content?
- How can we implement personalized adaptive learning and assessment in open and distributed environments?
- How the learner modelling approaches should be further developed?
- How should new interfaces for data (including metadata) and relationship visualization look like?
- Which privacy and data protection issues should be considered?
- How can we evaluate the effectiveness of personalization and adaptive methods?

Consequently our activities were to aim at:

- Pedagogical models and learning theories for corporate learning
- Standardized learning solutions and personalization
- Adaptive learning and assessment in open environments

- Learner modelling
- User interface
- Privacy and data protection
- Evaluation of personalization and adaptation methods

This report is going to contain:

- A thorough description of deliverables, events, activities, selected publications
- A summary of the major contributions given by the PROLEARN network to personalized adaptive learning
- High-level view on where we stand and where we are heading in personalized adaptive learning

The rationale of this last report is to provide a short summary of achievements and visions, and this is also helpful in setting the stage for sustainability beyond the termination of network activities. In the next paragraphs we start with providing a summary of our work in WP1 on Personalized and Adaptive Learning. Then an introduction of a wider context and an outline of the state of the art in this field follow. Finally, we attempt to identify the main trends in personalization and learning generally, as well as its impact on sustainability of PROLEARN from our perspective.

2 Personalized Adaptive Learning in PROLEARN

This paragraph provides a summary of the work done in WP1, focusing especially on our activities and events, deliverables, as well as the community of practice. During the lifetime of the project WP1 has established cross-relationships with many other PROLEARN workpackages. Here are some relevant examples of this cooperation. We have used the FlashMeeting tool from WP2 for our virtual meetings. Our interoperability and reusability investigations from D1.2 (and related journal paper) partly overlap with WP4 activities regarding standardization of learning object metadata and its efficient usage. Originally considered D1.12 on requirements of learning process framework for competence-driven learning became part of D6.7 on business process-oriented learning in WP6. A SECI-based survey from WP7 informed D1.10, which served as an input for D7.7 presenting the PROLEARN framework for process-oriented learning and knowledge work. We have used the VCC portal from WP8 to collect feedback for our survey, which was included in D1.8. WP1 lecturers regularly attended the PROLEARN Summer School organized by WP9. We have developed the Vision Statement 1 of the Roadmap from WP12 and the “snowflake effect” concept explained in D12.13 is in line with the trends in personalized adaptive learning (see paragraph 4). As social software is a modern trend also in personalized adaptive learning, we reflected this aspect in D15.1 (published also as a journal paper) and D15.2 by WP15.

2.1 Activities and Events

In addition to the WP1 meetings, PROLEARN partners have organized several workshops on different aspects of personalized adaptive learning at relevant conferences (e.g. User Modeling, Adaptive Hypermedia, ICALT, and Hypertext). In this paragraph we provide an overview of these events. We shall keep organizing these types of workshops also in the future.

2.1.1 AH2004 conference

The Adaptive Hypermedia conferences are the major forums for the scientific exchange and presentation of research on adaptive hypermedia and adaptive web-based systems. Several PROLEARN participants are regularly in the program committee of this conference and in 2004 P. De Bra was the general chair, W. Nejdl the program chair, L. Aroyo a tutorials and workshops co-chair, and G.-J. Houben an industry track co-chair. During the conference the PROLEARN project was introduced to the participants. W. Nejdl explained the main PROLEARN objectives and M. Specht described the WP1 activities. The following workshop provided a forum for the participants to discuss issues related to interoperability of adaptive hypermedia systems.

2.1.2 PROLEARN Workshop on Personalized Adaptive Corporate Learning

In January 2005 WP1 has organized this workshop to identify critical issues in the field and propose possible solutions. Four invited speakers and more than 15 workshop participants met for two days. The main themes specified for this workshop were Pedagogy, Learning Design, Learner Modeling, Security & Privacy. For each of them invited relevant authorities presented

their view on the state of the art in the field and outlined perspectives for the future. The workshop participants had also a chance to present their results and experience related to the specified topics. Invited speakers: D. Leutner (Pädagogische Hochschule Erfurt), R. Koper (Open Universiteit Nederland), E. Melis (German Research Center for Artificial Intelligence DFKI), and Ch. D. Jensen (Technical University of Denmark).

2.1.3 PROLEARN Session at UM2005

User Modeling Conference is another important event in our field. At the UM 2005 Conference several PROLEARN people were in the program committee. WP1 has organized the PROLEARN session *Personalized Adaptive Learning on the Semantic Web* as part of the PerSWeb Workshop (<http://www.win.tue.nl/persweb/program.html>) about Personalization on the Semantic Web.

2.1.4 UNFOLD/ProLearn Workshop on IMS Learning Design

In September 2005 this joint workshop took place to provide an overview of current work in learning design. Around 60 participants attended this event. It was organized by the Open University of the Netherlands which joined the PROLEARN consortium later on.

2.1.5 AH2006 Conference

At the Adaptive Hypermedia and Adaptive Web-Based Systems Conference in 2006 one PROLEARN person was in the organizing committee (A. Cristea) and several our people were in the programme committee. PROLEARN partners have presented several papers and organized the following workshops there:

- SW-EL: Applications of semantic web technologies for adaptive educational hypermedia
- ADALE: Adaptive Learning - Building adaptive educational hypermedia with IMS Learning Design
- A3H: Authoring of Adaptive and Adaptable Hypermedia

2.1.6 ICALT 2006 Conference

The 6th IEEE International Conference on Advanced Learning Technologies took place in July 2006. Some of the PROLEARN partners have attended the event. They presented several papers and organized two workshops:

- ADALE: Adaptive Learning - Extending IMS Learning Design for Adaptive Instruction
- AWELS: Adaptive Web-Based Education and Learning Styles

Additionally, W. Nejdl had a keynote speech and R. Koper led a tutorial.

2.1.7 Other Events

Additional activities co-organized by PROLEARN people in the area of personalized adaptive learning include the following ones:

- AH 2004 workshop A3H: 2nd International workshop on Adaptive and adaptable Authoring
- AIED05 workshop A3H: 3rd International workshop on Adaptive and adaptable Authoring
- Hypertext'06 workshop APS: Joint International Workshop on Adaptivity, Personalization and the Semantic Web
- User Modeling'07 workshop A3H: 5th International workshop on Adaptive and adaptable Authoring
- Hypertext'07 track Practical Hypertext

2.2 Deliverables

Before this one, WP1 has prepared the following deliverables during the PROLEARN project (the table lists for each deliverable its number, title, editor, and month).

D1.4/D1.6	User interface requirements and solutions in corporate e-Learning / Specification of requirements and the state of the art in personalized adaptive learning especially regarding corporate e-Learning	FHG	M06
D1.1	Requirements and solutions for personalized adaptive learning and systematic description of personalized assessment tools	FHG	M12
D1.3	Learner models for web-based personalised adaptive learning: current solutions and open issues	TU/e	M12
D1.7	Web portal for professional education	FHG	M12
D1.2	Interoperability of adaptive learning components	FHG	M18
D1.5	Privacy and data protection in corporate e-Learning	JSI	M18
D1.8	Specification and prototyping of personalized workplace learning	L3S	M24
D1.9	Interfacing adaptive solutions with corporate training systems	TU/e	M30
D1.10	A SECI-based framework for learning processes @ work	KTH	M42
D1.11	Integration of adaptive learning processes with IMS Learning Design considering corporate requirements	OUNL	M42

2.2.1 Requirements of Professional Learning

We started by mapping the state of the art in personalized adaptive learning and requirements of professional learning in D1.4/D1.6. Five key user roles have been identified and for each role scenarios and use cases have been introduced. These use cases form the basis for derivation

of requirements. Realization of corporate training by e-learning means can save costs, streamline business processes, as well as bring new approaches to learning and training. The new training methods can help the end user to perform better, to speed the time to performance, and to learn the relevant knowledge or skill.

2.2.2 Solutions for Personalized Adaptive Learning

Then in D1.1 we analyzed the available solutions. Current learning environments are typically web based, but they usually do not take into account heterogeneous needs of users and provide the same learning material to students with different knowledge, objectives, interests, and in different contexts. Currently there is no technical standard for the communication between the various personalized adaptive learning tools as well as no metadata standard for meaningful exchange of learner model and learning content data.

2.2.3 Learner Modelling

D1.3 focused on learner modelling, as it is the core for achieving personalized and adaptive learning environments, which will be able to take into account the heterogeneous needs of users and provide them with tailored learning material suited for their knowledge level, learning objectives, personal interests and preferences. Currently there are no concrete and agreed upon standards for learner modelling, which makes it difficult to decide on modelling architectures, frameworks and approaches when building adaptive learning environments. Therefore, the deliverable presents an overview of most common learner (user) modelling architectures, approaches and current developments, to discuss their advantages and disadvantages and to outline the major challenges and open issues with respect to both the learner model elicitation and evaluation.

2.2.4 Interoperability

As interoperability is one of the crucial problems in this area, we analyzed it in D1.2 (published also as journal paper). Personalized adaptive learning requires semantic-based and context-aware systems to manage the Web knowledge efficiently as well as to achieve semantic interoperability between heterogeneous information resources and services. The technological and conceptual differences can be bridged either by means of standards or via approaches based on the Semantic Web. This documents deals with the issue of semantic interoperability of educational contents on the Web by considering the integration of learning standards, Semantic Web, and adaptive technologies to meet the requirements of learners. Discussion is made on the state of the art and the main challenges in this field, including metadata access and design issues relating to adaptive learning. Additionally, a way how to integrate several original approaches is proposed.

2.2.5 Privacy and Data Protection

Another important issue concerns privacy provision and data protection, which became the topic of D1.5. They form the basic requirements for corporate e-learning, especially when personalized systems are used that adapt to sensitive learner personal data. In this document we present important topics that need to be investigated before technology enhanced learning is introduced in corporate settings, e.g. legal requirements and threats to learners' personal

data, such as linkability of data, observability of data, identity disclosure, or data disclosure. Data protection technologies and privacy enhancing technologies, e.g. identity protectors, which should be integrated in learning solutions or that are missing in the current technology enhanced learning are identified, as well as the future research topics and IST projects that are currently trying to solve the problems. The main future topics relevant for technology enhanced learning in corporate environment are common to other types of e-work, i.e. identity management, personal data protection and digital rights management.

2.2.6 Authoring

D1.8 addressed a next key problem in this field – authoring methods of personalized workplace learning (elaborated into another journal paper). We surveyed the existing approaches for the personalization and adaptation of eLearning systems which are proposed by partners from the PROLEARN consortium. This document enables the comparison of various methods and techniques, and facilitates their integration or reuse within the Consortium and beyond. It offers a cohesive reference for other workpackages dealing with work processes and business models. The use of models as means for specification opens the possibilities to integrate the work with other workpackages which also focus on modeling but from other perspectives (e.g. WP4 focusing learning object metadata and querying).

2.2.7 Interfacing with Corporate Training Systems

As the widely used learning platforms do not support personalized adaptive learning sufficiently, D1.9 investigates how to interface adaptive solutions with existing corporate training systems. This means the following three steps have been performed: inventory of systems used by corporate partners, analysis thereof, and technology description; description of conceptual frameworks of interfacing; and selection of small subset for which (experimental) interfaces have been developed and evaluated.

2.2.8 SECI-based Framework

An important achievement (not only of WP1, but of the whole project) was development of a SECI-based framework for learning processes at work, presented in D1.10. This deliverable focuses on the link between individual and organizational learning based on the interaction processes at the workplace, and key implications for personal and organizational knowledge management as they relate to organizational performance. Taking input from the SECI-based survey in WP7 and building on the results from PROLEARN D5.3, which introduced the SECI process framework, we here modify the SECI model so that it better fits the observed interaction processes that go on between employees at the workplace. The aim is to capture the semantics of these interactions in an enriched process model, which allows for management to get a better view of those aspects of what is going on inside their organization as well as how their organization interacts with external stakeholders. The style of modelling introduced here could in fact be called “managerial modelling”. This deliverable informs D7.7 and relates to both D1.11 (with a focus on IMS Learning Design) and D6.7 (with a focus on informal learning, Web 2.0 and social software).

2.2.9 Integration with IMS Learning Design

D1.11 deals with standards and integration, especially with four topics: IMS Learning Design, Adaptation, Integration and Corporate Requirements. It attempts to emphasize the needed relationship among them in order to improve the personalized learning. Based on academic research, our findings take also into account the specific features of corporations. D1.11 is closely related to D1.10, where several taxonomies of learning processes and learning categories are presented, which are used in D1.11 to model adaptive learning processes with IMS-LD. In order to use adaptation in companies we take corporate requirements as a part of the deliverable and we develop a showcase of example Units of Learning that model real use cases based on corporate settings. In order to demonstrate the integration between IMS-LD, adaptive learning processes, the CopperCore Service Layer and a metadata language, we have developed an adaptive IMS-LD UoL with an integrated eGame externally modelled with <e-Adventure> and a bi-directional communication flow resulting in a personalized learning path based on two inputs: the previous knowledge and the performance of the learner.

All in all, these deliverables provide a spectrum of perspectives on the most important issues and challenges in personalized adaptive professional learning, which we have identified at the beginning of the project: learner modeling, interoperability, privacy, authoring, interfacing with LMS, modeling of learning processes, integration with standards. These issues have been discussed at our events and further elaborated in our publications. We are addressing them and other related issues in our current and future projects.

2.3 Selected Publications

Two PROLEARN WP1 deliverables, namely D1.2 and D1.8, have been elaborated into journal papers:

1. Aroyo, L., Dolog, P., Houben, G.-J., Kravcik, M., Naeve, A., Nilsson, M. & Wild, F. (2006). Interoperability in Personalized Adaptive Learning. *Educational Technology & Society*, 9 (2), 4-18. http://www.ifets.info/journals/9_2/2.pdf
2. Dolog, P., Kravcik, M., Cristea, A., Burgos, D., De Bra, P., Ceri, S., Houben, G.-J., Libbrecht, P., Matera, M., Melis, E., Nejdil, W., Specht, M., Stewart, C., Smits, D., Stash, N., & Tattersall, C. (2007). Specification, authoring and prototyping of personalized workplace learning solutions, *Int. J. of Learning Technology*, Vol. 3, No. 3, pp. 286-308. <http://hdl.handle.net/1820/1081>

Cooperation among PROLEARN core and associate partners (e.g. University Belgrade, Simon Fraser University Surrey, University of Nottingham, Athabasca University, Salzburg Research, University of Leeds, University of Cordoba, University of Jyväskylä) resulted into several relevant publications – conference papers, journal papers, and book chapters. In the following we list some of them.

Book Chapters:

1. Cristea, A. & Stewart, C. (2006). Automatic Authoring of Adaptive Educational Hypermedia, In ZongMin Ma (Ed.) *Web-based Intelligent E-Learning Systems: Technologies and Applications*, Information Science Publishing (IDEA group), 24-55

2. Cristea, A. & Stewart, C. (2006). Authoring of Adaptive Hypermedia, In G. D. Magoulas and S. Y. Chen (Eds.) *Advances in Web-Based Education: Personalized Learning Environments*, Information Science Publishing (IDEA group), 225-252
3. Damjanovic, V. & Kravcik, M. (2007). Using Emotional Intelligence in Personalized Adaptation. In Sugumaran, V. (Ed.) *Intelligent Information Technologies: Concepts, Methodologies, Tools, and Applications*, IGI Publishing, 1716-1742
4. Dolog P., Nejd, W. (2007). Semantic Web Technologies for the Adaptive Web. In P. Brusilovsky, A. Kobsa, and W. Nejd (eds.). *The Adaptive Web: Methods and Strategies for Web Personalization*. Springer Verlag, LNCS 4321, pages 697-719.
5. Houben, G.J.P.M., Aroyo, L.M., De Bra, P.M.E., & Dicheva, D. (2005). Adaptation engineering in adaptive concept-based systems. In S.Y. Chen & G.D. Magoulas (Eds.), *Adaptable and Adaptive Hypermedia Systems* (pp. 36-58). Idea Group/IRM Press.

Journal Papers:

1. Brown, E., Cristea, A., Stewart, C., Brailsford, T. (2005). Patterns in Authoring of Adaptive Educational Hypermedia: A Taxonomy of Learning Styles, International Peer-Reviewed On-line Journal "Education Technology and Society", Special Issue on Authoring of Adaptive Educational Hypermedia, July 2005 (Volume 8, Issue 3).
2. Stefano Ceri, Peter Dolog, Maristella Matera, and Wolfgang Nejd (2005). Adding Client-Side Adaptation to the Conceptual Design of e-Learning Web Applications. *Journal of Web Engineering*, 4(1):21-37.
3. Cristea, A., Smits, D., de Bra, P. (2007). Towards a generic adaptive hypermedia platform: a conversion case study. *Journal of Digital Information (JoDI)*, Special Issue on Personalisation of Computing & Services, Vol 8, No 3.
4. Cristea, A. & Stewart, C., Brailsford, T., Cristea, P. (2007). Adaptive Hypermedia System Interoperability: a 'real world' evaluation. *Journal of Digital Information (JoDI)*, Special Issue on Personalisation of Computing & Services, Vol 8, No 3.
5. De Bra, P., Stash, N., Smits, D., Romero, C., Ventura, S. (2007). Authoring and Management Tools for Adaptive Educational Hypermedia Systems: The AHA! Case Study, in: *Studies in Computational Intelligence (SCI)* nr. 62, pp. 285-308, Springer Verlag.
6. Dolog, P., Simon, B., Nejd, W., Klobucar, T. (2008). Personalizing Access to Learning Networks. *ACM Transactions on Internet Technology*, Vol. 8, No. 2.
7. Hendrix, M., Cristea, A., Nejd, W. (2007). Authoring adaptive educational hypermedia on the semantic desktop. *International Journal of Learning Technology*, Special Issue on Authoring of Adaptive and Adaptable Hypermedia, Vol 3, Issue 3.
8. Kravčik, M. & Gašević, D. (2007). Leveraging the Semantic Web for Adaptive Education. *Journal of Interactive Media in Education (Adaptation and IMS Learning Design)*. Special Issue, ed. D. Burgos).
9. Muntean, C. H., Muntean, G.-M., McManis, J., Cristea, A. (2007). Quality of Experience-LAOS: create once, use many, use anywhere. *International Journal of Learning*

Technology, Special Issue on Authoring of Adaptive and Adaptable Hypermedia, Vol 3, Issue 3.

10. Romero, C., Ventura, S, De Bra, P. (2004). Knowledge Discovery with Genetic Programming for Providing Feedback to Courseware Authors, *Journal on User Modeling and User-Adapted Interaction*, Vol. 14, nr. 5, pp. 425-464.
11. Specht, M., Burgos, D. (2007). Modeling Adaptive Educational Methods with IMS Learning Design. *Journal of Interactive Media in Education (Adaptation and IMS Learning Design. Special Issue, ed. Daniel Burgos)*
12. Stash, N., Cristea, A.I., De Bra, P. (2007). Adaptation languages as vehicles of explicit intelligence in Adaptive Hypermedia, In *International Journal on Continuing Engineering Education and Life-Long Learning*, vol. 17, nr 4/5, pp. 319-336, InderScience.

Conference Papers:

1. Damjanovic, V., Kravcik, M., Devedzic, V. (2005). eQ: An Adaptive Educational Hypermedia-based BDI Agent System for the Semantic Web. In D. G. Sampson & P. Goodyear (Eds.) *Proc. of the ICAIT 2005 Conference*, Kaohsiung.
2. Damjanovic, V., Kravcik, M., Gasevic, D. (2005). eQ Through the FOSP Method. In P. Kommers & G. Richards (Eds.) *Proceedings of World Conference on Educational Multimedia, Hypermedia and Telecommunications 2005* (pp. 3080-3087). Chesapeake, VA: AACE.
3. Lai-Chong Law, E., Klobučar, T., Pipan, M. (2006). User effect in evaluating personalized information retrieval systems. In: Nejdil, W. (ur.), Tochtermann, K. (ur.). *Innovative approaches for learning and knowledge sharing: first European Conference on Technology Enhanced Learning, EC-TEL 2006*, Springer, 257-271.
4. Lai-Chong Law, E., Klobučar, T., Pipan, M. (2006). Analysis of user attitude and behaviour in evaluating a personalized search engine. In: ECCE 13, 13th European Conference on Cognitive Ergonomics. *Trust and control in complex socio-technical systems*. Zurich: ETH, 1-9.
5. Romero, C., Ventura, S., Hervá C., De Bra, P.M.E. (2006). An authoring tool for building both mobile adaptable tests and web-based adaptive or classic tests. In V. Wade, H. Ashman, & B. Smyth (Eds.), *Adaptive Hypermedia and Adaptive Web-Based Systems (Proceedings 4th International Conference, AH 2006, Dublin, Ireland, June 21-23, 2006)*, LNCS 4018 (pp. 203-212). Berlin: Springer-Verlag.
6. Romero, C., Ventura, S., Delgado, J.A., De Bra, P. (2007). Personalized Links Recommendation Based on Data Mining. In *Adaptive Educational Hypermedia Systems, to appear in: Proceedings of the second European Conference on Technology Enhanced Learning, EC-TEL 2007*, Springer LNCS, Crete.

2.4 Community of Practice about Adaptive Learning and IMS Learning Design

In PROLEARN, within WP1, we have focused on building a community of practice or social learning network via face-to-face events (ADALE workshops) and collaborative work (JIME, EGAEL journals). Specifically, we concentrated our efforts on building a thematic community of practice about Adaptive Learning and IMS Learning Design with four different branches:

- Online participation via forums
- E-mail exchange with researchers
- Face-to-face workshops
- A common effort on publishing a special issue on the topic

At <http://imsld.learningnetworks.org>, we have built an online community on the topic that has reached an intensive level of activity. Two factors contribute to this activity: 1) an active promotion to a selected group of qualified users who, in turn, have a good promotional skill. This makes that our initial seed of members has been expanded and has made a second, wider seed of active network users; and 2) a very specific goal, a straight and hot research topic. This makes that qualified members working on a specific topic find support each other while discussing and progressing on their work. The following picture shows a snapshot on the activity carried out right before (period A), during (period B) and right after (period C) June-July 2006, where the ADALE workshop series took place.

In parallel, it is a fact that researchers also lean on peer private relationships to improve and facilitate their work. Email exchange is a part of the social virtual network and it becomes a very difficult fact to measure. The invisible college that the scientist Robert Boyle built in XVII Century and which would become the Royal British Society, usually considered as the oldest scientific society in the World, is a burning issue nowadays still thanks to email and other communication ways.

The activity turned higher when the two face-to-face events took place at Adaptive Hypermedia 2006 (<http://www.open.ou.nl/mkv/ADALE.html>) and ICALT 2006 Conferences (Figure 1). The ADALE workshop series become an inflexion point to establish a real working network on the topic. Although lurking is always a feature in groups, these workshops bring upfront a real interest from a huge amount of individuals. The goal of the ADALE workshop series was to discuss how adaptive learning processes, learning design, and workplace processes interact with each other to provide adaptive personalized learning. The adaptivity based on a user profile is naturally suited for workplace learning due to its learner and context centric notion which is apparent in adaptive personalized systems for learning. However, the knowledge representation and focus of specification should be shifted more towards workplace activities and processes. IMS Learning Design is a promising approach for the standard based integration of learning activities, resources and learning networks, which is activity centred. However, integration of the IMS LD with more knowledge centric approaches, business process analysis, and specification approaches used in optimization of enterprise performance are needed. Therefore, the AH workshop session was especially interested in how adaptive

hypermedia and adaptive web techniques can be helpful in conjunction with IMS LD to improve workplace learning. Here are some of the current problems we identified at our workshops:

- IMS-LD can represent some adaptation methods, but not all of them
- Specification of concrete learning design instances is usually context dependent and does not support reusability very well
- Representation of various types of knowledge and their interaction to assist authors and to generate concrete instances dynamically
- Interoperability demands – between systems & between different models/layers
- Learning standards are not harmonized – Semantic Web is used as mediator
- Authoring of learning design and adaptation strategies

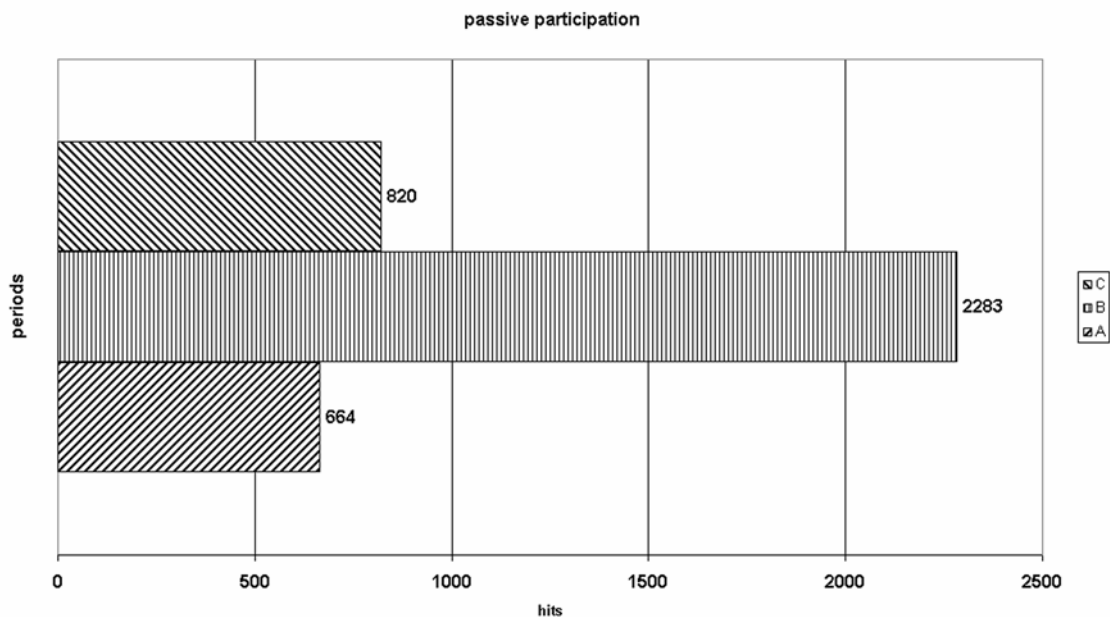

Figure 1. Forum based activity on Adaptive Learning and IMS Learning Design

In addition, WP1 organized a workshop at the University of Salamanca, Spain (May 29th-31st, 2006) on adaptive learning and blended learning. 32 teachers modelled actual Adaptive Learning scenarios with IMS Learning Design and Moodle (accessible at <http://imsld.learningnetworks.org/course/view.php?id=44>).

All the three branches (i.e., a forum-based activity, email exchange and face-to-face workshops) seeded a new initiative: a common effort to publish a special issue on Adaptive Learning and IMS Learning Design that became true in the Journal of Interactive Media in Education (JIME) in early 2007 (accessible at <http://jime.open.ac.uk/2007/01>). After a successful call and an exhaustive selection, seven papers were published, meaning a milestone on this research topic for the overall community.

Along with these activities, we have encouraged a new approach on Adaptive Learning and IMS Learning Design as a part of the EGAEL initiative (<http://www.open.ou.nl/dbu/egael2007>), a set of 1 face-to-face workshop (ISAGA 2007) and 2 special issues (Computers in Human Behavior, Simulation & Gaming) focused on Adaptive Learning and eGames. These activities are not a new track started in WP1. Following the EU Commission's advice we did not start a new research line in PROLEARN focused on games. However, we made a few specific and strategic contributions to this EGAEL2007 set of activities (created and fostered by The Open University of The Netherlands), since eGames become one of the multiple approaches to the ongoing research in Adaptive Learning and IMS Learning Design. In concrete, there are three different papers (one per track) addressing this issue (full reference list in previous sections of this deliverable).

2.5 Transfer of Tacit Knowledge

In the second half of the project there was an interesting move of people between PROLEARN partners, including associate partners. The project has spread its message and expanded the TEL community by means of people changing jobs. From the people working in WP1 several key persons moved: Marcus Specht and Milos Kravcik from FHG to OUNL, Lora Aroyo from TU/e to the Free University in Amsterdam, Geert-Jan Houben from TU/e to the Free University in Brussels, Alexandra Cristea from TU/e to the University of Warwick, Peter Dolog from L3S to Aalborg, Daniel Burgos from OUNL to ATOS Origin. This demonstrates intensive transfer of tacit knowledge between PROLEARN partners.

3 PROLEARN Related Contributions in Personalized Adaptive Learning

This paragraph introduces key concepts and other projects related to personalized adaptive and professional learning. As presented in the previous paragraph, in PROLEARN significant work was done in WP1 to come up with good overviews of the field and requirements for the next generation of e-learning environments, which has then led to new projects that are actually going to realize these requirements in new systems and applications. The EC is currently funding several important projects in the area of professional and personalized adaptive learning, each investigating this field from its own perspective, but together forming a strong synergetic effect. Here are several of their emphases:

- Personal competence management (TENCompetence)
- Personal learning and work environment (APOSDLE)
- Process oriented learning (PROLIX)
- Project centred learning (COOPER)
- Semantic web learning services (LUISA)
- Self-organized learning (iCamp)
- Intelligent cognitive-based open learning (iClass)
- Generating metadata for content enrichment (MACE, MELT)
- Adaptive learning spaces (ALS)

Most of the projects in the area of technology enhanced learning, which focus on professional learning, are grouped in the Professional Learning Cluster PRO-LC (<http://www.professional-learning-cluster.org/>) that was established by PROLEARN. Several currently running projects were initiated by PROLEARN partners during the lifetime of this Network of Excellence. In the following we present some of them and other efforts of PROLEARN core and associate partners.

3.1 *Personal Learning Environment Framework*

Personalized learning, informal learning and lifelong learning have become crucial challenges since they represent how learning in actual world happens. People are unique and everyone has her own learning goal and way of achieving it. Most learning today is informal. Cross (2003) states that at work we learn more in the break room than in the classroom. We discover how to do our jobs through informal learning – observing others, asking the person in the next cubicle, calling the help desk, trial-and-error, and simply working with people in the know. Formal learning is the source of only 10% to 20% of what we learn at work. People learn throughout their life and would not stop learning even after they graduated from formal education institutions.

Virtual Learning Environments (VLEs) as the traditional implementation of e-Learning failed to address these challenges. Therefore, a new solution is needed. Personal Learning Environment

(PLE), then, emerges as a new solution to achieve the challenges of personalized, informal, and lifelong learning. In contrast to VLEs, PLEs have the following characteristics:

- Symmetric relationship: Any learner should be able to both consume and publish resources using a service. No restriction imposes on a learner with a passive role, i.e. who only consumes resources (Wilson et al., 2007).
- Individualized context: A learner can reorganize the information within the contexts as she can see it in various ways and chooses suitable positioning tools (Wilson et al., 2007). PLEs can be customized and personalized to the needs and preferences of the learner.
- Social aspect: Learning is not only personal, but also social. PLEs not only provide personal spaces, which belong to and are controlled by the user, but also require a social context by offering means to connect with other personal spaces for effective knowledge sharing and collaborative knowledge creation (Chatti et al., 2007). PLEs can be connected to form a dynamic learning community.
- Bottom-up approach: A learner is not forced to use any tools or services provided by PLEs. PLEs let the learner choose any tools she deems fit to support her learning.
- Personalization and learner-centric: PLEs conform to the idea of personalization which is providing the learner with a myriad of services and handing over control to her to select and use the services in the way she deems fit (Chatti et al., 2007). Consequently, PLEs put learner at the center of learning and give her the control to decide how to achieve her learning goal.
- Personal and global scope: PLEs not only operate at the personal level in that they coordinate services and information that are related directly to user and owner. They also can be considered global in scope, as the range of services, they can potentially coordinate, is not bounded within any particular organization (Wilson et al., 2007).
- Knowledge-pull: Using PLEs, a learner can create an environment where she can pull knowledge that meets her particular needs from a wide array of high-value knowledge sources such as multimedia information repositories, communities, and experts.
- Lifelong learning and informal learning support: Since PLE is under the control of the learner, she can create a learning environment which not only supports her formal education but also allows her to explore other knowledge sources. Her learning will not stop even if she graduates from her formal education institution.
- E-Portfolio support: Using a PLE, a learner can create her own profile, education experience, skills, etc. which in turn might become her e-Portfolio.

Learning is an individual activity and every learner has her own learning goals. To achieve those goals, the learner might utilize the tools and services she deems fit.

However, even though the learning goals might be the same, the tools and services that are utilized might be different from one learner to the other. Consequently, these tools and services will shape unique PLEs for each learner. Recognizing the heterogeneity of PLEs, a framework which supports the creation of PLEs should be provided.

The concepts discussed above have been applied in the design of the Personal Learning Environment Framework (PLEF) – a framework which has been developed at RWTH Aachen University, Germany, with active support from the Open University at Heerlen, Netherlands in the framework of the PROLEARN project. PLEF provides the learner with ability to incorporate myriad of tools and services; and ability to determine and use the tools and services the way she deems fit to create her own PLE, adapted to her own situation and needs. PLEF also offers

means to connect with other personal spaces, so that users can engage in knowledge sharing and collaborative knowledge creation.

PLEF incorporates various Web 2.0 concepts and technologies. The web as platform, mashup of services, widely use of widgets, content aggregation, opened identity, small pieces loosely joined Web and rich user experience are the concepts which build up PLEF. Web 2.0 technologies, such as, RSS, openID and social tagging have been adopted as the basis to develop PLEF. PLEF has been developed using Java language under JEE technologies together with Ajax to ensure rich user experience.

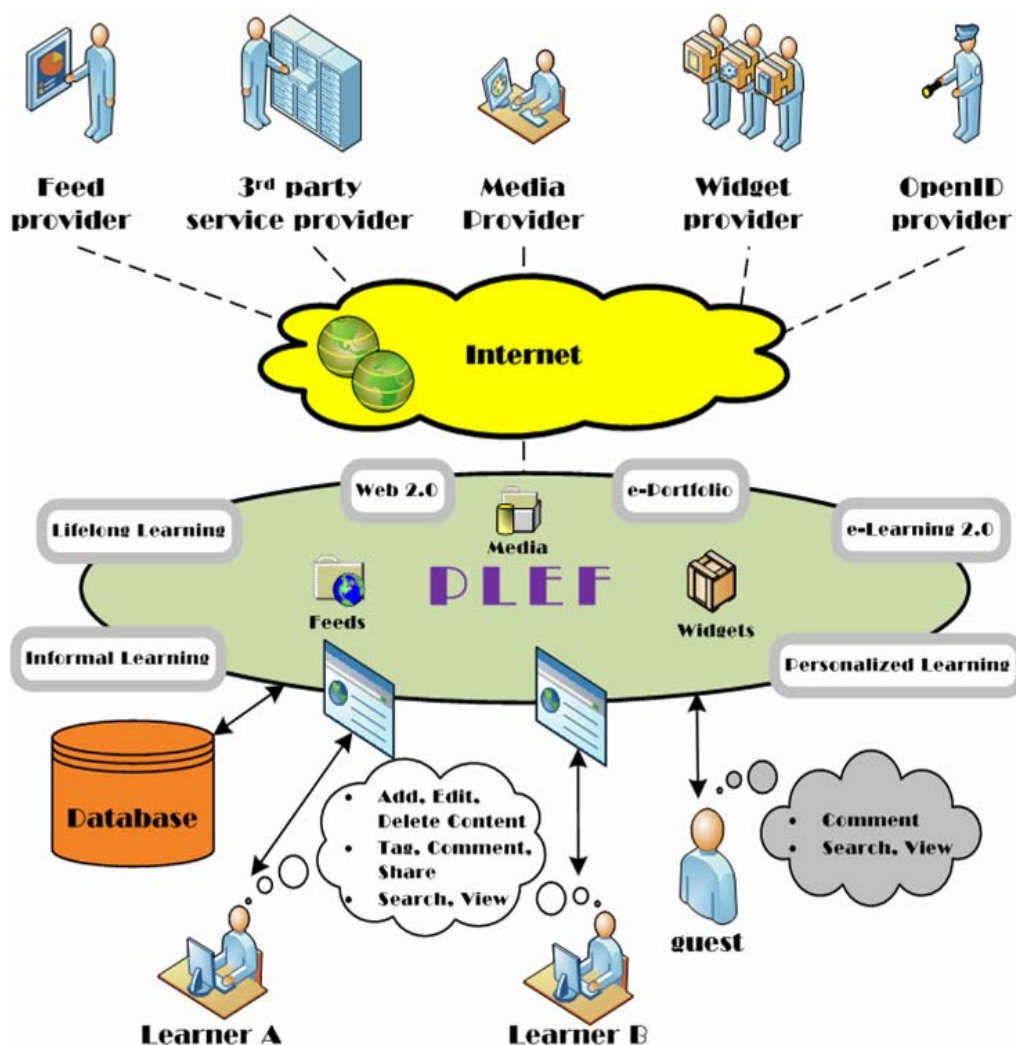

Figure 2. Abstract View of PLEF.

PLEF has been developed to fulfil the following requirements (Figure 2):

- Web browser platform: With web browser as the platform, the independence of operation system can be assured. This also enables PLEF to aggregate and integrate third-party services.
- Aggregation: PLEF allows a learner to aggregate her learning artefacts which currently encompass feeds, widgets and media (e.g. text, image, and link list).

- Theme Personalization: PLEF allows the learner to determine the theme of her PLE. This comprises the settings of page layout, layout of elements for each page and use of colour for pages and elements.
- Social features: PLEF provides several social features such as tagging, commenting, and sharing. Tagging allows a learner to define tags for every element of her PLE. Commenting and sharing are intended to serve the purpose of providing means to connect with other learners for knowledge sharing and collaborative knowledge creation. While commenting allows a learner to give comments to public elements of other learners' PLEs, sharing allows a learner to notify other learners of a specific element of her PLE. Responding to sharing notification, the notified learners can add the shared element to their own PLEs.
- Ease of use: PLEF provides rich experience with AJAX support. A learner is able to copy&paste and drag&drop elements to personalize and manage her PLE with minimum effort.

3.2 Adaptive Learning Spaces

Adaptive Learning Spaces (ALS, <http://www.als-project.org/>) is a project initiated by TU/e and Warwick, which is centered on adding Adaptation to Collaborative Learning Spaces. Its aim is to provide the technological means through which lack of (or limited amounts of) face-to-face contact between instructors and learners, as well as amongst learners can be partially compensated for. To achieve this, ALS will work towards: (a) widening the range of, as well as increasing the amount of, guidance and support that ODL systems can provide to learners and instructors, and (b) providing novel means to support the social cohesion of groups of learners, as well as the engagement of their members in collaborative / team tasks and processes.

This will be achieved by developing, field-testing and making openly available a software infrastructure that builds upon the state-of-the-art in the fields of e-learning and adaptive hypermedia systems, to support the creation of active, personalized learning spaces, that will have a clear focus on learning activities, treating learners as active members of, and contributors to, their learning environments, rather than as passive recipients of their contents. The project's main outputs will include the software technologies developed, as well as a series of 'Best Practices' reports that will accumulate the project's acquired knowledge and experience in integrating these technologies into existing ODL and blended learning settings.

3.3 Supporting Self-Directed Learning in Distributed Web-Environments

Within the ICAMP project, facilitators and learners are gathered in one virtual common space. This space does not consist of a single software system, but is composed out various interoperable web applications. Each element of this patchwork of open-source solutions and the entire space are compliant with an innovative pedagogical model built upon a social-constructivist approach. This pedagogical model encompasses social networking, scaffolding for self-directed learning, incentives, and cross-cultural collaboration aspects.

Other than in traditional domain-specific learning designs, ICAMP tackles a domain-independent problem: How should web-based tools (with the help of human facilitators) scaffold their users in acquiring competencies in traditional 'soft' competence areas. Consequently, the

solution differs as well: instead of learning design, ICAMP dedicates itself to learning environment design (Wild, 2007; Fiedler & Pata, 2007). Learning models are being constructed that enable learners as well as facilitators to build up and individualise their own web-based personal learning environment from a pre-defined and evaluated set of building blocks. The initialisation and the refinement of the adaptation model are shifted from system architects and instructors to learners and their facilitators.

The approach chosen within ICAMP therefore substantially differs. Run-time and storage interface more closely; adaptation becomes more scrutable (Kay, 2006) as it is scripted by user-driven instruction. When comparing **Error! Reference source not found.** and **Error! Reference source not found.**, this difference becomes most obvious when looking at rendering services: in the model sketched in Aroyo et al. (2007), a rendering service resides in the run-time & presentation specification layer on top of the adaptation and instruction layer, whereas in the case of the levels of interoperability depicted in Wild (2007), the rendering service is called from the higher-level presentation layer handing over the adaptation and instruction rules that have been authored by the users to produce the desired subordinate page of their personal learning environments.

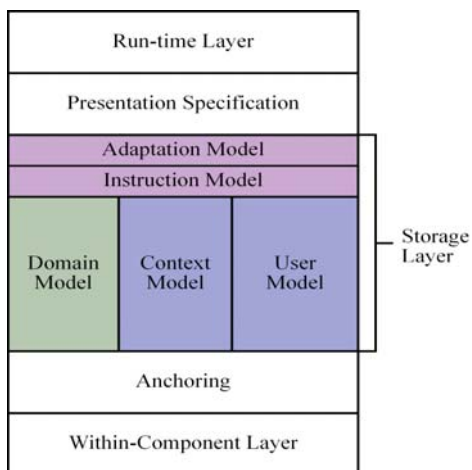

Figure 3. Enhanced Adaptive Hypermedia Model (Aroyo et al., 2006).

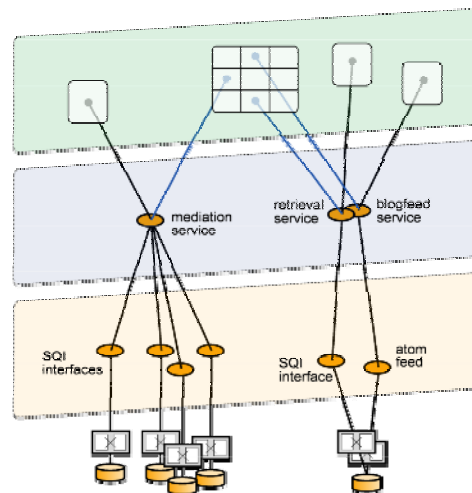

Figure 4. ICAMP Levels of Integration (Wild, 2007).

Both, adaptation rules and instructions are specified in a domain-specific language called 'learner interaction scripting language' (LISL) in order to allow learners to mash-up a highly individualised web-application to support the activities they pursue in the current learning situation – they, so to say, construct a particular view in their personal learning environment. By binding actions and activities to particular output literals and to specific building blocks, a semantic model is constructed that can easily be communicated and inspected. Future analysis from tracing learner interactions in such a web-based, mash-up personal learning environment (MUPPLEs) is expected to bring more insight into how learners act.

As highlighted with a few lines of code in Figure 5, this natural-like language is capable to support three important aspects of users interacting with the learning environment: First of all, this scripting language can be used to calculate the semantic model for recommending certain

tools for given educational scenarios. This calculation is based on define, require and recommend-statements in the source code.

```

lisl> define [an] activity "getting to know each other"
lisl> define [...] action [named] "compose"
lisl> add action "compose" to activity "getting to know each other"
lisl> define tool "xowiki" [with] url http://xowiki.icamp.eu
lisl> require tool "xowiki" [for] action "compose"
lisl> start activity "getting to know each other"
lisl> compose "self-description" using tool "xowiki"
lisl> define action "share"
lisl> add action "share" to activity "getting to know each other"
lisl> define tool "wordpress" url http://wordpress.icamp.eu
lisl> share "self-description" using tools "xowiki" [and] "wordpress"

```

Figure 5. Exemplary LISL code.

Secondly, learners can control the web-application mash-ups, and therefore also the adaptation process, using LISL commands. Although most interactions – like closing, maximizing or minimizing a window – can be achieved via user interface elements (Figure 6), it is possible to perform these operations with LISL code. In addition, a user can also define own commands and start these new actions as step of an activity. Thirdly, the usage of this scripting language also allows an extensively logging of learner interaction with the ICAMP space, i.e. also the interactions with user interface elements. Thus, the underlying semantic model can be refined on the basis of this logging information.

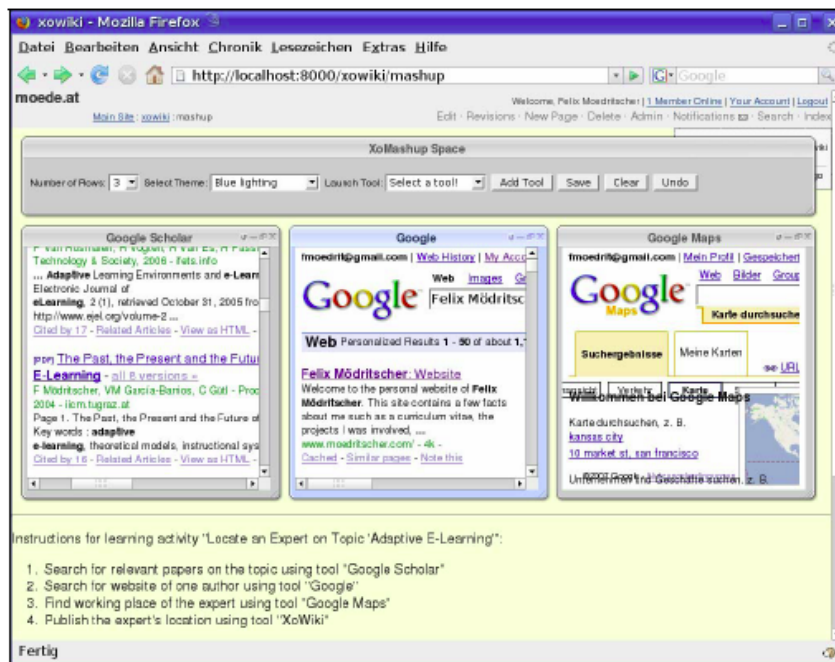

Figure 6. Example MUPPLE page.

Overall, the MUPPLE comprises a PAL approach in terms of recommending tool mashups for certain learning activities (instructional model), analysing learner interactions and refining the

recommendation rules (adaptation model). Further, the adaptation process is considered to be scrutable for and controllable by learners.

3.4 Personal Competence Management

Knowledge society demands continuous competence development and management at the individual-, group- and organizational level. These levels represent distinct fields with their own approaches and tooling, but integrated support for informal and formal learning is missing. The TENCompetence project (<http://www.tencompetence.org>) aims at building a technical and organizational infrastructure for lifelong competence development. The TENCompetence infrastructure will be based on Open Source Software (OSS) and Open Standards. OSS services can be replaced by commercial ones and this infrastructure should be self-sustainable after the project period. A network of core and associate partners will provide commercial and non-commercial services using this infrastructure.

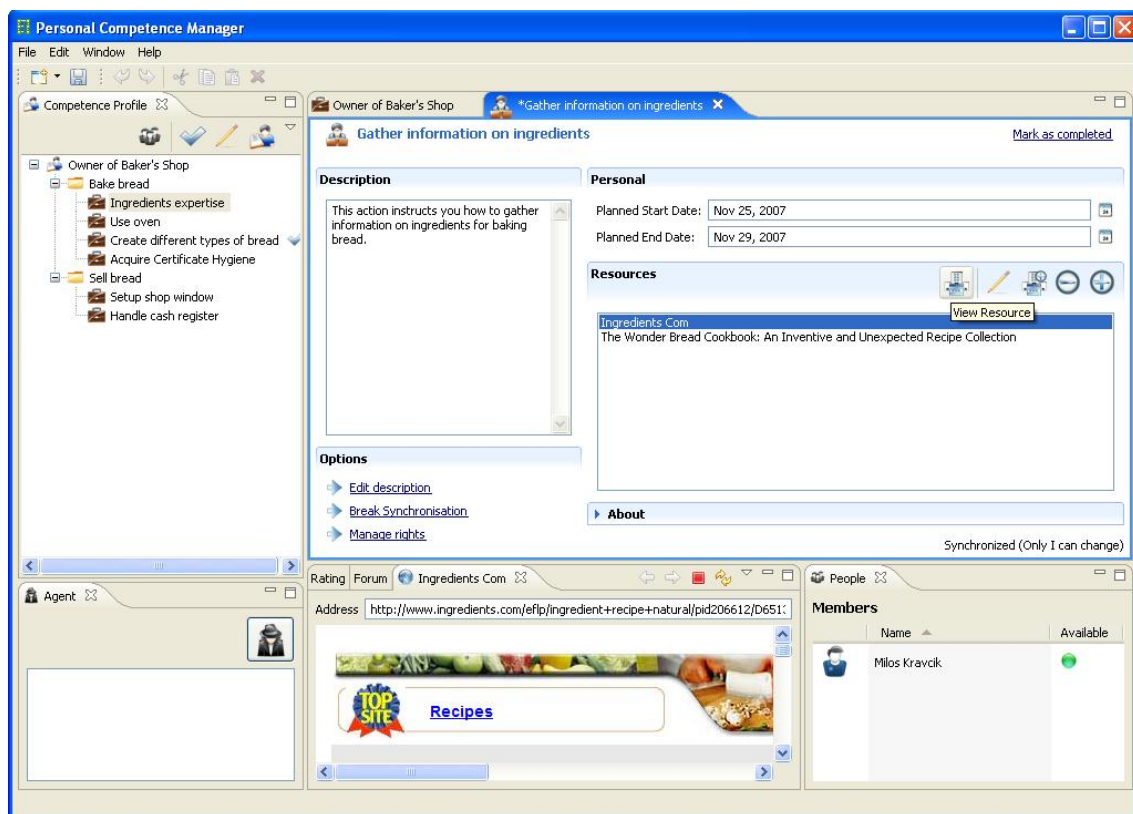

Figure 7. TENCompetence Personal Competence Manager.

The TENCompetence training approach is based on competence mapping and gap analysis. In addition to the 'demand-driven' approach in identifying training needs, TENCompetence principles and tools will be applied to assess competence and define competence gaps. Computer supported services will become available for competence definition, positioning, navigation, and recommending. Together these integrated services will constitute the Personal Competence Manager (PCM, Figure 7). The PCM data structure forms a set of directed acyclic graphs (one per community) with the following layers:

- Communities
- Competence profiles
- Competences
- Competence development plans
- Actions
- Resources

3.5 Semantic Web Services for Learning

Recent efforts in the area of learning technology have resulted in a considerable improvement in the interoperability of learning resources across different Learning Management Systems (LMS) and Learning Object Repositories (LOR). The central paradigm of such reuse-oriented technology is the notion of learning objects as digital reusable pieces of learning activities or contents. Semantic Web technology is able to provide the required computational semantics for the automation of tasks related to learning objects as selection or composition. Within this context, the project LUISA (Learning Content Management System Using Innovative Semantic Web Services Architecture: www.luisa-project.eu) addresses the development of a reference semantic architecture for the major challenges in the search, interchange and delivery of learning objects in a service-oriented context. Its mission is that of exploiting the advantages of a Semantic Web Service Architecture to make richer and more flexible the processes of query and specification of learning needs in the context of Learning Management Systems and Learning Object Repositories.

LUISA aims to match learning needs and learning objects (resources) through a competency-gap driven approach. By introducing *Learning Process Modules* (LPMs), which provide the “missing context” for learning resources, competency gaps can be mapped to pre- and post-requisite competency gaps. Since individual competencies are refined and developed by learning, they can be considered as input- and output learning resources to learning processes.

In fact, each *Learning Process Module* (LPM) can be considered as filling a *Real Competency Gap* (RCG), which is the difference between the *Input Competency* (IC), i.e., what the learner knows before entering the LPM, and the *Output Competency* (OC), i.e., what (s)he knows after having passed through it. The *Formal Competency Gap* (FCG) is the difference (as specified e.g., in a course manual) between the *Pre-Requisite Competency* (PreRC), which is required to enter the LPM, and the *Post-Requisite Competency* (PostRC), which is the competency that the LPM aims to provide for learners that fulfil its corresponding PreRC.

A *Forward Competency Gap* (FCG) is a difference between what the learner knows and what (s)he plans to know, while a *Backward Competency Gap* (BCG) is a difference between what the learner knows and what (s)he should have known. Hence, with respect to an LPM, a BCG is identical to a PreCG. In the EADS/Airbus (industrial) use case of LUISA, the difference between an employee’s *Personal Profile* and her/his *Present Position Profile* is her/his BCG. The difference between the employee’s *Personal Profile* and her/his *Desired Position Profile* is her/his FCG.

In general, FCGs are more associated with strategic learning needs (what a company needs to learn in order to stay in business), while BCGs are more associated with operational learning needs (what a company needs to know in order to deliver in its present undertakings). BCGs

often appear because employees leave the company and have to be replaced by others who do not quite know what they (ideally) should have known in order to serve as good replacements. See our D1.10 for more information on this distinction.

A Learning Process (LP) can be modelled as a chain of successive LPMs, where the PostRC of the LPM_k is identified with the PreRC of the LPM_{k+1}. In this way, the large learning goal of the entire LP can be broken down into a sequence of smaller learning (sub)goals for each LPM. This map well to the concepts of goals and sub-goals in WSMO (Web Services Modeling Ontology), where there are goal-goal-mediators that can be used to mediate between goals.

3.6 Learning Object Context Ontology

An important problem in Web-based education is that of generating meaningful *feedback* for learning content authors and teachers from the students that took Web-based courses. Typically, such a feedback is acquired only through end-term questionnaires that give some general insight into learners' satisfaction with the course, but tend to lack details needed to address anything other than coarse-grained problems. For example, they do not point out the pieces of the learning content that the learners had problems to grasp. Even when the learners are willing to give as much feedback as possible, their answers are limited with questions that only cover high-level details of the whole course. However, causes of potential problems are always context-dependent and can only be revealed if one can track the learning process and capture links between learning activities (e.g., reading or discussing), learning content, learning outcomes (e.g. quizzes), and the learners themselves. Having such links captured, one can generate more fine grained feedback. For example, for students who performed poorly on quizzes, one can identify the learning paths they followed, to whom and about what they talked in chat rooms or discussion forums and how their messages are related to the learning content being taught.

LOCO-Analyst is a tool developed by several PROLEARN associate partners (like University Belgrade, Athabasca University, Simon Fraser University) for capturing such a feedback from learners' activities automatically (Jovanović et al., 2007). The tool implements the *Learning Object Context Ontology (LOCO) framework* that is based on the notion of *learning object context*. In brief, LOCO formalizes the notion of learning object context as a complex interplay of learning activities, learning objects, and learners. LOCO includes a number of ontologies related to online learning: domain ontologies, user model ontology, ontology of learning design, learning object context ontology (called LOCO-Cite ontology), content structure ontology, etc. These ontologies interrelate information about learning objects, learning activities and learners captured from various tools and services (e.g., learning content and metadata editors and LCMSs and their tools), as well as about products of learning activities (e.g., chat messages).

LOCO-Analyst is implemented as an extension of Reload Editor, the *defacto* standard content-packaging tool for SCORM content. The tool is already evaluated by using it to provide feedback to content authors based on learning tracking data extracted from the state-of-the-art LCMS *iHelp Courses* (Brooks et al., 2005). LOCO-Analyst is a classical 3-tier desktop application (Figure 8). The bottom layer incorporates the following data repositories:

- *LO Repository* – a repository of learning objects stored in the form of SCORM content

packages;

- *Repository of LOCs* – a semantic repository of learning object context data. The repository holds instances of the LOCO-Cite ontology. It is based on Sesame (<http://www.openrdf.org/>) - an open-source Java framework for storing, indexing and querying semantic data.
- *User Model Repository* – another Sesame-based semantic repository which stores user models (profiles) in accordance with the employed User Model ontology;
- *Feedback Repository* – a repository of generated feedback, stored there for a quick access. Due to the nature of the analyses it performs when generating feedback, LOCO-Analyst cannot instantly respond to the user's request for a feedback. Instead, these analyses are performed in the background and the results are stored in this repository (*i.e.* the repository caches analysis results). The user is notified when the requested feedback becomes available.
- *Repository of domain ontologies* – a repository which hosts domain ontologies, *i.e.* ontologies formally representing the subject domain of the learning content (*i.e.*, courses) stored in the *LO Repository*. All domain ontologies are uniquely structured.

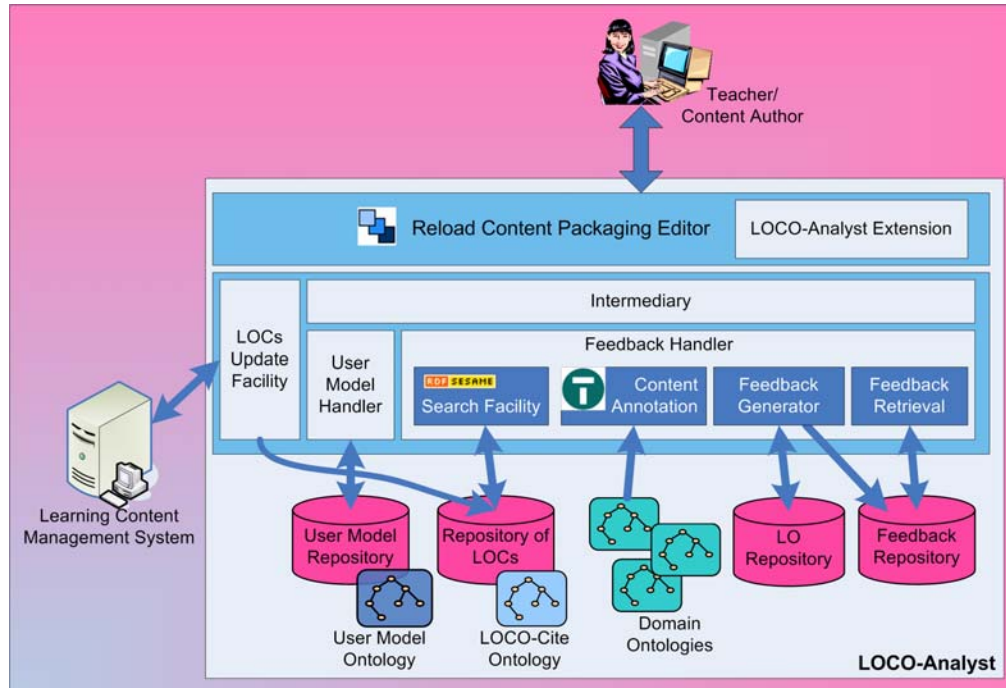

Figure 8. The architecture of LOCO-Analyst.

The heart of the system is the application logic encapsulated in the middle layer of the system architecture. It includes four well-decoupled modules: Feedback Handler, User Model Handler, Intermediary and LOCs Update Facility. The Feedback Handler module is the most complex of the four. It includes the following components:

- *LOCs Search Facility* – performs search and retrieval of learning objects context data from the *Repository of LOCs*. It uses *SeRQL*, the RDF query and transformation language for querying the repository and retrieval of semantic data.

- *Content Annotation Facility* – performs semantic annotation (*i.e.* annotation with the terms from domain ontologies) of the content used/generated during the learning process. In particular, it semantically annotates not only lessons, but also messages exchanged in students' online interactions (*e.g.*, chat rooms and discussion forums). To perform semantic annotation, this component makes use of two cutting-edge Java frameworks, namely GATE and KIM. GATE (General Architecture for Text Engineering, <http://gate.ac.uk>) is an advanced open-source Java framework for text-mining, whereas KIM (<http://www.ontotext.com/kim/>) is a complex platform for knowledge and information management (we use only its semantic annotation capabilities).
- *Feedback Generator* – integrates the logic for generating feedback from learning object context data and annotated learning content. It depends on the previous two components, in terms that it uses their outputs as its input.
- *Feedback Retrieval Facility* – retrieves feedback previously generated and stored in the *Feedback Repository*. It does this in response to a user's request for a specific feedback.

User Model Handler handles all requests for accessing and/or updating the User Model Repository. It uses Sesame and SeRQL language for handling the ontological data in the repository. The Intermediary module serves as a mediator between the application layer and the user interface layer. It enables decoupling between the application logic and the user interface. The role of the LOCs Update Facility component is to occasionally 'refresh' the content of Repository of LOCs. In particular, this component takes the log data from a LCMS, transforms them into a set of instances of the LOCO-Cite ontology (*i.e.*, ontological representation of learning object context data), and stores the generated instances into the Repository of LOCs. This component is fairly autonomous; its functioning is independent from the other components of the system. It is set to perform automatic updates once in a month (shorter time periods are of almost no relevancy for the kind of analyses the system performs), but this can be easily reconfigured. Currently, this component knows how to map log files of the iHelp Courses LCMS into learning object context data (*i.e.* instances of the LOCO-Cite ontology), but it can be extended to provide support for log files of other LCMSs as well.

The top-most layer handles interactions between the system and a user. Since LOCO-Analysts is implemented as an extension of Reload Editor, teachers do not have to switch between two tools when doing revisions of their courses. After being provided with a feedback on a certain course/module and having recognized the parts that need to be modified, the teacher can do all required modifications in the same tool (Reload). Although we have extended the user interface of Reload Editor with a number of new frames and dialogs required for efficient interaction between a user and LOCO-Analyst, the look-and-feel and the interaction style of the user interface have essentially remained the same.

4 Trends in Personalized Adaptive Learning

This paragraph first describes some phenomena (the long tail, the wisdom of crowds) that have strong impact on the current society and learning as well. Then we outline our ideas how PROLEARN activities in this area should sustain via realization of new projects (in addition to the running ones) according to the requirements specified in WP1 during the lifetime of the project. These are articulated especially in the Roadmap Vision Statement 1 and in the

GRAPPLE Project. Our deliverables helped defining the GRAPPLE project that will implement and deploy the ideas for which WP1 has delivered the requirements and specifications.

4.1 The Snowflake Effect

There are numerous cases where we are used to being treated as snowflakes (The Snowflake Effect, 2007) – i.e. unique entities. Our message is that a personalized experience can now be provided for many more facets of our life. This requires no major breakthrough in technology, but can be realized with today’s tools. Indeed, we will illustrate this point with numerous examples that exist today – in that sense, “The future has already arrived. It’s just not evenly distributed yet.”

The central theme is that technology enables us to scale personalization up to a scale that was completely out of reach until recently: banks and hospitals can only provide a personal service at considerable cost. These days, automated social recommendation services, or sophisticated metadata matching algorithms can provide a similar service for music, literature, television, food, travel, clothes and most other interests you may have.

Not only have technological advances enabled the snowflake effect; they have also made the need for personalization stronger than ever. The evolution from an ‘economy of scarcity’ towards an ‘economy of abundance’ has created a ‘paradox of choice’.

For most of us, in most contexts, this means more freedom to get what we want, when we want it, as we want it. But most of us are also familiar with circumstances where this increased freedom leads to anxiety and fear of making the wrong choice – or just not the best choice.

Contrary to what some have suggested, we do not believe that the solution to this “embarrass du choix” should be less choice. That road leads us back to the past. Rather, the abundance of choice should be balanced by the snowflake effect, by reducing the choices we actually need to make in a conscious way. This can be achieved by filtering these options against our personal preferences and by dynamically responding to the context we find ourselves in.

4.2 The Long Tail

According to (Anderson, 2006) our culture and economy are increasingly moving from hits toward niches and demand must follow this new supply: “Our culture and economy are increasingly shifting away from a focus on a relatively small number of hits (mainstream products and markets) at the head of the demand curve, and moving toward a huge number of niches in the tail”. A Long Tail is just culture unfiltered by economic scarcity. The author identifies three forces representing a new set of opportunities in the Long Tail:

- Democratizing Production,
- Democratizing Distribution,
- Connecting Supply and Demand.

The first force is democratizing the tools of production. The distinction between "professional" producers and "amateurs" has blurred, as the tools of production and creativity has become cheap and ubiquitous. The second force is cutting the costs of consumption by democratizing distribution. "Aggregators" are a manifestation of this second force. The third force is connecting supply and demand, introducing consumers to these new and newly available goods and driving demand down the tail. Anderson stresses the need for "filters" that should help us find quality in the Long Tail. As he puts it "Amplified word of mouth is the manifestation of the third force of the Long Tail: tapping consumer sentiment to connect supply to demand. The first force, democratizing production, populates the Tail. The second force, democratizing distribution, makes it all available. But those two are not enough. It is not until this third force, which helps people find what they want in this new superabundance of variety, kicks in that the potential of the Long Tail marketplace is truly unleashed".

4.3 The Wisdom of Crowds

Another important phenomenon the modern information and communication technology can benefit of is the wisdom of crowds (Surowiecki, 2004). It is based on observations that when solving cognition, coordination, and cooperation problems requiring decision making, prediction, and estimation, especially if the solutions are fuzzy and less definitive, the many are smarter than the few. Under the right circumstances, groups are remarkably intelligent, and are often smarter than the smartest people in them. Even if most of the people within a group are not especially well-informed or rational, it can still reach a collectively wise decision. The author mentions four conditions that characterize wise crowds:

- Diversity of opinion (each person should have some private information, even if it is just an eccentric interpretation of the known facts),
- Independence (people's opinions are not determined by the opinions of those around them),
- Decentralization (people are able to specialize and draw on local knowledge),
- Aggregation (some mechanism exists for turning private judgments into a collective decision).

4.4 Research Challenges

As we mentioned earlier, the lack of reusability and interoperability is a major problem in personalized adaptive learning. This is known as "open corpus problem" dealing with applicability of adaptive hypermedia techniques in such contexts like the Web and educational repositories. *Open Corpus Adaptive Hypermedia System* (Brusilovsky & Henze, 2007) is defined as an adaptive hypermedia system which operates on an open corpus of documents, e.g. a set of documents that is not known at design time and, moreover, can constantly change and expand. This problem necessitates solutions on two different levels – reuse of content and reuse of adaptive functionality. While the first case deals with metadata standards and indexing of resources, the second one requires describing adaptive functionality in a system-independent manner. Interoperability demands can be recognized not only between various adaptive

systems, but also between their different layers (Kravcik & Gasevic, 2007). The existing solutions are not harmonized for a holistic approach. Standardized learning design enables certain interoperability between systems, but its reusability is limited. For the adaptation model standards are still missing. As the current standards themselves cannot fully realize interoperability in personalized adaptive learning, the Semantic Web is usually used as the mediator. Its layered architecture provides means for reasoning about the adaptation-specific information in a standardized but open environment. There are three main aspects for further research challenges in this area (Dolog & Nejd, 2007): knowledge representation (both procedural and propositional), technological (heterogeneity of information resource), and computational (performance of the reasoners). Further research is needed in these areas.

4.5 Roadmap Vision Statement 1

With WP12 we have closely cooperated on the development of the Vision Statement 1 (VS1): “Everyone (in the community of current, potential and future knowledge workers) should be able to learn anything at anytime at anyplace.” We have analyzed this vision statement, identified the gaps and a set of actions to overcome them. The aim is to create and deliver a personalized learning experience to everyone. The word “everyone” in the vision’s statement title and goals signifies that everyone should have the ability to learn anything where and when he wants. The following main goals were identified for VS1:

1. Provide the right learning experiences at the right time for the target person (which can be everyone)
2. Everyone should have access to all public learning materials at any time at any place

Our analysis is based on the fact that learning has a very personal view, such as personal development and competencies development in a short and long term perspective. Moreover, in many cases the learner is not aware of what he needs to learn to develop certain competencies. A negotiation mechanism for power alignment is needed (pull versus push). The goal of this statement is not only to create many choices but also help people decide what’s just right for them. The new mobility and ubiquity capabilities enabled by today’s technology have an impact on the ways people live, work, and learn. Open content exchanges and distribution channels for sharing content support reconciling supply and demand in the “knowledge marketplace”. They enable learning and content syndication by many different providers, including provision of value added services such as access to experts, communities of practice, experiences and consulting services. This type of knowledge syndication enables the creation of a big variety of choices. Self-organization and proactive control of learning in that sense becomes very important, supported by personalized learning environments where the importance of creating and maintaining various kinds of relationships is becoming paramount.

The gap was identified in from four different perspectives:

In the *business* area separation between work and not work is not clear today anymore, especially for knowledge workers. Learning tends to be transparently integrated into work processes, thus it needs to be ubiquitous and nomadic. Traditional educational institutions prevail and new appropriate business models for learning services are still missing, which is a major drawback nowadays.

The *technical* field witnesses the most rapid development, particularly of information and communication technology. Originally separated technologies are being integrated, combining various benefits. Mobile devices enable ubiquitous communication services and access to huge amount of information. Anyway, standards and specifications are not harmonized, what causes interoperability problems, for instance there is a need of interoperable learning repositories.

From the *socio-cultural* perspectives there are essential differences in the availability of the modern technology and services, as well as in digital literacy that is often missing. One sixth of the world population has access to the Internet and can benefit from its innovative services – information, publication, communication, and collaboration. A major issue of information overload has been addressed by effective information retrieval and recommendation services. Huge popularity of mobile communication devices shows a promising direction for development of learning services. Open content exchanges and distribution channels are crucial for integrative learning based on bottom-up approaches. The modern trends focus on individualized and personalized learning, as well as ambient and nomadic learning.

In the *political* sphere there is a demand to support new educational models and methodologies that are necessary for both formal and informal life-long learning.

Based on the identified gaps a set of recommended actions is derived for this vision statement. The aim is to create and deliver a personalized learning experience to everyone. Considering the above mentioned phenomena – the long tail and the wisdom of crowds, we formulated these actions:

A1. *“Aggregation of learning resources”*: establishing a public platform where people collect and share learning resources (or their references), annotate (metadata), evaluate, recommend, and discuss on them

A2. *“Production tools for learning resources”*: to simplify production of standardized (reusable, interoperable) learning material, including adaptive interactive components

A3. *“Contextual delivery of learning resources”*: filtering and semantic search based on various types of metadata, adaptive delivery (mobile, ubiquitous), both pull & push approaches

A4. *“Harmonization of learning standards”*: to achieve better interoperability of learning resources it is necessary to harmonize learning standards (and use semantic web as facilitator)

A5. *“Digital Identity Management”*: mechanisms to create the identity of individuals and organizations that can be used in learning networks are needed

A6. *“Business models for learning exchanges”*: to enable efficient sharing and exchange of learning resources feasible business models have to be developed. These models should support both open/free and commercial learning offerings.

4.6 GRAPPLE Project

The research and development issues identified in WP1 are being already addressed in various current projects and we have mentioned some of them in the paragraph 3. Also several new projects are already prepared, which will deal with these issues. Here we introduce at least one

of our steps in the previously outlined directions. The project GRAPPLE – Generic Responsive Adaptive Personalized Learning Environment is a 3-year STREP FP7 project (2008-2011), in which PROLEARN partners TU/e, OUNL, L3S, Warwick, DFKI, and IMC play a crucial role. Additionally, several other GRAPPLE partners are PROLEARN associate partners, e.g. the University of Lugano and the Vrije Universiteit Brussel. This is a very nice example of how the WP1 work that really kicked off at the Lugano workshop at ED-MEDIA 2004 has laid the basis for the fundamental ideas and consortium of GRAPPLE.

The GRAPPLE project aims at delivering to learners a technology-enhanced learning (TEL) environment that guides them through a life-long learning experience, automatically adapting to personal preferences, prior knowledge, skills and competences, learning goals and the personal or social context in which the learning takes place. The WP1 deliverables D1.1/2/3/4/6/9/11 provided most of the basis for the definition of GRAPPLE, which makes GRAPPLE a natural concretization of the work that PROLEARN has specified. To achieve this goal GRAPPLE will first of all develop the following:

- A common abstract description of desired adaptive behaviour, using *conceptual adaptation models* (or CAMs), and a “translation” to lower level adaptation rules that can be used by actual adaptation engines.
- Authoring tools to define CAMs, capturing relationships between concepts that are of a navigational and/or pedagogical nature, e.g. *prerequisite relationships*. In order to “package” a learning application consisting of domain-dependent information and CAMs extensions to standards will be proposed that can represent all required information to port learning applications between different *adaptive learning environments* (or ALEs).
- A *general purpose adaptation engine* that can adapt any (xml) information, either as part of a pipeline from source to user-interface, or as a stand-alone adaptive learning environment that performs adaptation and complete user-interface presentation.
- *User modelling* (or UM) *services* that keep track of each user’s learning process in order to provide input to the adaptation engine to base the adaptation on.
- A *distributed user modelling* (UM) *architecture* will be designed and developed to link different ALEs and UM services together, and to perform retrieval and reasoning over UM information coming from different services, as well as reason about where to send updates to a user model to.
- The adaptive functionality will be *integrated* in different existing *learning management systems*, either open source ones (Moodle, Claroline, Sakai) or proprietary systems aimed at corporate learning applications (realized by GRAPPLE’s industry partners).
- An *evaluation framework* will be set up and used extensively to evaluate the usability and effectiveness of adding adaptive behaviour to learning applications, in higher education and in corporate settings.
- Documentation and training material, mostly for *authors* of adaptive learning material, will be developed and used during training sessions for educators willing to introduce adaptive TEL in their organization and to participate in the GRAPPLE evaluation process.

5 Conclusion

In this deliverable we have summarized the work done in the WP1 Personalized Adaptive Learning during the lifetime of the PROLEARN project, attempted to map the current situation, and finally outlined future perspectives in this field. It is our belief that PROLEARN Network of Excellence helped in identifying the crucial issues in the field of personalized adaptive learning and in addressing them either directly in this project or via initiating new ones.

6 Acknowledgement

We want to express our acknowledgement to the EC for their support and to our reviewers for their valuable comments and suggestions in the PROLEARN project.

7 References

Anderson, C., (2006). *The Long Tail: Why the Future of Business is Selling Less of More*. Hyperion. [ISBN 1-4013-0237-8](#).

Aroyo, L., Dolog, P., Houben, G-J., Kravcik, M., Naeve, A., Nilsson, M. & Wild, F. (2006). Interoperability in Personalized Adaptive Learning. *Educational Technology & Society*, 9 (2), 4-18.

Brooks, C., Kettel, L., and Hansen, C. (2005). 'Building a Learning Object Content Management System,' *Proceedings of the 10th World Conference on E-Learning in Corporate, Government, Healthcare, and Higher Education*, Vancouver, Canada, pp. 2836–2843.

Brusilovsky P. & Henze, N. (2007). Open Corpus Adaptive Educational Hypermedia. In Peter Brusilovsky, Alfred Kobsa, and Wolfgang Nejdl (eds.). *The Adaptive Web: Methods and Strategies for Web Personalization*. Springer Verlag, LNCS 4321, pages 671-696.

Chatti, M.A., Jarke, M. and Frosch-Wilke, D., (2007). The future of e-Learning: a shift to knowledge networking and social software. *International Journal of Knowledge and Learning IJKL* 3(4).

Cross, J., (2003). Informal Learning – the other 80%. *Internet Time Group*.

Dolog P. & Nejdl, W. (2007). Semantic Web Technologies for the Adaptive Web. In P. Brusilovsky, A. Kobsa, & W. Nejdl (eds.). *The Adaptive Web: Methods and Strategies for Web Personalization*. Springer Verlag, LNCS 4321, pages 697-719.

Fiedler, S., Pata, K. (2007). Towards an Environment Design Model for iCamp Space, Deliverable 1.2, iCamp project, Vienna, Austria.

Jovanović, J., Gašević, D., Brooks, C., Devedžić, V., Hatala, M., Eap, T., Richards, G. (2007). Using Semantic Web Technologies to Analyze Learning Content, *IEEE Internet Computing*, Vol.11, No.5, pp. 45-53.

Kay, J. (2006). Scrutable Adaptation: Because We Can and Must, In: Wade, Ashman, Smyth (Eds.): *Adaptive Hypermedia and Adaptive Web-Based Systems*, Proceedings of the AH 2006, Springer, Berlin / Heidelberg, pp. 11-19.

Kravčák, M. & Gašević, D. (2007). Leveraging the Semantic Web for Adaptive Education. *Journal of Interactive Media in Education* (Adaptation and IMS Learning Design. Special Issue, ed. D. Burgos).

Surowiecki, J., (2004). *The Wisdom of Crowds: Why the Many Are Smarter Than the Few and How Collective Wisdom Shapes Business, Economies, Societies and Nations*. Little, Brown. ISBN 0-316-86173-1.

The Snowflake Effect. <http://ariadne.cs.kuleuven.be/mediawiki/index.php/SnowflakeEffectPaper>

Wild, F. (2007). An Interoperability Infrastructure for Distributed Feed Networks, Deliverable 3.3, iCamp Project, Vienna, Austria

Wilson, S., Liber, O., Johnson, M., Beauvoir, P., Sharples, P., and Milligan, C., (2007). Personal Learning Environments: Challenging the Dominant Design of Educational Systems. *Journal of e-Learning and Knowledge Society*, 2007(2).