



**HAL**  
open science

# Modelling of waste heat recovery for combined heat and power applications

Georges Descombes, Serge Boudigues

► **To cite this version:**

Georges Descombes, Serge Boudigues. Modelling of waste heat recovery for combined heat and power applications. Applied Thermal Engineering, 2009, 29 (13), pp.2610. 10.1016/j.applthermaleng.2008.09.019 . hal-00587603

**HAL Id: hal-00587603**

**<https://hal.science/hal-00587603>**

Submitted on 21 Apr 2011

**HAL** is a multi-disciplinary open access archive for the deposit and dissemination of scientific research documents, whether they are published or not. The documents may come from teaching and research institutions in France or abroad, or from public or private research centers.

L'archive ouverte pluridisciplinaire **HAL**, est destinée au dépôt et à la diffusion de documents scientifiques de niveau recherche, publiés ou non, émanant des établissements d'enseignement et de recherche français ou étrangers, des laboratoires publics ou privés.

## Accepted Manuscript

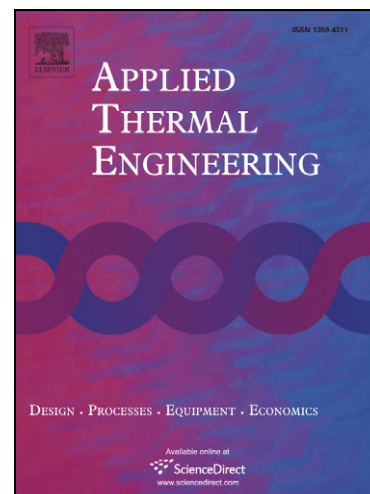
Modelling of waste heat recovery for combined heat and power applications

Georges Descombes, Serge Boudigues

PII: S1359-4311(08)00381-5  
DOI: [10.1016/j.applthermaleng.2008.09.019](https://doi.org/10.1016/j.applthermaleng.2008.09.019)  
Reference: ATE 2624

To appear in: *Applied Thermal Engineering*

Received Date: 15 January 2007  
Revised Date: 8 August 2008  
Accepted Date: 17 September 2008



Please cite this article as: G. Descombes, S. Boudigues, Modelling of waste heat recovery for combined heat and power applications, *Applied Thermal Engineering* (2008), doi: [10.1016/j.applthermaleng.2008.09.019](https://doi.org/10.1016/j.applthermaleng.2008.09.019)

This is a PDF file of an unedited manuscript that has been accepted for publication. As a service to our customers we are providing this early version of the manuscript. The manuscript will undergo copyediting, typesetting, and review of the resulting proof before it is published in its final form. Please note that during the production process errors may be discovered which could affect the content, and all legal disclaimers that apply to the journal pertain.

## Modelling of waste heat recovery for combined heat and power applications

Georges Descombes\* and Serge Boudigues

Conservatoire national des arts et métiers

Laboratoire de génie des procédés pour l'énergie, l'environnement et la santé (EA21)

Case 333 292 rue saint Martin 75141 Paris cedex 03 France

Phone : +33 1 40 27 24 42, Fax : +33 1 42 71 93 29

E-mail : georges.descombes@cnam.fr

\*Corresponding author

### Abstract

The current environmental context dictates to reduce the pollutant emissions by improving thermal efficiency of the energy production units. The authors present some studies of cogeneration applications using gas turbines and thermal engines. The on-going research concerns a detailed study of thermodynamic modelling cycles with energy recovery. These combined cycles with gas turbine and ICE can generate a potential increase of about 10% of the energy efficiency. They will generate a technological complexity and the over-charge must be estimated. At last, the authors insist on the necessary synergy between gas turbines and thermal engines.

**Keywords:** gas turbine, internal combustion engine, combined cycles, combined heat and power plants, cogeneration, efficiency.

### Nomenclature

T [K]	Temperature
S [J.kg <sup>-1</sup> .K <sup>-1</sup> ]	Entropy
q [J.kg <sup>-1</sup> ]	Heat
Ex [J.kg <sup>-1</sup> ]	Exergy
An [J.kg <sup>-1</sup> ]	Anergy
En [J.kg <sup>-1</sup> ]	Chemical energy
Ec	Cogeneration efficiency
$\eta$	Efficiency
k	Coefficient
$\dot{m}$ [kg/s]	Mass flow rate
P [Pa]	Pressure
U [J/kg]	Internal energy
H [J/kg]	Enthalpy
H [W/m <sup>2</sup> .K]	Heat exchange coefficient
V [m/s]	Velocity
Vol [m <sup>3</sup> /kg]	Specific volume
Nu	Nusselt number
Pr	Prandtl number
Re	Reynolds number
$\varphi$ [W/m <sup>2</sup> ]	Heat flux density
$\varepsilon$	Surface emissivity

### Subscripts

c	Carnot
ex	Exergy
i	Internal
k	Indice
m	Mechanical
th	Thermal
c	Cogénération
0	Upstream
$\infty$	Infinite
w	Wall

### 1. Introduction

The expression of the efficiency  $\eta$  of a thermal engine arises from the combination of both laws of thermodynamics (relation 1) where  $\bar{T}$  and  $\bar{T}_0$  are the average exchange temperatures between the active fluid and the sources [1, 2]. The

amount of heat generated by the combustion reaction is  $q$ ,  $\Delta_i S_k$  are the entropy production generated by the irreversibilities of the energy transformation on each engine subassembly  $k$ . The thermal efficiency can then be written by reference to Carnot, following relation (2), as the product of the Carnot efficiency  $\eta_c$  and of the exergetic efficiency  $\eta_{ex}$  which depends on the level of losses given by the term of entropy production  $\Delta_i S$ .

$$\eta = \left[ 1 - \frac{\bar{T}_0}{\bar{T}} \right] \cdot \left[ 1 - \frac{\bar{T}_0 \sum_k \Delta_i S_k}{q \left[ 1 - \frac{\bar{T}_0}{\bar{T}} \right]} \right] \quad (1)$$

$$\eta = \eta_c \cdot \eta_{ex} \quad (2)$$

The chemical energy  $E_n$  is split up into two contributions described by relations 3 to 5. The exergy  $Ex$  (4) of the heat flux  $q$  at the temperature  $\bar{T}$  corresponds to the mechanical energy produced on the engine crankshaft. The anergy  $An$  (5) represents the thermal energy which is lost due to the intrinsic term  $q \frac{\bar{T}_0}{\bar{T}}$  on one hand and by the major entropy production  $\Delta_i S$  due to the irreversibilities on the other hand [3, 4].

$$E_n = Ex + An \quad (3)$$

$$Ex = q \left[ 1 - \frac{\bar{T}_0}{\bar{T}} \right] - \bar{T}_0 \Delta_i S \quad (4)$$

$$An = \sum_k q_k \frac{\bar{T}_0}{\bar{T}} + \bar{T}_0 \sum_k \Delta_i S_k \quad (5)$$

The global energy balance (3) shows that a fraction of these anergy  $A_n$  can be used partially for energy recovery applications. The energy balance applied in open system on a steady state operating condition (relation 6) shows that if the fraction  $E_x$  of the chemical energy  $E_n$  of the fuel is transformed into mechanical work, the anergy  $A_n$  rejected as heat to the outside remains preponderant,  $U$  being the internal energy,  $V$  the velocity of fluid particle,  $P$  its pressure and  $Vol$  its volume.

$$\Delta E_n = \left[ Ex + An \right]_{1 \rightarrow 2}^2 = U_2 + P_2 Vol_2 + \frac{V_2^2}{2} - U_1 - P_1 Vol_1 - \frac{V_1^2}{2} \quad (6)$$

Relations (7) and (8) describe the entropy evolution balance in steady state operation of the engine where  $dA_n$  represents the energy which is not transformed into work,  $TdS$  the entropy variation at the temperature level  $T$  which results from the convective contribution  $d_e S$  of the heat and mass transfer to the outside and of the internal entropy production  $d_i S$ . In this relation (8),  $\dot{q}_k$  is the thermal power exchanged at the local entropic temperature  $\bar{T}_k$  by each of the engine subassembly  $k$  with the outside,  $\dot{m}$  the gas mixture mass flow rate,  $\dot{s}_i$  the source term of internal entropy defined as a flux, the indices 1 and 2 identifying the energetic states of the matter transfer at the inlet and at the outlet of the thermal engine.

$$TdS = dAn \quad (7)$$

$$0 = \sum_k \left[ \frac{\dot{q}_k}{\bar{T}_k} \right] + S_1 \dot{m}_1 - S_2 \dot{m}_2 + \sum_k \Delta \dot{S}_{i_k} \quad (8)$$

The associated modeling of the heat exchanges by convection and radiation with the outside is most often based on correlations established in steady state (relation 9). Many authors assume that the energy radiated to the walls of the engine during combustion represents only a small fraction of the order of 4 to 20 % of the total energy released during the cycle [5]. The convective flux density to the walls is restricted, with this simplification that remains to be proved, to the formulation (10) in which  $\phi$  is the flux density,  $h_i$  the internal heat transfer coefficient,  $T_g$  and  $T_w$  the respective gas and wall temperatures. The heat transfer coefficient  $h_i$  is evaluated from correlation (11) between the non dimensional numbers Nusselt  $N_u$ , Prandtl  $P_r$  and Reynolds  $R_e$  in which the velocity is taken as the mean piston speed. In this

simplified modeling, which supposes a steady-flow forced-convection heat-transfer approach, the Prandtl number varies little and is about 0.7 for gases.

$$\frac{dq}{dt} = \frac{d}{dt} \left[ h + \frac{V^2}{2} \right] = \sum_A \dot{h}_g [T_w - T_\infty] dA + \sum_A \varepsilon \sigma [T_w^4 - T_\infty^4] dA \quad (9)$$

$$\dot{\varphi} = h [T_g - T_w] \quad (10)$$

$$Nu = k P_r^p R_e^q \quad (11)$$

The application of the above mentioned balances (1) to (11) in full load operation for a Diesel engine (Fig. 1) shows that a noticeable part of the thermal energy provided by the combustion reaction is rejected to the cylinder outside as energy not transformed into work (Fig. 2). An exergetic analysis is then necessary to calculate the efficiency of the devices aiming at recovering at least a portion of this thermal energy at the exhaust of the engine and in its cooling system [3, 4, 6, 7].

## 2. Energy recovery

### 2.1. Concept of thermal insulation

The engine cylinder head and cylinders can operate correctly only if they are cooled by water circulation. This cooling is considered as an unavoidable drawback, harmful to the engine efficiency. A currently widespread but however wrong idea is that the heat transferred to the cylinder walls can be transformed into work. A premature analysis can lead to wrong conclusions, by stating that one can reduce the energy  $An$  transferred to the engine cooling circuit to increase the mechanical exergy production  $Ex$ , keeping the same internal energy variation  $\Delta U$  (relation 8). This led to some attempts of thermal insulation developed in the sole objective of improvement of engine thermal efficiency. The reduction of this heat transfer at the water cooling jackets mostly led to deceiving results. Results were on the contrary encouraging when the objective was to increase the thermal energy level recoverable at the engine exhaust [6, 8, 9] (Fig. 3).

As a matter of fact, the experiments show that a reduction of the energy  $An$  transferred to the cooling circuit of the engine whose general shape of the thermodynamic cycle most often leads to an increase of the internal energy of the gases rejected in the exhaust. The production of mechanical exergy  $Ex$  is maintained at best, but it is also often degraded [10, 11]. Moreover, Diesel [12] has considered a combined isothermal and adiabatic compression cycle in his initial report, before recommending his famous constant pressure cycle.

The analysis of the energy balance of a thermal engine shows more than of the chemical energy is lost depending upon the application. A usual case of energy recovery concerns the simultaneous production of electrical energy and thermal energy [13, 14]. That is the case of the cogeneration applications such as the production of steam and hot water on one hand and trigeneration with additional cold energy production on the other hand.

The experience shows that the comparative efficiency of energy recovery applications between gas turbines and thermal engines is a function of output of the machines [15, 16]. In a first approach, the thermal efficiency of a Diesel engine is better than the efficiency of a single gas turbine in the range of the low output power, particularly at partial loads. This trend inverses for a range of output power, which is higher than some MW and more.

### 2.2. Gas turbine

Figure 4 shows the diagram of a usual scheme applied to a cogenerated gas turbine used in a power plant unit [16]. In this example, the electrical power is equal to 1000 kW and the thermal losses are mostly concentrated in the exhaust gas. The mass flow rate of the exhaust gas is 5.45 kg/s and the thermal recovery power is equal to 2175 kW when the exhaust gas are water-cooled from 500°C to 150°C. The mass flow rate of the hot water is equal to 95000 kg/h and the saturated steam production at 0,4 MPa is about 33000 kg/h. The overall efficiency of the power plant unit can reach 80%.

### 2.3. Diesel engine

Figure 5 shows the diagram case of an industrial turbocharged Diesel engine with energy recovery on water and oil cooling, exhaust and supercharging circuits. This thermal unit produces electrical energy and hot water to an urban city [13, 17]. The thermal efficiency of the engines is equal to 45%. The engine with 18 cylinders operates on heavy-duty fuel with a viscosity equal to 180 centistokes at 50°C and a sulphur content less than 1.5%. The electrical power is equal to 38.5MW. The cogeneration process allows to obtain a simultaneous thermal power equal to 30MW of hot pressurized water at 120°C and 1MW of water at low temperature at 70°C. The overall efficiency of this power plant unit is around 80% and the annual fuel saving compared with a non-cogeneration application is about 10 000 tonnes equivalent petroleum.

#### 2.4. Waste energy compared

We have seen that the major source of heat losses within a gas turbine is concentrated on the exhaust gas unlike an ICE, which imposes a more complicated technology to recover waste energy. Then, the levels of the temperature and the exhaust mass flow rate of the gas turbine can be adapted on the same machine as a function of user's needs with a simple branch circuit on the heat exchangers [18, 19]. The cogeneration efficiency  $E_c$  (relation 12) which is the ratio between recovery thermal energy  $E_{th}$  and mechanical work  $E_m$ , is higher in a gas turbine than thermal engines. This cogeneration efficiency, which can be evolved from 2 to 6, is distinctly higher than the cogeneration efficiency of an ICE which is about 0.5 to 2, but to the detriment for the gas turbine for its higher fuel consumption [18, 19].

$$E_c = \frac{E_{th}}{E_m} \quad (12)$$

### 3. Combined cycles with gas turbine

It is possible to model a series of cogenerated cycles having real industrial application possibilities [18, 19] and all the results of modelling program which are presented use systematically the thermodynamic balances (1) to (11). The first simulation (Fig. 6) concerns the evolutive range of waste heat recovery as a function of the ratio of the thermal energy recovered on the exhaust gas which is taken on the turbine circuit. The entropic diagram illustrates the case without derivation and with derivation toward the inlet of the combustion chamber (Fig. 7).

The performance of the machine can evolve as a function of the mass flow, which is by-passed in the exchanger (Fig. 8). The outlet temperature is a function of the level of the by-passed exhaust gas at the exchanger. The outlet temperature reaches a maximum value of 900K when non derivation is realised.

It is a linear decreasing function of the by pass ratio and the thermal energy is also maximum when there is no derivation. The calculation results give a potential increase of the thermal efficiency about 20% from 0.4 to 0.482. The ratio of the recovery thermal energy and mechanical work increases to 40% when the levels of gas temperature evolve from 500 to 900K.

### 4. Combined cycles with I.C.E.

#### 4.1. Depressurised cycle

Fig. 9 illustrates the schematic diagram applied to an ICE and Fig. 10 shows the thermodynamic depressurised cycle which is proposed in this application.

The calculation is done for an exhaust temperature of 1200K before variable geometry turbine. The pressure at the exit of the turbine is equal to 0.069 MPa and the temperature is 980K. Additional mechanical energy production realised on the rotor of the turbomachinery increases progressively from 2% to 8% of the energy generated on the crankshaft as a function of the load. In last, thermal energy recovery is realized in order to feed an exterior circuit.

The depressurised cycle is realised without preliminary compression [18, 19] and the heat is supplied at constant pressure  $P_0$ . The under expansion is realised until a level inferior to the ambient pressure (point D). An amount of thermal energy can be extracted from (D) to (E) for a cogeneration application at constant pressure. A cooling or non cooling compression can be operated until atmospheric pressure  $P_0$  (point F).

For a maximum temperature of the cycle that is fixed by the technology of the material, the level of pressure at the end of expansion is of course low compared to a classical cycle with exchanger. The density of the flow is also low and imposes the usage of a larger geometry of turbine and compressor to transfer the mass flow rate. We note that this increasing of the dimension of the machine is an advantage to decrease the losses within the blades and therefore the rotating speed is reduced by a factor of 3.

#### 4.2. Over expansion cycle

Over expansion cycle [18, 19] is illustrated at first on a combined and power scheme (Fig. 11). The thermodynamic cycle is presented in Fig. 12. This cycle consists of a preliminary compression (A-B) followed by a heat transfer at constant pressure (B-C). The expansion of the combustion gas is realised in three steps. Mechanical energy produced between (C-D) is used to compress the turbocharging air (A-B).

The work produced between (D-E) corresponds to the mechanical energy to be supplied to an exterior electrical circuit. The under expansion (E-F) correspond to the mechanical energy needed to operate the second compressor (G-H) that

will recompress the gas from the under expansion until ambient pressure  $P_0$ . The expanded gas at point F are cooled at constant pressure until G by means of an exchanger that extracts energy for cogeneration.

This cycle can improve the output power of the energy production unit as well as its efficiency by the choice of an optimum expansion ratio, which is a function of temperature levels and pressure ratio of the machine. Figure 13 illustrates the diagram of the combined cycle machine. Fig. 14 shows the thermodynamic over-expansion cycle. The modelling is led with an efficiency of the exchanger equal to 0.9 and the pressure losses progress from 2 to 7% in accordance with the studied application.

The level of temperature at the exhaust gas of the engine is fixed at 1000K and the cycle of the power unit is an over expansion cycle. The ratio of recovered thermal energy to work production is illustrated as a function of the temperature and the calculation shows that an additional recovery can be obtained. The optimal point is a function of the temperature level, pressure ratio and the amount of exchangers and the calculations show a potential thermal energy recovery from 10 % of the mechanical power.

## 5. Modelling results compared

The objective of depressurised and over-expansion cycles is to increase the turbocharging rate as well as the efficiencies. Table 1 illustrates the comparison between depressurised, over-expansion and simple exchanger cycles, taking into account frictional, mechanical and aerodynamic losses, variations in specific heat values ( $C_p$ ) and exact calculation of the Fuel / Air ratio (F/A). Optimum flow rate, efficiency, F/A ratio and rotational speed values are given for a power of 50 kW and a heat exchanger efficiency of 85%.

The technology of the exchanger cycle is the simplest, but with higher consumption and pollution rates and its angular rotational speed stays prohibitive for a power of 56 kW. The depressurised cycle can be suitable for a power range higher than 50 kW with a rotating speed reduced by a factor of 1,5-2 for the turbomachinery. The performances of the over expansion cycle are the best, but this expansion cycle is more suitable for a range of output power which is higher than 150 kW and more.

Cycle	Mass flow rate (g/s)	Efficiency	Fuel / Air ratio	Speed (rpm) rotor
Exchanger	229	0,409	0,0127	64000
Depressurised	194	0,414	0,0147	31000
Over expansion	193	0,431	0,0143	46000

**Table 1.** Compared performances of thermodynamic cycles

## 6. Conclusion

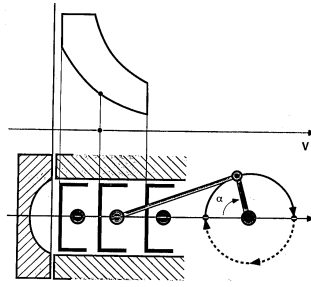
In this work, waste heat recovery aiming to increase the availability of the combined cycles and cogeneration has been studied. Non usual depressurised and over-expansion cycles have been studied and they can improve sensibly the efficiency of the power unit. Calculations show that thermal efficiency of the engine is increased by 4 to 5 points on its optimum working condition. These cycles can be used on a thermal engine with high supercharging at lean burn conditions, with cogeneration applications to produce cold energy and additional electrical energy.

The next step of this study will concern experimental work of the performances of a supercharging and combined unit. A variable geometry turbine dedicated to operate on an over expansion cycle will be realised. The authors intention has been also to suggest a real synergy between alternative engines and gas turbines in thermal and mechanical energy production domain. At last, Georges Descombes would like to honour the memory of Professor Serge Boudigues.

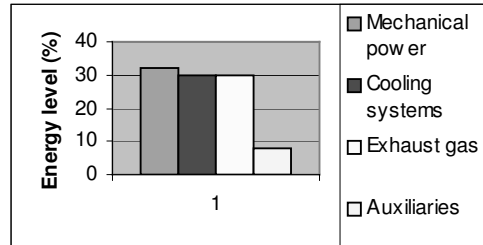
## REFERENCES

- [1] **Benelmir, R., Lallemand, A., Feidt, M., 2002**, Analyse exergetique, Techniques de l'ingénieur, BE 8 015, pp. 1-15.
- [2] **Lallemand, A., 2005**, Thermodynamique appliquée, bilans entropiques et exergetiques, Techniques de l'ingénieur, BE 8 008, pp. 1-18.
- [3] **Mc Govern, J.A., 1990**, Exergy analysis, a different perspective on energy, Part I, The concept of exergy, Journal of Power and Energy, Vol.204, ImechE, 1990.
- [4] **Mc Govern, J.A., 1990**, Exergy analysis, a different perspective on energy, Part II, Rational efficiency and some examples of exergy analysis, Journal of Power and Energy, Vol.204, ImechE, 1990.
- [5] **Trémoulière, G., Cambou, N., Vignon, J.M., 1987**, Etude de la modélisation des transferts thermiques dans la chambre de combustion d'un moteur Diesel, congrès international SIA, moteurs Diesel, pp.122-127, Ecole Centrale de Lyon, 13-14 mai 1987.
- [6] **Descombes, G., Maroteaux, F., Feidt, M., 2003**, Study of the interaction between energy and heat exchanges applied to IC engines, Applied Thermal Engineering, Vol. 23, issue 16, pp. 2061-2078, Nov. 2003.
- [7] **Volz, S., Lallemand, M., Saulnier, J.B., 2001**, Analyse de la conduction de la chaleur aux temps ultra-courts, Revue générale de thermique, Vol. 36, n°11, pp. 826, 835, dec 1997.
- [8] **Kawamura, H., Higashino, A., Sekiyama, S., 1996**, Combustion and combustion chamber for a low heat rejection engine, SAE Paper 960506, 1996.
- [9] **Rakopoulos, C.D., Andritsakis, E.C., Huontalas, D.T., 1995**, The influence of the exhaust system unsteady gas flow and insulation on the performance of a turbocharged Diesel engine, Heat Recovery Systems and CHP Journal, Vol. 15, N° 1, p.51-72, 1995.
- [10] **Peyrard, P., 1985**, Les moteurs Diesel adiabatiques, Mémoire d'ingénieur du Conservatoire National des Arts et Métiers, Paris, pp. 46-123, 1985.
- [11] **Giraud, O., 1984**, Contribution à l'étude de l'isolation thermique d'un moteur suralimenté à allumage par compression, Thèse de doctorat de l'Université P. et M. Curie, pp. 46-53, 14 décembre 1984.
- [12] **Diesel, R., 1900**, Le moteur thermique système Diesel, Congrès International de Mécanique Appliquée, exposition universelle, 19-25 juillet 1900, p. 487-508, Conservatoire National des Arts et Métiers, Paris 1900.
- [13] **Magnet, J.L., 1997**, International business conference on cogeneration, note SEMT PIELSTICK, RIO de JANEIRO, 1997.
- [14] **Haushalter, J., 1993**, La cogénération par moteurs alternatifs, Revue générale de thermique n° 383, novembre 1993.
- [15] **Sinatov, St., 1998**, Turbocharging helps to Diesel engine in cogeneration and combined cycles, International council on combustion engines, 22<sup>nd</sup> CIMAC, Copenhagen, 18-21 may 1998, Vol. 6, pp. 1607-1612, 1998.
- [16] **Grone, O. and Lausch, W., 1998**, Prime mover systems for Diesel power plants, International council on combustion engines, 22<sup>nd</sup> CIMAC, Copenhagen, 18-21 may 1998, Vol. 6, pp.1621-1634, 1998.
- [17] **Marque, M., 1990**, Production combinée de force, chaleur et froid, rapport de l'association technique de l'industrie du gaz en France, 1990.
- [18] **Boudigues, S., Descombes, G., Neveu, P., Prévond, L., 2001**, Contribution à l'optimisation des performances d'unités de production d'énergie cogénérées, 2<sup>th</sup> International Heat Powered Cycles Conference, Cooling, Heating and Power Generation systems, University of Nottingham & Conservatoire national des arts et métiers, Paris, September 2001.
- [19] **Boudigues, S., Descombes, G., Jullien, J. Neveu, P., 2002**, Production d'énergie par cogénération et optimisation du cycle thermodynamique, Entropie n° 241, pp. 60-64, 2002.
- [20] **Descombes, G., Pichouron, J.F., Maroteaux, F., Moreno, N., 2002**, Simulation of the performance of a variable geometry turbocharger for Diesel engine road propulsion, International journal of applied thermodynamics, Vol. 5, N° 3, pp. 139-149, ISSN 1301-9724, September 2002.
- [21] **Toussaint, M., Descombes, G., Pluviose, M., 1999**, Research into variable geometry turbochargers without wastegates, 3<sup>rd</sup> European conference on turbomachinery, fluid dynamics and thermodynamics, 2-5 march 1999, IMechE, London, pp. 883-891, ISSN 1356-1448, 1999.





**Fig. 1.** Thermodynamic cycle of a volumetric engine



**Fig. 2.** Energy balance of an automotive engine at full load

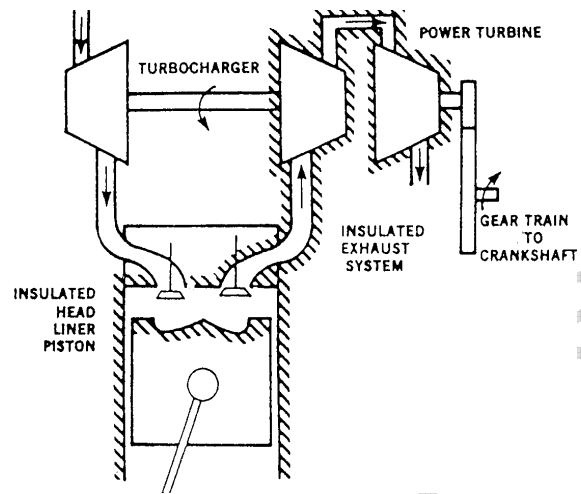
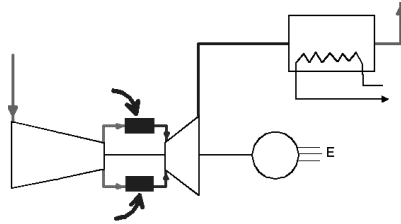


Fig. 3. Insulated thermal engine



**Fig. 4.** Waste heat recovery within a gas turbine

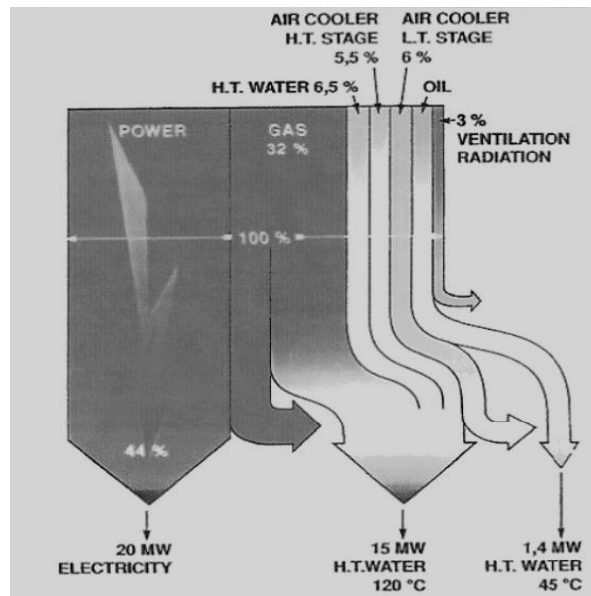
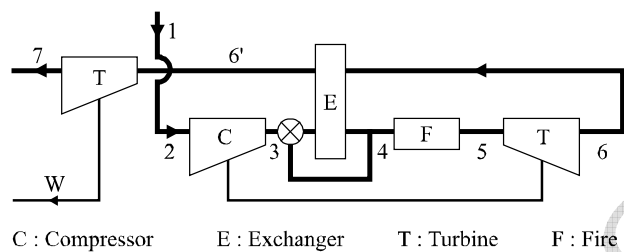
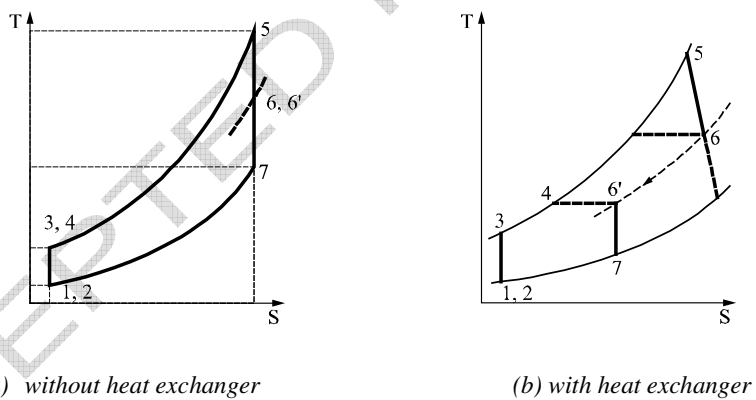


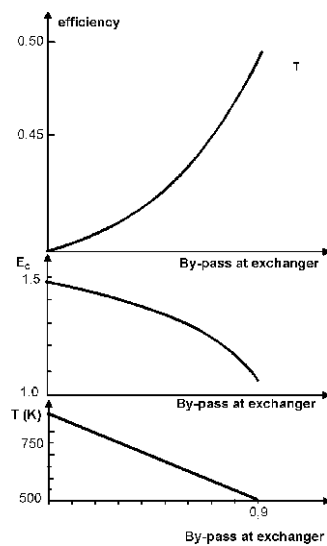
Fig. 5. Waste heat recovery within a thermal engine



**Fig. 6.** Waste heat energy recovered on the exhaust gas of a gas turbine



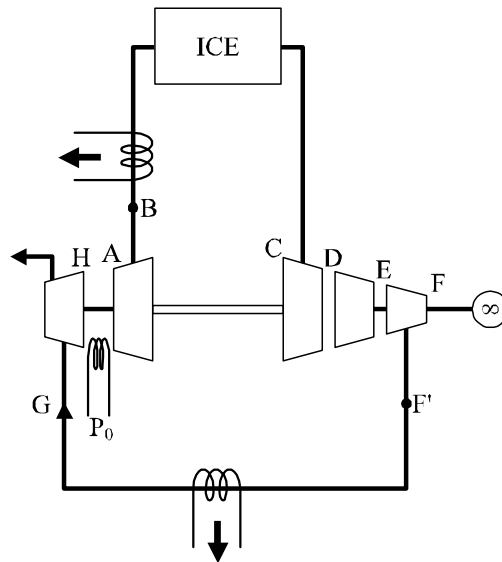
**Fig. 7.** Entropy diagram as a function of the ratio of the thermal energy recovered



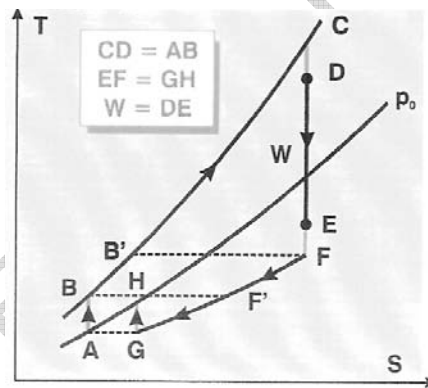
**Fig. 8.** Thermodynamic values as a function of the heat energy recovered on the exhaust gas



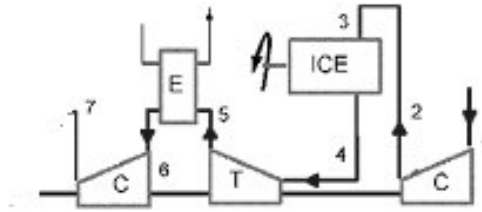




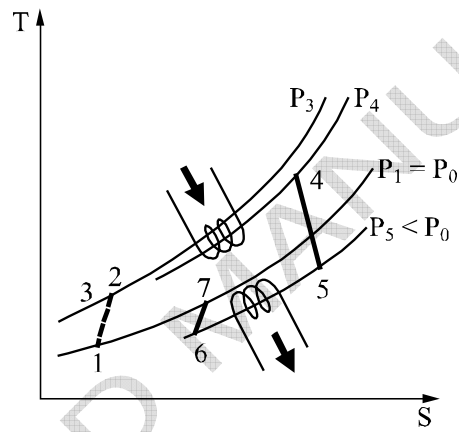
**Fig.11.** Over expansion scheme of a combined application



**Fig. 12.** Entropy diagram of the over-expansion cycle



**Fig. 13.** Over-expansion cycle applied to a combined application  
*C* Compressor  
*ICE* Internal combustion engine  
*T* Turbine  
*E* Exchanger



**Fig. 14.** Entropy diagram of an over-expansion cycle applied to a combined application