



HAL
open science

Geometric representations of the braid groups

Fabrice Castel

► **To cite this version:**

| Fabrice Castel. Geometric representations of the braid groups. 2010. hal-00586479

HAL Id: hal-00586479

<https://hal.science/hal-00586479>

Preprint submitted on 19 Apr 2011

HAL is a multi-disciplinary open access archive for the deposit and dissemination of scientific research documents, whether they are published or not. The documents may come from teaching and research institutions in France or abroad, or from public or private research centers.

L'archive ouverte pluridisciplinaire **HAL**, est destinée au dépôt et à la diffusion de documents scientifiques de niveau recherche, publiés ou non, émanant des établissements d'enseignement et de recherche français ou étrangers, des laboratoires publics ou privés.

Geometric representations of the braid groups

Fabrice Castel*

October 2010

Abstract: We call *geometric representation* any representation of a group in the mapping class group of a surface. Let $\Sigma_{g,b}$ be the orientable connected compact surface of genus g with b boundary components, and $\mathcal{PMod}(\Sigma_{g,b})$ the associated mapping class group preserving each boundary component. The main theorem of this paper concerns geometric representations of the braid group \mathcal{B}_n with $n \geq 6$ strands in $\mathcal{PMod}(\Sigma_{g,b})$ subject to the only condition that $g \leq n/2$. We prove that under this condition, such representations are either *cyclic*, that is, their images are cyclic groups, or are what we call *transvections of monodromy homomorphisms*, defined in the text.

This leads to different results. They will be proved in later papers, but we explain for each of them how they are deduced from our main theorem. These corollaries concern five families of groups: the braid groups \mathcal{B}_n for all $n \geq 6$, the Artin groups of type D_n for all $n \geq 6$, the Artin groups of type E_n for $n \in \{6, 7, 8\}$, the mapping class groups $\mathcal{PMod}(\Sigma_{g,b})$ (preserving each boundary component) and the mapping class groups $\mathcal{Mod}(\Sigma_{g,b}, \partial\Sigma_{g,b})$ (preserving the boundary pointwise), for all $g \geq 2$ and all $b \geq 0$. For each of these five families except the Artin groups of type E_n , we are able to describe precisely the (always remarkable) structure of the endomorphisms.

Keywords: surface, mapping class group, braid group, rigidity, geometric representation, Nielsen Thurston's classification, transvection, monodromy morphism.

AMS Subject Classification: Primary 20F38, 57M07. Secondary 57M99, 20F36, 20E36, 57M05.

*Research partially supported by National University of Singapore Research Grant R-146-000-137-112

Contents

1	Introduction	4
1.1	Presentation of the main objects	4
1.2	The main theorems: Theorems 1, 2 and 3	4
1.3	Summary of the Corollaries	6
1.4	Outline	7
2	Corollaries of Theorems 1, 2 and 3: Theorems 4 - 15	7
2.1	Homomorphisms between braid groups	7
2.2	Homomorphisms between mapping class groups	9
2.3	Endomorphisms and automorphisms of the mapping class group	14
2.4	Rigidity/triviality of the homomorphisms from $\text{Mod}(\Sigma_{g,0})$ to $\text{Mod}(\Sigma_{g',0})$	15
2.5	Geometric representations of the Artin groups of type D_n, E_6, E_7 and E_8	16
2.6	Endomorphisms and automorphisms of the Artin groups of type D_n	19
	Proof of Theorems 2 and 3	20
3	On monodromy homomorphisms	21
3.1	Cyclic homomorphisms, monodromy homomorphisms and transvections	21
3.2	Proof of Theorem 2	23
3.3	Centralizer of the monodromy homomorphisms	27
3.4	Proof of Theorem 3	30
	Proof of Theorem 1	34
	Summary of the upcoming notation	34
	Outline of the proof of Theorem 1	35
4	On geometric representations of \mathcal{B}_n in nonempty-boundary surfaces	36
4.1	Geometric representations of \mathcal{B}_n in genus-0 surfaces are cyclic	36
4.2	Peripheral curves	37
5	Irreducible geometric representations of \mathcal{B}_n	40
5.1	Cardinalities of some abelian subgroups of $\rho(\mathcal{B}_n)$	41
5.2	Periodic geometric representations of \mathcal{B}_n	45
5.3	Pseudo-Anosov geometric representations of \mathcal{B}_n	48
6	Adding an n^{th} generator to the standard presentation of \mathcal{B}_n	50
7	The special curves $\sigma_s(\mathcal{G}_0)$	51
7.1	Action of \mathcal{B}_n on the simplexes of curves	52
7.2	Curve simplexes which are orbits under \mathcal{J} in $\sigma(\mathcal{G}_0)$ have less than n curves	55
7.3	Partition of $\sigma(\mathcal{G}_0)$: $\sigma(\mathcal{G}_0) = \sigma_s(\mathcal{G}_0) \sqcup \sigma_n(\mathcal{G}_0)$	69
7.4	Stability and existence results	70
8	The special curves are not separating	74
8.1	The subgroup \mathcal{H} of \mathcal{B}_n and its action on the subset \mathcal{X} of \mathcal{G}_0	74
8.2	Proof of Proposition 8.1	75

9	Description of $\sigma(\mathcal{X})$ in Σ	81
9.1	Action of \mathcal{H} on \mathcal{X} and \mathcal{H} -colorations	82
9.2	Description of the embedding of $\sigma_s(\mathcal{X})$ in Σ	84
9.3	Description of $\sigma_n(\mathcal{G}_0)$ and of $\sigma(\mathcal{X})$ in Σ	91
10	Expression of the mapping classes of \mathcal{G}_0	94
10.1	The homomorphism $\widehat{\rho}$ induced by ρ on $\mathcal{M}od(\widehat{\Sigma})$	94
10.2	The homomorphism ρ is a transvection of monodromy homomorphism	104
10.3	Proof of Theorem 1 when n is even	106
10.4	Proof of Theorem 1 when n is odd	106
	Appendix	107
A	Miscellaneous on the mapping class group	107
A.1	Parabolic subgroups of the mapping class group	107
A.2	Interactions between Dehn twists and the braid group	107
A.3	Periodic Mapping classes	109
A.3.1	Kerckhoff's Theorem, Riemann-Hurwitz formula, and related results . . .	109
A.3.2	When periodic mapping classes preserve a boundary component	111
A.4	The theory of Pseudo-Anosov diffeomorphisms.	115
A.5	Reducible mapping classes, Thurston's theory and the canonical reduction system	119
	References	123

1 Introduction

Some theorems have been established concerning injective endomorphisms of the braid groups or the mapping class groups. For both families of groups, the outer automorphisms groups were first computed, in 1981 by Dyer and Grossman, [DyGr], for the braid groups, and in 1986 - 1988 by Ivanov, [Iv1], and McCarthy, [Mc1], for the mapping class groups. Later, again for both families of groups, the set of the injective endomorphisms was described, in 1999 by Ivanov and McCarthy, [IvMc], for the mapping class groups, and in 2000 by Bell and Margalit, [BeMa], for the braid groups. For both families of groups, the previous authors could say a little more on injective endomorphisms between two different braid groups or the mapping class groups of two distinct surfaces, with strong restrictions, though. Our main theorem concerns the homomorphisms from the braid group in the mapping class group, making the bridge between both families of groups. As corollaries, we are able to prove the previous theorems and even to strengthen them by getting rid of the injective hypothesis.

1.1 Presentation of the main objects

The surfaces in this paper will always be compact, orientable and oriented 2-manifold whose each connected component is of negative Euler characteristic. They may have nonempty boundary. Classically, we denote by $\partial\Sigma$ the topological boundary of a surface Σ and we denote by $\Sigma_{g,b}$ the connected surface of genus g with b boundary components. Implicitly, g and b will always satisfy $2 - 2g - b \leq -1$.

The mapping class groups $\mathcal{M}\text{od}(\Sigma)$ of a surface Σ is the group of isotopy classes of orientation-preserving diffeomorphisms of Σ . We denote by $\mathcal{P}\mathcal{M}\text{od}(\Sigma)$ the finite index subgroup of $\mathcal{M}\text{od}(\Sigma)$ consisting of elements of $\mathcal{M}\text{od}(\Sigma)$ that permute neither the connected components, nor the boundary components.

A geometric representation of a group G is a homomorphism from G in the mapping class group of some surface $\Sigma_{g,b}$. For instance, J. Birman, A. Lubotsky and J. McCarthy have shown in [BiLuMc] that the maximal rank of the abelian subgroups of the mapping class group $\mathcal{M}\text{od}(\Sigma_{g,b})$ is equal to $3g - 3 + b$. In other words, they have shown that the group \mathbb{Z}^n has faithful geometric representations in $\mathcal{M}\text{od}(\Sigma_{g,b})$ if and only if $n \leq 3g - 3 + b$ holds. In this paper, we will investigate geometric representations of the braid group.

The braid group \mathcal{B}_n on n strands is the group defined by the following presentation, which we will call the *classic presentation*:

$$\mathcal{B}_n = \langle \tau_1, \tau_2, \dots, \tau_{n-1} \mid \left\{ \begin{array}{l} \tau_i \tau_j = \tau_j \tau_i \text{ if } |i - j| \neq 1 \\ \tau_i \tau_j \tau_i = \tau_j \tau_i \tau_j \text{ if } |i - j| = 1 . \end{array} \right. \rangle$$

The generators of this presentation are called the *standard generators of \mathcal{B}_n* .

1.2 The main theorems: Theorems 1, 2 and 3

The aim of this paper is to describe all geometric representations of the braid group \mathcal{B}_n in the mapping class groups $\mathcal{P}\mathcal{M}\text{od}(\Sigma_{g,b})$ and $\mathcal{M}\text{od}(\Sigma_{g,b}, \partial\Sigma_{g,b})$. The only hypothesis is that the number n of strands of \mathcal{B}_n and the genus g of the surface $\Sigma_{g,b}$ must satisfy:

$$g \leq \frac{n}{2},$$

whereas b is any nonnegative integer, as long as the surface $\Sigma_{g,b}$ is of negative Euler characteristic. Notice that the elements of $\mathcal{P}\text{Mod}(\Sigma_{g,b})$ and $\text{Mod}(\Sigma, \partial\Sigma_{g,b})$ do not permute the boundary components of the surface. Under these assumptions, we will show that all *non-cyclic* representations (that is, whose images are not cyclic groups) of the braid group are “variations” of the classical monodromy representations defined below. As an illustration of this fact, when n is odd, all non-cyclic representations of \mathcal{B}_n are *not far from* being conjugate from each other.

A monodromy representation of \mathcal{B}_n will be a geometric representation of \mathcal{B}_n which sends the different standard generators of \mathcal{B}_n on distinct Dehn twists (or their inverses). We recall that the Dehn twist T_c along a simple closed curve c in a surface Σ is the mapping class of $\text{Mod}(\Sigma)$ defined as follows. Let A denote an annular neighbourhood of c . Then T_c is the isotopy class of the homeomorphism which is the identity on $\Sigma \setminus \text{int}(A)$ and transforms the interior of A as shown in Figure 1. Remember that two Dehn twists T_a and T_b along two distinct curves a and b verify

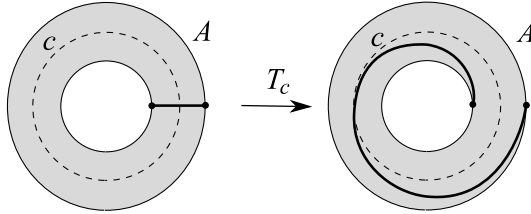

Figure 1: a Dehn twist along a curve c .

$T_a T_b T_a = T_b T_a T_b$ if and only if the curves a and b meet in one point, whereas they commute if and only if the curves a and b are disjoint. Consequently, a monodromy representation of \mathcal{B}_n can be characterized by the data of an integer $\varepsilon \in \{\pm 1\}$ and a n -chain of curves, that is to say an ordered $(n-1)$ -tuple of curves $(a_1, a_2, \dots, a_{n-1})$ such that for all $i, j \in \{1, \dots, n-1\}$, the curves a_i and a_j are disjoint when $|i-j| \neq 1$, and intersect in exactly one point when $|i-j| = 1$. So the monodromy representation ρ associated to the couple $((a_1, a_2, \dots, a_{n-1}), \varepsilon)$ is defined by setting for all $i \leq n-1$:

$$\rho(\tau_i) = T_{a_i}^\varepsilon.$$

Let n be an integer greater than or equal to 3. Let G be any group, ρ a homomorphism from \mathcal{B}_n to G and w an element lying in the centralizer of $\rho(\mathcal{B}_n)$ in G . The *transvection* ρ_1 of ρ with *direction* w is the homomorphism defined by setting for all $i \leq n-1$:

$$\rho_1(\tau_i) = \rho(\tau_i) w.$$

A transvection of a monodromy representation ρ of \mathcal{B}_n is thus characterized by a (unique, as will be shown later) triple $((a_1, a_2, \dots, a_{n-1}), \varepsilon, W)$ where W is a mapping class which preserves each curve a_i , $i \leq n-1$, and is defined by setting for all $i \leq n-1$:

$$\rho(\tau_i) = T_{a_i}^\varepsilon W.$$

We denote by $\Sigma(\rho)$ the tubular neighbourhood of the union of the curves a_i where i ranges from 1 to $n-1$. As will be shown in Proposition 3.9, W must preserve $\Sigma(\rho)$ and induces in $\text{Mod}(\Sigma(\rho))$ either the identity or the *hyper-elliptic element* related to the curves $(a_1, a_2, \dots, a_{n-1})$, that is, the only involution of $\Sigma(\rho)$ that preserves a_i and that swaps both sides of its tubular neighbourhood, for all $i \in \{1, \dots, n-1\}$.

A cyclic representation of \mathcal{B}_n is a representation whose image is cyclic. Equivalently, all the standard generators of \mathcal{B}_n have the same image.

Here is the main theorems of this paper.

Theorem 1 (Representations of \mathcal{B}_n in $\mathcal{PMod}(\Sigma)$ with $n \geq 6$).

Let n be an integer greater than or equal to 6 and Σ a surface $\Sigma_{g,b}$ with $g \leq \frac{n}{2}$ and $b \geq 0$. Then any representation ρ of \mathcal{B}_n in $\mathcal{PMod}(\Sigma)$ is either cyclic, or is a transvection of monodromy representation. Moreover, such transvections of monodromy representations exist if and only if $g \geq \frac{n}{2} - 1$.

Let $\text{Mod}(\Sigma, \partial\Sigma)$ be the group of isotopy classes of all orientation-preserving diffeomorphisms that coincide with the identity on $\partial\Sigma$. Then:

Theorem 2 (Representations of \mathcal{B}_n in $\text{Mod}(\Sigma, \partial\Sigma)$ with $n \geq 6$).

Theorem 1 still holds when $\mathcal{PMod}(\Sigma)$ is replaced by $\text{Mod}(\Sigma, \partial\Sigma)$.

In addition, we have an easy characterization of the faithfulness of the geometric representations of \mathcal{B}_n when the genus verifies $g \leq \frac{n}{2}$.

Theorem 3 (Faithful geometric representation of the braid groups).

Let n be an integer greater than or equal to 6 and Σ a surface $\Sigma_{g,b}$ with $g \leq \frac{n}{2}$.

Let ρ be a homomorphism from \mathcal{B}_n to $\text{Mod}(\Sigma, \partial\Sigma)$ or to $\mathcal{PMod}(\Sigma)$.

(i) Case of $\text{Mod}(\Sigma, \partial\Sigma)$. The homomorphism ρ is injective if and only if it is a transvection of monodromy homomorphism such that the boundary components of $\Sigma(\rho)$ do not bound any disk in Σ .

(ii) Case of $\mathcal{PMod}(\Sigma)$. The homomorphism ρ is injective if and only if it is a transvection of monodromy homomorphism such that boundary components of $\Sigma(\rho)$ do not bound any disk in Σ and at least one boundary component of $\Sigma(\rho)$ is not isotopic to any boundary component of Σ .

Theorems 1, 2 and 3 answer the natural question: “What are the (injective and not injective) homomorphisms between two classical groups?”. A similar work has been undertaken by E. Artin (cf. [At3]) and V. Lin (cf. [Ln2]) concerning the homomorphisms from \mathcal{B}_n to the symmetric group \mathfrak{S}_m with $m \leq n$ (Artin, 1947) and then with $m \leq 2n$ (Lin, 1970 - 2004). However, the importance of Theorems 1, 2 and 3 comes above all from their corollaries (see a quick description below, and a detailed description in Section 2).

1.3 Summary of the Corollaries

We will deduce the following from Theorems 1, 2 and 3:

- (i) description of the homomorphisms from \mathcal{B}_n to \mathcal{B}_m with $m \leq n + 1$. This generalizes a theorem of Bell and Margalit (see [BeMa]) to the non-injective case;
- (ii) triviality of $\text{Mod}(\Sigma_{g,b}) \rightarrow \text{Mod}(\Sigma_{g',b'})$ as soon as $g' < g$, which generalizes a theorem of W. Harvey and M. Korkmaz (see [HvKo]) to the nonempty boundary case;

- (iii) triviality of $\mathcal{M}\text{od}(\Sigma_{g,0}) \rightarrow \mathcal{M}\text{od}(\Sigma_{g+1,0})$, which is a partial answer to a conjecture of J. Berrick and M. Matthey (see [BkMt]) – this case can also be derived from the number theoretic conditions of [BkMt];
- (iv) description of homomorphisms $\mathcal{M}\text{od}(\Sigma_{g,b}) \rightarrow \mathcal{M}\text{od}(\Sigma_{g+1,b})$; which is a generalization in several ways of a theorem of N. Ivanov and J. McCarthy (see [IvMc]);
- (v) non-injectivity of all geometric representations of $A(E_n)$ ($n \in \{6, 7, 8\}$) in the expected mapping class groups. This completes a Theorem of B. Wajnryb (see [W]);
- (vi) description of the endomorphisms (and automorphisms) of $A(D_n)$ which is a generalization in several ways of a theorem of J. Crisp and L. Paris (see [CrPa], Theorem 4.9).

The major improvement of these theorems in comparison with older similar ones comes from the fact that we deal with homomorphisms instead of injective homomorphisms. In addition, we gather these various theorems as consequences of one single main result (essentially Theorem 2). In Section 2, we state precisely these corollaries and we explain how to prove them from Theorem 2. We postpone detailed proofs to further publications. However, the interested reader is referred to the author's Ph.D thesis for what concerns items (i) - (iv), cf. [Ca].

1.4 Outline

The organization of this paper is as follows. We present in Section 2 the corollaries of Theorems 1, 2 and 3 and explain briefly how the former can be deduced from the latter. In Section ??, we introduce the main definitions and fix the notations concerning surfaces and their mapping class groups. We also give some general results on mapping class groups that we shall use later on. Most of them are well-known. Those ones that are not are proved in the appendix section. In Section 3, we show an important result about lifting braid group geometric representations from $\mathcal{P}\mathcal{M}\text{od}(\Sigma)$ to $\mathcal{M}\text{od}(\Sigma, \partial\Sigma)$. We then deduce Theorems 2 and 3 from this result and Theorem 1. Sections 4 to 10 are devoted to the proof of Theorem 1. The major tool will be Nielsen - Thurston's theory and the canonical reduction system, denoted by $\sigma(F)$ for a mapping class F , which were introduced by Birman, Lubotzky, McCarthy and Ivanov in [BiLuMc] and [Iv2]. The key point of our proof will consist in finding a nice partition of $\sigma(A_i)$ where the A_i are the images of the standard generators of the braid group for a given geometric representation. This is done in Section 7.

2 Corollaries of Theorems 1, 2 and 3: Theorems 4 - 15

2.1 Homomorphisms between braid groups

The description of the homomorphisms between braid groups involves the Garside element Δ_n of the braid group \mathcal{B}_n , defined by $\Delta_n = \tau_1(\tau_2\tau_1) \dots (\tau_{n-1}\tau_{n-2} \dots \tau_1)$, and the unique involution Inv of the braid group that sends each standard generator on its inverse.

Theorems 2 and 3 allow us to show the following.

Theorem 4 (Homomorphisms between braid groups).

Let n and m be two integers such that $n \geq 6$ and $3 \leq m \leq n + 1$.

- (i) Case where $m < n$: ([Ln1], 1982) any homomorphism φ from \mathcal{B}_n to \mathcal{B}_m is cyclic.
- (ii) Case where $m = n$: any noncyclic endomorphism φ of \mathcal{B}_n is a transvection of inner automorphism possibly precomposed by the involution Inv : there exist $\gamma \in \mathcal{B}_n$, $\varepsilon = \pm 1$ and $k \in \mathbb{Z}$ such that for all $i \leq n - 1$, we have:

$$\varphi(\tau_i) = \gamma \tau_i^\varepsilon \gamma^{-1} \Delta_n^{2k}.$$

Such a homomorphism φ is always injective and is an automorphism if and only if $k = 0$.

- (iii) Case where $m = n + 1$: let us consider the group \mathcal{B}_n as the subgroup of \mathcal{B}_{n+1} spanned by the $n - 1$ first standard generators of \mathcal{B}_{n+1} . Then, any homomorphism φ from \mathcal{B}_n to \mathcal{B}_{n+1} is the restriction to \mathcal{B}_n of a homomorphism from \mathcal{B}_{n+1} in itself, up to transvection. According to item (ii), if φ is not cyclic, then there exist $\gamma \in \mathcal{B}_{n+1}$, $\varepsilon = \pm 1$ and $k, \ell \in \mathbb{Z}$ such that for all $i \leq n - 1$, we have:

$$\varphi(\tau_i) = \gamma \tau_i^\varepsilon \Delta_n^{2k} \gamma^{-1} \Delta_{n+1}^{2\ell}.$$

Such a homomorphism φ is always injective (but never surjective).

Historically, the first result in this direction was found in 1981: Dyer and Grossman computed algebraically the outer automorphisms group of \mathcal{B}_n and shew that $\text{Out}(\mathcal{B}_n) = \mathbb{Z}/2\mathbb{Z}$ for any $n \geq 2$. As we easily can show that nontrivial transvections of automorphisms of the braid groups are never onto, Theorem 4 provides a new proof of their theorem. In 1982, Lin shew that all homomorphisms from \mathcal{B}_n to \mathcal{B}_m with $m < n$ are trivial (see [Ln1]). Then, in 2000, R. Bell and D. Margalit described all the injective homomorphisms from \mathcal{B}_n to \mathcal{B}_n and \mathcal{B}_{n+1} (see [BeMa]). Their proof used an algebraic characterization of the braid twists in which the maximal rank of the abelian subgroups of \mathcal{B}_n played a central role (that is why they needed the homomorphisms to be injective). Keeping in mind these results, the new part of Theorem 4 is the following:

The only non-injective homomorphisms from \mathcal{B}_n to \mathcal{B}_n or \mathcal{B}_{n+1} are cyclic.

In addition Theorem 4 provides a unified proof for all these results.

Steps of the proof of Theorem 4.

Step 1. Let $m \leq n + 1$ and let φ be a non-cyclic homomorphism from \mathcal{B}_n to \mathcal{B}_m . Let Σ be the connected surface of genus $\lfloor \frac{m-1}{2} \rfloor$ with one or two boundary components depending on m . Let us denote by ρ a faithful representation of \mathcal{B}_m in $\text{Mod}(\Sigma, \partial\Sigma)$. Thus we have an $(m - 1)$ -chain of curves $(c_i)_{i \leq m-1}$ such that for all $i \leq m - 1$, we have:

$$\rho(\tau_i) = T_{c_i}. \tag{1}$$

Let us consider the following commutative diagram.

$$\begin{array}{ccc} \mathcal{B}_n & \xrightarrow{\rho \circ \varphi} & \text{Mod}(\Sigma, \partial\Sigma) \\ & \searrow \varphi & \nearrow \rho \\ & & \mathcal{B}_m \end{array}$$

According to Theorem 2, $\rho \circ \varphi$ is a transvection of monodromy homomorphism, so there exists a triple $((a_i)_{i \leq n-1}, \varepsilon, V)$ such that for all $i \in \{1, 2, \dots, n - 1\}$, we have:

$$\rho \circ \varphi(\tau_i) = T_{a_i}^\varepsilon V. \quad (2)$$

Step 2. The existence of the $(n - 1)$ -chain of curves $(a_i)_{i \leq n-1}$ implies that $n \leq m$, whence Theorem 4.(i).

Step 3. We deduce from (1) and (2) that there exists a mapping class F lying in the normalizer of $\rho(\mathcal{B}_n)$ in $\mathcal{M}od(\Sigma, \partial\Sigma)$ such that $F(c_i) = a_i$.

Step 4. This is the hard part: we have to compute the normalizer of $\rho(\mathcal{B}_n)$ in $\mathcal{M}od(\Sigma, \partial\Sigma)$ and show that F can be chosen in $\rho(\mathcal{B}_n)$. Then for all $i \leq n - 1$, we have:

$$T_{a_i} = \rho(\gamma\tau_i\gamma^{-1}). \quad (3)$$

Step 5. It remains to see that V lies in $\rho(\mathcal{B}_n)$. Let $v \in \mathcal{B}_n$ such that $V = \rho(v)$. We then have:

$$\rho \circ \varphi(\tau_i) = \rho(\gamma\tau_i^\varepsilon\gamma^{-1}v). \quad (4)$$

But ρ is injective, so (4) implies:

$$\varphi(\tau_i) = \gamma\tau_i^\varepsilon\gamma^{-1}v. \quad (5)$$

Since V lies in the centralizer of $\text{Im}(\rho \circ \varphi)$ and since ρ is injective, v must belong to the centralizer of $\langle \gamma\tau_i\gamma^{-1}, i \leq n - 1 \rangle$, so $\gamma^{-1}v\gamma$ belongs to the centralizer of \mathcal{B}_n in \mathcal{B}_m , whence the expression of v .

2.2 Homomorphisms between mapping class groups

We introduce $\mathcal{M}od^\pm(\Sigma)$: the group of isotopy classes of *all* diffeomorphisms of Σ (they may inverse Σ 's orientation).

Preliminaries.

- Homomorphisms from $\mathcal{M}od(\Sigma, \partial\Sigma)$ to $\mathcal{M}od(\Sigma', \partial\Sigma')$ induced by an embedding.** Let Σ and Σ' be two connected oriented surfaces. Let F be the isotopy class of a possibly non-orientation-preserving embedding from Σ in Σ' . Then F induces a homomorphism Ad_F from $\mathcal{M}od(\Sigma, \partial\Sigma)$ to $\mathcal{M}od(\Sigma', \partial\Sigma')$ as follows. Let $A \in \mathcal{M}od(\Sigma, \partial\Sigma)$ and let \bar{A} be a diffeomorphism of Σ that represents A . Let $\Sigma'' = F(\Sigma)$ and let \bar{F} be a diffeomorphism from Σ into Σ'' that represents F . Then the isotopy class of $\bar{F}\bar{A}\bar{F}^{-1}$ belongs to $\mathcal{M}od(\Sigma'', \partial\Sigma'')$ and induces canonically a mapping class in $\mathcal{M}od(\Sigma', \partial\Sigma')$ which we denote by $\widetilde{\text{Ad}}_F(A)$. Such a homomorphism $\widetilde{\text{Ad}}_F$ will be called *the homomorphism from $\mathcal{M}od(\Sigma, \partial\Sigma)$ to $\mathcal{M}od(\Sigma', \partial\Sigma')$ induced by the embedding F* .
- Outer conjugations.** In the above description, when $\Sigma'' = \Sigma'$, we can identify Σ' and Σ so that the embedding F becomes an element of $\mathcal{M}od^\pm(\Sigma)$. The homomorphism $\widetilde{\text{Ad}}_F$ that we get is then an automorphism of $\mathcal{M}od(\Sigma, \partial\Sigma)$. In this case, $\widetilde{\text{Ad}}_F$ will be called an *outer conjugation by F* .
- Hyper-elliptic Involution.** Given a surface $\Sigma = \Sigma_{g,b}$ with $b \in \{0, 1, 2\}$ and a m -chain of curves $(a_i)_{i \leq m}$ in Σ where $m = 2g + 1$ if $b = 1$ and $m = 2g + 2$ if $b \in \{0, 2\}$. The *hyper-elliptic involution of Σ relative to $(a_i)_{i \leq m}$* is the unique involution of $\mathcal{M}od(\Sigma)$ which preserves each curve $a_i, i \leq m$. It can be represented by an angle π rotation over an axis δ cutting the surface in $m + 1$ points. If $\Sigma = \Sigma_{2,0}$, all the hyper-elliptic involutions coincide and will be denoted by H ; in this case, H spans the center of $\mathcal{M}od(\Sigma_{2,0})$. See Figure 2.

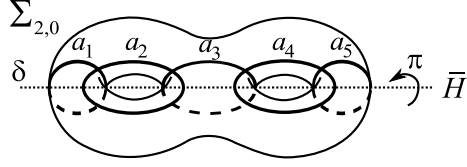

Figure 2: The mapping class H of $\mathcal{M}\text{od}(\Sigma_{2,0})$, represented by the rotation \bar{H} .

- **Cyclic homomorphisms from $\mathcal{M}\text{od}(\Sigma_{2,b})$ in any given group.** A homomorphism from $\mathcal{M}\text{od}(\Sigma_{2,b})$ in any given group, with $b \geq 0$, is said to be *cyclic* if its image is cyclic.
- **Transvection of a homomorphism from the mapping class group in any group**
Let Σ be a genus-2 surface, \mathcal{M} one of the mapping class groups $\mathcal{P}\text{Mod}(\Sigma)$ or $\mathcal{M}\text{od}(\Sigma, \partial\Sigma)$, and G any group. For any homomorphism Ψ from \mathcal{M} to G and for any element g belonging to the centralizer of $\Psi(\mathcal{M})$ in G such that $g^{10} = 1_G$, we will call *transvection of Ψ with direction g* the homomorphism Ψ' that associates $\Psi(T_a)g$ to any Dehn twist T_a along a non-separating curve a .

Previous and new theorems.

So far, the main result about homomorphisms between mapping class groups was given by N.V. Ivanov and J. McCarthy in 1999:

Theorem 2.1 (Ivanov, McCarthy, [IvMc], 1999).

Let Σ be a surface $\Sigma_{g,b}$ and Σ' be a surface $\Sigma_{g',b'}$ with $g \geq 2$ and $(g', b') \neq (2, 0)$, and such that the inequality

$$|(3g - 3 + b) - (3g' - 3 + b')| \leq 1$$

holds. If there exists an injective homomorphism ρ from $\mathcal{M}\text{od}(\Sigma)$ to $\mathcal{M}\text{od}(\Sigma')$, then Σ' is homeomorphic to Σ and ρ is an automorphism induced by a possibly not orientation-preserving diffeomorphism from Σ in Σ' .

They have also completed this theorem by dealing with some cases when $(g', b') = (2, 0)$ or when $g = 1$. When $\Sigma' = \Sigma$, this theorem tells us that the mapping class group is co-Hopfian, that is, any injective endomorphism of $\mathcal{M}\text{od}(\Sigma)$ is an automorphism. The computation of $\text{Out}(\mathcal{M}\text{od}(\Sigma))$ also follows from this theorem.

We turn now to the statements of our theorems. We first deal with the mapping class group relatively to the boundary. Theorem 5 is an existence theorem about nontrivial homomorphisms between mapping class groups. It is completed by Theorem 6 which provides a description of these homomorphisms.

Theorem 5 (Existence of nontrivial homomorphisms from $\mathcal{M}\text{od}(\Sigma, \partial\Sigma)$ to $\mathcal{M}\text{od}(\Sigma', \partial\Sigma')$).

Let Σ be a surface $\Sigma_{g,b}$ and Σ' a surface $\Sigma_{g',b'}$ with $g \geq 2$ and $g' \leq g + 1$.

- When $g = 2$, there exist some cyclic nontrivial homomorphisms from $\mathcal{M}\text{od}(\Sigma_{2,b}, \partial\Sigma_{2,b})$ in any mapping class group admitting a subgroup isomorphic to $\mathbb{Z}/2\mathbb{Z}$, $\mathbb{Z}/5\mathbb{Z}$ or $\mathbb{Z}/10\mathbb{Z}$. When $g \geq 3$, there does not exist any cyclic nontrivial homomorphism.

- When $g \geq 2$, there exist some noncyclic homomorphisms from $\mathcal{M}\text{od}(\Sigma, \partial\Sigma)$ to $\mathcal{M}\text{od}(\Sigma', \partial\Sigma')$ if and only if one of the two following conditions is satisfied: $b \neq 0$ and $g' \geq g$, or $b = 0$ and Σ' is homeomorphic to Σ .

Theorem 6 (Homomorphisms from $\mathcal{M}\text{od}(\Sigma, \partial\Sigma)$ to $\mathcal{M}\text{od}(\Sigma', \partial\Sigma')$).

Let Σ be a surface $\Sigma_{g,b}$ and Σ' a surface $\Sigma_{g',b'}$ with $g \geq 2$ and $g' \in \{g, g+1\}$, and such that $\Sigma' = \Sigma$ if $b = 0$. Any noncyclic homomorphism from $\mathcal{M}\text{od}(\Sigma, \partial\Sigma)$ to $\mathcal{M}\text{od}(\Sigma', \partial\Sigma')$ is a homomorphism induced by the isotopy class of an embedding from Σ in Σ' , or possibly a transvection with direction H (the hyper-elliptic involution of $\mathcal{M}\text{od}(\Sigma_{2,0})$) of such a homomorphism if $g = 2$ and $(g', b') = (2, 0)$. Moreover, if $b = 0$, the homomorphism induced by the isotopy class of an embedding from Σ in Σ' (up to transvection when $\Sigma = \Sigma' = \Sigma_{2,0}$) is an outer conjugation.

Let us now focus on the homomorphisms from $\mathcal{P}\mathcal{M}\text{od}(\Sigma)$ to $\mathcal{P}\mathcal{M}\text{od}(\Sigma')$. In most of the cases, they also can simply be expressed from *homomorphisms induced by an embedding*. Given an isotopy class of an embedding F from Σ in Σ' such that F sends the boundary components of Σ on some boundary components of Σ' or on some trivial curves of Σ' (*trivial* means here isotopic to a point), we can define a homomorphism Ad_F from $\mathcal{P}\mathcal{M}\text{od}(\Sigma)$ to $\mathcal{P}\mathcal{M}\text{od}(\Sigma')$ exactly like we defined the homomorphism $\widehat{\text{Ad}}_F$ from $\mathcal{M}\text{od}(\Sigma, \partial\Sigma)$ to $\mathcal{M}\text{od}(\Sigma', \partial\Sigma')$. Such a homomorphism Ad_F will be called *the homomorphism from $\mathcal{P}\mathcal{M}\text{od}(\Sigma)$ to $\mathcal{P}\mathcal{M}\text{od}(\Sigma')$ induced by the embedding F* . When $\Sigma' = \Sigma$, Ad_F is an automorphism of $\mathcal{P}\mathcal{M}\text{od}(\Sigma)$ that we will call the *outer conjugation by F* . The analogues of Theorems 5 and 6 when each boundary component is fixed only setwise are Theorems 7 and 8.

Theorem 7 (Existence of noncyclic homomorphisms from $\mathcal{P}\mathcal{M}\text{od}(\Sigma)$ to $\mathcal{P}\mathcal{M}\text{od}(\Sigma')$).

Let Σ be a surface $\Sigma_{g,b}$ and Σ' a surface $\Sigma_{g',b'}$ with $g \geq 2$ and $g' \leq g+1$.

- When $g = 2$ and only in this case, there exist some cyclic nontrivial homomorphisms from $\mathcal{P}\mathcal{M}\text{od}(\Sigma_{2,b})$ in any mapping class group that admits a subgroup isomorphic to $\mathbb{Z}/2\mathbb{Z}$, $\mathbb{Z}/5\mathbb{Z}$ or $\mathbb{Z}/10\mathbb{Z}$.
- When $g \geq 2$, there exist some noncyclic homomorphisms from $\mathcal{P}\mathcal{M}\text{od}(\Sigma)$ to $\mathcal{P}\mathcal{M}\text{od}(\Sigma')$ if and only if $g' = g$ and $b' \leq b$.

According to Theorem 7, studying all noncyclic homomorphisms from $\mathcal{P}\mathcal{M}\text{od}(\Sigma)$ to $\mathcal{P}\mathcal{M}\text{od}(\Sigma')$ when $g' \leq g+1$ comes down to studying them when $g' = g$ and $b' \leq b$. This is the aim of Theorem 8 below.

Theorem 8 (Homomorphisms from $\mathcal{P}\mathcal{M}\text{od}(\Sigma)$ to $\mathcal{P}\mathcal{M}\text{od}(\Sigma')$).

Let Σ be a surface $\Sigma_{g,b}$ and Σ' a surface $\Sigma_{g',b'}$ with $g \geq 2$, $g' = g$ and $b' \leq b$. Let Ψ be a noncyclic homomorphism from $\mathcal{P}\mathcal{M}\text{od}(\Sigma)$ to $\mathcal{P}\mathcal{M}\text{od}(\Sigma')$. Then there exists an embedding F from Σ in Σ' such that F sends the boundary components of Σ on some boundary components of Σ' or on some trivial curves of Σ' , and such that Ψ is the homomorphism Ad_F induced by the embedding F , or possibly the transvection by the hyper-elliptic involution H (see the above Figure 2) of the homomorphism Ad_F if $g = 2$ and $(g', b') = (2, 0)$.

Among the homomorphisms between mapping class groups provided by Theorems 6 and 8, let us determine the injective ones.

Theorem 9 (Injections from $\text{Mod}(\Sigma, \partial\Sigma)$ into $\text{Mod}(\Sigma', \partial\Sigma')$).

Let Σ be a surface $\Sigma_{g,b}$ and Σ' a surface $\Sigma_{g',b'}$ with $g \geq 2$ and $g' \leq g+1$. Then, a homomorphism from $\text{Mod}(\Sigma, \partial\Sigma)$ to $\text{Mod}(\Sigma', \partial\Sigma')$ is injective if and only if:

- when $b \neq 0$: if it is induced, up to transvection when $g = 2$, by an embedding F of Σ in Σ' such that F sends the boundary components of Σ on pairwise distinct curves in Σ' ;
- when $b = 0$ and $\Sigma' = \Sigma$: if it is not cyclic (it is then an outer conjugation, or possibly a transvection of an outer conjugation when $g = 2$).

Theorem 10 (Injections of $\mathcal{P}\text{Mod}(\Sigma)$ into $\mathcal{P}\text{Mod}(\Sigma')$).

Let Σ be a surface $\Sigma_{g,b}$ and Σ' a surface $\Sigma_{g',b'}$ with $g \geq 2$ and $g' \leq g+1$. Then, a homomorphism from $\mathcal{P}\text{Mod}(\Sigma)$ to $\mathcal{P}\text{Mod}(\Sigma')$ is injective if and only if the two following conditions hold:

- (i) the surfaces Σ and Σ' are homeomorphic,
- (ii) the homomorphism is an outer conjugation (cf definition page 9), or possibly the transvection with direction H of an outer conjugation when Σ' and Σ are homeomorphic to $\Sigma_{2,0}$.

Comparison with Ivanov and McCarthy's Theorem (cf. Theorem 2.1), 1999.

The proof of Ivanov and McCarthy's Theorem is based on an algebraic characterization of the Dehn twists, which is possible only if the maxima of the ranks of the abelian subgroups of $\text{Mod}(\Sigma)$ and $\text{Mod}(\Sigma')$ differ from at most one. The proof then also requires that the considered homomorphisms are rank-preserving, hence the considered homomorphisms have to be injective.

In this paper, instead of using the rank of abelian subgroups embedded in the mapping class group, we have used homomorphisms from the braid group to the mapping class group. Since these two groups are quite near (see for instance the similarities between braid twists and Dehn twists as generating sets) we get precise results without any injectivity hypothesis. Let us compare the results of Ivanov and McCarthy with ours.

Results of Ivanov and McCarthy (1999) that are not covered in this paper:

- For any nonnegative integer m and for any ε in $\{0, 1\}$, there does not exist any injective homomorphism from $\text{Mod}(\Sigma_{g,b+3m})$ to $\text{Mod}(\Sigma_{g+m,b+\varepsilon})$, where $g \geq 2$ and $b \geq 0$. It is noticeable that the hypotheses allow the genus of the surface at the target to be arbitrary large with respect to the genus of the surface at the source!
- The elements of the considered mapping class groups can permute the boundary components.

Our results (2010) that are not covered by Ivanov and McCarthy's paper:

- Full description of the homomorphisms from $\text{Mod}(\Sigma_{g,b}, \partial\Sigma_{g,b})$ to $\text{Mod}(\Sigma_{g',b'}, \partial\Sigma_{g',b'})$ where $g' < g$ and $g \geq 2$, whatever b and b' are. Precisely, all these homomorphisms are trivial or cyclic.
- Full description of the homomorphisms from $\text{Mod}(\Sigma_{g,b}, \partial\Sigma_{g,b})$ to $\text{Mod}(\Sigma_{g',b'}, \partial\Sigma_{g',b'})$ where $g' = g$ or $g' = g + 1$, and $g \geq 2$, whatever b and b' are. In these cases, there exist noncyclic homomorphisms, and only some of them are injective.

- We also prove these results in a slightly different frame: when the elements of mapping class group preserve each boundary component setwise instead of pointwise.

More precisely, in this paper, we focus on homomorphisms between two mapping class groups associated to the surfaces Σ and Σ' with genera g and g' such that $g \geq 2$ and $g' \leq g + 1$, and whatever their numbers of boundary components are. We shall thus describe the following sets:

- all the homomorphisms from $\mathcal{M}\text{od}(\Sigma, \partial\Sigma)$ to $\mathcal{M}\text{od}(\Sigma', \partial\Sigma')$ (cf. Theorems 5 and 6),
- all the homomorphisms from $\mathcal{P}\mathcal{M}\text{od}(\Sigma)$ to $\mathcal{P}\mathcal{M}\text{od}(\Sigma')$ (cf. Theorems 7 and 8),
- all the injective homomorphisms from $\mathcal{M}\text{od}(\Sigma, \partial\Sigma)$ to $\mathcal{M}\text{od}(\Sigma', \partial\Sigma')$ (cf. Theorem 9),
- all the injective homomorphisms from $\mathcal{P}\mathcal{M}\text{od}(\Sigma)$ to $\mathcal{P}\mathcal{M}\text{od}(\Sigma')$ (cf. Theorem 10).

Like Ivanov and McCarthy, we will mainly show that the nontrivial homomorphisms between mapping class groups are *induced by some embeddings* (the result is however slightly different when the genus of the surface Σ equals 2).

Steps of the proof of Theorems 5 and 6.

Step 1. Let $\Sigma = \Sigma_{g,b}$ and $\Sigma' = \Sigma_{g',b'}$ be two surfaces with $g, g' \geq 2$ and $g' \leq g + 1$, and let Φ be a homomorphism from $\mathcal{M}\text{od}(\Sigma, \partial\Sigma)$ to $\mathcal{M}\text{od}(\Sigma', \partial\Sigma')$. Let $n = 2g + 2$, let ρ_0 be a monodromy homomorphism from \mathcal{B}_n to $\mathcal{M}\text{od}(\Sigma, \partial\Sigma)$. Thus there is a $(2g + 1)$ -chain of curves $(a_i)_{i \leq 2g+1}$ in $\Sigma_{g,b}$ such that for all $i \in \{1, 2, \dots, 2g + 1\}$, we have:

$$\rho_0(\tau_i) = T_{a_i}. \quad (1)$$

Now, let ρ_1 be the composition $\Phi \circ \rho_0$ (see the following commutative diagram).

$$\begin{array}{ccc} \mathcal{M}\text{od}(\Sigma, \partial\Sigma) & \xrightarrow{\Phi} & \mathcal{M}\text{od}(\Sigma', \partial\Sigma') \\ & \swarrow \rho_0 & \searrow \rho_1 \\ & \mathcal{B}_n & \end{array}$$

Then, according to Theorem 2, ρ_1 is either cyclic or is a transvection of monodromy homomorphism.

(i) Suppose first that ρ_1 is cyclic. Then $\Phi(T_{a_1}) = \Phi(T_{a_2}) = \dots$. We can show that the images by Φ of a generating set of Dehn twists of $\mathcal{M}\text{od}(\Sigma, \partial\Sigma)$ agree, so Φ is cyclic. So Φ sends the commutator $[\mathcal{M}\text{od}(\Sigma, \partial\Sigma), \mathcal{M}\text{od}(\Sigma, \partial\Sigma)]$ on 1. But after a theorem of Korkmaz (cf. [Ko2]), the abelianization of $\mathcal{M}\text{od}(\Sigma, \partial\Sigma)$ is trivial when $g \geq 3$, so $[\mathcal{M}\text{od}(\Sigma, \partial\Sigma), \mathcal{M}\text{od}(\Sigma, \partial\Sigma)] = \mathcal{M}\text{od}(\Sigma, \partial\Sigma)$ and Φ is trivial.

(ii) Suppose now that ρ_1 is a transvection of monodromy homomorphism. It means that there exists a triple $((a'_i)_{i \leq 2g+1}, \varepsilon, V)$ such that for all $i \in \{1, 2, \dots, 2g + 1\}$, we have:

$$\rho_1(\tau_i) = T_{a'_i}^\varepsilon V. \quad (2)$$

Notice that g' has to be at least as great as g to allow the existence of the $2g + 1$ chain of curves $(a'_i)_{i \leq 2g+1}$. This proves a large part of Theorem 5.

Step 2. We assume Φ is not cyclic, we consider another $(2g + 1)$ -chain of curves $(c_i)_{i \leq 2g+1}$ in Σ . Then, there exists a triple $((c'_i)_{i \leq 2g+1}, \kappa, W)$ such that for all $i \in \{1, 2, \dots, 2g + 1\}$, we have:

$$\rho_1(\tau_i) = T_{c'_i}^\kappa W. \quad (3)$$

We can show that if a sub-3-chain of curves in $(c_i)_{i \leq 2g+1}$ coincides with a sub-3-chain of curves in $(a_i)_{i \leq 2g+1}$, then $\kappa = \varepsilon$ and $V = W$ in (2) and (3). By showing a result of connectedness related to the set of the $(2g+1)$ -chain of curves in Σ , we deduce that up to an orientation issue, Φ sends each Dehn twist along a non-separating curve a on a Dehn twist along a non-separating curve composed by the same mapping class V independent from a . The orientation issue can be solved by replacing Φ by the composition of Φ by the “outer-conjugation” in $\mathcal{M}\text{od}(\Sigma)$ by a mapping class H lying in $\mathcal{M}\text{od}^\pm(\Sigma)$.

Step 3. Using the fact that there exist special relations with Dehn twists coming from the fact that the abelianization of the mapping class group is trivial, we can deduce that V is trivial. Hence Φ is “twist-preserving”, which means that it sends Dehn twists along non-separating curves on Dehn twists along non-separating curves. Moreover, if a and c meet in 0 or 1 point, then $\Phi(T_a)$ and $\Phi(T_c)$ are two Dehn twists along two curves that meet respectively in 0 or 1 point.

Step 4. If Σ has no boundary, using a minimal generating set of $\mathcal{M}\text{od}(\Sigma)$ consisting in Dehn twists along non-separating curves, the proof would be almost over, but in the general case, this is still far from being the case, since Φ is not supposed to be injective. Indeed, different Dehn twist can be (and sometimes are) sent by Φ on the same Dehn twist. Another big difficulty consists in showing that three Dehn twists cobounding a pair of pants are sent to three Dehn twists cobounding a pair of pants. These problems are solved by translating algebraically these topological issues, involving the existence of special extra curves.

Step 5. Let \mathcal{A} be a set of curves in Σ containing a $(2g+1)$ -chain of curves and containing also additional curves to get a pant decomposition of Σ . It follows from Step 4 that there exists an embedding F from Σ to Σ' such that for any curve a belonging to \mathcal{A} , we have $F(a) = a'$ where a' is such that $\Phi(T_a) = T_{a'}$. We can now compare Φ with the outer conjugation by F and see that they agree.

2.3 Endomorphisms and automorphisms of the mapping class group

We complete the previous subsection by focusing on the injective homomorphisms from $\mathcal{M}\text{od}(\Sigma, \partial\Sigma)$ to $\mathcal{M}\text{od}(\Sigma', \partial\Sigma')$ when $\Sigma' = \Sigma$. In particular, we obtain Ivanov and McCarthy’s theorem stating that $\mathcal{P}\mathcal{M}\text{od}(\Sigma)$ is co-Hopfian (cf. [IvMc]). Theorems 5 and 6 allow us to state an equivalent theorem for $\mathcal{M}\text{od}(\Sigma, \partial\Sigma)$ as well (cf. Theorem 11 below). We will see that when $b = 0$, the group $\mathcal{M}\text{od}(\Sigma, \partial\Sigma)$ satisfies a much stronger property (cf. item (i) of Theorems 11). As in the previous subsection, and since the center of $\mathcal{M}\text{od}(\Sigma_{2,0})$ is nontrivial, the case of the surface $\Sigma_{2,0}$ is special. As it is not central in this paper, we will not recall the remarkable structure of $\text{Aut}(\mathcal{M}\text{od}(2, 0))$ which has been highlighted by McCarthy; the interested reader is referred to [Mc1].

Theorem 11 (Co-Hopfian property of $\mathcal{M}\text{od}(\Sigma, \partial\Sigma)$ and structure of $\text{Aut}(\mathcal{M}\text{od}(\Sigma, \partial\Sigma))$, where $\Sigma \neq \Sigma_{2,0}$).

Let Σ be a surface $\Sigma_{g,b}$ where $g \geq 2$.

- (i) The mapping class group $\mathcal{M}\text{od}(\Sigma, \partial\Sigma)$ is co-Hopfian, that is, the injections are automorphisms.

- (ii) Moreover, when $b = 0$ and $g > 2$ (resp. $b = 0$ and $g = 2$), all the nontrivial (resp. noncyclic) homomorphisms from $\text{Mod}(\Sigma)$ are automorphisms.

From now on, we exclude the case $(g, b) = (2, 0)$ for which the following would be wrong.

- (iii) The map $\text{Ad} : \text{Mod}^\pm(\Sigma) \rightarrow \text{Aut}(\text{Mod}(\Sigma, \partial\Sigma))$ is an isomorphism.
- (iv) The outer automorphism group $\text{Out}(\text{Mod}(\Sigma, \partial\Sigma))$ of $\text{Mod}(\Sigma, \partial\Sigma)$ is isomorphic to the direct product $\mathbb{Z}/2\mathbb{Z} \times \mathfrak{S}_b$, where \mathfrak{S}_b is the symmetric group on b elements.

2.4 Rigidity/triviality of the homomorphisms from $\text{Mod}(\Sigma_{g,0})$ to $\text{Mod}(\Sigma_{g',0})$

Here is a discussion about the exceptional rigidity of the homomorphisms from $\text{Mod}(\Sigma_{g,0})$ to $\text{Mod}(\Sigma_{g',0})$. Let us begin by examining the case where $g = 1$. As always, the case $g = 1$ is special.

Non-cyclicity of $\text{Mod}(\Sigma_{1,0}) \rightarrow \text{Mod}(\Sigma_{g,0})$. We can construct non-cyclic homomorphisms from $\text{Mod}(\Sigma_{1,0})$ to $\text{Mod}(\Sigma_{g,0})$ when $g \not\equiv 0 \pmod{3}$. Here is an example. For any $k \in \mathbb{N}^*$, define an injection φ from \mathcal{B}_3 to \mathcal{B}_{3k} defined as in Figure 3 where for all integers i , Δ_i denotes the

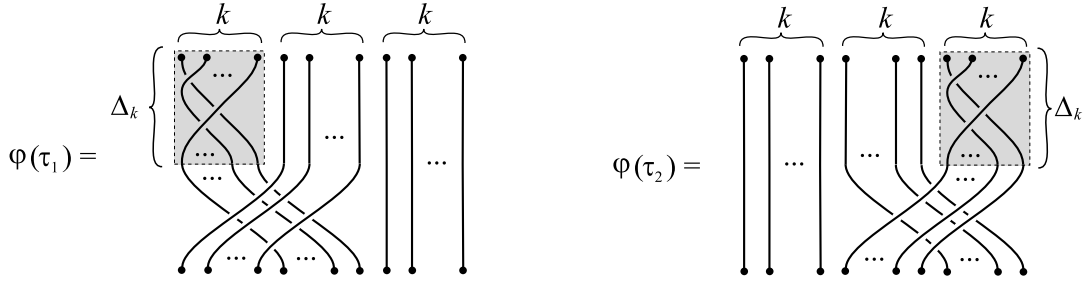

Figure 3: Definition of the homomorphism φ .

Garside element of \mathcal{B}_i . Check that with this definition of φ , we have:

$$\varphi(\Delta_3) = \Delta_{3k}$$

(Hint: in the braid corresponding to $\varphi(\Delta_3)$, each strand crosses all the other strands exactly once). Now, let ψ be the classical monodromy homomorphism from \mathcal{B}_{3k} to $\text{Mod}(\Sigma_{g,b}, \partial\Sigma_{g,b})$ where $(g, b) = (\frac{3k-1}{2}, 1)$ if k is odd and $(g, b) = (\frac{3k-2}{2}, 2)$ if k is even. We denote by d or by d_1 and d_2 the boundary curve(s) of Σ , depending on the parity of k . Then $\psi(\Delta_{3k}^4) = T_d$ if k is odd and $\psi(\Delta_{3k}^2) = T_{d_1}T_{d_2}$ if k is even. Gluing a disk along d , or gluing disks along d_1 and d_2 induces a canonical homomorphism $\text{sq} : \text{Mod}(\Sigma_{g,b}, \partial\Sigma_{g,b}) \rightarrow \text{Mod}(\Sigma_{g,0})$ whose kernel contains the subgroup $\langle \psi(\Delta_{3k}^4) \rangle$ of $\psi(\mathcal{B}_{3k})$. Since $\varphi(\Delta_3) = \Delta_{3k}$, it follows that Δ_3^4 belongs to the kernel of $\text{sq} \circ \psi \circ \varphi$. But $\text{Mod}(\Sigma_{1,0})$ is isomorphic to the quotient of \mathcal{B}_3 by the relation $\Delta_3^4 = 1$, so the homomorphism $\text{sq} \circ \psi \circ \varphi$ induces a well defined homomorphism from $\text{Mod}(\Sigma_{1,0})$ to $\text{Mod}(\Sigma_{g,0})$ for any integer $g \in \{\frac{3k-1}{2}, k \in 2\mathbb{N} + 1\} \cup \{\frac{3k-2}{2}, k \in 2\mathbb{N}\}$, that is, for any g coprime with 3. Thus we have shown the following proposition.

Proposition 2.2 (Non-cyclicity of $\text{Mod}(\Sigma_{1,0}) \rightarrow \text{Mod}(\Sigma_{g,0})$ for all g coprime with 3).

For any g coprime with 3, there exist homomorphisms from $\text{Mod}(\Sigma_{1,0})$ to $\text{Mod}(\Sigma_{g,0})$ that are non-cyclic. \square

However, as far as we know, the existence of non-cyclic (and even nontrivial) homomorphisms from $\mathcal{M}\text{od}(\Sigma_{g,0})$ to $\mathcal{M}\text{od}(\Sigma_{g',0})$ seems to be exceptional as the following results tend to let us think.

Triviality of $\mathcal{M}\text{od}(\Sigma_{g,0}) \rightarrow \mathcal{M}\text{od}(\Sigma_{g',0})$ when $g \geq 3$ and $g' < g$. This is a theorem due to Harvey and Korkmaz [HvKo] which is also included in our Theorem 6.

Remember that according to Theorem 11, there are very few homomorphisms from $\mathcal{M}\text{od}(\Sigma_{g,0}) \rightarrow \mathcal{M}\text{od}(\Sigma_{g',0})$ even when $g = g'$:

Rigidity of $\text{End}(\mathcal{M}\text{od}(\Sigma_{g,0}))$ when $g \geq 2$. All non-cyclic (and even only nontrivial if $g \geq 3$) endomorphisms of $\mathcal{M}\text{od}(\Sigma_{g,0})$ are automorphisms.

Triviality of $\mathcal{M}\text{od}(\Sigma_{g,0}) \rightarrow \mathcal{M}\text{od}(\Sigma_{g',0})$ when $g \geq 3$ and $g' > g$. This is an open question outlined in [BkMt] where J. Berrick and M. Mathney conjecture that for any integer $m > 1$, then for all sufficiently large g , the only homomorphism from $\mathcal{M}\text{od}(\Sigma_{g,0})$ to $\mathcal{M}\text{od}(\Sigma_{g+m,0})$ is the trivial homomorphism (see Conjecture 4.5). Their conjecture is inspired by a theorem they shew (see Theorem 4.4), asserting that for any integer $m > 1$, there are infinitely many values of g such that the only homomorphism from $\mathcal{M}\text{od}(\Sigma_{g,0})$ to $\mathcal{M}\text{od}(\Sigma_{g+m,0})$ is the trivial homomorphism. Our Theorem 6 brings the answer (“yes”) to their conjecture when $m = 1$:

Theorem 12. *Triviality of $\mathcal{M}\text{od}(\Sigma_{g,0}) \rightarrow \mathcal{M}\text{od}(\Sigma_{g+1,0})$ for any $g \geq 2$*

For any integer $g \geq 2$, the only homomorphism from $\mathcal{M}\text{od}(\Sigma_{g,0})$ to $\mathcal{M}\text{od}(\Sigma_{g+1,0})$ is the trivial homomorphism. \square

Remark. Notice that according to Proposition 2.2, not only do there exist nontrivial homomorphisms from $\mathcal{M}\text{od}(\Sigma_{1,0})$ to $\mathcal{M}\text{od}(\Sigma_{2,0})$, but even non-cyclic ones.

2.5 Geometric representations of the Artin groups of type D_n, E_6, E_7 and E_8

Let S be a finite set. A *Coxeter matrix over S* is a matrix $M = (m_{\alpha\beta})_{\alpha,\beta \in S}$ indexed by the elements of S such that $m_{\alpha\alpha} = 1$ for all $\alpha \in S$, and $m_{\alpha\beta} = m_{\beta\alpha} \in \{2, 3, 4, \dots, +\infty\}$ for all $\alpha, \beta \in S, \alpha \neq \beta$. A Coxeter matrix is usually represented by its *Coxeter graph* Γ . This (labeled) graph is defined by the following data. The vertices of Γ are the elements of S . Two vertices α, β are joined by an edge if $m_{\alpha\beta} = 3$, and this edge is labeled by $m_{\alpha\beta}$ if $m_{\alpha\beta} \geq 4$. For $\alpha, \beta \in S$ and $m \in \mathbb{Z}_{\geq 2}$ we denote by $w(\alpha, \beta : m)$ the word $\alpha\beta\alpha \dots$ of length m . Define the *Artin group of type Γ* to be the (abstract) group $A(\Gamma)$ presented by:

$$A(\Gamma) = \langle S \mid w(\alpha, \beta : m_{\alpha\beta}) = w(\beta, \alpha, : m_{\alpha\beta}) \text{ for } \alpha \neq \beta \text{ and } m_{\alpha\beta} < +\infty \rangle.$$

If the graph Γ is connected, then $A(\Gamma)$ is said to be *irreducible* (it cannot be written as a nontrivial direct product). A *small-type Artin group* is an Artin group for which all the entries of the associated Coxeter matrix belongs in $\{2, 3\}$. Define the *Coxeter group of type Γ* to be the (abstract) group $W(\Gamma)$ presented by:

$$W(\Gamma) = \langle S \mid \left\{ \begin{array}{l} \alpha^2 = 1 \text{ for all } \alpha \in S \\ w(\alpha, \beta : m_{\alpha\beta}) = w(\beta, \alpha, : m_{\alpha\beta}) \text{ for } \alpha \neq \beta \text{ and } m_{\alpha\beta} < +\infty \end{array} \right. \rangle.$$

An Artin group is said to be of *spherical type* if the associated Coxeter group is finite. In this paper, we are interested by irreducible Artin groups of small spherical type. After a work of

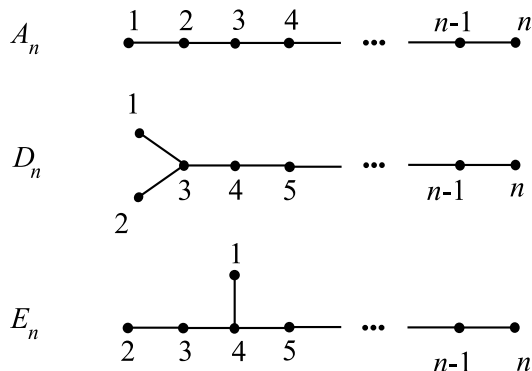

Figure 4: Coxeter Graphs of type A_n , D_n and E_n .

Coxeter (see below), these consist into two infinite families of Artin groups defined by Coxeter graphs A_n and D_n , as well as three exceptional Artin groups defined by Coxeter graphs E_6 , E_7 and E_8 , see Figure 4.

We recognize the group $A(A_n)$ as being the braid group \mathcal{B}_{n+1} with $n + 1$ strands. Artin groups, also called *generalized braid groups*, were first introduced by Tits [Ti] as extensions of Coxeter groups. The finite irreducible Coxeter groups, and therefore the irreducible Artin groups of spherical type, were classified by Coxeter [Cx]. Coxeter groups have been widely studied. Basic references for them are [Bk] and [Hu]. In contrast, Artin groups are poorly understood in general.

The automorphism groups of the (spherical type) Artin groups are beginning to be explored. Artin's 1947 paper [At3] was motivated by the problem of determining the automorphism groups of the braid groups (it is explicit in the introduction). However, the problem itself was only solved 34 years later by Dyer and Grossman [DyGr]. Until now, except for the braid groups (1981), Artin groups of type B_n (see [ChCr], 2005), and Artin groups of rank 2 (see [CrPa2], Theorem 5.1, 2005), the only known significant result on the automorphism groups of spherical type Artin groups has been an extension of Artin's results of [At3] to all irreducible Artin groups of spherical type (see [CoPa], 2003), as well as the computation of the group of the automorphisms of $A(D_n)$ which leave invariant some normal subgroup (it was unknown whether these subgroups were characteristic) (see [CrPa2], Theorem 4.9, 2005).

Geometric representation of the Artin braid group of finite type. From now on, we assume that $A(\Gamma)$ is an small-type Artin group. Let n be the cardinality of S . We denote by $\tau_1, \tau_2, \dots, \tau_n$ the elements of S in accordance with the labeled vertices in Figure 4 and we call them the *standard generators*. Let us consider a collection of annuli $(A_i)_{i \leq n}$. For each $i \leq n$, let a_i be a non contractible curve in $A_i \setminus \partial A_i$. For every couple $(\tau_i, \tau_j) \in S^2$ such that $m_{\tau_i \tau_j} = 3$, we paste together a portion of A_i and a portion of A_j as illustrated on Figure 5. We thus obtain a surface that we denote by $\Sigma(\Gamma)$, together with a special set of curves $(a_i)_{i \leq n}$, see Figure 6. Let n be the cardinality of S . We denote the elements of S by $\tau_1, \tau_2, \dots, \tau_n$ where the subscripts are coherent with the graphs in Figure 4. Then, we have a reference homomorphism ρ_Γ from $A(\Gamma)$ to $\mathcal{M}od(\Sigma(\Gamma), \partial\Sigma(\Gamma))$ given by:

$$\rho_\Gamma : \begin{array}{ccc} A(\Gamma) & \longrightarrow & \mathcal{M}od(\Sigma(\Gamma), \partial\Sigma(\Gamma)) \\ \tau_i & \longmapsto & T_{a_i} \end{array}$$

for all $i \leq n$.

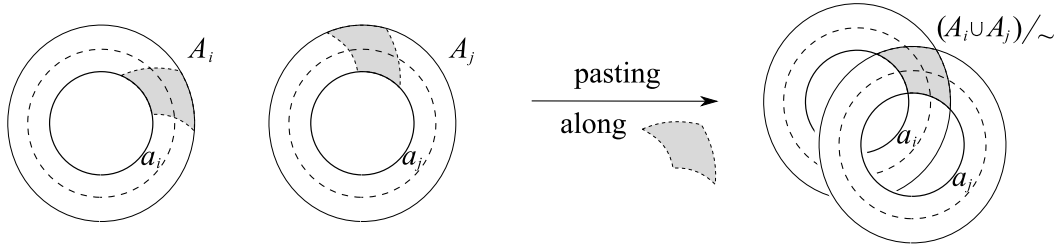

Figure 5: Pasting together two annuli along a portion of each.

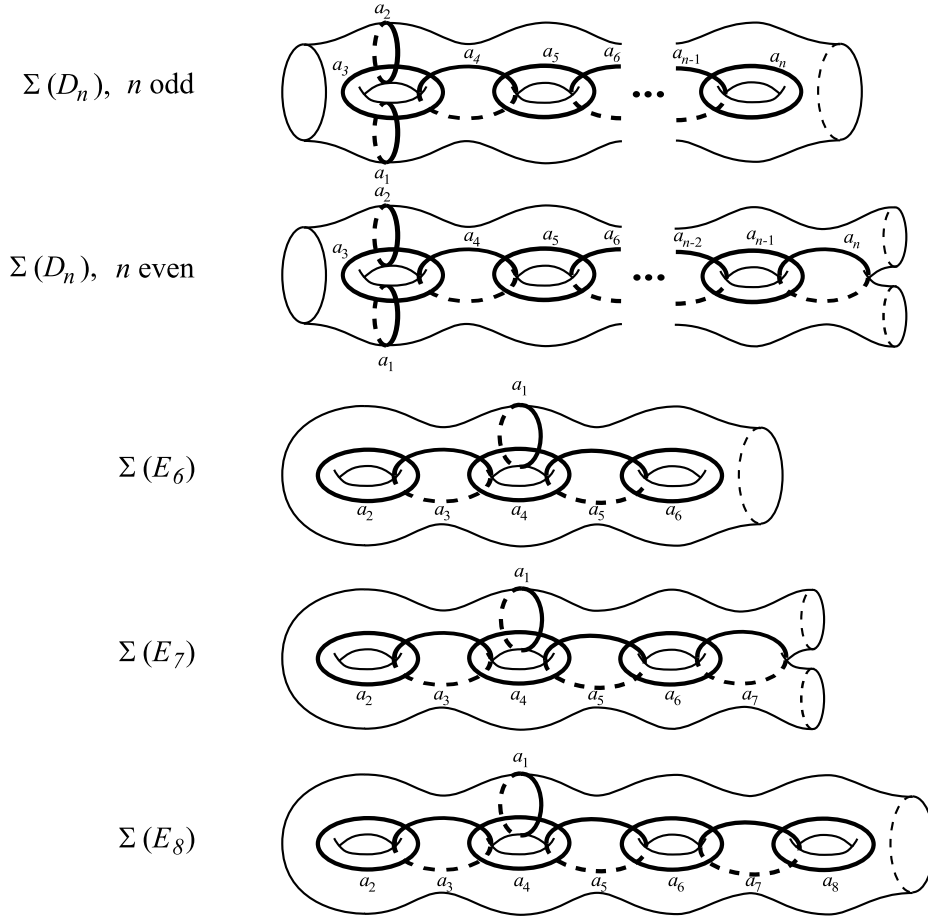

Figure 6: The surface $\Sigma(\Gamma)$ where $\Gamma \in \{D_n ; n \geq 6\} \cup \{E_6, E_7, E_8\}$.

A homomorphism from a small-type Artin group in any group will be said to be *cyclic* if its image is cyclic. Equivalently (thanks to the connectedness of the Coxeter graph), a homomorphism is said to be cyclic if every standard generator is sent on the same element. A *monodromy homomorphism* from $A(\Gamma)$ in the mapping class group of $\Sigma(\Gamma)$ is a homomorphism which sends any two distinct standard generators on two Dehn twists along distinct curves. A homomorphism from $A(D_n)$ in the mapping class group will be said to be a *degenerate monodromy homomorphism* if τ_1 and τ_2 are sent on the same Dehn twist, all other standard generators being sent on Dehn twists on distinct curves. *Transvections* of such homomorphisms are defined as in the

case of the braid group.

The next theorem is redundant with Theorem 2 in case where $\Gamma = A_{n-1}$, and is a direct consequence of Theorem 2 when $\Gamma \in \{D_n, E_n\}$, since according to a theorem of Van der Leek (cf. [VL] and [Pa1]), $A(\Gamma)$ contains $A(A_{n-1})$ as a parabolic subgroup (that is, a subgroup spanned by some of the standard generators of $A(\Gamma)$).

Theorem 13 (Geometric Representations of the irreducible Artin groups of small spherical type).

Let $\Gamma \in \{A_{n-1}, D_n; n \geq 6\} \cup \{E_6, E_7, E_8\}$.

- (i) For any connected surface Σ of genus g , homomorphisms from $A(\Gamma)$ to $\text{Mod}(\Sigma, \partial\Sigma)$ are cyclic if the genus of Σ is less than the genus of $\Sigma(\Gamma)$, that is, if $g < \lfloor \frac{n}{2} \rfloor$ for $\Gamma \in \{A_n, E_n\}$, or if $g < \lfloor \frac{n-1}{2} \rfloor$ for $\Gamma = D_n$.
- (ii) For any connected surface Σ having the same genus as $\Sigma(\Gamma)$, non-cyclic homomorphisms from $A(\Gamma)$ to $\text{Mod}(\Sigma, \partial\Sigma)$ exist. They are transvections of (possibly degenerate in the case of D_n) monodromy homomorphisms. \square

Whereas monodromy representations of $A(\Gamma)$ are known to be faithful for $\Gamma \in \{A_n, D_n\}$ (see [BiHi] and [PeVa]), they are not faithful for $\Gamma \in \{E_6, E_7, E_8\}$ (see [W]). Hence Theorem 13 implies the following.

Theorem 14. Geometric representations of $A(E_6)$, $A(E_7)$ and $A(E_8)$ are not faithful. Let $\Gamma \in \{E_6, E_7, E_8\}$. There is no injective homomorphism from $A(\Gamma)$ to $\text{Mod}(\Sigma(\Gamma), \partial\Sigma(\Gamma))$. \square

2.6 Endomorphisms and automorphisms of the Artin groups of type D_n

Remember that the fact the monodromy representations of \mathcal{B}_n are faithful helped us to determine $\text{End}(\mathcal{B}_n)$. In the same way, we can use the fact the monodromy representations of $A(D_n)$ are faithful to compute $\text{End}(A(D_n))$.

Theorem 15 (Endomorphisms and automorphisms of $A(D_n)$).

Let $n \geq 6$.

- (i) The non-cyclic endomorphisms of $A(D_n)$ are the transvections of (possibly degenerate) monodromy homomorphisms.
- (ii) The injective endomorphisms of $A(D_n)$ are the transvections of monodromy homomorphisms.
- (iii) The automorphisms of $A(D_n)$ are the monodromy homomorphisms.
- (iv) $\text{Out}(A(D_n)) \cong \begin{cases} \mathbb{Z}/2\mathbb{Z} & \text{if } n \text{ is odd,} \\ \mathbb{Z}/2\mathbb{Z} \times \mathbb{Z}/2\mathbb{Z} & \text{if } n \text{ is even.} \end{cases}$

(v) The following short exact sequence splits,

$$1 \rightarrow \text{Inn}(A(D_n)) \rightarrow \text{Aut}(A(D_n)) \rightarrow \text{Out}(A(D_n)) \rightarrow 1$$

and the image of a possible section of $\text{Out}(A(D_n))$ to $\text{Aut}(A(D_n))$ is the group spanned by Inv if n is odd, or the group spanned by Inv and θ if n is even, where Inv is the automorphism that sends τ_i to τ_i^{-1} for all $i \in \{1, 2, \dots, n\}$, and θ is the automorphism that swaps τ_1 and τ_2 and that fixes τ_i for all $i \in \{3, 4, \dots, n\}$.

Steps of the proof. Let φ be a non-cyclic endomorphism of $A(D_n)$. Let $\Sigma = \Sigma(D_n)$. We start from the faithful representation $\rho_{D_n} : A(D_n) \rightarrow \mathcal{M}\text{od}(\Sigma, \partial\Sigma)$ (see [PeVa] for the injectivity). Let $\rho = \rho_{D_n} \circ \varphi$ (see the following commutative diagram).

$$\begin{array}{ccc} & A(D_n) & \\ \varphi \swarrow & & \searrow \rho \\ A(D_n) & \xrightarrow{\rho_{D_n}} & \mathcal{M}\text{od}(\Sigma, \partial\Sigma) \end{array}$$

Let \mathcal{B}_n the braid group included in $A(D_n)$ and spanned by τ_i , with $2 \leq i \leq n$. According to Theorem 2, the restriction of ρ to \mathcal{B}_n is a transvection of monodromy homomorphism.

Step 1. The case where $\varphi(\tau_1) = \varphi(\tau_2)$ is easy to deal with. We exclude it, so that $\rho(\tau_1) \neq \rho(\tau_2)$ (since ρ_{D_n} is injective).

Step 2. Using the injectivity of ρ_{D_n} , we show that φ is a transvection of monodromy homomorphism. We show also that if φ is surjective, then the transvection part has to be trivial.

Step 3. We characterize the elements of $\mathcal{M}\text{od}(\Sigma, \partial\Sigma)$ that lie in $\rho_{D_n}(A(D_n))$. They are the ones that lie in $\rho_{A_{n-1}}(A(A_{n-1}))$ after having pasted a disk along the boundary circle of Σ that cobounded a pair of pants with a_1 and a_2 .

Step 4. We compute the normalizer $\mathcal{N}_{\mathcal{M}\text{od}(\Sigma, \partial\Sigma)}(\rho_{D_n}(A(D_n)))$ of $\rho_{D_n}(A(D_n))$ in $\mathcal{M}\text{od}(\Sigma, \partial\Sigma)$.

Step 5. We finally show that ρ_{D_n} induces the following isomorphs:

$$\text{Aut}(A(D_n)) \cong \mathcal{N}_{\mathcal{M}\text{od}^\pm(\Sigma)}(\rho_{D_n}(A(D_n))), \quad (1)$$

$$\text{Inn}(A(D_n)) \cong \mathcal{N}_{\mathcal{P}\mathcal{M}\text{od}(\Sigma)}(\rho_{D_n}(A(D_n))). \quad (2)$$

Step 6. We then easily compute $A(D_n)$ from step 5 and from the following remark.

Remark. From the equality (1) we get a geometric interpretation about the difference between the odd and the even case for the computation of $\text{Out}(A(D_n))$. The automorphism θ corresponds in $\text{Aut}(\mathcal{M}\text{od}(\Sigma, \partial\Sigma))$ to an obvious inner automorphism when n is odd, and to an outer automorphism when n is even, since it has to permute two boundary circles.

Remark. We deduce from Theorem 15 and from Theorem 4.9 in [CrPa2] the answer to a question asked by J. Crisp and L. Paris in [CrPa2]: the kernel of the map $\pi_D : A(D_n) \rightarrow \mathcal{B}_n$ sending τ_1 and τ_2 on τ_1 and sending τ_i on τ_{i-1} for all $i \geq 3$, which is a free group of rank $n - 1$, happens to be a characteristic subgroup of $A(D(n))$.

Proof of Theorems 2 and 3

3 On monodromy homomorphisms

3.1 Cyclic homomorphisms, monodromy homomorphisms and transvections

Definitions of Cyclic homomorphisms, monodromy homomorphisms and transvections were given in Subsection 2.2. Here are some basic facts related to each of them.

Lemma 3.1 (Criterion 1 for a homomorphism to be cyclic).

Let n be an integer greater than or equal to 5, G any group and φ a homomorphism from \mathcal{B}_n to G . If there exist two distinct integers i and j in $\{1, 2, \dots, n-1\}$ and an nonzero integer k such that $\varphi(\tau_i^k) = \varphi(\tau_j^k)$, then

$$\varphi(\tau_1^k) = \varphi(\tau_2^k) = \dots = \varphi(\tau_{n-1}^k)$$

If $k = 1$, then φ is a cyclic homomorphism.

Proof. For the simplicity of the proof, we assume that $i = 1$, but the case $i \neq 1$ works in a similar way. We introduce the element $\delta = \tau_1 \tau_2 \dots \tau_{n-1}$ lying in \mathcal{B}_n .

a) If $j = 2$, let us conjugate the equality $\varphi(\tau_1^k) = \varphi(\tau_2^k)$ by δ^ℓ for $\ell \in \{0, \dots, n-3\}$. We get $\varphi(\tau_{1+\ell}^k) = \varphi(\tau_{2+\ell}^k)$ for all ℓ , so the lemma follows.

b) If $j > 2$, then let us assume that $j < n-1$. The case $j = n-1$ works in a similar way. Let us conjugate the equality $\varphi(\tau_1^k) = \varphi(\tau_j^k)$ by $\tau_j \tau_{j+1} \tau_j$. We get $\varphi(\tau_1^k) = \varphi(\tau_{j+1}^k)$, and so $\varphi(\tau_j^k) = \varphi(\tau_{j+1}^k)$. Now, let us conjugate this last equality by δ^{1-j} . We get $\varphi(\tau_1^k) = \varphi(\tau_2^k)$ so we have boiled down to the case a). \square

Lemma 3.2 (Criterion 2 for a homomorphism to be cyclic).

Any homomorphism from \mathcal{B}_n ($n \geq 2$) in an abelian group is cyclic.

Proof. Recall that a homomorphism ρ from a group G in an abelian group A sends $[G, G]$ on 1_A . Hence A is isomorphic to a quotient of the abelianization of G . Since the abelianization of \mathcal{B}_n is infinite cyclic (cf. [Bi]), the lemma follows. \square

Lemma 3.3 (Criterion on the existence of monodromy homomorphisms).

Let n be an integer greater than or equal to 3 and Σ a surface $\Sigma_{g,b}$. There exist monodromy homomorphisms from \mathcal{B}_n to $\mathcal{PMod}(\Sigma)$ if and only if $g \geq \frac{n}{2} - 1$.

Proof. Notice that the existence of monodromy homomorphisms only depends on the existence of $(n-1)$ -chains of curves, and such a chain of curves exists if and only if $g \geq \frac{n}{2} - 1$. \square

The following lemma shows how transvections arise naturally from central exact sequences of groups. Such sequences are frequent between mapping class groups. See for instance Proposition ??.(iv)-(vi).

Lemma 3.4 (Criterion for two homomorphisms to be transvections the one of the other). *Let $1 \rightarrow N \rightarrow G \xrightarrow{\psi} \widehat{G} \rightarrow 1$ be a central exact sequence of groups, let n be an integer greater than or equal to 3 and let ρ and ρ' be two homomorphisms from \mathcal{B}_n to G such that $\psi \circ \rho = \psi \circ \rho'$. Then*

(i) ρ' is a transvection of ρ ,

(ii) ρ is cyclic if and only if $\psi \circ \rho$ is cyclic.

Proof. Let us prove item (i). For all integers i in $\{1, \dots, n-1\}$, there exists $g_i \in N$ such that $\rho'(\tau_i) = \rho(\tau_i)g_i$. We have then the following equalities, true for all integers i in $\{1, \dots, n-1\}$:

$$\begin{aligned} \rho'(\tau_i) \rho'(\tau_{i+1}) \rho'(\tau_i) &= \rho(\tau_i) \rho(\tau_{i+1}) \rho(\tau_i) g_i g_{i+1} g_i, \\ \rho'(\tau_{i+1}) \rho'(\tau_i) \rho'(\tau_{i+1}) &= \rho(\tau_{i+1}) \rho(\tau_i) \rho(\tau_{i+1}) g_{i+1} g_i g_{i+1}. \end{aligned}$$

The braid relations in \mathcal{B}_n imply that the four members in these two equalities must be all equal. Therefore for any integer i in $\{1, 2, \dots, n-1\}$, we have:

$$g_i g_{i+1} g_i = g_{i+1} g_i g_{i+1}.$$

But for all i and j in $\{1, 2, \dots, n-1\}$, the elements g_i and g_j commute, so they all are equal. Hence ρ' is a transvection of ρ .

Let us prove now item (ii). If ρ is cyclic, then $\psi \circ \rho$ is cyclic. Conversely, if $\psi \circ \rho$ is cyclic, then it is clear that there exists a cyclic homomorphism ρ' such that $\psi \circ \rho' = \psi \circ \rho$. According to item (i), this implies that ρ is a transvection of ρ' . Hence ρ is cyclic. \square

Homomorphisms of the same nature. Let us say that two homomorphisms ρ_1 and ρ_2 from the braid group to two possibly different mapping class groups are *of the same nature* if they both are cyclic or if they both are transvection of a monodromy homomorphism. Of course, if two homomorphisms are not on the same nature, we shall say that they are *of different nature*.

Let Σ be a surface and let \mathcal{M} be a subgroup of $\text{Mod}(\Sigma)$ or of $\text{Mod}(\Sigma, \partial\Sigma)$. According to their definition, any transvection of monodromy homomorphism from \mathcal{B}_n to \mathcal{M} can be characterized by the data of a $(n-1)$ -chain (a_1, \dots, a_{n-1}) of curves in Σ , of an integer $\varepsilon \in \{\pm 1\}$, and of a mapping class V that commutes with T_{a_i} for all $i \in \{1, \dots, n-1\}$. We are going to show that such a triple $((a_1, \dots, a_{n-1}), \varepsilon, V)$ is unique.

Lemma 3.5. *(Uniqueness of the triple representing a transvection)*

Let n be an integer greater than or equal to 5, let Σ be a surface, and let \mathcal{M} be a subgroup of $\text{Mod}(\Sigma)$ or of $\text{Mod}(\Sigma, \partial\Sigma)$. Let ρ be a transvection of monodromy homomorphism from \mathcal{B}_n to \mathcal{M} such that there exist two triples $((a_1, \dots, a_{n-1}), \varepsilon, V)$ and $((c_1, \dots, c_{n-1}), \eta, W)$ satisfying the following for all $i \in \{1, \dots, n-1\}$:

$$\rho(\tau_i) = T_{a_i}^\varepsilon V = T_{c_i}^\eta W.$$

Then, these two triples are equal.

Proof. Given the properties of V and W , the computation of $\rho(\tau_1 \tau_3^{-1})$ leads to:

$$(T_{a_1} T_{a_3}^{-1})^\varepsilon = (T_{c_1} T_{c_3}^{-1})^\eta.$$

This is an equality between multitwists (for $I(a_1, a_3) = I(c_1, c_3) = 0$), so one of the following cases holds:

- either $\varepsilon = \eta$, $a_1 = c_1$ and $a_3 = c_3$, (2)
- or $\varepsilon = -\eta$, $a_1 = c_3$ and $a_3 = c_1$. (3)

Similarly, the computation of $\rho(\tau_1 \tau_4^{-1})$ leads to one of the following cases:

- either $\varepsilon = \eta$, $a_1 = c_1$ and $a_4 = c_4$, (4)
- or $\varepsilon = -\eta$, $a_1 = c_4$ and $a_4 = c_1$. (5)

The only compatible choice is that (2) and (4) hold. So $\varepsilon = \eta$, and $V = W$. Since for all $i \in \{1, \dots, n-1\}$, we have $T_{a_i}^\varepsilon V = T_{c_i}^\eta W$, we then deduce the equality $T_{a_i} = T_{c_i}$, and eventually the equality $(a_1, a_2, \dots, a_{n-1}) = (c_1, c_2, \dots, c_{n-1})$. \square

According to Lemma 3.5, we can set the following definitions.

Definition 3.6 (Characteristic elements of a transvection of monodromy homomorphism). Let n be an integer greater than or equal to 4, Σ a surface, \mathcal{M} a subgroup of $\text{Mod}(\Sigma)$ or of $\text{Mod}(\Sigma, \partial\Sigma)$. Let ρ be a transvection of monodromy homomorphism from \mathcal{B}_n to \mathcal{M} .

- The *characteristic triple* of ρ is the *unique* triple $((a_1, \dots, a_{n-1}), \varepsilon, V)$ such that for all $i \leq n-1$, we have:

$$\rho(\tau_i) = T_{a_i}^\varepsilon V.$$

- We define:

- the *characteristic $(n-1)$ -chain* of the transvection ρ , as being the $(n-1)$ -chain (a_1, \dots, a_{n-1}) ,
- the *characteristic sign* of the transvection ρ , as being the integer ε ,
- the *direction* of the transvection ρ , as being the mapping class V .

- We denote by $\Sigma(\rho)$ the tubular neighbourhood of $\bigcup_{i \leq n-1} a_i$ where $(a_i)_{i \leq n-1}$ is the characteristic $(n-1)$ -chain of ρ . Notice that $\Sigma(\rho)$ does not necessarily belong to $\mathcal{S}\text{ub}(\Sigma)$, for the boundary components of $\Sigma(\rho)$ can bound some disks in Σ .

- The transvection ρ determines a unique pair (ρ^*, φ) of homomorphisms such that for all $\xi \in \mathcal{B}_n$, we have:

$$\rho(\xi) = \rho^*(\xi)\varphi(\xi),$$

where, for all $i \leq n-1$, we have:

$$\begin{cases} \rho^*(\tau_i) &= T_{a_i}^\varepsilon, \\ \varphi(\tau_i) &= V. \end{cases}$$

The monodromy homomorphism ρ^* and the cyclic homomorphism φ will be called respectively the *monodromy homomorphism* and the *cyclic homomorphism associated to the transvection ρ* .

Thus, the decomposition of a transvection of monodromy homomorphism gives rise to two homomorphisms: a monodromy homomorphism ρ^* determined by a $(n-1)$ -chain of curves and a cyclic homomorphism determined by the direction of the transvection, which is a mapping class V belonging to the centralizer of $\rho^*(\mathcal{B}_n)$ in \mathcal{M} . Therefore the computation of this centralizer is essential. This will be done in Proposition 3.9.

3.2 Proof of Theorem 2

In this subsection, we show the links that exist between the sets $\text{Hom}(\mathcal{B}_n, \mathcal{P}\text{Mod}(\Sigma))$ and $\text{Hom}(\mathcal{B}_n, \text{Mod}(\Sigma, \partial\Sigma))$ cf. Proposition 3.8, and we prove Theorem 2. Proposition 3.8 is actually a corollary of the following lemma.

Lemma 3.7. *Let Σ be a surface with a nonempty boundary. Let F and G be mapping classes in $\mathcal{P}\text{Mod}(\Sigma)$ such that F and G commute. Let \tilde{F} and \tilde{G} be the lifts in $\text{Mod}(\Sigma, \partial\Sigma)$ of respectively F and G . Then \tilde{F} and \tilde{G} commute.*

Proof. Let us start from the following central exact sequence linking $\mathcal{M}\text{od}(\Sigma, \partial\Sigma)$ and $\mathcal{P}\mathcal{M}\text{od}(\Sigma)$:

$$1 \rightarrow \langle T_d, d \in \text{Bndy}(\Sigma) \rangle \rightarrow \mathcal{M}\text{od}(\Sigma, \partial\Sigma) \rightarrow \mathcal{P}\mathcal{M}\text{od}(\Sigma) \rightarrow 1. \quad (*)$$

Then two lifts in $\mathcal{M}\text{od}(\Sigma, \partial\Sigma)$ of a same element of $\mathcal{P}\mathcal{M}\text{od}(\Sigma)$ differ from a central element. Therefore, in order to show the lemma, it is enough to show that, given two elements F and G in $\mathcal{P}\mathcal{M}\text{od}(\Sigma)$ that commute, there exist two lifts \tilde{F} and \tilde{G} of F and G in $\mathcal{M}\text{od}(\Sigma, \partial\Sigma)$ that commute. So we start from two mapping classes F and G in $\mathcal{P}\mathcal{M}\text{od}(\Sigma)$ that commute.

1. Suppose first that F and G are periodic. Since Σ has a nonempty boundary, according to Lemma A.16, F and G span a cyclic group. Therefore there exists $H \in \mathcal{P}\mathcal{M}\text{od}(\Sigma)$ such that F and G are both some powers of H . Let p and q be two integers such that $F = H^p$ and $G = H^q$. Let \tilde{H} be a lift of H in $\mathcal{M}\text{od}(\Sigma, \partial\Sigma)$. Then \tilde{H}^p and \tilde{H}^q are some lifts of F and G that commute.

2. We now turn to the case where F is pseudo-Anosov and G is periodic. Let us denote by \tilde{F} and \tilde{G} some lifts in $\mathcal{M}\text{od}(\Sigma, \partial\Sigma)$ of F and G respectively. Since $F\tilde{G}F^{-1} = G$, there exists a central mapping class $V \in \mathcal{M}\text{od}(\Sigma, \partial\Sigma)$ such that $\tilde{F}\tilde{G}\tilde{F}^{-1} = \tilde{G}V$. Let p be the order of G and let W be the central mapping class of $\mathcal{M}\text{od}(\Sigma, \partial\Sigma)$ such that $\tilde{G}^p = W$. Then, we have on one hand:

$$(\tilde{F}\tilde{G}\tilde{F}^{-1})^p = \tilde{F}\tilde{G}^p\tilde{F}^{-1} = \tilde{F}W\tilde{F}^{-1} = W, \quad (1)$$

and we have on the other hand:

$$(\tilde{F}\tilde{G}\tilde{F}^{-1})^p = (\tilde{G}V)^p = WV^p. \quad (2)$$

When we compare (1) and (2), it comes out that V is trivial for $\mathcal{M}\text{od}(\Sigma, \partial\Sigma)$ is torsion-free. So \tilde{F} and \tilde{G} commute.

3. If F and G are pseudo-Anosov, according to Proposition ??.(iv), there exist two nonzero integers p and q such that $F^p = G^q$. Let ℓ and k be two integers such that $\ell p + kq = p \wedge q = d$. Let us set

- $H = F^k G^\ell$ (so H satisfies $H^p = G^d$ and $H^q = F^d$; hence H is pseudo-Anosov),
- $P = F(H^{-1})^{(q/d)}$ (so $P^d = 1$ and $F \in \langle P, H \rangle$),
- $Q = G(H^{-1})^{(p/d)}$ (so $Q^d = 1$ and $G \in \langle Q, H \rangle$).

According to Lemma A.16, since P and Q are two periodic mapping classes that commute, there exists a mapping class $R \in \langle P, Q \rangle$ such that $\langle P, Q \rangle = \langle R \rangle$. Thus F and G belong to the abelian group spanned by H and R . Then according to step 2., two lifts \tilde{H} and \tilde{R} of H and R in $\mathcal{M}\text{od}(\Sigma, \partial\Sigma)$ span an abelian group, too. Moreover, the latter contains two lifts \tilde{F} and \tilde{G} of F and G in $\mathcal{M}\text{od}(\Sigma, \partial\Sigma)$. In particular, F and G admit two lifts \tilde{F} and \tilde{G} that commute.

4. Let F and G be any two mapping classes of $\mathcal{P}\mathcal{M}\text{od}(\Sigma)$ that commute. Let \mathcal{A} be the set of curves $\sigma(F) \cup \sigma(G)$. Notice that \mathcal{A} is a simplex according to Proposition ??.(iii).

4.a) Let us assume that F and G belong to $\mathcal{P}_{\mathcal{A}}\mathcal{M}\text{od}(\Sigma)$ (i.e. F and G preserve each curve of the set $\mathcal{A} = \sigma(F) \cup \sigma(G)$). We are going to describe for any $H \in \mathcal{P}_{\mathcal{A}}\mathcal{M}\text{od}(\Sigma)$ a construction of a lift of H in $\mathcal{P}_{\mathcal{A}}\mathcal{M}\text{od}(\Sigma, \partial\Sigma)$, then we will apply it to F and G . First, let us consider the following commutative diagram where all the arrows are canonical ($rec_{\mathcal{A}}$ comes from Proposition ??, the three other homomorphisms have been introduced in Subsection ?? Definition ??):

$$\begin{array}{ccccc}
H_3 \in & \mathcal{P}_A \text{Mod}(\Sigma, \partial\Sigma) & \xleftarrow{\text{rec}_A} & \text{Mod}(\Sigma_A, \partial\Sigma_A) & \ni H_2 \\
& \downarrow \text{for}_{\partial\Sigma} & & \downarrow \text{for}_{\partial\Sigma_A} & \\
H_4, H \in & \mathcal{P}_A \text{Mod}(\Sigma) & \xrightarrow{\text{cut}_A} & \mathcal{P} \text{Mod}(\Sigma_A) & \ni H_1, H_5
\end{array}$$

For any $H \in \mathcal{P}_A \text{Mod}(\Sigma)$, let us denote by H_i , $1 \leq i \leq 5$, the following mapping classes, derived from H when following the diagram above:

- $H_1 = \text{cut}_A(H)$, so $H_1 \in \mathcal{P} \text{Mod}(\Sigma_A)$,
- H_2 a lift of H_1 in $\text{Mod}(\Sigma_A, \partial\Sigma_A)$, so $H_2 \in \text{Mod}(\Sigma_A, \partial\Sigma_A)$,
- $H_3 = \text{rec}_A(H_2)$, so $H_3 \in \text{Mod}(\Sigma_A, \partial\Sigma_A)$,
- $H_4 = \text{for}_{\partial\Sigma}(H_3)$, so $H_4 \in \mathcal{P}_A \text{Mod}(\Sigma, \partial\Sigma)$,
- $H_5 = \text{cut}_A(H_4)$, so $H_5 \in \mathcal{P} \text{Mod}(\Sigma_A)$.

The diagram is commutative: $\text{for}_{\partial\Sigma_A} = (\text{cut}_A)(\text{for}_{\partial\Sigma})(\text{rec}_A)$, so $H_1 = H_5$. But we have the following central exact sequence:

$$1 \rightarrow \mathcal{T} \rightarrow \mathcal{P}_A \text{Mod}(\Sigma) \xrightarrow{\text{cut}_A} \mathcal{P} \text{Mod}(\Sigma_A) \rightarrow 1, \quad (**)$$

where $\mathcal{T} = \langle T_d, d \in \mathcal{A} \rangle$. Hence H and H_4 , the preimages of H_1 and H_5 by cut_A , differ from a multitwist along some curves of \mathcal{A} . Hence, up to elements in \mathcal{T} , the mapping class H_3 is a lift of H .

Let us apply this to F and G . As F and G commute, F_1 and G_1 commute. But on each connected component of Σ_A , the restrictions of F_1 and G_1 are periodic or pseudo-Anosov, so we can apply what was shown above in steps 1., 2. and 3., and deduce from it that F_2 and G_2 commute. Hence F_3 and G_3 commute as well. Now, as we just saw it with H , there exist T and T' belonging to \mathcal{T} such that $\tilde{F} = F_3 T$ and $\tilde{G} = G_3 T'$ are some lifts of F and G . Moreover T and T' are central in $\mathcal{P}_A \text{Mod}(\Sigma, \partial\Sigma)$ and in addition, F_3 and G_3 commute, so \tilde{F} and \tilde{G} commute.

4.b) In the general case, if F and G are any two mapping classes that commute, let us denote by \tilde{F} and \tilde{G} some lifts of F and G in $\text{Mod}(\Sigma, \partial\Sigma)$. *A priori*, there exists a multitwist W along the boundary components such that $\tilde{F}\tilde{G}\tilde{F}^{-1} = \tilde{G}W$. Once again, let us set $\mathcal{A} = \sigma(F) \cup \sigma(G)$. Since F and G commute, they preserve globally \mathcal{A} , so there exists a nonzero integer m such that F^m and G^m preserve \mathcal{A} curve-wise. In other words, F^m and G^m belong to $\mathcal{P}_A \text{Mod}(\Sigma)$. So, according to 4.a),

$$\tilde{F}^m \tilde{G}^m \tilde{F}^{-m} = \tilde{G}^m.$$

Now, the equality $\tilde{F}\tilde{G}\tilde{F}^{-1} = \tilde{G}W$ implies that $\tilde{F}\tilde{G}^m\tilde{F}^{-1} = \tilde{G}^m W^m$, then

$$\tilde{F}^m \tilde{G}^m \tilde{F}^{-m} = \tilde{G}^m W^{m^2}.$$

So W^{m^2} is trivial. But $\text{Mod}(\Sigma, \partial\Sigma)$ is torsion-free, hence W is trivial and \tilde{G} and \tilde{F} commute. \square

Proposition 3.8 (Lifting from $\text{Hom}(\mathcal{B}_n, \mathcal{P} \text{Mod}(\Sigma))$ in $\text{Hom}(\mathcal{B}_n, \text{Mod}(\Sigma, \partial\Sigma))$).

Let n be an integer greater than or equal to 3, let Σ be a surface and $\rho : \mathcal{B}_n \rightarrow \mathcal{P} \text{Mod}(\Sigma)$ a homomorphism. Let us recall that we denote by $\text{for}_{\partial\Sigma}$, or for , the canonical epimorphism from $\text{Mod}(\Sigma, \partial\Sigma)$ to $\mathcal{P} \text{Mod}(\Sigma)$. Then:

- (i) There exists a homomorphism $\tilde{\rho} : \mathcal{B}_n \rightarrow \text{Mod}(\Sigma, \partial\Sigma)$ such that $\text{for} \circ \tilde{\rho} = \rho$.

(ii) Such a homomorphism $\tilde{\rho}$ is unique up to transvection, that is, if $\tilde{\rho}_1$ and $\tilde{\rho}_2$ satisfy $\text{for}(\tilde{\rho}_1) = \text{for}(\tilde{\rho}_2) = \rho$, then there exists $V \in \mathcal{M}\text{od}(\Sigma, \partial\Sigma)$ such that V is in the centralizer of $\tilde{\rho}_1(\mathcal{B}_n)$ and of $\tilde{\rho}_2(\mathcal{B}_n)$ and satisfies for all $i \in \{1, \dots, n-1\}$:

$$\tilde{\rho}_2(\tau_i) = \tilde{\rho}_1(\tau_i)V.$$

(iii) Such a homomorphism $\tilde{\rho}$ is cyclic if and only if ρ is cyclic.

(iv) Such a homomorphism $\tilde{\rho}$ is a transvection of monodromy homomorphism if and only if ρ is a transvection of monodromy homomorphism.

Proof.

(i) Let us start from the following central exact sequence:

$$1 \rightarrow \langle T_d, d \in \text{Bndy}(\Sigma) \rangle \rightarrow \mathcal{M}\text{od}(\Sigma, \partial\Sigma) \xrightarrow{\text{for}} \mathcal{P}\mathcal{M}\text{od}(\Sigma) \rightarrow 1. \quad (*)$$

For all $i \in \{1, \dots, n-1\}$, let A_i be a mapping class of $\mathcal{M}\text{od}(\Sigma, \partial\Sigma)$ such that $\text{for}(A_i) = \rho(\tau_i)$. Then for all $i \in \{1, \dots, n-2\}$, we have:

$$\text{for}(A_i A_{i+1} A_i) = \text{for}(A_{i+1} A_i A_{i+1}),$$

hence, according to the exact sequence (*), for all $i \in \{1, \dots, n-2\}$, there exists a multitwist denoted by W_i along some boundary components of Σ such that

$$A_i A_{i+1} A_i = A_{i+1} A_i A_{i+1} W_i.$$

Let us set:

$$\begin{cases} A'_1 := A_1, \\ A'_i := A_i W_1 W_2 \cdots W_{i-1} \text{ when } 2 \leq i \leq n-1. \end{cases}$$

Let us recall that the W_i are central. Hence for all $i \in \{1, \dots, n-2\}$, we have:

$$A'_i A'_{i+1} A'_i = A'_{i+1} A'_i A'_{i+1}.$$

Besides, for all integers i and j smaller than or equal to $n-1$ such that $|i-j| \geq 2$, the mapping classes A_i and A_j commute, so according to Lemma 3.7, the mapping classes A'_i and A'_j commute as well. Finally the map $\tilde{\rho}$ defined by

$$\tilde{\rho}(\tau_i) = A'_i$$

is a homomorphism from \mathcal{B}_n to $\mathcal{M}\text{od}(\Sigma, \partial\Sigma)$. Moreover, by construction, we have $\text{for}(\tilde{\rho}) = \rho$.

(ii) Let $\tilde{\rho}_1$ and $\tilde{\rho}_2$ be two homomorphisms from \mathcal{B}_n to $\mathcal{M}\text{od}(\Sigma, \partial\Sigma)$ that satisfy $\text{for}(\tilde{\rho}_1) = \text{for}(\tilde{\rho}_2)$. According to the central exact sequence (*), we can apply Lemma 3.4: $\tilde{\rho}_2$ is a transvection of $\tilde{\rho}_1$.

(iii) According to Lemma 3.4, $\tilde{\rho}$ is cyclic if and only if ρ is cyclic.

(iv) If $\tilde{\rho}$ is a transvection of monodromy homomorphism, it is clear that $\text{for} \circ \tilde{\rho}$ is still a transvection of monodromy homomorphism. Conversely, suppose that ρ is a transvection of monodromy homomorphism characterized by a triple $((a_i)_{1 \leq i \leq n-1}, \varepsilon, V)$. Let \tilde{V} be a lift of V in $\mathcal{M}\text{od}(\Sigma, \partial\Sigma)$. For all $i \in \{1, \dots, n-1\}$, the mapping class V commutes with T_{a_i} , so V fixes a_i and so does \tilde{V} as well. Hence \tilde{V} commutes with T_{a_i} in $\mathcal{M}\text{od}(\Sigma, \partial\Sigma)$ (we also could have quoted Lemma 3.7). Then we can define $\tilde{\rho}$ as being the transvection of monodromy homomorphism characterized by the triple $((a_i)_{1 \leq i \leq n-1}, \varepsilon, \tilde{V})$. It is clear that $\tilde{\rho}$ is a lifting of ρ . According to step (ii), all liftings of ρ are transvections of $\tilde{\rho}$, therefore all liftings of ρ are transvections of monodromy homomorphisms. \square

Theorem 2 (Homomorphisms from \mathcal{B}_n to $\mathcal{M}\text{od}(\Sigma, \partial\Sigma)$).

Let n be any integer greater than or equal to 6. Let Σ be a surface $\Sigma_{g,b}$ where $g \leq n/2$. Let $\tilde{\rho}$

a homomorphism from \mathcal{B}_n to $\mathcal{M}\text{od}(\Sigma, \partial\Sigma)$. Then $\tilde{\rho}$ is cyclic or is a transvection of monodromy homomorphism. Moreover such transvections of monodromy homomorphisms exist if and only if $g \geq \frac{n}{2} - 1$.

Proof. The second part of Theorem 2 has been proved in Lemma 3.3. It remains to show that all the homomorphisms from \mathcal{B}_n to $\mathcal{M}\text{od}(\Sigma, \partial\Sigma)$ are either cyclic, or transvections of monodromy homomorphisms. Let $\tilde{\rho}$ be a noncyclic homomorphism from \mathcal{B}_n to $\mathcal{M}\text{od}(\Sigma, \partial\Sigma)$. If we compose $\tilde{\rho}$ with the projection $\mathcal{M}\text{od}(\Sigma, \partial\Sigma) \xrightarrow{\text{for}} \mathcal{P}\mathcal{M}\text{od}(\Sigma)$, we get a homomorphism ρ from \mathcal{B}_n to $\mathcal{P}\mathcal{M}\text{od}(\Sigma)$. According to Proposition 3.8.(iii), ρ is not cyclic, so according to Theorem 1, ρ is a transvection of monodromy homomorphism, then according to Proposition 3.8.(iv), $\tilde{\rho}$ is a transvection of monodromy homomorphism. \square

3.3 Centralizer of the monodromy homomorphisms

Proposition 3.9 (Centralizer of the image of a monodromy homomorphism).

Let n be an integer greater than or equal to 5.

Let Σ be a surface $\Sigma_{g,b}$ with $g \geq \frac{n}{2} - 1$.

Let \mathcal{M} be one of the groups $\mathcal{M}\text{od}(\Sigma)$, $\mathcal{P}\mathcal{M}\text{od}(\Sigma)$, or $\mathcal{M}\text{od}(\Sigma, \partial\Sigma)$.

Let $\rho : \mathcal{B}_n \rightarrow \mathcal{M}$ be a monodromy homomorphism with $(a_i)_{i \leq n-1}$ as characteristic chain of curves.

Let $\mathcal{M}^{\Sigma(\rho)}$ be the group of the mapping classes in \mathcal{M} that preserve the subsurface $\Sigma(\rho)$ and that induce the identity in $\mathcal{M}\text{od}(\Sigma(\rho))$. Then:

- (i) the centralizer of $\rho(\mathcal{B}_n)$ in \mathcal{M} is reduced to the group $\mathcal{M}^{\Sigma(\rho)}$, except in the below cases (a), (b) or (c) where it is equal to the group spanned by $\mathcal{M}^{\Sigma(\rho)}$ and by Z , where Z is any extension in $\mathcal{M}\text{od}(\Sigma)$ of the hyper-elliptic mapping class of $\mathcal{M}\text{od}(\Sigma(\rho))$ associated to $(a_i)_{i \leq n-1}$.

Cases (a), (b) and (c) are the following:

(a) the integer n is odd,

(b) the curve simplex $\{a_1, a_3, \dots, a_{n-1}\}$ is non-separating,

(c) $\Sigma_{\{a_1, a_3, \dots, a_{n-1}\}}$ consists in two homeomorphic connected components and $\mathcal{M} = \mathcal{M}\text{od}(\Sigma)$.

- (ii) for any mapping class V belonging to the centralizer of $\rho(\mathcal{B}_n)$ in \mathcal{M} , the mapping class V^2 belongs to $\mathcal{M}^{\Sigma(\rho)}$.

Proof.

Let us show item (i) when n is odd.

It is clear that the group $\mathcal{M}^{\Sigma(\rho)}$ defined in the statement of Proposition 3.9 is in the centralizer of $\rho(\mathcal{B}_n)$. As for the mapping class Z , it preserves each curve a_i by definition, so it lies in the centralizer of $\rho(\mathcal{B}_n)$ as well. Therefore group spanned by $\mathcal{M}^{\Sigma(\rho)}$ and Z is in the centralizer of $\rho(\mathcal{B}_n)$. Conversely, let us show that any element in the centralizer of $\rho(\mathcal{B}_n)$ coincides with an element of $\mathcal{M}^{\Sigma(\rho)}$ possibly composed by Z . In this purpose, let us start from a mapping class F lying in the centralizer of $\rho(\mathcal{B}_n)$. We will first set some definitions in Σ , then we will study F .

a) *Definitions of some curves in Σ .*

For all integers $i \in \{2, 3, \dots, n-1\}$, let us set:

$$\Delta_i = \tau_1(\tau_2\tau_1) \dots (\tau_i\tau_{i-1} \dots \tau_1).$$

For any even i in $\{4, \dots, n-1\}$, let e_i^+ and e_i^- be the two curves such that $\rho(\Delta_{i-1}^2) = T_{e_i^+} T_{e_i^-}$. By induction on the odd integer i in $\{3, \dots, n-2\}$, we define the pairs of pants P_i^+ and P_i^- (cf. Figure 7) in such a way that:

- when $i = 3$, let us denote by P_3^+ and P_3^- respectively the pairs of pants included in Σ whose boundaries are $\{a_1, a_3, e_4^+\}$ and $\{a_1, a_3, e_4^-\}$ respectively,
- when i is an odd integer in $\{5, \dots, n-2\}$ and when P_{i-2}^+ and P_{i-2}^- have been defined, even if it means swapping e_{i+1}^+ and e_{i+1}^- , we can assume that $\{e_{i-1}^+, a_i, e_{i+1}^+\}$ and $\{e_{i-1}^-, a_i, e_{i+1}^-\}$ are the boundary components of two pairs of pants that we denote by P_i^+ and P_i^- respectively.

Let d be the curve such that $\rho(\Delta_{n-1}^4) = T_d$. We denote by P_∂ the pair of pants whose boundary is $\{e_{n-2}^+, e_{n-2}^-, d\}$ (cf. Figure 7). We denote by \mathcal{A}^0 the union of the curves a_i where i is even in $\{2, \dots, n-1\}$, and we denote by \mathcal{A}^1 the union of the curves a_i where i is odd in $\{1, 2, \dots, n-2\}$ and of the curves e_j^+ and e_j^- where j is even in $\{4, \dots, n-1\}$.

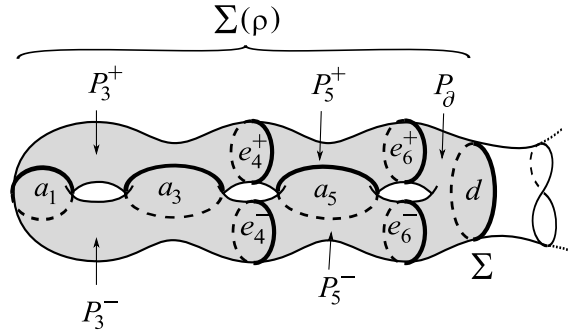

Figure 7: Cutting $\Sigma(\rho)$ in pairs of pants; the curve d and the simplex \mathcal{A}^1 (case where n is odd).

b) *A mapping class F in the centralizer of $\rho(\mathcal{B}_n)$.*

The mapping class F commutes with T_{a_i} for any odd i in $\{1, \dots, n-2\}$, so $F(a_i) = a_i$. The mapping class F commutes also with $T_{e_j^+} T_{e_j^-}$ for any even j in $\{4, \dots, n-1\}$, so $F(\{e_j^+, e_j^-\}) = \{e_j^+, e_j^-\}$. Hence F preserves the set of subsurfaces $\{P_i^+, P_i^-\}$ for any odd i in $\{3, \dots, n-2\}$. Finally, F commutes with T_d for T_d belongs to $\rho(\mathcal{B}_n)$, so F preserves the curve d , preserves the pair of pants P_∂ and preserves the surface $\Sigma(\rho)$ included in Σ with d as boundary, and containing the curve a_1 . Notice that for any odd i in $\{3, \dots, n-4\}$, the pairs of pants P_i^+ and P_{i+2}^+ have e_{i+1}^+ as common boundary component, so the pairs of pants $F(P_i^+)$ and $F(P_{i+2}^+)$ have $F(e_{i+1}^+)$ as common boundary component. Then two situations can happen concerning $F(P_i^+)$ and $F(P_{i+2}^+)$:

- either $F(e_{i+1}^+) = e_{i+1}^+$, and then $F(P_i^+) = P_i^+$ and $F(P_{i+2}^+) = P_{i+2}^+$,
- or $F(e_{i+1}^+) = e_{i+1}^-$, and then $F(P_i^+) = P_i^-$ and $F(P_{i+2}^+) = P_{i+2}^-$.

Finally, by induction, only two situations can happen concerning F :

- First alternative: for all odd integers $i \in \{3, \dots, n-2\}$, $F(P_i^+) = P_i^+$. Then F fixes e_j^+ and e_j^- for all even integers $j \in \{4, \dots, n-1\}$. We define $F' \in \text{Mod}(\Sigma(\rho))$ as being the restriction of F to $\Sigma(\rho)$.

- Second alternative: for any odd i in $\{3, \dots, n-2\}$, we have $F(P_i^+) = P_i^-$. Then for any even j in $\{4, \dots, n-1\}$, the mapping class F swaps e_j^+ and e_j^- . But for any odd i in $\{1, \dots, n-1\}$, the mapping class Z fixes the curves a_i , and for any even j in $\{4, \dots, n-1\}$, the mapping class Z swaps the curves e_j^+ and e_j^- . Hence FZ fixes all the curves of \mathcal{A}^1 . Since F and Z preserve the surface $\Sigma(\rho)$ included in Σ , we can define $F' \in \mathcal{M}\text{od}(\Sigma(\rho))$ as being the restriction of FZ to $\Sigma(\rho)$.

Let us examine F' . The mapping class F' fixes all the curves of \mathcal{A}^1 , hence preserves each subsurface of $\text{Sub}_{\mathcal{A}^1}(\Sigma(\rho))$, which are pairs of pants, and preserves each of their boundary components. So F' induces in $\mathcal{P}\mathcal{M}\text{od}((\Sigma(\rho))_{\mathcal{A}^1})$ a trivial mapping class, where $(\Sigma(\rho))_{\mathcal{A}^1}$ is the surface we get after having cut $\Sigma(\rho)$ along the curves of \mathcal{A}^1 . Then, according to the following exact sequence:

$$1 \rightarrow \langle T_a, a \in \mathcal{A}^1 \rangle \rightarrow \mathcal{P}_{\mathcal{A}^1}\mathcal{M}\text{od}(\Sigma(\rho)) \rightarrow \mathcal{P}\mathcal{M}\text{od}((\Sigma(\rho))_{\mathcal{A}^1}) \rightarrow 1,$$

the mapping class F' is a multitwist along the curves of \mathcal{A}^1 . However, F' commutes with T_a , $a \in \mathcal{A}^0$, so according to Proposition A.2, the curves of \mathcal{A}^0 are reduction curves of F' . But each curve of \mathcal{A}^1 intersects one of the curves of \mathcal{A}^0 , so no curve in \mathcal{A}^1 can be an essential reduction curve of F' . Since F' was to be a multitwist along the curves of \mathcal{A}^1 , it then must be trivial.

Let us come back to the mapping class F . The restriction of F to $\Sigma(\rho)$, or the restriction of FZ to $\Sigma(\rho)$, equals Id in $\mathcal{M}\text{od}(\Sigma(\rho))$. Hence the centralizer of $\rho(\mathcal{B}_n)$ in \mathcal{M} is the group spanned by Z and by $\mathcal{M}^{\Sigma(\rho)}$, the subgroup of \mathcal{M} of the mapping classes inducing the identity mapping class on $\Sigma(\rho)$.

Let us show item (i) when n is even.

The proof is very similar to the odd case. Only the inclusion $\mathcal{Z}_{\mathcal{M}}(\rho(\mathcal{B}_n)) \subset \langle \mathcal{M}^{\Sigma(\rho)}, Z \rangle$. Similarly to the odd case, we first define the following topological objects in $\Sigma(\rho)$, drawn in Figure 8:

- a $(n-1)$ -chain of curves $(a_i)_{1 \leq i \leq n-1}$,
- some curves e_j^+ and e_j^- for any even integer $j \in \{4, \dots, n-2\}$,
- some curves d^+ and d^- ,
- some pairs of pants P_i^+ and P_i^- for any odd integer $i \in \{3, \dots, n-1\}$,
- a set \mathcal{A} of the curves a_i where i is odd in $\{1, \dots, n-1\}$,
- a set \mathcal{A}^1 of the curves of \mathcal{A} and of the curves e_j^+ and e_j^- for any even j in $\{4, \dots, n-2\}$.

Let us start from a mapping class F belonging to the centralizer of $\rho(\mathcal{B}_n)$. Notice that $\Sigma(\rho) = \Sigma(\mathcal{B}_n)$ and let H be the hyper-elliptic mapping class, belonging to $\mathcal{M}\text{od}(\Sigma(\rho))$. The action of H on the curves of \mathcal{A}^1 consists in fixing the curves a_i for any odd i in $\{1, \dots, n-1\}$, in swapping the curves e_j^+ and e_j^- for any even j in $\{4, \dots, n-2\}$, and in swapping the curves d^+ and d^- . As in the odd case, by considering the action of F on the set of pairs of pants of $\text{Sub}_{\mathcal{A}^1}(\Sigma(\rho))$, we see that the restriction of F to $\Sigma(\rho)$ coincides either with H or with the identity of $\Sigma(\rho)$, depending on whether F fixes or swaps the boundary components d^+ and d^- .

Assume that we are in case (a) or (b). Then the mapping class $H \in \mathcal{M}\text{od}(\Sigma(\rho))$ can be extended on Σ . We denote by Z this extension, which is a mapping class of \mathcal{M} . In all the other cases (different from (a) and (b)), the curves d^+ and d^- do not belong to the same orbit under the action of $\mathcal{P}\mathcal{M}\text{od}(\Sigma)$ on $\text{Curv}(\Sigma, \partial\Sigma)$, so in these case, F cannot swap d^+ and d^- and cannot coincide with H on $\Sigma(\rho)$, so F induces in $\mathcal{M}\text{od}(\Sigma(\rho))$ the identity mapping class. To conclude,

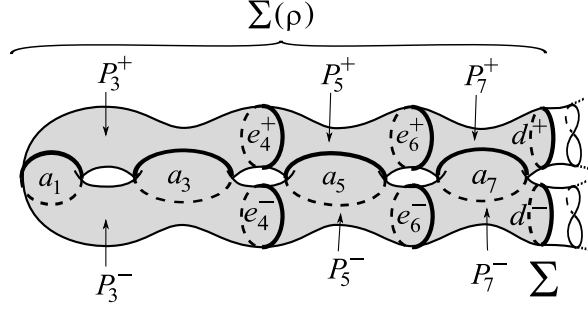

Figure 8: Cutting $\Sigma(\rho)$ in pairs of pants; the curves d^+ , d^- and the simplex \mathcal{A}^1 (case where n is even).

- when one of the conditions (a) or (b) is satisfied, the centralizer of $\rho(\mathcal{B}_n)$ in \mathcal{M} is the group spanned by Z and $\mathcal{M}^{\Sigma(\rho)}$,
- if none of the conditions (a) or (b) is satisfied, the centralizer of $\rho(\mathcal{B}_n)$ in \mathcal{M} is the subgroup $\mathcal{M}^{\Sigma(\rho)}$.

This shows item (i).

Let us show item (ii).

Let V belongs to the centralizer of $\rho(\mathcal{B}_n)$ in \mathcal{M} . We assume that the centralizer of $\rho(\mathcal{B}_n)$ in \mathcal{M} is not reduced to $\mathcal{M}^{\Sigma(\rho)}$ (otherwise, the result is trivial). There exist $\varepsilon \in \{0, 1\}$ and $V' \in \mathcal{M}^{\Sigma(\rho)}$ such that $V = Z^\varepsilon V'$. We assume that $\varepsilon = 1$ (otherwise, the result is trivial). Let us denote by H the mapping class induced by Z on $\Sigma(\rho)$. Notice that Z and V' preserve $\Sigma(\rho)$ and that V' induces the identity on $\Sigma(\rho)$, so $ZV'Z$ preserves $\Sigma(\rho)$ and induces the mapping class $H^2 = \text{Id}$ in $\text{Mod}(\Sigma(\rho))$. So $ZV'Z$ belongs to $\mathcal{M}^{\Sigma(\rho)}$. Now, since $V^2 = (ZV'Z)V'$, it follows that $V^2 \in \mathcal{M}^{\Sigma(\rho)}$. \square

3.4 Proof of Theorem 3

According to Theorems 1 and 2, when the genus of Σ is bounded by $n/2$, the homomorphisms from \mathcal{B}_n in the mapping class group associated to the surface Σ are either cyclic, or are some transvections of monodromy homomorphisms. Consequently, the issue of the injectivity of the homomorphisms from \mathcal{B}_n in the mapping class group is reduced to the issue of the injectivity of the monodromy homomorphisms (cf. Proposition 3.10) and of the transvections of the monodromy homomorphisms (cf. Proposition 3.11), for the cyclic homomorphisms obviously cannot be injective. These different results are gathered in Theorem 3.

Given ρ , a transvection of monodromy homomorphism from \mathcal{B}_n in the mapping class group of a surface Σ , the surface $\Sigma(\rho)$ (described in Definition 3.6) will help us in characterizing the injectivity of the transvections of monodromy homomorphisms.

Proposition 3.10 (Injectivity of the monodromy homomorphisms).

Let $n \geq 6$ and let Σ be any surface. We distinguish the cases $\text{Mod}(\Sigma, \partial\Sigma)$ and $\mathcal{P}\text{Mod}(\Sigma)$.

- (i) A monodromy homomorphism $\tilde{\rho} : \mathcal{B}_n \rightarrow \mathcal{M}\text{od}(\Sigma, \partial\Sigma)$ is injective if and only if we have:
 $\text{Bndy}(\Sigma(\tilde{\rho})) \subset \mathcal{C}\text{urv}(\Sigma, \partial\Sigma)$.

In other words, the boundary components of $\Sigma(\tilde{\rho})$ do not bound any disk in Σ .

- (ii) A monodromy homomorphism $\rho : \mathcal{B}_n \rightarrow \mathcal{P}\mathcal{M}\text{od}(\Sigma)$ is injective if and only if we have:

$$\begin{cases} \text{Bndy}(\Sigma(\rho)) \subset \mathcal{C}\text{urv}(\Sigma, \partial\Sigma), \\ \text{Bndy}(\Sigma(\rho)) \not\subset \text{Bndy}(\Sigma). \end{cases}$$

In other words, the boundary components of $\Sigma(\rho)$ do not bound any disk in Σ and at least one of them is not isotopic to a boundary component of Σ .

Proof.

Let us show item (i).

Let θ be the homomorphism induced by $\tilde{\rho}$ to $\mathcal{M}\text{od}(\Sigma(\tilde{\rho}), \partial\Sigma(\tilde{\rho}))$. According to Theorem A.4, θ is injective. Let ι be the inclusion of $\Sigma(\tilde{\rho})$ in Σ and ι_* the homomorphism induced, going from $\mathcal{M}\text{od}(\Sigma(\tilde{\rho}), \partial\Sigma(\tilde{\rho}))$ into $\mathcal{M}\text{od}(\Sigma, \partial\Sigma)$, so that $\tilde{\rho} = \iota_* \circ \theta$.

- *Necessary condition.* If $\tilde{\rho}$ is injective, then $\tilde{\rho}(\Delta_n^4)$ is not trivial. However when n is odd, $\tilde{\rho}(\Delta_n^4)$ coincides with $T_d^{\pm 1}$ where d is the unique boundary component of $\Sigma(\tilde{\rho})$, hence T_d must be nontrivial. In other words, $d \in \mathcal{C}\text{urv}(\Sigma, \partial\Sigma)$. When n is even, $\tilde{\rho}(\Delta_n^4)$ coincides with $(T_{d_1}T_{d_2})^{\pm 2}$ where d_1 and d_2 are the two boundary components of $\Sigma(\tilde{\rho})$, so at least one of the curves d_1 or d_2 has to be nontrivial. Moreover, if one of them is trivial in Σ , say d_1 for example (cf. Figure 9), then $\iota_* \circ \theta((\tau_{a_1} \dots \tau_{a_{n-2}})^{2(n-1)}) = \iota_* \circ \theta((\tau_{a_1} \dots \tau_{a_{n-1}})^n)$, since $(T_{a_1} \dots T_{a_{n-2}})^{2(n-1)} = (T_{a_1} \dots T_{a_{n-1}})^n = T_{d_2}$. But this contradicts the injectivity of $\tilde{\rho}$, for in \mathcal{B}_n , a product of $n(n-1)$ standard generators can be equal to a product of $2(n-1)(n-2)$ standard generators only if $n(n-1) = 2(n-1)(n-2)$, hence only if $n \in \{1, 4\}$. Therefore, $\{d_1, d_2\} \subset \mathcal{C}\text{urv}(\Sigma, \partial\Sigma)$.

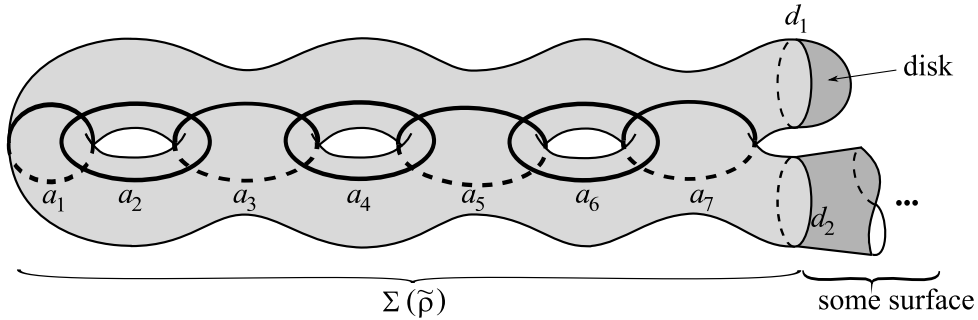

Figure 9: Example with $n = 8$.

- *Sufficient condition.* We assume that $\text{Bndy}(\Sigma(\tilde{\rho})) \subset \mathcal{C}\text{urv}(\Sigma, \partial\Sigma)$. Then according to Theorem A.1, in the case where n is odd, or in the one where n is even and where the two boundary components of $\Sigma(\tilde{\rho})$ are not isotopic in Σ , ι_* is injective. In the case where n is even and where the two boundary components d_1 and d_2 of $\Sigma(\tilde{\rho})$ are isotopic in Σ , according to Theorem A.1 again, we have $\text{Ker}(\iota_*) = \langle T_{d_1}T_{d_2}^{-1} \rangle$. Now, according to Theorem A.4, $\theta(\mathcal{B}_n)$ coincides with $\mathcal{S}\mathcal{M}\text{od}(\Sigma(\tilde{\rho}), \partial\Sigma(\tilde{\rho}))$ whereas $T_{d_1}T_{d_2}^{-1}$ does not belong

to $\mathcal{SMod}(\Sigma(\tilde{\rho}), \partial\Sigma(\tilde{\rho}))$. Hence $\text{Ker}(\iota_*) \cap \text{Im}(\theta) = \{1\}$, so $\iota_*(\theta)$ is injective. Finally, in all the cases, $\iota_* \circ \theta$ is injective, and hence $\tilde{\rho}$, too.

Let us show item (ii).

Again, let θ be the homomorphism induced by ρ to $\text{Mod}(\Sigma(\rho), \partial\Sigma(\rho))$. According to Theorem A.4, θ is injective. Let ι be the inclusion of $\Sigma(\rho)$ in Σ and ι_* the induced homomorphism from $\text{Mod}(\Sigma(\rho), \partial\Sigma(\rho))$ to $\mathcal{PMod}(\Sigma)$, so that $\rho = \iota_* \circ \theta$. The homomorphism ι_* is not necessarily injective.

- *Necessary condition.* As in the case of item (i) with $\tilde{\rho}$, it is necessary that $\text{Bndy}(\Sigma(\rho)) \subset \text{Curv}(\Sigma, \partial\Sigma)$, but since the Dehn twists along boundary components are trivial in $\mathcal{PMod}(\Sigma)$, it is necessary that $\text{Bndy}(\Sigma(\rho)) \not\subset \text{Bndy}(\Sigma)$.
- *Sufficient condition.* Let us assume that $\text{Bndy}(\Sigma(\rho)) \subset \text{Curv}(\Sigma, \partial\Sigma)$ and that $\text{Bndy}(\Sigma(\rho)) \not\subset \text{Bndy}(\Sigma)$, and let us check that ρ is injective. Let us denote by Σ' the complement of $\Sigma(\rho)$ in Σ ; we assume that if a boundary component of $\Sigma(\rho)$ is isotopic to a boundary component of Σ , these two boundary components coincide. With this assumption, all the connected components of Σ' are of negative Euler characteristic. Let $\partial^{\text{inn}}(\Sigma(\rho)) = \partial(\Sigma(\rho)) \setminus \partial\Sigma$. Since $\text{Bndy}(\Sigma(\rho)) \not\subset \text{Bndy}(\Sigma)$, the surface Σ' is nonempty and $\partial^{\text{inn}}(\Sigma(\rho)) \neq \emptyset$. The image of ρ lies in $\mathcal{PMod}(\Sigma, \Sigma')$, which is isomorphic to $\text{Mod}(\Sigma(\rho), \partial^{\text{inn}}(\Sigma(\rho)))$. If $\partial^{\text{inn}}(\Sigma(\rho)) = \partial(\Sigma(\rho))$, Theorem A.4 can be applied and ρ is then injective. This is always what happens in the case when n is odd, but when n is even, it can happen that $\partial^{\text{inn}}(\Sigma(\rho)) = \{d\} \neq \partial(\Sigma(\rho))$, where d is one of the two boundary components of $\Sigma(\rho)$. In this case, $\mathcal{PMod}(\Sigma, \Sigma')$ is isomorphic to $\text{Mod}(\Sigma(\rho), d)$, and ρ induces a homomorphism ς from \mathcal{B}_n to $\text{Mod}(\Sigma(\rho), d)$, which is injective if and only if ρ is injective itself. Let us denote by pr the canonical projection of $\text{Mod}(\Sigma(\rho), \partial\Sigma(\rho))$ to $\text{Mod}(\Sigma(\rho), d)$. Then $\varsigma = pr \circ \theta$. Moreover, we have $\text{Ker}(\varsigma) = \text{Ker}(pr) \cap \theta(\mathcal{B}_n) = \{1\}$, for $\text{Ker}(pr) = \langle T_{d'} \rangle$ where d' is the boundary component of $\Sigma(\rho)$ different from d , but $T_{d'}$ does not belong to $\theta(\mathcal{B}_n)$. Hence ς is injective, so ρ is injective. \square

Proposition 3.11 (Injectivity of the transvections).

(i) *Let n be an integer greater than or equal to 3, G any group, ρ a homomorphism from \mathcal{B}_n to G and ρ_1 a transvection of ρ . If G is torsion-free (for example, if $G = \text{Mod}(\Sigma, \partial\Sigma)$ with $\partial\Sigma \neq \emptyset$), then ρ is injective if and only if ρ_1 is injective.*

(ii) *Let n be an integer greater than or equal to 6 and Σ a surface of genus $g \leq \frac{n}{2}$. Then for any monodromy homomorphism ρ from \mathcal{B}_n to $\mathcal{PMod}(\Sigma)$, any transvection of ρ is injective if and only if ρ is injective.*

Proof. Let ρ be an injective homomorphism from \mathcal{B}_n to G and let ρ_1 be a transvection of ρ . We show by contradiction that ρ_1 is injective, then we will have shown item (i) of Proposition 3.11, for ρ can also be seen as a transvection of ρ_1 . Let us then assume that there exists ξ , a nontrivial element of \mathcal{B}_n such that $\rho_1(\xi) = 1$. Let $\varphi : \mathcal{B}_n \rightarrow G$ the cyclic homomorphism associated to the transvection ρ_1 such that for all $\zeta \in \mathcal{B}_n$, we have $\rho_1(\zeta) = \rho(\zeta)\varphi(\zeta)$. Hence, we have $\rho(\xi) = \varphi(\xi)^{-1}$, but since $\varphi(\xi)$ lies in the centralizer of $\rho(\mathcal{B}_n)$ in G , so does $\rho(\xi)$. But ρ is injective, so ξ belongs to the center of \mathcal{B}_n , that is, ξ is a power of Δ_n^2 . Therefore, there exists a nonzero integer k such that

$$(\rho(\Delta_n)\varphi(\Delta_n))^{2k} = 1. \quad (1)$$

Now, if G is torsion-free, we have $\rho(\Delta_n)\varphi(\Delta_n) = \rho_1(\Delta_n) = 1$. Then, as above, $\varphi(\Delta_n)$ lies in the centralizer of $\rho(\mathcal{B}_n)$ in G , hence so does $\rho(\Delta_n)$. Now, since ρ is injective, Δ_n must belong to the center of \mathcal{B}_n , hence must be a power of Δ_n^2 , which is absurd. This proves item (i) of Proposition 3.11.

• *Let us show the direct implication of item (ii): if ρ is an injective monodromy homomorphism, then the transvection ρ_1 of ρ is injective.*

We are going to show by contradiction that ρ_1 is injective. As above, if ρ_1 is not injective, there exists a nonzero integer k such that (1) holds. Now, Δ_n is a product of $\frac{n(n-1)}{2}$ generators, so $\varphi(\Delta_n^2)$ is the $n(n-1)$ -th power of a mapping class V belonging to the centralizer of $\rho(\mathcal{B}_n)$ in $\mathcal{PMod}(\Sigma)$. Let us denote by W the mapping class V^2 . According to Proposition 3.9, W lies in $\mathcal{M}^{\Sigma(\rho)}$, where $\mathcal{M}^{\Sigma(\rho)}$ is the group of the mapping classes in $\mathcal{PMod}(\Sigma)$ that preserve $\Sigma(\rho)$ and that induce the identity in $\mathcal{PMod}(\Sigma(\rho))$. So we have $\varphi(\Delta_n^2) = W^{\frac{n(n-1)}{2}}$, and hence, with (1), we get:

$$W^{kn\frac{n(n-1)}{2}} = \rho(\Delta_n^{-2k}). \quad (2)$$

Now, if n is odd, then $\rho(\Delta_n^4) = T_d^{\pm 1}$ where d is the unique boundary component of $\Sigma(\rho)$, whereas if n is even, then $\rho(\Delta_n^2) = (T_{d_1}T_{d_2})^{\pm 1}$ where d_1 and d_2 are the two boundary components of $\Sigma(\rho)$. So the mapping class W lying in $\mathcal{M}^{\Sigma(\rho)}$ satisfies:

$$\begin{cases} W^{kn(n-1)} = T_d^{\mp k}, & \text{if } n \text{ is odd, where } \{d\} = \text{Bndy}(\Sigma(\rho)); \\ W^{\frac{kn(n-1)}{2}} = (T_{d_1}T_{d_2})^{\mp k}, & \text{if } n \text{ is even, where } \{d_1, d_2\} = \text{Bndy}(\Sigma(\rho)). \end{cases} \quad (3)$$

Let us recall that since ρ is injective by assumption, then according to Proposition 3.10, at least one of the boundary components of $\Sigma(\rho)$ is not trivial in Σ , hence the mapping classes T_d in case a) and $T_{d_1}T_{d_2}$ in case b) are not trivial.

Let us that (3) leads to a contradiction. The curve d is a separating curve of Σ . Let us call Σ' the connected component of Σ_d different from $\Sigma(\rho)$. According to Proposition ??.(i), $\mathcal{PMod}(\Sigma, \Sigma(\rho))$ is isomorphic to $\mathcal{PMod}(\Sigma', d)$. The mapping class W can thus be seen as a periodic mapping class in $\mathcal{PMod}(\Sigma', d)$. Let us call m its period. According to Lemma A.14, there exists an integer p coprime with m such that $W^m = T_d^p$, so the equality $W^{kn(n-1)} = T_d^{\mp k}$ implies $W^{n(n-1)} = T_d^{\mp 1}$. Therefore the period of W is $n(n-1)$, so it is greater than or equal to 42 since $n \geq 7$. But $\Sigma(\rho)$ is of genus $\frac{n}{2} - 1$ and Σ is of genus at most $\frac{n}{2}$ hence Σ' is of genus at most 1. But there does not exist any nontrivial periodic mapping class in a genus-0 surface whose boundary components are fixed, according to Corollary A.9, and the order of periodic mapping classes on a genus-1 surface with a nonempty boundary and whose boundary components are fixed is bounded by 6, according to Corollary A.12. This is a contradiction.

Let us show that (4) leads also to a contradiction. If Σ is the gluing of $\Sigma(\rho)$ on itself by identifying both of its boundary components d_1 and d_2 and if we call d the image of d_1 in Σ , then $\mathcal{M}^{\Sigma(\rho)}$ is the cyclic group spanned by T_d , so there exists an integer m such that $W = T_d^m$. But on the other hand, $W^{\frac{kn(n-1)}{2}} = (T_{d_1}T_{d_2})^{\mp k} = T_d^{\mp 2k}$, whence $(T_d^m)^{\frac{kn(n-1)}{2}} = T_d^{\mp 2k}$. This is absurd, for T_d is not a torsion element. Now, if we assume that d_1 and d_2 are two distinct curves in $\text{Curv}(\Sigma, \partial\Sigma)$, we know that at least one is not a boundary component of Σ . Notice that V used to preserve $\{d_1, d_2\}$, so W (which is equal to V^2) preserves d_1 and d_2 . Finally, as previously in case a), W can be seen as a periodic mapping class of period at least 15 (for $\frac{n(n-1)}{2}$)

equals at least 15 when $n \geq 6$), on a surface of genus zero or one. As explained above, this is absurd.

- *Let us show the reverse implication of item (ii): if ρ is a non-injective monodromy homomorphism, then the transvection ρ_1 of ρ is not injective either.*

Let ρ be a non-injective monodromy homomorphism from \mathcal{B}_n to $\mathcal{PMod}(\Sigma)$ and let ρ_1 be a transvection of ρ . Let us show that ρ_1 is not injective. According to Proposition 3.10.(ii), it can exist several reasons for ρ not being injective. We distinguish two cases, whether $\text{Bndy}(\Sigma(\rho)) \cap \mathcal{Curv}(\Sigma)$ is empty or not.

If $\text{Bndy}(\Sigma(\rho)) \cap \mathcal{Curv}(\Sigma)$ is empty, then $\mathcal{M}^{\Sigma(\rho)}$ is trivial. Hence according to Proposition 3.9, when n is odd, the centralizer of $\rho(\mathcal{B}_n)$ is spanned by $\rho(\Delta_n^2)$ which is of order 2, and when n is even, this centralizer is trivial. So, in both cases, we have $\rho_1(\Delta_n^4) = 1$, and ρ_1 is not injective.

If $\text{Bndy}(\Sigma(\rho)) \cap \mathcal{Curv}(\Sigma)$ is not empty, whereas ρ is not injective, then necessarily, n is even and the boundary component of $\text{Bndy}(\Sigma(\rho))$ that is not in $\mathcal{Curv}(\Sigma)$ bounds a disk. In this case, we are going to exhibit two elements of \mathcal{B}_n that do not commute although their images do. This will show that ρ_1 is not injective. Let us set $\Delta_{n-2} = \tau_1(\tau_2\tau_1) \dots (\tau_{n-2}\tau_{n-3} \dots \tau_1)$. We have seen in the proof of Proposition 3.10 that in our situation, we have $\rho(\Delta_n^2) = \rho(\Delta_{n-2}^4)$ (cf. Figure 9). Hence in particular $\rho(\Delta_{n-2}^4)$ commutes with $\rho(\tau_{n-1})$, so $\rho_1(\Delta_{n-2}^4)$ commutes with $\rho_1(\tau_{n-1})$. But Δ_{n-2}^4 do not commute with τ_{n-1} . Therefore, ρ_1 is not injective. \square

Now, Theorem 3 is a direct corollary from Theorems 1 and 2, and from Propositions 3.10 and 3.11.

Proof of Theorem 1

We turn now to the proof Theorem 1. The proof ends in Section 10. We first prove it when n is an even number. We will deduce from it in Subsection 10.4 the case when n is odd. Throughout Sections 4 - 10, we will introduce the following pieces of notation. We gather them here for later reference.

Summary of the upcoming notation

- n is an *even* integer greater than or equal to 6,
 g and b are nonnegative integers such that $2 - 2g - b \leq -1$ and $g \leq \frac{n}{2}$,
 ρ is a given homomorphism from \mathcal{B}_n to $\mathcal{PMod}(\Sigma_{g,b})$,
from Section 7 on, ρ will be assumed to be noncyclic;

- τ_i where $i \in \{1, 2, \dots, n-1\}$ is the i^{th} standard generator of \mathcal{B}_n .

Δ_n is the *Garside-element* of \mathcal{B}_n , and δ is the “ $\frac{1}{n}$ -flip” of \mathcal{B}_n . They are defined by:

$$\begin{aligned}\Delta_n &= \tau_1(\tau_2\tau_1)(\tau_3\tau_2\tau_1)\dots(\tau_{n-1}\tau_{n-2}\dots\tau_1), \\ \delta &= \tau_1\tau_2\dots\tau_{n-1},\end{aligned}$$

and satisfy the following well-known properties:

- for all integers $i \in \{1, 2, \dots, n-1\}$, we have $\Delta_n \tau_i = \tau_{n-i} \Delta_n$;
- for all integers $i \in \{1, 2, \dots, n-2\}$, we have $\delta \tau_i = \tau_{i+1} \delta$, and $\delta^2 \tau_{n-1} = \tau_1 \delta^2$;
- the element $\Delta_n^2 = \delta^n$ span the center of \mathcal{B}_n .

In section 6, we define an n^{th} “standard” generator of \mathcal{B}_n , namely $\tau_0 = \delta\tau_{n-1}\delta^{-1}$. When the subscript i satisfies $i < 0$ or $i > n-1$, τ_i is the j^{th} standard generator of \mathcal{B}_n where j is the remainder of the euclidian division of i by n ;

- A_i is defined by $A_i = \rho(\tau_i)$ for all integers i ,
 \mathcal{G} is the set $\{A_1, A_2, \dots, A_{n-1}\}$ and \mathcal{G}_0 is the set $\{A_0, A_1, \dots, A_{n-1}\}$,
 $\text{Odd}(n)$ is the set $\{1, 3, \dots, n-1\}$ of the $\frac{n}{2}$ first odd integers,
 \mathcal{X} the set $\{A_i, i \in \text{Odd}(n)\}$ and \mathcal{Y} the set $\{A_i, i \in \{1, 2, \dots, n-1\} \setminus \text{Odd}(n)\}$;
- $\sigma(\mathcal{G}_0)$ is the union $\bigcup_{i \leq n-1} \sigma(A_i)$ and $\sigma(\mathcal{X})$ is the union $\bigcup_{i \in \text{Odd}(n-1)} \sigma(A_i)$.
- We have a natural action from \mathcal{B}_n on $\mathcal{PMod}(\Sigma)$ by conjugation via ρ given by:

$$\xi.A = \rho(\xi)A\rho(\xi)^{-1}.$$

We will introduce the subgroups $\mathcal{J} = \langle \delta \rangle$ and $\mathcal{H} = \langle \gamma_i, i \in \text{Odd}(n) \rangle$ of \mathcal{B}_n where $\gamma_i = \tau_i\tau_{i+1}\tau_i\tau_{i+2}\tau_{i+1}\tau_i$ for all $i \in \text{Odd}(n)$. Then the action of \mathcal{B}_n on $\mathcal{PMod}(\Sigma)$ induces an action of \mathcal{J} on \mathcal{G}_0 and an action of \mathcal{H} on \mathcal{X} .

Outline of the proof of Theorem 1

Section 4:

A curve a of $\sigma(\mathcal{G})$ is a *peripheral curve* if a is a separating curve with the following property: one of the connected components of Σ_a is of genus 0. Let $\sigma_p(\mathcal{G})$ be the set of *peripheral curves*. We show that up to transvection, we can assume that $\sigma_p(\mathcal{G})$ is empty, which is a first way to simplify the study of $\sigma(\mathcal{G})$. From Section 5 on, we will assume that $\sigma_p(\mathcal{G})$ is empty. We also show in section 4 that in many cases, we can assume without loss of generality that Σ is a surface without boundary.

Section 5:

We show that, although $\sigma_p(\mathcal{G})$ is assumed to be empty, if ρ is not cyclic, then $\sigma(\mathcal{G})$ is nonempty. From Section 7 on, we will assume that ρ is not cyclic, so that $\sigma(\mathcal{G})$ is nonempty.

Section 6:

We introduce an n^{th} generator $\tau_0 = \delta\tau_{n-1}\delta^{-1}$ to the standard presentation of the braid group in order to get a cyclic action of the subgroup of \mathcal{B}_n spanned by δ on the set of the generators $\{\tau_0, \tau_1, \dots, \tau_{n-1}\}$. This action will be fundamental in the next sections.

Section 7:

We prove that there exists a partition of $\sigma(\mathcal{G}_0)$ in two sets of curves: $\sigma_s(\mathcal{G}_0)$ and $\sigma_n(\mathcal{G}_0)$, both of them satisfying each interesting properties. For instance, for any curve a of $\sigma_s(\mathcal{G}_0)$, there exists a unique $i \in \{0, 1, \dots, n-1\}$ such that $a \in \sigma(A_i)$. As for the set of curves $\sigma_n(\mathcal{G}_0)$, it is stable by the action of \mathcal{B}_n induced by ρ on $\text{Curv}(\Sigma)$.

Section 8:

We show that $\sigma(\mathcal{G}_0)$ contains only non-separating curves.

Section 9:

We describe the set of curves $\sigma(\mathcal{X})$ in the surface Σ .

Section 10:

We gather the results of the previous sections and we show that ρ is a transvection of monodromy homomorphism: Theorem 1 when n is even is shown. Finally, we deduce from it Theorem 1 in the general case.

4 On geometric representations of \mathcal{B}_n in nonempty-boundary surfaces

This section is divided into two parts.

- In Subsection 4.1, we are interested by homomorphisms from the braid group in the mapping class group of genus-0 surfaces. We are going to prove that all homomorphisms from \mathcal{B}_n to $\mathcal{PMod}(\Sigma_{0,b})$ are cyclic, see Theorem 4.4.

- In Subsection 4.2, we are interested by homomorphisms from the braid group to the mapping class group of a surface of genus $g \geq 1$ with $b \geq 2$ boundary components. Given such a homomorphism ρ , we focus on some special separating curves related to ρ which will be called *peripheral curves*. Three propositions will be useful for the remainder of the paper, namely:

- Proposition 4.5 (on the stability of peripheral curves),
- Proposition 4.7 (on “getting rid of” peripheral curves),
- Proposition 4.9 (on “getting rid of” the boundary).

The two last propositions will follows from the first one. Moreover, Proposition 4.9 utilizes Theorem 4.4.

4.1 Geometric representations of \mathcal{B}_n in genus-0 surfaces are cyclic

We are going to use the fact that some mapping class groups are *bi-orderable*.

Definition 4.1 (Bi-orderable group). A group G is *bi-orderable* if there exists a linear ordering \leq on G invariant by left and right multiplications (namely, if $f \leq g$, then $h_1 f h_2 \leq h_1 g h_2$ for all $f, g, h_1, h_2 \in G$). In what follows, we will denote by \leq the ordering of all the bi-orderable groups that we are going to meet, and by $<$ the strict order associated to \leq .

Proposition 4.2. *Any homomorphism from \mathcal{B}_n in a bi-orderable group is cyclic.*

Proof. Let G be an orderable group and let φ be a homomorphism from B_n to G . Let us assume that $\varphi(\tau_1) < \varphi(\tau_2)$. Let γ be the element $\tau_1\tau_2\tau_1$. Then $\varphi(\gamma\tau_1\gamma^{-1}) < \varphi(\gamma\tau_2\gamma^{-1})$. Since $\gamma\tau_1\gamma^{-1} = \tau_2$ and $\gamma\tau_2\gamma^{-1} = \tau_1$ we have $\varphi(\tau_2) < \varphi(\tau_1)$, which is absurd. In the same way, assuming that $\varphi(\tau_2) < \varphi(\tau_1)$ leads to a contradiction. Hence $\varphi(\tau_1) = \varphi(\tau_2)$, so φ is cyclic. \square

Thanks to Proposition 4.3 below, we will be able to apply Proposition 4.2 to the mapping class groups and so prove Theorem 4.4.

Proposition 4.3 (Bonatti, Paris).

For any genus-0 surface Σ , the mapping class group $\text{Mod}(\Sigma, \partial\Sigma)$ is bi-orderable. \square

As a corollary, we get:

Theorem 4.4 (Homomorphisms from \mathcal{B}_n to $\text{Mod}(\Sigma_{0,b}, \partial\Sigma_{0,b})$ and to $\mathcal{P}\text{Mod}(\Sigma_{0,b})$).

Let Σ be a genus-0 surface. For all integers n greater than or equal to 3, any homomorphism from \mathcal{B}_n to $\text{Mod}(\Sigma, \partial\Sigma)$, respectively to $\mathcal{P}\text{Mod}(\Sigma)$, is cyclic.

Proof. Any homomorphism from \mathcal{B}_n to $\text{Mod}(\Sigma, \partial\Sigma)$ is cyclic, for according to Proposition 4.3, $\text{Mod}(\Sigma, \partial\Sigma)$ is bi-orderable. As for the homomorphisms from \mathcal{B}_n to $\mathcal{P}\text{Mod}(\Sigma)$, according to Proposition 3.8, they can be lifted in homomorphisms from \mathcal{B}_n to $\text{Mod}(\Sigma, \partial\Sigma)$, which are cyclic. Hence again, according to Proposition 3.8, the homomorphisms from \mathcal{B}_n to $\mathcal{P}\text{Mod}(\Sigma)$ are cyclic. \square

4.2 Peripheral curves

Starting point for the next sections.

- Let n be an even number greater than or equal to 6, let $\Sigma = \Sigma_{g,b}$ where $g \geq 1$ and $b \geq 2$.
- Let ρ be a homomorphism from \mathcal{B}_n to $\mathcal{P}\text{Mod}(\Sigma)$.
- For all integers $i \leq n-1$, $\rho(\tau_i)$ will be denoted by A_i .
- We denote by \mathcal{G} the set $\{A_1, A_2, \dots, A_{n-1}\}$.

We aim to get as much information as possible concerning $\sigma(A)$ for all $A \in \mathcal{G}$.

Peripheral curves, $\sigma_p(\mathcal{G})$.

A curve a of $\sigma(\mathcal{G})$ is said to be *peripheral* if it separates Σ in two connected components and if the genus of one of them is zero (cf. Figure 10). The set of peripheral curves will be denoted by $\sigma_p(\mathcal{G})$. We will denote by $\sigma_p(A)$ the set of curves $\sigma_p(\mathcal{G}) \cap \sigma(A)$.

The mapping class group $\mathcal{P}_{\mathcal{A}}\text{Mod}(\Sigma)$

Remember that if \mathcal{A} is a curve simplex in $\text{Curv}(\Sigma)$, we define $\mathcal{P}_{\mathcal{A}}\text{Mod}(\Sigma)$ as the subgroup of $\mathcal{P}\text{Mod}(\Sigma)$ consisting on all mapping classes that fixes each curve of \mathcal{A} and that preserve each subsurface of $\text{Sub}_{\mathcal{A}}(\Sigma)$. If $\mathcal{A} = \{a\}$, then we write $\mathcal{P}_a\text{Mod}(\Sigma)$ instead of $\mathcal{P}_{\{a\}}\text{Mod}(\Sigma)$.

Proposition 4.5 (Stability of peripheral curves).

- (i) *We have the equalities: $\sigma_p(A_1) = \sigma_p(A_2) = \dots = \sigma_p(A_{n-1}) = \sigma_p(\mathcal{G})$.*
- (ii) *We have the inclusion: $\rho(\mathcal{B}_n) \subset \mathcal{P}_{\sigma_p(\mathcal{G})}\text{Mod}(\Sigma)$.*

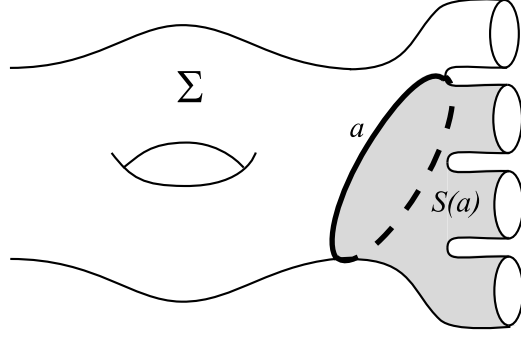

Figure 10: Example of peripheral curve.

Lemma 4.6. *Let x be a peripheral curve. If a mapping class F in $\mathcal{PMod}(\Sigma)$ verifies $I(F(x), x) = 0$, then F lies in $\mathcal{P}_x\text{Mod}(\Sigma)$.*

Proof of Lemma 4.6. Let S be the holed sphere bounded by x . Since $I(F(x), x) = 0$, if $F(x)$ is distinct from x , then either $F(x)$ is in S and $F(S)$ is included in S , or $F(x)$ is outside of S and S is included in $F(S)$ (recall that $\text{Bndy}(F(S)) \cap \text{Bndy}(\Sigma) = \text{Bndy}(S) \cap \text{Bndy}(\Sigma)$ for F belongs to $\mathcal{PMod}(\Sigma)$). Since S and $F(S)$ are homeomorphic, these two hypotheses are absurd. Finally, $F(x) = x$. Moreover, S and $F(S)$ are located on the same side of x , so F does not swap the two side-neighbourhoods of x . \square

Proof of Proposition 4.5.

(i) Let A and C be two mapping classes of \mathcal{G} that commute, x a curve of $\sigma_p(A)$ and Z a mapping class such that $ZAZ^{-1} = C$. Then $Z(x) \in \sigma_p(C)$, and since $AC = CA$, we have $I(\sigma(A), \sigma(C)) = 0$, so $I(x, Z(x)) = 0$. Now, according to Lemma 4.6 which we apply to the curve x and the mapping class Z , we get $Z(x) = x$, and hence $x \in \sigma(C)$. This shows that for all $i, j \in \{1, 2, \dots, n-1\}$ such that $|i - j|_n > 1$, we have $\sigma_p(A_i) = \sigma_p(A_j)$. We then easily can deduce that

$$\sigma_p(A_1) = \sigma_p(A_2) = \dots = \sigma_p(A_{n-1}) = \sigma_p(\mathcal{G}).$$

(ii) For all $x \in \sigma_p(\mathcal{G})$, all $A \in \mathcal{G}$, we have just seen that $x \in \sigma(A)$, so $I(x, A(x)) = 0$, hence according to Lemma 4.6, $A(x) = x$ and A does not swap the two connected components of Σ_x . Hence A belongs to $\mathcal{P}_x\text{Mod}(\Sigma)$. Since \mathcal{G} span $\rho(\mathcal{B}_n)$, this proves the second part of Proposition 4.5. \square

Proposition 4.7 (Killing the peripheral curves).

Let Σ' be the connected component of nonzero genus of $\Sigma_{\sigma_p(\mathcal{G})}$. Then:

- (i) For all $\xi \in \mathcal{B}_n$, $\rho(\xi)$ induced a mapping class in $\mathcal{PMod}(\Sigma')$ that we denote by $\rho'(\xi)$. The obtained map $\rho' : \mathcal{B}_n \rightarrow \mathcal{PMod}(\Sigma')$ is a homomorphism.
- (ii) The homomorphisms ρ and ρ' are of the same nature: one is cyclic (respectively is a transvection of monodromy homomorphism) if and only if the other is.

Proof.

(i) Let Σ' be the connected component of nonzero genus of $\Sigma_{\sigma_p(\mathcal{G})}$ and let \mathcal{U} be the subset of curves of $\sigma_p(\mathcal{G})$ that bound the subsurface of Σ isomorphic to Σ' . According to Proposition

4.5 on the stability of the peripheral curves, $\rho(\mathcal{B}_n)$ is included in $\mathcal{P}_U\text{Mod}(\Sigma)$. Let us denote by π' the homomorphism from $\mathcal{P}\text{Mod}(\Sigma_U)$ to $\mathcal{P}\text{Mod}(\Sigma')$. Then $\rho' = \pi' \circ \text{cut}_U \circ \rho$, so ρ' is indeed a homomorphism.

(ii) According to Proposition 3.8, there exists a lift $\tilde{\rho}'$ of ρ' in $\text{Hom}(\mathcal{B}_n, \text{Mod}(\Sigma', \partial\Sigma'))$, which is of the same nature as ρ' . For all $\xi \in \mathcal{B}_n$, if we extend the mapping class $\tilde{\rho}'(\xi)$ by the identity on Σ , and if we then postcompose it by the canonical “forget” homomorphism $\text{for}_{\partial\Sigma} : \text{Mod}(\Sigma, \partial\Sigma) \rightarrow \mathcal{P}\text{Mod}(\Sigma)$, we get a homomorphism ρ_1 from \mathcal{B}_n to $\mathcal{P}\text{Mod}(\Sigma)$ such that $\pi' \circ \text{cut}_U \circ \rho_1 = \rho'$. By construction, ρ_1 is of the same nature as ρ' .

Let Σ'' be the union of the subsurfaces of $\text{Sub}_U(\Sigma)$ distinct from Σ' . Let us denote by π'' the homomorphism from $\mathcal{P}\text{Mod}(\Sigma_U)$ to $\mathcal{P}\text{Mod}(\Sigma'')$. According to Theorem 4.4, $\pi'' \circ \text{cut}_U \circ \rho$ is a cyclic homomorphism. Let W be the mapping class $\pi'' \circ \text{cut}_U \circ \rho(\tau_1)$ of $\mathcal{P}\text{Mod}(\Sigma'')$ and \widetilde{W} the mapping class $\rho(\tau_1)(\rho_1(\tau_1))^{-1}$ of $\mathcal{P}\text{Mod}(\Sigma, \Sigma')$. Notice that \widetilde{W} induces W on $\mathcal{P}\text{Mod}(\Sigma'')$. Let ρ_2 be the transvection of ρ_1 with direction \widetilde{W} (i.e. for all integers i in $\{1, 2, \dots, n-1\}$, we have $\rho_2(\tau_i) = \rho_1(\tau_i)\widetilde{W}$). Notice that ρ_2 and ρ_1 are of the same nature, so ρ_2 and ρ' are of the same nature.

On the other hand, we have the following central exact sequence:

$$1 \rightarrow \langle T_u, u \in U \rangle \rightarrow \mathcal{P}_U\text{Mod}(\Sigma) \xrightarrow{\text{cut}_U} \mathcal{P}\text{Mod}(\Sigma_U) \rightarrow 1.$$

Since $\text{cut}_U \circ \rho_2 = \text{cut}_U \circ \rho$, it comes that, according to Lemma 3.4, ρ_2 is a transvection of ρ , hence ρ_2 and ρ are of the same nature.

Finally, ρ' and ρ are of the same nature. □

Definition 4.8 (The “squeeze map” of a surface with a nonempty boundary).

Starting from the surface $\Sigma_{g,b}$ with $b > 0$, let $\Sigma_{g,0}$ be the surface without boundary obtained from $\Sigma_{g,b}$ by squeezing each boundary component to a point. We get a surface which exceptionally can be a sphere or a torus. There is a canonical surjective continuous map from $\Sigma_{g,b}$ to $\Sigma_{g,0}$ that we will denote by $\text{sq} : \Sigma_{g,b} \rightarrow \Sigma_{g,0}$. The map sq induces a canonical homomorphism between mapping class groups that we denote by:

$$\text{sq}^* : \mathcal{P}\text{Mod}(\Sigma_{g,b}) \rightarrow \text{Mod}(\Sigma_{g,0}).$$

Proposition 4.9. *Let \mathcal{A} be a curve simplex and \mathcal{K} a subgroup of $\mathcal{P}\text{Mod}(\Sigma)$ such that \mathcal{A} is \mathcal{K} -stable and such that the cardinality of any curve orbit in \mathcal{A} under the action of \mathcal{K} is at least 3. Then the canonical surjective continuous map $\text{sq} : \Sigma \rightarrow \Sigma_{g,0}$ induces an isomorphism from the graph $\Gamma(\Sigma, \mathcal{A})$ (cf. Definition ??) to the graph $\Gamma(\Sigma_{g,0}, \text{sq}(\mathcal{A}))$. In particular, the cardinality of $\text{Sub}_{\mathcal{A}}(\Sigma)$ is smaller than or equal to $2g-2$, and the cardinality of \mathcal{A} is smaller than or equal to $3g-3$. Moreover, for any mapping class $F \in \mathcal{K}$, for any curve $a \in \mathcal{A}$ and for any subsurface $S \in \text{Sub}_{\mathcal{A}}(\Sigma)$, we have:*

$$\begin{aligned} \text{sq}(F(a)) &= \text{sq}^*(F)(\text{sq}(a)), \\ \text{sq}(F(S)) &= \text{sq}^*(F)(\text{sq}(S)). \end{aligned}$$

Proof.

1. Let us show that no subsurface of $\text{Sub}_{\mathcal{A}}(\Sigma)$ can be sent by sq on a sphere minus one or two disks. Hence no curve of \mathcal{A} is sent on a contractible curve by sq , and for any two curves of \mathcal{A} , they cannot be sent on the same isotopy class in Σ' . Once we have shown this, we have shown that the sets \mathcal{A} and $\text{sq}(\mathcal{A})$ of curves have the same cardinality.

a) By assumption, the set \mathcal{A} does not contain any fixed point under the action of \mathcal{K} . So \mathcal{A} does not contain any peripheral curve, according to Lemma 4.6. Hence no subsurface of $\text{Sub}_{\mathcal{A}}(\Sigma)$ can be sent by sq on a sphere minus a disk. Therefore, no curve of \mathcal{A} is sent on a contractible curve.

b) Let us show that no subsurface of $\text{Sub}_{\mathcal{A}}(\Sigma)$ can be sent by sq on a sphere minus two disks, which is equivalent to say that for any two curves of \mathcal{A} , they cannot be sent on the same isotopy class in Σ' . If there did exist two distinct curves a and a' of \mathcal{A} such that $\text{sq}(a) = \text{sq}(a')$, then it would exist in $\text{Sub}_{\mathcal{A}}(\Sigma)$ a genus-0 subsurface S whose boundary would consist in some boundary components included in $\partial\Sigma$ and exactly two boundary components a and a' that do not belong to $\text{Bndy}(\Sigma)$. But any mapping class of $\mathcal{P}\text{Mod}(\Sigma)$ which globally preserves \mathcal{A} should preserve the surface S , since $\text{Bndy}(S) \cap \text{Bndy}(\Sigma)$ is not empty, and hence should preserve the pair $\{a, a'\}$. This is in contradiction with our hypotheses, since the cardinality of the orbit of a under the action of \mathcal{K} must be greater than or equal to 3.

According to a) and b), the cardinalities of the sets \mathcal{A} and $\text{sq}(\mathcal{A})$ are equal.

2. Since \mathcal{A} and $\text{sq}(\mathcal{A})$ have the same cardinality, the map sq induces a graph isomorphism Ψ from the graph $\Gamma(\Sigma, \mathcal{A})$ to the graph $\Gamma(\Sigma_{g,0}, \text{sq}(\mathcal{A}))$. Moreover, as the map sq and the homomorphism sq^* are canonical, the action of \mathcal{K} on $\Gamma(\Sigma, \mathcal{A})$ induces an action of $\text{sq}^*(\mathcal{K})$ on $\Gamma(\Sigma_{g,0}, \text{sq}(\mathcal{A}))$ and the expected commutation properties hold. \square

5 Irreducible geometric representations of \mathcal{B}_n

Hypotheses.

Let $n \geq 6$ an even number, let $\Sigma = \Sigma_{g,b}$ with $g \leq \frac{n}{2}$, and let $\rho : \mathcal{B}_n \rightarrow \mathcal{P}\text{Mod}(\Sigma)$ such that:

- ρ is non-cyclic by assumption,
- $\sigma_p(\mathcal{G}) = \emptyset$ by assumption, inspired by Proposition 4.7.

Remember that for all integers i , $\rho(\tau_i)$ will be denoted by A_i ; and the set $\{A_1, A_2, \dots, A_{n-1}\}$ will be denoted by \mathcal{G} .

Irreducible homomorphisms, periodic homomorphisms, pseudo-Anosov homomorphisms

In \mathcal{B}_n , the standard generators are conjugate, so their images by ρ are all reducible, all periodic or all pseudo-Anosov. We will say that ρ is an *irreducible homomorphism from \mathcal{B}_n* if $\rho(\tau_1)$ is an *irreducible mapping class*, that is, if $\sigma(\rho(\tau_1)) = \emptyset$. If $\rho(\tau_1)$ is periodic (respectively pseudo-Anosov), we will say that ρ is *periodic* (respectively *pseudo-Anosov*).

To prove Theorem 1, we need to prove that, up to an element in the centralizer of \mathcal{G} , the elements of \mathcal{G} are Dehn Twists. In this purpose, focusing on $\sigma(\mathcal{G})$ will be efficient, but we first need to prove that $\sigma(\mathcal{G})$ is not empty! This is precisely the aim of this section, whose main theorem is the following.

Theorem 5.1. *Any irreducible homomorphism from \mathcal{B}_n to $\mathcal{P}\text{Mod}(\Sigma)$ is cyclic.*

We will distinguish the case of the periodic homomorphisms (cf. propositions 5.6 and 5.7) from the one of the pseudo-Anosov homomorphisms (cf. Proposition 5.8). The proof of this theorem is short when Σ has a nonempty boundary but the involved methods are inefficient when the boundary of Σ is empty. When $\partial\Sigma = \emptyset$, we argue by contradiction: we assume that

ρ is not cyclic, we exhibit a finite subgroup of $\rho(\mathcal{B}_n)$ and we show that its cardinality exceeds the theoretical maximal cardinality of a finite subgroup of $\text{Mod}(\Sigma)$.

In the first subsection, we present some results on the relations in $\rho(\mathcal{B}_n)$, which will be useful to fix a lower bound to the cardinality of some subgroups of $\rho(\mathcal{B}_n)$. The second and third subsections (5.2 and 5.3) are devoted to the proof of Theorem 5.1 in the case of the periodic homomorphisms and of the pseudo-Anosov homomorphisms, respectively.

5.1 Cardinalities of some abelian subgroups of $\rho(\mathcal{B}_n)$

- Let φ be a homomorphism from \mathcal{B}_n in some group. For any element ξ in \mathcal{B}_n , we write $\bar{\xi}$ instead of $\varphi(\xi)$.

- For all even positive integers positif N , let us denote by $\text{Odd}(N) = \{1, 3, \dots, N-1\}$ the set of odd positive integers smaller than N . Let r be the integer $\frac{n}{2}$. Thus $\text{Odd}(n)$ contains the r first odd positive integers.

- Let \mathcal{L}_n be the free abelian subgroup $\langle \tau_i, i \in \text{Odd}(n) \rangle_{\mathcal{B}_n}$ of \mathcal{B}_n . The group \mathcal{L}_n is isomorphic to \mathbb{Z}^r .

The aim of this subsection is to study the algebraic structure of the abelian group $\varphi(\mathcal{L}_n)$, that is to say to study the structure of the quotients of \mathcal{L}_n , cf. Lemma 5.3, and then to compute the cardinality of $\varphi(\mathcal{L}_n)$, cf. Lemma 5.5. Let us begin by stating an elementary case that was already proved, see Lemma 3.1.

Lemma 5.2. *If there exist two distinct integers i and j smaller than or equal to $n-1$ and a nonzero integer ℓ such that $\bar{\tau}_i^\ell = \bar{\tau}_j^\ell$, then we have:*

$$\bar{\tau}_1^\ell = \bar{\tau}_2^\ell = \dots = \bar{\tau}_{n-1}^\ell. \quad \square$$

Lemma 5.3. *There exist four nonnegative integers M, m, d, s such that the group $\varphi(\mathcal{L}_n)$ is isomorphic to the quotient of \mathcal{L}_n by the three following relations:*

$$\tau_1^M = \tau_3^M = \dots = \tau_{n-1}^M = 1, \quad \text{R1}(M)$$

$$\tau_1^m = \tau_3^m = \dots = \tau_{n-1}^m, \quad \text{R2}(m)$$

$$(\tau_1 \tau_3 \dots \tau_{2r-1})^d = \tau_1^s. \quad \text{R3}(d, s)$$

When M is nonzero, m and d are also nonzero and the integers M, m, d, s satisfy the following divisibility relations:

- m divides M ;
- d divides m and m divides s ;
- M divides $(r - \frac{s}{d})m$.

Finally, $d = 1$ if and only if φ is cyclic (that is to say, if $m = 1$).

Remark. In the following subsection, we will apply this lemma to the image of ρ where ρ will be a homomorphism from \mathcal{B}_n in a mapping class group. The integer M will be then the order of $\rho(\tau_1)$ and the integer m will be the order of $\rho(\tau_1 \tau_3^{-1})$.

Proof.

0. Before starting, notice that if we choose $M = m = d = s = 0$, the quotient of \mathcal{L}_n by $(\text{R1}(0), \text{R2}(0), \text{R3}(0, 0))$ is equal to \mathcal{L}_n .

1. Let us show that any relation that holds in $\varphi(\mathcal{L}_n)$ is equivalent to a set of relations of type R1, R2 and R3.

Since \mathcal{L}_n is abelian, any relation in $\varphi(\mathcal{L}_n)$ can be written as follows:

$$\bar{\tau}_1^{k_1} \bar{\tau}_3^{k_3} \dots \bar{\tau}_{n-1}^{k_{n-1}} = 1, \quad (1)$$

where the k_i , $i \in \text{Odd}(n)$, are not all zero. We are going to show that relation (1) is equivalent to a set of relations of type R1(M), R2(m), R3(d, s) where M, m, d, s are some integers. We distinguish three cases: a), b) and c) below.

a) If the k_i are all equal, (1) is exactly the relation R3($k_1, 0$).

b) Suppose now that the k_i are not all equal. Let us consider the differences $|k_i - k_j|$, $i, j \in \text{Odd}(n)$. They are not all zero. Let us assume for example that $k_1 - k_3 \neq 0$. Then after having conjugated (1) by $\bar{\tau}_1 \bar{\tau}_2 \bar{\tau}_1 \bar{\tau}_3 \bar{\tau}_2 \bar{\tau}_1$, we get:

$$\bar{\tau}_3^{k_1} \bar{\tau}_1^{k_3} (\bar{\tau}_5^{k_5} \dots \bar{\tau}_{n-1}^{k_{n-1}}) = 1. \quad (2)$$

Now, if we compare (1) and (2), we have:

$$\bar{\tau}_1^{k_1} \bar{\tau}_3^{k_3} = \bar{\tau}_3^{k_1} \bar{\tau}_1^{k_3}, \quad (3)$$

whence $\bar{\tau}_1^{k_1 - k_3} = \bar{\tau}_3^{k_1 - k_3}$, and hence, according to Lemma 5.2:

$$\bar{\tau}_1^{|k_1 - k_3|} = \bar{\tau}_2^{|k_1 - k_3|} = \dots = \bar{\tau}_{n-1}^{|k_1 - k_3|}. \quad (4)$$

We repeat this argument for all the pairs $(i, j) \in \text{Odd}(n)^2$, $i \neq j$. Let p be the greatest common divisor of $\{|k_i - k_j|, i, j \in \text{Odd}(n)\}$. We get relation (5), which is equal to R2(p):

$$\bar{\tau}_1^p = \bar{\tau}_2^p = \dots = \bar{\tau}_{n-1}^p. \quad (5)$$

For all $i \in \text{Odd}(n)$, the euclidian division of k_i by p provides two integers q_i and k'_i such that

$$k_i = q_i p + k'_i \text{ where } 0 \leq k'_i < p.$$

Since the k_i , $i \in \text{Odd}(n)$, differ one from the other by a multiple of p , the k'_i , $i \in \text{Odd}(n)$, are all equal. Let us call k' this integer. Thanks to relation (5), relation (1) implies:

$$\bar{\tau}_1^{k'} \bar{\tau}_3^{k'} \dots \bar{\tau}_{n-1}^{k'} = \bar{\tau}_1^{(-p \sum q_i)}. \quad (6)$$

In $\varphi(\mathcal{L}_n)$, relation (6) is equivalent to R1($-p \sum q_i$) if $k' = 0$, and is equivalent to R3($k', -p \sum q_i$) if $k' \neq 0$. Hence if the k_i are not all equal, then relation (1) implies R2(p) and R1($-p \sum q_i$), or R2(p) and R3($k', -p \sum q_i$). And conversely, the set of the relations R2(p) and R1($-p \sum q_i$) implies relation (1), as does the set of the relations R2(p) and R3($k', -p \sum q_i$).

Finally, any relation in $\varphi(\mathcal{L}_n)$ is equivalent to a set of relations of type R1, R2 and R3. This terminates the proof of step 1..

2. Let us now show that there exist four integers M, m, d, s such that $\varphi(\mathcal{L}_n)$ is isomorphic to the quotient of \mathcal{L}_n by the three relations R1(M), R2(m) and R3(d, s).

Let us define M, m, d, s as follows:

$$\begin{aligned} E_1 &= \{ k \in \mathbb{N}^* \mid \bar{\tau}_1^k = 1 \} \text{ and } M = \begin{cases} \min(E_1) \text{ if } E_1 \neq \emptyset \\ 0 \text{ if } E_1 = \emptyset, \end{cases} \\ E_2 &= \{ k \in \mathbb{N}^* \mid \bar{\tau}_1^k = \bar{\tau}_3^k \} \text{ and } m = \begin{cases} \min(E_2) \text{ if } E_2 \neq \emptyset \\ 0 \text{ if } E_2 = \emptyset, \end{cases} \\ E_3 &= \{ k \in \mathbb{N}^* \mid (\bar{\tau}_1 \bar{\tau}_3 \dots \bar{\tau}_{n-1})^k \in \langle \bar{\tau}_1 \rangle \} \text{ and } d = \begin{cases} \min(E_3) \text{ if } E_3 \neq \emptyset \\ 0 \text{ if } E_3 = \emptyset, \end{cases} \\ s &\text{ is chosen arbitrarily in } \{ k \in \mathbb{N}^* \mid (\bar{\tau}_1 \bar{\tau}_3 \dots \bar{\tau}_{n-1})^d = \bar{\tau}_1^k \}. \end{aligned}$$

Then by definition of M, m, d and s , the three relations R1(M), R2(m) and R3(d, s) hold in $\varphi(\mathcal{L}_n)$. According to step 1., any relation like (1) comes from some relations of type R1(M), $M \in \mathbb{Z}$, R2(m), $m \in \mathbb{Z}$ and R3(d, s), $d, s \in \mathbb{Z}$, that take place in $\varphi(\mathcal{L}_n)$. Let us then show that

any relation R of type R1, R2 or R3 that holds in $\varphi(\mathcal{L}_n)$ comes from the three relations R1(M), R2(m) and R3(d, s).

- If R is of type R1: Let M' be a nonzero integer such that the relation R1(M') is satisfied in $\varphi(\mathcal{L}_n)$. Then E_1 is nonempty, hence M is nonzero. Notice that the union of both relations R1(M) and R1(M') is equivalent to the relation R1($M \wedge M'$), where $a \wedge b$ is the greatest common divisor of a and b . However, by definition of M , we have $M \leq M \wedge M'$, so $M = M \wedge M'$, hence M divides M' . Consequently, R1(M) implies R1(M').
- If R is of type R2: Similarly, any relation of type R2(m') where m' is a nonzero integer is induced by R2(m).
- If R is of type R3: If there exist two nonzero integers d' and s' with $d' \neq 0$ such that R3(d', s') takes place in $\varphi(\mathcal{L}_n)$, then E_3 is nonempty. So d is nonzero and the conjunction of R3(d', s') and R3(d, s) induces R3($kd' + \ell d, ks' + \ell s$), for all integers k and ℓ . Let us choose k and ℓ such that $kd' + \ell d = d' \wedge d$. By definition of d , we have $d \leq (d' \wedge d)$, so $d = (d' \wedge d)$ and d divides d' . Let p be the integer d'/d . We have:

$$\left\{ \begin{array}{l} \text{R3}(d, s) \\ \text{R3}(d', s') \end{array} \right\} \iff \left\{ \begin{array}{l} \text{R3}(d, s) \\ \text{R3}(pd, ps) \\ \text{R3}(pd, s') \end{array} \right\} \iff \left\{ \begin{array}{l} \text{R3}(d, s) \\ \text{R3}(pd, ps) \\ \text{R1}(|ps - s'|) \end{array} \right\}$$

Again, the definition of M implies that $|ps - s'|$ is a multiple of M . Hence R3(d', s') comes from the three relations R1(M), R2(m) and R3(d, s).

3. Let M , m , d and s be the integers defined in step 2.. According to step 2., $\varphi(\mathcal{L}_n)$ is isomorphic to the group \mathcal{L}_n quotiented by the three relations R1(M), R2(m), and R3(d, s). Let us show that if M is nonzero, then m and d are also nonzero. Then let us determine the divisibility relations that link these four integers.

- If M is nonzero, then R1(M) implies R2(M) and R3($M, 0$), so by definition of m and d , we have that m and d are nonzero.
- Since R1(M) implies R2(M), the relations R2(M) and R2(m) coexist in $\varphi(\mathcal{L}_n)$, so R2($M \wedge m$) is satisfied, too. Then, by definition of m , m is smaller than or equal to $M \wedge m$, so we have $m = M \wedge m$. Hence m divides M .
- Similarly, the relation R2(m) implies R3(m, rm). Now, R3(m, rm) and R3(d, s) imply a third relation R3(u, v) where $u = m \wedge d$, and v is an integer determined by r, m, d and s . But by definition of d , d is smaller than or equal to u . Hence d divides m .
- As for the integer s in R3(d, s), we have seen in step 1. that R3(d, s) implies R2(s), so m divides s .
- We still have to show that M divides $(r - \frac{s}{d})m$. Let us start from the relation R3(d, s) in which we replace $\bar{\tau}_1^s$ by $\bar{\tau}_1^{kd}$ where $k = \frac{s}{d}$. We get:

$$[(\bar{\tau}_1 \bar{\tau}_3 \bar{\tau}_5 \dots \bar{\tau}_{n-1}) \bar{\tau}_1^{-k}]^d = 1, \quad (7)$$

then:

$$[(\bar{\tau}_3 \bar{\tau}_1^{-1})(\bar{\tau}_5 \bar{\tau}_1^{-1}) \dots (\bar{\tau}_{n-1} \bar{\tau}_1^{-1}) \bar{\tau}_1^{(r-k)}]^d = 1. \quad (8)$$

Since m is a multiple of d , we get:

$$[(\bar{\tau}_3\bar{\tau}_1^{-1})(\bar{\tau}_5\bar{\tau}_1^{-1})\dots(\bar{\tau}_{n-1}\bar{\tau}_1^{-1})\bar{\tau}_1^{(r-k)}]^m = 1. \quad (9)$$

Now, according to R2(m), for all $i \in \text{Odd}(n) \setminus \{1\}$, we have $(\bar{\tau}_i\bar{\tau}_1^{-1})^m = 1$. Hence (9) implies:

$$\bar{\tau}_1^{(r-k)m} = 1.$$

In other words, R1($(r-k)m$) takes place in $\varphi(\mathcal{L}_n)$. Then, as before, we deduce from definition of M that M divides $(r-k)m$.

4. Let us show that φ is cyclic if and only if $d = 1$.

If φ is cyclic, then R2(1) holds, and so does R3(1, r). Conversely, if $d = 1$, let us show that $m = 1$. Let ξ be the element τ_1^s . If $d = 1$, we have:

$$\bar{\tau}_1\bar{\tau}_3\bar{\tau}_5\dots\bar{\tau}_{n-1} = \bar{\xi}, \quad (10)$$

whence:

$$\bar{\tau}_1^{-1}\bar{\tau}_3^{-1} = \bar{\tau}_5\dots\bar{\tau}_{n-1}\bar{\xi}^{-1}. \quad (11)$$

Since $\bar{\xi} = \bar{\tau}_1^s$ and m divides s , then $\bar{\xi}$ is a multiple of $\bar{\tau}_1^m$. But according to the relation R2(m) and Lemma 5.2, we have $\bar{\tau}_1^m = \bar{\tau}_2^m = \dots = \bar{\tau}_{n-1}^m$, so $\bar{\tau}_1^m$ is central in $\varphi(\mathcal{B}_n)$, so $\bar{\xi}$ is central in $\varphi(\mathcal{B}_n)$. According to equality (11), it follows that $\bar{\tau}_2$ commutes with the right-hand side, hence $\bar{\tau}_2$ commutes with the left-hand side. So we get:

$$\bar{\tau}_2\bar{\tau}_1^{-1}\bar{\tau}_3^{-1} = \bar{\tau}_1^{-1}\bar{\tau}_3^{-1}\bar{\tau}_2,$$

whence

$$\bar{\tau}_1\bar{\tau}_2\bar{\tau}_1^{-1} = \bar{\tau}_3^{-1}\bar{\tau}_2\bar{\tau}_3,$$

but

$$\bar{\tau}_3^{-1}\bar{\tau}_2\bar{\tau}_3 = \bar{\tau}_2\bar{\tau}_3\bar{\tau}_2^{-1},$$

so

$$\bar{\tau}_1\bar{\tau}_2\bar{\tau}_1^{-1} = \bar{\tau}_2\bar{\tau}_3\bar{\tau}_2^{-1},$$

and by conjugating by $\bar{\tau}_1\bar{\tau}_2\bar{\tau}_3\bar{\tau}_4$:

$$\bar{\tau}_2\bar{\tau}_3\bar{\tau}_2^{-1} = \bar{\tau}_3\bar{\tau}_4\bar{\tau}_3^{-1},$$

whence

$$\bar{\tau}_1\bar{\tau}_2\bar{\tau}_1^{-1} = \bar{\tau}_3\bar{\tau}_4\bar{\tau}_3^{-1},$$

then

$$\bar{\tau}_2 = (\bar{\tau}_1\bar{\tau}_2\bar{\tau}_1^{-1})\bar{\tau}_1(\bar{\tau}_1\bar{\tau}_2\bar{\tau}_1^{-1})^{-1} = (\bar{\tau}_3\bar{\tau}_4\bar{\tau}_3^{-1})\bar{\tau}_1(\bar{\tau}_3\bar{\tau}_4\bar{\tau}_3^{-1})^{-1} = \bar{\tau}_1,$$

so $\bar{\tau}_2 = \bar{\tau}_1$. Hence φ is cyclic. \square

Definition 5.4 ($\mathcal{L}_n(M, m, d, s)$).

For all quadruples of integers (M, m, d, s) , as soon as this definition makes sense (i.e. when m is a multiple of d and M is a multiple of m , according to Lemma 5.3), let us denote by $\mathcal{L}_n(M, m, d, s)$ the group $\langle \tau_i, i \in \text{Odd}(n) \rangle$ quotiented by the relations (R1(M)), (R2(m)), (R3(d, s)). For example, $\mathcal{L}_n(0, 0, 0, 0) \cong \mathbb{Z}^r$ and $\mathcal{L}_n(M, M, M, rM) \cong (\mathbb{Z}/M\mathbb{Z})^r$.

Lemma 5.5 (Cardinality of $\mathcal{L}_n(M, m, d, s)$).

For all $M > 0$, $m \geq 2$, d and s , the cardinality of $\mathcal{L}_n(M, m, d, s)$ is equal to qdm^{r-1} where $q = \frac{M}{m}$ and $r = \frac{n}{2}$.

Proof. The group $\mathcal{L}_n(0, 0, 0, 0)$ is spanned by:

$$\tau_1, \tau_3, \tau_5, \dots, \tau_{n-3}, \tau_{n-1}. \quad (1)$$

Let us set $u_i = \tau_i \tau_1^{-1}$ for all $i \in \text{Odd}(n) \setminus \{1\}$. We set $k = \frac{s}{d}$ (k is an integer for, according to Lemma 5.3, d divides m which divides s). Then we set $w = (u_3 u_5 \dots u_{n-3} u_{n-1}) \tau_1^{(r-k)}$. Thanks to a change of variables, we go from the set (1) spanning $\mathcal{L}_n(0, 0, 0, 0)$ to the below set (2) still spanning $\mathcal{L}_n(0, 0, 0, 0)$:

$$\tau_1, u_3, u_5, \dots, u_{n-3}, w. \quad (2)$$

With this change of variables, the relation $\text{R1}(M)$ is now equivalent to:

$$\tau_1^M = 1, u_3^M = 1, u_5^M = 1, \dots, u_{n-3}^M = 1, w^M = 1. \quad (3)$$

Let us denote by $\xi \mapsto \bar{\xi}$ the canonical homomorphism from $\mathcal{L}_n(0, 0, 0, 0)$ to $\mathcal{L}_n(M, M, M, rM)$, which is the quotient of $\mathcal{L}_n(0, 0, 0, 0)$ by $\text{R1}(M)$. According to Lemma 5.3, M divides $(r-k)m$, so in $\mathcal{L}_n(M, M, M, rM)$, we have:

$$\bar{w}^m = (\bar{u}_3 \bar{u}_5 \dots \bar{u}_{n-3} \bar{u}_{n-1})^m \bar{\tau}_1^{(r-k)m} = (\bar{u}_3 \bar{u}_5 \dots \bar{u}_{n-3} \bar{u}_{n-1})^m.$$

Hence the relation $\text{R2}(m)$ in $\mathcal{L}_n(M, M, M, rM)$ is equivalent to:

$$\bar{u}_3^m = 1, \bar{u}_5^m = 1, \dots, \bar{u}_{n-3}^m = 1, \bar{w}^m = 1. \quad (4)$$

Finally, in $\mathcal{L}_n(M, M, M, rM)$, the relation $\text{R3}(d, s)$ is: $(\bar{\tau}_1 \bar{\tau}_3 \dots \bar{\tau}_{n-1})^d = \bar{\tau}_1^s$. Let us replace τ_1^s by τ_1^{kd} , the relation $\text{R3}(d, s)$ is equivalent to $[(\tau_1 \bar{\tau}_3 \bar{\tau}_5 \dots \bar{\tau}_{n-1}) \tau_1^{-k}]^d = 1$, and then to

$$[(\bar{\tau}_3 \bar{\tau}_1^{-1})(\bar{\tau}_5 \bar{\tau}_1^{-1}) \dots (\bar{\tau}_{n-1} \bar{\tau}_1^{-1}) \tau_1^{(r-k)}]^d = 1,$$

so the relation $\text{R3}(d, s)$ in $\mathcal{L}_n(M, M, M, rM)$ is equivalent to:

$$\bar{w}^d = 1. \quad (5)$$

Finally, since m divides M and since d divides m , the set of relations $\text{R1}(M)$, $\text{R3}(m)$ and $\text{R3}(d, s)$ is equivalent in $\mathcal{L}_n(0, 0, 0, 0)$ to:

$$\tau_1^M = 1, u_3^m = 1, u_5^m = 1, \dots, u_{n-3}^m = 1, w^d = 1. \quad (6)$$

Therefore a presentation by generators and relations of the group $\mathcal{L}_n(M, m, d, s)$ can be obtained from the lines (2) and (6). Therefore $\mathcal{L}_n(M, m, d, s)$ is isomorphic to $\mathbb{Z}/M\mathbb{Z} \times (\mathbb{Z}/m\mathbb{Z})^{r-2} \times \mathbb{Z}/d\mathbb{Z}$. So its cardinality is $Mm^{r-2}d = qdm^{r-1}$ where $q = \frac{M}{m}$. \square

5.2 Periodic geometric representations of \mathcal{B}_n

In the first proposition, we deal with the case where the boundary of Σ is nontrivial ($\Sigma = \Sigma_{g,b}$ with $b > 0$). The remainder of this subsection is devoted to the case without boundary ($b = 0$), which is harder. For all homomorphisms ρ from \mathcal{B}_n to $\mathcal{PMod}(\Sigma)$ and for all $i \leq n-1$, we denote by A_i the mapping class $\rho(\tau_i)$.

Proposition 5.6 (The periodic homomorphisms from \mathcal{B}_n to $\mathcal{PMod}(\Sigma_{g,b})$, $b > 0$, are cyclic).
Any periodic homomorphism ρ from \mathcal{B}_n to $\mathcal{PMod}(\Sigma_{g,b})$ where $g \leq \frac{n}{2}$ and $b > 0$ is cyclic.

Proof. Let ρ be a periodic homomorphism from \mathcal{B}_n to $\mathcal{PMod}(\Sigma)$. Notice that the mapping classes A_i for all $i \leq n-1$ are conjugate. So they are periodic and have the same order. Let us call m this order.

Since the boundary of Σ is nonempty, according to Lemma A.16, A_1 and A_4 span a cyclic group that we denote by Γ . Any generator of Γ is a product of powers of A_1 and A_4 , so Γ is a cyclic

group of order m . Now, the subgroups of Γ spanned on one hand by A_1 and on the other hand by A_4 have the same order m , so each of A_1 and A_4 spans independently Γ . Thus, in \mathcal{G} , any two standard generators that commute span the same cyclic group. Hence A_2 span the same cyclic group as A_4 , that is, the same cyclic group as A_1 . In particular A_2 and A_1 commute. But A_2 and A_1 satisfy a braid relation, so they have to be equal. Then, according to Lemma 3.1, ρ is cyclic. \square

Proposition 5.7 (The periodic homomorphisms from \mathcal{B}_n to $\text{Mod}(\Sigma_{g,0})$ are cyclic).

Let n be an integer greater than or equal to 6 and Σ the surface $\Sigma_{g,0}$ such that $g \leq \frac{n}{2}$. Any periodic homomorphism ρ from \mathcal{B}_n to $\text{Mod}(\Sigma)$ is cyclic.

Proof. We argue by contradiction. Let ρ be a periodic homomorphism. We assume that ρ is not cyclic. We separate the cases according to the orders of A_1 and $A_3A_1^{-1}$ (the order of $A_3A_1^{-1}$ is different from 1 since ρ is not cyclic).

1. When A_1 is of order 2.

If for all $i \leq n-1$, the mapping class A_i is of order 2, then $\rho(\mathcal{B}_n)$ is isomorphic to a quotient of the symmetric group \mathfrak{S}_n . It follows easily from the simplicity of \mathfrak{A}_n (remember that $n \geq 6$) that the only quotients of \mathfrak{S}_n are $\{1\}$, $\mathbb{Z}/2\mathbb{Z}$ and \mathfrak{S}_n . So the only nontrivial quotient of \mathfrak{S}_n is $\mathbb{Z}/2\mathbb{Z}$. However we assume that ρ is not cyclic, so $\rho(\mathcal{B}_n)$ has to be isomorphic to the group \mathfrak{S}_n . In particular, $\rho(\mathcal{B}_n)$ is finite, and its cardinality is:

$$n! = (n-1)! \times n \geq 5! \times n = 120n \geq 240g.$$

Now, according to the “84($g-1$)” theorem (see Corollary A.10), the cardinality of a finite subgroup of $\text{Mod}(\Sigma)$ is bounded by $42|\chi(\Sigma)| = 84g - 84$, whence a contradiction.

2. When A_1 is not of order 2, but $A_3A_1^{-1}$ is of order 2.

If $(A_3A_1^{-1})^2 = 1$, then $A_3^2 = A_1^2$, so according to Lemma 5.2, we have $A_1^2 = A_2^2 = \dots = A_{n-1}^2$. Let \mathcal{Z} be the centralizer $\mathcal{Z}_{\text{Mod}(\Sigma)}(A_1^2)$ of A_1^2 in $\text{Mod}(\Sigma)$ and let p be the canonical homomorphism from \mathcal{Z} to $\mathcal{Z}/\langle A_1^2 \rangle$. Notice that $\rho(\mathcal{B}_n)$ is included in \mathcal{Z} , so we can consider the homomorphism $p \circ \rho$ from \mathcal{B}_n to $\mathcal{Z}/\langle A_1^2 \rangle$. It is not cyclic, for $A_3A_1^{-1}$ is not a power of A_1^2 : indeed, if it existed an integer k such that $A_3 = A_1^{(1+2k)}$, by conjugation, we would have $A_5 = A_1^{(1+2k)}$, and so $A_3 = A_5$. But this is absurd for ρ is not cyclic. Thus, the homomorphism $p \circ \rho$ is not cyclic, but $p \circ \rho(\tau_1^2) = p(A_1^2) = 1$. Then, as we have seen it in step 1., $p \circ \rho(\mathcal{B}_n)$ is isomorphic to the group \mathfrak{S}_n and hence contains at least 240g elements. But $\rho(\mathcal{B}_n)$ is a (central) extension of $p \circ \rho(\mathcal{B}_n)$ by the finite group $\langle A_1^2 \rangle$, in other words, the following sequence is exact:

$$1 \rightarrow \langle A_1^2 \rangle \rightarrow \rho(\mathcal{B}_n) \xrightarrow{p} p \circ \rho(\mathcal{B}_n) \rightarrow 1.$$

Hence $\rho(\mathcal{B}_n)$ is a finite group that contains at least 480g elements. As in step 1., this is absurd.

3. Where A_1 is of order $M \geq 3$ and $A_3A_1^{-1}$ is of order m with $3 \leq m \leq M$.

According to Kerckhoff’s Theorem (cf. A.6), the abelian group $\langle A_i, i \in \text{Odd}(n) \rangle$ being finite, there exist a hyperbolic metric g on Σ and an injective homomorphism from $\langle A_i, i \in \text{Odd}(n) \rangle$ to $\text{Isom}(\Sigma; g)$. Let us denote by \mathcal{F} its image and \bar{A}_i the image of A_i for all $i \in \text{Odd}(n)$. Let us recall that we assume that ρ is not cyclic, so $\bar{A}_1 \neq \bar{A}_3$. We will show that the action of \mathcal{F} on the points of Σ is free, for if an element of \mathcal{F} had a fixed point in Σ , it would automatically have many, actually too much compared with Corollary A.8. We will conclude by showing that if the elements of \mathcal{F} do not have any fixed point, the inequality linking $\chi(\Sigma)$ and $\chi(\Sigma/\langle \mathcal{F} \rangle)$ given by Lemma A.7 cannot be satisfied, whence the contradiction.

a) Let us show that the action of \mathcal{F} on Σ is free.

Let x be a point of Σ and let $\text{Stab}(x)$ be the subgroup of \mathcal{F} that fixes the point x . Let us assume that $\text{Stab}(x)$ is not reduced to $\{1\}$. Let us recall that two isometries that fixes a same point and that have the same differential in this point are equal (cf. Lemma A.13). But the differential of an isometry in a fixed point is a rotation. Therefore $\text{Stab}(x)$ is a cyclic group. Let G be an isometry spanning $\text{Stab}(x)$, let M' be its order, with $2 \leq M' \leq M$, for on one hand G is not the identity, on the other hand G belongs to the abelian group \mathcal{F} spanned by elements of order M . We are going to count the number ℓ of fixed points of G . On one hand, according to Corollary A.8, we have:

$$\ell \leq 2 + \frac{2g}{M' - 1}. \quad (1)$$

On the other hand, if G commutes with another isometry G' , then the images by G' of all fixed points of G are again fixed points of G . Since the group \mathcal{F} is abelian, the set of fixed points of G contains the orbit of x by the group \mathcal{F} , so:

$$|\text{Orb}(x)| \leq \ell, \quad (2)$$

where $\text{Orb}(x)$ is the orbit of x . By definition of \mathcal{F} and according to Lemma 5.3, there exist four integers M', m', d and s such that \mathcal{F} is isomorphic to $\mathcal{L}_n(M', m', d, s)$. Now, since M is the order of A_1 and m is the order of $A_3A_1^{-1}$, we have $M' = M$ and $m' = m$. Hence \mathcal{F} is isomorphic to $\mathcal{L}_n(M, m, d, s)$ and according to Lemma 5.5, the cardinality of \mathcal{F} is $qd(m)^{r-1}$ where $q = \frac{M}{m}$ and $r = \frac{n}{2}$. We can then compute the cardinality of the orbit of x :

$$|\text{Orb}(x)| = \frac{|\mathcal{F}|}{|\text{Stab}(x)|} = \frac{qd(m)^{r-1}}{M'}. \quad (3)$$

From (1), (2) and (3), we get:

$$\frac{qd(m)^{r-1}}{M'} = |\text{Orb}(x)| \leq \ell \leq 2 + \frac{2g}{M' - 1}. \quad (4)$$

By multiplying all by $\frac{M'}{q}$, we get:

$$d(m)^{r-1} \leq 2\frac{M'}{q} + 2g \frac{1}{q} \frac{M'}{M' - 1}. \quad (5)$$

Since $\frac{M'}{q} \leq \frac{M}{q} = m$, we can bound $\frac{M'}{q}$ by m . We bound g by r , $\frac{1}{q}$ by 1, and $\frac{M'}{M' - 1}$ by 2. Then (5) becomes:

$$d(m)^{r-1} \leq 2m + 4r, \text{ with } \begin{cases} r = \frac{n}{2} \geq 3, \\ d \geq 2 \text{ and } d \text{ divides } m, \text{ according to Lemma 5.3,} \\ m \geq 3 \text{ by hypothesis.} \end{cases} \quad (6)$$

When $m = 3$, we have $d = 3$, so (6) becomes:

$$3^r \leq 6 + 4r, \quad (7)$$

but this equation is never satisfied for $r \geq 3$ (for $r = 3$, we get $27 \leq 6 + 12$ which is absurd, and for $r > 3$, this is even more flagrant). When $m \geq 4$, let us consider equation (6), we bound $4r$ by mr in the right-hand side, we divide the left-hand side and the right-hand side by m , then in the left-hand side, we replace m by its lower bound: 4, and d by its lower bound: 2. We get:

$$2 \times 4^{(r-2)} \leq 2 + r, \quad (8)$$

that is not satisfied for $r = 3$ and certainly not for $r > 3$. Thus, it was absurd to assume that $\text{Stab}(x) \neq \{1\}$. Hence the action of \mathcal{F} on Σ is free.

b) Let us apply the Riemann-Hurwitz' formula (cf. Lemma A.7) to the finite group \mathcal{F} :

$$\chi(\Sigma) + \sum(|\mathcal{F}| - o(Q_i)) = |\mathcal{F}| \cdot \chi(\Sigma/\mathcal{F}). \quad (9)$$

The surface Σ satisfies $\chi(\Sigma) = 2 - 2g$. Besides, as the action of \mathcal{F} on Σ is free, there is no point of ramification Q_i in the surface Σ/\mathcal{F} hence $\sum(|\mathcal{F}| - o(Q_i)) = 0$. So the two terms of equality (9) are negative. Since the elements of \mathcal{F} preserve the orientation, Σ/\mathcal{F} is an orientable closed surface with $\chi(\Sigma/\mathcal{F}) \leq -2$. But the order of \mathcal{F} is $qd(m)^{r-1}$ with $q \geq 1$, $d \geq 2$, $m \geq 2$ and $r \geq g$, so $|\mathcal{F}| \geq 2^g$, so the equality (9) implies $2 - 2g \leq 2^g(-2)$, i.e.:

$$g \geq 1 + 2^g, \text{ with } g \geq 0, \quad (10)$$

which is absurd. \square

5.3 Pseudo-Anosov geometric representations of \mathcal{B}_n

Proposition 5.8 (The pseudo-Anosov homomorphisms from \mathcal{B}_n to $\mathcal{PMod}(\Sigma)$ are cyclic).

Let n be an integer greater than or equal to 6 and let Σ be a surface $\Sigma_{g,b}$ where $g \leq \frac{n}{2}$. Any pseudo-Anosov homomorphism from \mathcal{B}_n to $\mathcal{PMod}(\Sigma)$ is cyclic.

Proof. Let $\rho : \mathcal{B}_n \rightarrow \mathcal{PMod}(\Sigma)$ be a pseudo-Anosov homomorphism. For all $i \leq n-1$, we set again $A_i = \rho(\tau_i)$.

1. The mapping class A_1 is pseudo-Anosov, so according to Proposition ??.(iv), its centralizer is virtually infinite cyclic. Since the mapping class A_3 commutes with A_1 , there exist two nonzero integers p and p' such that $A_1^{p'} = A_3^p$. By conjugating this equality by $A_3A_4A_3$, we get $A_1^{p'} = A_4^p$. Hence $A_3^p = A_4^p$, so according to Lemma 5.2:

$$A_1^p = A_2^p = A_3^p \cdots = A_{n-1}^p. \quad (1)$$

Let us exploit this. We separate the cases whether $b > 0$ (cf. 2.) or $b = 0$ (cf. 3. - 5.).

2. When $b > 0$, we produce a direct proof. According to Proposition 3.8, there exists $\tilde{\rho}$, a lift of $\rho \in \text{Hom}(\mathcal{B}_n, \mathcal{PMod}(\Sigma))$ in $\text{Hom}(\mathcal{B}_n, \text{Mod}(\Sigma, \partial\Sigma))$. For all $i \leq n-1$, let us denote by \tilde{A}_i the mapping class $\tilde{\rho}(\tau_i)$, so that \tilde{A}_i is a lift of A_i . Let us set then $W = \tilde{A}_3\tilde{A}_1^{-1}$. Since $A_1^p = A_3^p$, the mapping class W^p is a multitwist along the boundary components. Let Z be the mapping class $(\tilde{A}_1\tilde{A}_2\tilde{A}_3)^2$. Then $Z\tilde{A}_1Z^{-1} = \tilde{A}_3$ and $Z\tilde{A}_3Z^{-1} = \tilde{A}_1$, so $ZW^pZ^{-1} = W^{-p}$. Since W is central in $\text{Mod}(\Sigma, \partial\Sigma)$, Z and W^p commute, so we have $W^{2p} = \text{Id}$. But $\text{Mod}(\Sigma, \partial\Sigma)$ is torsion-free according to Lemma A.14, so $W = \text{Id}$. Hence $\tilde{A}_1 = \tilde{A}_3$ and $\tilde{\rho}$ is cyclic, hence ρ is cyclic.

3. When $b = 0$, we argue by contradiction and we assume that ρ is not cyclic. Then, according to Lemma 5.2, the A_i , $1 \leq i \leq n-1$, are pairwise distinct. Let us consider the group $\widetilde{\text{Centr}}(A_1^p)$ (cf. Definition ?? of Subsection ??). According to (1), $\rho(\mathcal{B}_n) \subset \widetilde{\text{Centr}}(A_1^p)$. Let ℓ be the homomorphism associated to A_1^p defined by Proposition ??. According to this proposition, the cardinality of $\text{Ker}(\ell)$ satisfies:

$$|\text{Ker}(\ell)| \leq 6|\chi(\Sigma)|. \quad (2)$$

Since all the A_i , $i \leq n-1$, are conjugate in $\widetilde{\text{Centr}}(A_1^p)$, $\ell(A_i)$ is independent of the index i when i ranges from 1 to $n-1$. Hence the group spanned by $A_jA_k^{-1}$ where $j, k \leq n-1$ is included in $\text{Ker}(\ell)$. Yet, we are going to show that its cardinality is greater than $6|\chi(\Sigma)|$, whence the contradiction.

4. Let us assume that $(A_1A_3^{-1})$ is of order $p = 2$. Recall that ρ is not cyclic, so A_1 and A_3 are different. Then the subgroup \mathcal{F} of $\text{Ker}(\ell)$ defined by:

$$\mathcal{F} := \langle A_iA_{n-1}^{-1}; 1 \leq i \leq n-3 \rangle$$

is isomorphic to a quotient \mathfrak{S}_{n-2} by the homomorphism: $(12) \mapsto A_1 A_{n-1}^{-1}$, $(23) \mapsto A_2 A_{n-1}^{-1}$, \dots , $(n-3, n-2) \mapsto A_{n-3} A_{n-1}^{-1}$. However, $A_1 \neq A_3$, so this quotient is neither $\{1\}$ nor $\mathbb{Z}/2\mathbb{Z}$. Then, when $n \geq 8$, because of the simplicity of \mathfrak{A}_6 this quotient has to be \mathfrak{S}_{n-2} . When $n = 6$, the only quotient of \mathfrak{S}_4 different from $\{1\}$, $\mathbb{Z}/2\mathbb{Z}$ and \mathfrak{S}_4 is the quotient of \mathfrak{S}_4 by the normal closure of the element $(12)(34)$. The image of $(12)(34)$ in \mathcal{F} is $(A_1 A_5^{-1})(A_3 A_5^{-1})$, which is equal to $A_1 A_3 A_5^{-2}$, hence equal to $A_1 A_3^{-1}$, for $A_3^{-2} = A_5^{-2}$ according to (1). Since $A_1 \neq A_3$, $A_1 A_3^{-1}$ is not trivial. Hence \mathcal{F} is not isomorphic to the above quotient of \mathfrak{S}_4 . Then, even when $n = 6$, \mathcal{F} is isomorphic to \mathfrak{S}_{n-2} . Hence $\text{Ker}(\ell)$ contains \mathcal{F} that owns $(n-2)!$ elements. When $n \geq 8$, we get:

$$|\text{Ker}(\ell)| \geq |\mathcal{F}| = (n-2)! \geq 5!(n-2) > 6(n-2) \geq 6(2g-2) = 6|\chi(\Sigma)|. \quad (3)$$

But (2) and (3) lead to a contradiction, this is the expected contradiction.

The case $n = 6$ implies $|\mathcal{F}| = |\mathfrak{S}_4| = 4! = 24 \geq 6|\chi(\Sigma)|$, since $n = 6$ implies that $g \leq \frac{n}{2} = 3$, and then $|\chi(\Sigma)| \leq 4$. However $\text{Ker}(\ell)$ contains the element $A_{n-2} A_{n-1}^{-1}$, too, which is different from any element of \mathcal{F} , for \mathcal{F} is in the centralizer of A_{n-1} , whereas $A_{n-2} A_{n-1}^{-1}$ is not. Indeed, if $A_{n-2} A_{n-1}^{-1}$ was in the centralizer of A_{n-1} , then A_{n-2} and A_{n-1} would commute. However they satisfy a braid relation, so they would be equal and ρ would be cyclic: this is absurd. Thus $\text{Ker}(\ell)$ contains \mathcal{F} and the element $A_{n-2} A_{n-1}^{-1}$, which does not belong to \mathcal{F} . Since the cardinality of \mathcal{F} satisfies $|\mathcal{F}| \geq 6|\chi(\Sigma)|$, then the cardinality of $\text{Ker}(\ell)$ satisfies $|\text{Ker}(\ell)| > 6|\chi(\Sigma)|$, which contradicts (2). This is the expected contradiction.

5. Let us assume that $(A_1 A_3^{-1})$ is of order $p \geq 3$ and let us consider the abelian groups \mathcal{H} and \mathcal{H}' defined by:

$$\begin{aligned} \mathcal{H} &:= \langle A_i, i \in \text{Odd}(n) \rangle_{\mathcal{M}\text{od}(\Sigma)} \\ \text{and } \mathcal{H}' &:= \langle A_i A_{n-1}^{-1}, i \in \text{Odd}(n-2) \rangle_{\mathcal{M}\text{od}(\Sigma)}. \end{aligned}$$

Let us apply Lemma 5.3 to these two groups:

- *Concerning the group \mathcal{H} .* It is clear that there exist two integers d and s such that \mathcal{H} is isomorphic to $\mathcal{L}_n(0, p, d, s)$, where $d \neq 1$, d divides p , and p divides s , according to Lemma 5.3. Moreover, since $\ell(A_1) = \dots = \ell(A_{n-1}) > 0$, all these relations have to be homogeneous, so by considering the relation $\text{R3}(d, s)$, it follows $s = rd$. The relation $\text{R3}(d, s)$ then becomes:

$$\left(\prod_{i \in \text{Odd}(n)} A_i \right)^d = A_1^{rd}, \quad (4)$$

and it implies:

$$\left(\prod_{i \in \text{Odd}(n-3)} A_i A_{n-1}^{-1} \right)^d = (A_1 A_{n-1}^{-1})^{rd}, \quad (5)$$

- *Concerning the group \mathcal{H}' .* It is clear that \mathcal{H}' is isomorphic to $\mathcal{L}_{n-2}(p, p, d', s')$ where d' and s' are to be determine. The relation $(\text{R3}(d', s'))$ is equivalent to:

$$\left(\prod_{i \in \text{Odd}(n-3)} A_i A_{n-1}^{-1} \right)^{d'} = (A_1 A_{n-1}^{-1})^{s'}, \quad (6)$$

and implies:

$$\left(\prod_{i \in \text{Odd}(n)} A_i \right)^{d'} = A_1^{s'} A_{n-1}^{(rd' - s')}. \quad (7)$$

Since p divides s' , according to Lemma 5.3, we have $A_1^{s'} = A_{n-1}^{s'}$ and (7) becomes:

$$\left(\prod_{i \in \text{Odd}(n)} A_i \right)^{d'} = A_{n-1}^{rd'}. \quad (8)$$

In (8), by conjugation, we can replace $A_{n-1}^{rd'}$ by $A_1^{rd'}$. Let us compare the equalities (4) and (8). By definition of d , it follows from that comparison that d divides d' . Moreover, by comparing (5) and (6), it follows by definition of d' that d' divides d . Thus $d' = d$, so \mathcal{H}' is isomorphic to $\mathcal{L}_{n-2}(p, p, d, s')$, and according to Lemma 5.3, the following holds:

$$d \geq 2, d \text{ divides } p. \quad (9)$$

Then according to Lemma 5.5, $|\mathcal{H}'| = dp^{r-2}$. The only pairs (p, d) that respect (9) and such that $p < 6$ are (3,3), (4,2), (4,4) and (5,5). However, if $(p, d) = (4, 2)$, then r is even. Indeed, as we saw it in the lines preceding (4), p divides s and s is equal to rd . We check in the following table all the possible values of dp^{r-2} for the pairs (p, d) where $p < 6$, as a function of r , and we give a lower bound to the values dp^{r-2} for the pairs (p, d) with $p \geq 6$, as a function of r .

$r \setminus (p, d)$	(3, 3)	(4, 2)	(4, 4)	(5, 5)	(p, d) with $p \geq 6$
$r = 3$	9	–	16	25	$dp^{r-2} \geq 2 \times 6 = 12$
$r = 4$	27	32	64	125	$dp^{r-2} \geq 2 \times 6^2 = 72$
$r \geq 5$	$27 \times 3^{r-4}$	$32 \times 4^{r-4}$	$64 \times 4^{r-4}$	$125 \times 5^{r-4}$	$dp^{r-2} \geq 2p^{r-2} = 72 \times 6^{r-4}$

Table 1 – Computation of dp^{r-2} as a function of d , p and r .

According to Table 1, for all $r \geq 3$, the expression dp^{r-2} achieves its lower bound when $p = d = 3$, hence:

$$|\mathcal{H}'| \geq 3^{r-1}. \quad (11)$$

However, $\text{Ker}(\ell)$ contains also the element $A_2A_{n-1}^{-1}$, which is of order p , too. And $A_2A_{n-1}^{-1}$ does not commute with A_1 (otherwise, A_2 would commute with A_1 , we would have $A_1 = A_2$ and ρ would be cyclic). Since \mathcal{H}' is in the centralizer of A_1 , the mapping class $A_2A_{n-1}^{-1}$ cannot belong to \mathcal{H}' . Similarly $(A_2A_{n-1}^{-1})^{-1}$ cannot belong to \mathcal{H}' . But $A_2A_{n-1}^{-1}$ and its inverse are distinct, for $p \geq 3$. Then the group $\langle \mathcal{H}' \cup A_2A_{n-1}^{-1} \rangle$ contains the following set:

$$\{ H(A_2A_{n-1}^{-1})^k, H \in \mathcal{H}', k \in \{-1, 0, 1\} \}.$$

Its cardinality is $3|\mathcal{H}'|$. Hence $|\text{Ker}(\ell)| \geq 3^r$. But for all integers of $r \geq 3$, the number 3^r is greater than $6(2r - 2)$, which is greater than or equal to $6|\chi(\Sigma)|$. Thus:

$$|\text{Ker}(\ell)| > 6|\chi(\Sigma)|. \quad (12)$$

This contradicts assertion (2). This is the expected contradiction and the end of the proof. \square

6 Adding an n^{th} generator to the standard presentation of \mathcal{B}_n

Completing the standard presentation of the braid group

We introduce the following element of the braid group \mathcal{B}_n :

$$\delta = \tau_1\tau_2 \dots \tau_{n-1}.$$

We then define an n^{th} generator τ_0 by setting:

$$\tau_0 = \delta\tau_{n-1}\delta^{-1}.$$

We adopt the following convention: for all integers $k \in \mathbb{Z}$, τ_k is the standard generator τ_ℓ where ℓ is the remainder of the euclidian division of k by n . Then, for all $i \in \{0, \dots, n-1\}$, we have:

$$\delta \tau_i \delta^{-1} = \tau_{i+1}.$$

Moreover, for all pairs of integers (i, j) , we denote by $|i-j|_n$ the integer $\min(\{|i-j+kn|, k \in \mathbb{Z}\})$. Then, the braid group with n strands \mathcal{B}_n admits the following presentation:

- generators: $\tau_i, i \in \{0, 1, \dots, n-1\}$,
- relations: for all $i, j \in \{0, 1, \dots, n-1\}$:

$$\begin{cases} \tau_{i+1}\tau_{i+2} \dots \tau_{i+n-1} = \tau_{j+1}\tau_{j+2} \dots \tau_{j+n-1} \\ \tau_i\tau_j = \tau_j\tau_i \text{ when } |i-j|_n \neq 1 \\ \tau_i\tau_j\tau_i = \tau_j\tau_i\tau_j \text{ when } |i-j|_n = 1. \end{cases}$$

From now on, the *standard generators* of \mathcal{B}_n will refer to $\tau_i, i \in \{0, \dots, n-1\}$. Such modifications of the classical presentation of the braid group \mathcal{B}_n have been generalized by V. Sergiescu (cf. [S]). We do not need τ_0 to define a braid homomorphism, since τ_0 can be obtained from the other generators, but we need τ_0 to consider the action of $\langle \delta \rangle$ by conjugation on the set of the n standard generators. Depending on our need, τ_0 will appear explicitly in the statements or not.

Let $D = \rho(\delta) = A_1 A_2 \dots A_{n-1}$. We set of course $A_0 = \rho(\tau_0) = D A_{n-1} D^{-1}$ and more generally, we set $A_k = \rho(\tau_k)$. Let $\mathcal{G}_0 = \{A_0, A_1, \dots, A_{n-1}\} = \mathcal{G} \cup \{A_0\}$. We introduce A_0 only now but all the statements that were true for \mathcal{G} are also true for \mathcal{G}_0 .

7 The special curves $\sigma_s(\mathcal{G}_0)$

Hypotheses.

Let $n \geq 6$ an even number, let $\Sigma = \Sigma_{g,b}$ with $g \leq \frac{n}{2}$, and let $\rho : \mathcal{B}_n \rightarrow \mathcal{PMod}(\Sigma)$ such that:

- ρ is non-cyclic by assumption,
- $\sigma_p(\mathcal{G}_0) = \emptyset$ by assumption, inspired by Proposition 4.7,
- $\sigma(\mathcal{G}_0) \neq \emptyset$ as a consequence of the non-cyclicity of ρ , after Theorem 5.1.

For all i , we have set $A_i = \rho(\tau_i)$. We will study A_1, A_2, \dots, A_{n-1} via their canonical reduction systems $\sigma(A_1), \sigma(A_2), \dots, \sigma(A_{n-1})$. Recall that we aim to prove that ρ is a transvection of monodromy homomorphism, that is, there exists a triple $((a_i)_{i \leq n-1}, \varepsilon, V)$ such that for all integers $i \in \{1, 2, \dots, n-1\}$, we have:

$$\begin{aligned} A_i &= T_{a_i}^\varepsilon V, \\ \sigma(A_i) &= \{a_i\} \cup \sigma(V). \end{aligned}$$

The curves a_i and the curves in $\sigma(V)$ play two very different roles in the description of ρ . For instance, $I(a_i, a_{i+1}) \neq 0$ whereas $I(\sigma(V), \sigma(\mathcal{G}_0)) = 0$. In order to stress this matter of fact, we set the following definition.

Normal curves, special curves

We say that a curve a belonging to $\sigma(\mathcal{G}_0)$ is *special* if it satisfies $I(a, \sigma(\mathcal{G}_0)) \neq 0$, and that it is *normal* if it satisfies $I(a, \sigma(\mathcal{G}_0)) = 0$. We denote by $\sigma_s(\mathcal{G}_0)$ the set of special curves, and by $\sigma_n(\mathcal{G}_0)$ the set of normal curves. Moreover, for all $A \in \mathcal{G}_0$, we set

$$\begin{aligned} \sigma_n(A) &= \sigma_n(\mathcal{G}_0) \cap \sigma(A), \\ \sigma_s(A) &= \sigma_s(\mathcal{G}_0) \cap \sigma(A). \end{aligned}$$

Thus, when ρ is a transvection of monodromy homomorphism as above, the curves a_i are special whereas the curves of $\sigma(V)$ are normal.

The aim of this section is to prove Proposition 7.1 which constitutes both the hardest and the most important step in the proof of Theorem 1. We mention in Proposition 7.1 an action of \mathcal{B}_n on $\text{Curv}(\Sigma)$ which will be introduced in Subsection 7.1.

Proposition 7.1 (Properties of the normal curves and the special curves). *Let a be a curve of $\sigma(\mathcal{G}_0)$. Then:*

(i) *The following statements are equivalent:*

- a is special,
- there exists a unique $i \in \{0, 1, \dots, n-1\}$ such that $a \in \sigma(A_i)$,
- $I(a, \delta.a) = I(a, \delta^{-1}.a) \neq 0$,
- $|\langle \delta \rangle.a| = n$.

(ii) *The following statements are equivalent:*

- a is normal,
- for all $i \in \{0, \dots, n-1\}$, we have $a \in \sigma(A_i)$,
- $I(a, \sigma(\mathcal{G}_0)) = 0$,
- $|\langle \delta \rangle.a| < n$.

(iii) *The curves of $\sigma(\mathcal{G}_0)$ split as follows:*

- $\sigma(\mathcal{G}_0)$ admits the partition: $\sigma(\mathcal{G}_0) = \sigma_s(\mathcal{G}_0) \sqcup \sigma_n(\mathcal{G}_0)$,
- $\sigma_s(\mathcal{G}_0)$ is nonempty and contains n or $2n$ curves, depending on whether $|\sigma_s(A_1)| = 1$ or $|\sigma_s(A_1)| = 2$.

(iv) *The curves of $\sigma(\mathcal{G}_0)$ satisfy the following properties of stability:*

- $\sigma_n(\mathcal{G}_0)$ is stable under the action of \mathcal{B}_n on $\text{Curv}(\Sigma)$ and the restriction of this action on $\sigma_n(\mathcal{G}_0)$ is cyclic: for all $a \in \sigma_n(\mathcal{G}_0)$ and all integers $i, j \in \{0, \dots, n-1\}$, we have $A_i(a) = A_j(a)$.
- $\sigma_s(\mathcal{G}_0)$ is stable under the action of \mathcal{J} on $\text{Curv}(\Sigma)$.

7.1 Action of \mathcal{B}_n on the simplexes of curves

Cyclic actions.

- An action of a group G on a set \mathcal{E} will be said *cyclic* if its structural homomorphism $\varphi : G \rightarrow \mathfrak{S}(\mathcal{E})$ is such that the quotient $G/\text{Ker}(\varphi)$ is a cyclic group.
- A *cyclic action on a set \mathcal{E}* will be an action of a cyclic group on \mathcal{E} .

- A *cyclic action on a graph* Γ will be the data of a homomorphism from a cyclic group in $\text{Aut}(\Gamma)$. Recall that an element in $\text{Aut}(\Gamma)$, the *automorphisms group of* Γ , is a pair of bijections, one on the set of the vertices, the other on the set of the edges, such that the images of the extremities of an edge are the extremities of the image of this edge.

The subgroups \mathcal{F}_n and \mathcal{F}_n^* of \mathcal{B}_n

- There exists a unique homomorphism $\lambda : \mathcal{B}_n \rightarrow \mathbb{Z}$ such that $\lambda(\tau_1) = 1$. It is called sometimes *the degree* or *the exponent*. Let $[\mathcal{B}_n, \mathcal{B}_n]$ be the commutators group of \mathcal{B}_n . Let $\langle\langle \cdot \rangle\rangle_{\mathcal{B}_n}$ denote the normal closure in \mathcal{B}_n . Then we have $\text{Ker}(\lambda) = [\mathcal{B}_n, \mathcal{B}_n] = \langle\langle \tau_3\tau_1^{-1} \rangle\rangle_{\mathcal{B}_n}$. We denote by \mathcal{F}_n this group. We also define

$$\mathcal{F}_n^* = \langle \tau_i\tau_1^{-1}, 3 \leq i \leq n-1 \rangle_{\mathcal{B}_n} \subsetneq \text{Ker}(\lambda).$$

- Let us make some remarks about these two subgroups.
 1. Let φ be a homomorphism from \mathcal{B}_n in a group G . The homomorphism φ is cyclic if and only if $\varphi(\tau_1) = \varphi(\tau_2) = \dots = \varphi(\tau_{n-1})$, if and only if the induced homomorphism by φ on \mathcal{F}_n is trivial. More conceptually, we could have said that φ is cyclic if and only if $\varphi(\mathcal{B}_n)$ is cyclic, if and only if $\mathcal{B}_n/\text{Ker}(\varphi)$ is cyclic, if and only if $[\mathcal{B}_n, \mathcal{B}_n] \subset \text{Ker}(\varphi)$ (since $\mathcal{B}_n/[\mathcal{B}_n, \mathcal{B}_n]$ is cyclic), if and only if the induced homomorphism by φ on $\mathcal{F}_n = [\mathcal{B}_n, \mathcal{B}_n]$ is trivial.
 2. A homomorphism from \mathcal{F}_n in a group G is trivial if and only if the induced homomorphism by φ on \mathcal{F}_n^* is trivial, since $\langle\langle \mathcal{F}_n^* \rangle\rangle_{\mathcal{B}_n} = \mathcal{F}_n$.
 3. The group \mathcal{F}_n^* is clearly isomorphic to \mathcal{B}_{n-2} . A homomorphism φ from \mathcal{F}_n^* will of course be said *cyclic* if $\varphi(\mathcal{F}_n^*)$ is cyclic, which is equivalent to saying that $\varphi(\tau_3\tau_1^{-1}) = \varphi(\tau_4\tau_1^{-1}) = \dots = \varphi(\tau_{n-1}\tau_1^{-1})$.
 4. All homomorphisms from \mathcal{B}_n that induce by restriction to \mathcal{F}_n^* a cyclic homomorphism are cyclic themselves. Indeed if φ is such a homomorphism, then the equality $\varphi(\tau_3\tau_1^{-1}) = \varphi(\tau_4\tau_1^{-1})$ holds. Consequently, we have $\varphi(\tau_3) = \varphi(\tau_4)$ and hence φ is cyclic.

We sum up these remarks in the following Lemma.

Lemma 7.2 (Cyclic homomorphisms/actions and the subgroups \mathcal{F}_n^* and \mathcal{F}_n).

Let G be any group, let $\varphi : \mathcal{B}_n \rightarrow G$ be a homomorphism and $\bar{\varphi} : \mathcal{F}_n^* \rightarrow G$ the induced homomorphism by restriction. Then :

(i) If $\varphi : \mathcal{B}_n \rightarrow G$ is cyclic, then $\bar{\varphi} : \mathcal{F}_n^* \rightarrow G$ is trivial.

(ii) If $\bar{\varphi} : \mathcal{F}_n^* \rightarrow G$ is cyclic, then $\varphi : \mathcal{B}_n \rightarrow G$ is cyclic.

Similarly, if we are given an action of \mathcal{B}_n on any set \mathcal{E} and its induced action of \mathcal{F}_n^* on \mathcal{E} , then:

(iii) If the action of \mathcal{B}_n is cyclic, then the action of \mathcal{F}_n^* is trivial.

(iv) If the action of \mathcal{F}_n^* is cyclic, then the action of \mathcal{B}_n is cyclic. □

In order to determine whether an action of \mathcal{B}_n is cyclic or not, we have at our disposal the following proposition due to Artin. We will use it several times to prove Proposition 7.4.

Proposition 7.3 (Artin, cf. [At3]).

Let $n \geq 5$ and \mathcal{E} a set of $n - 1$ elements or less. Then any action of \mathcal{B}_n on \mathcal{E} is cyclic. \square

Proposition 7.4 (All action of \mathcal{B}_n on a \mathcal{B}_n -stable curve simplex is cyclic).

Let \mathcal{A} be a curve simplex in $\text{Curv}(\Sigma)$ stable by the action of \mathcal{B}_n via ρ on $\text{Curv}(\Sigma)$. Then the actions of \mathcal{B}_n induced by ρ on \mathcal{A} , on $\text{Sub}_{\mathcal{A}}(\Sigma)$ and on $\text{Bndy}(\Sigma_{\mathcal{A}})$ are cyclic.

Proof. Let us recall the statement. Let n be an even integer greater than or equal to 6, Σ a surface $\Sigma_{g,b}$ where $g \leq \frac{n}{2}$ and ρ a homomorphism from \mathcal{B}_n to $\mathcal{P}\text{Mod}(\Sigma)$. Let \mathcal{A} be a curve simplex in $\text{Curv}(\Sigma)$ stable by the action of \mathcal{B}_n via ρ on $\text{Curv}(\Sigma)$. We want to show that the actions induced by \mathcal{B}_n on \mathcal{A} , on $\text{Sub}_{\mathcal{A}}(\Sigma)$ and on $\text{Bndy}(\Sigma_{\mathcal{A}})$ are cyclic.

1. Let us show that the action of \mathcal{B}_n on $\text{Sub}_{\mathcal{A}}(\Sigma)$ is cyclic.

Since the action of \mathcal{B}_n on $\text{Curv}(\Sigma)$ preserves \mathcal{A} , the action of \mathcal{B}_n on $\text{Sub}(\Sigma)$ preserves $\text{Sub}_{\mathcal{A}}(\Sigma)$. Let us then consider the action of \mathcal{B}_n on $\text{Sub}_{\mathcal{A}}(\Sigma)$.

The subsurfaces that have some common boundary components with Σ are fixed points of the action of \mathcal{B}_n . Let \mathcal{C} be the set of the subsurfaces of $\text{Sub}_{\mathcal{A}}(\Sigma)$ that have no common boundary component with Σ . For all $S \in \mathcal{C}$, we have $\chi(S) = \chi(\text{for}_{\partial\Sigma}(S))$. Now, the sum $\sum_{S \in \mathcal{C}} \chi(\text{for}_{\partial\Sigma}(S))$ is greater than or equal to $\chi(\Sigma_{g,0}) = 2 - 2g$. Moreover, for all $S \in \mathcal{C}$, $\chi(\text{for}_{\partial\Sigma}(S)) \leq -1$, hence the cardinality of \mathcal{C} satisfies $|\mathcal{C}| \leq 2g - 2$, and finally $|\mathcal{C}| \leq n - 2$. Hence according to Proposition 7.3, \mathcal{B}_n acts cyclicly on the surfaces of \mathcal{C} . Finally, \mathcal{B}_n acts cyclicly on $\text{Sub}_{\mathcal{A}}(\Sigma)$.

2. Let us show that the action of \mathcal{B}_n on \mathcal{A} is cyclic.

Let a be a curve of \mathcal{A} . We are going to study the action of \mathcal{B}_n on $\mathcal{B}_n.a$. We distinguish two cases, whether $|\mathcal{F}_n.a| < n - 2$ or not. In both cases, we will show that the action of \mathcal{B}_n on $\mathcal{B}_n.a$ is cyclic. This will be enough for \mathcal{A} is a union of orbits of curves under the action of \mathcal{B}_n .

2.a) Case where the curve a satisfies $|\mathcal{F}_n.a| < n - 2$.

Let c be a curve in $\mathcal{B}_n.a$ and let γ be an element of \mathcal{B}_n such that $c = \gamma.a$. Since \mathcal{F}_n is normal in \mathcal{B}_n , it follows that $\mathcal{F}_n = \{\gamma\varphi\gamma^{-1}, \varphi \in \mathcal{F}_n\}$. Then we have:

$$|\mathcal{F}_n.c| = |\{\gamma\varphi\gamma^{-1}.c, \varphi \in \mathcal{F}_n\}| = |\{\gamma\varphi.a, \varphi \in \mathcal{F}_n\}| = |\{\varphi.a, \varphi \in \mathcal{F}_n\}| = |\mathcal{F}_n.a| < n - 2. (*)$$

Let us distinguish two sub-cases, whether $n \geq 8$ or $n = 6$:

- When $n \geq 8$, we can apply Proposition 7.3 to the action of \mathcal{F}_n^* (isomorphic to \mathcal{B}_{n-2}) on $\mathcal{F}_n.c$. Then the action of \mathcal{F}_n^* on $\mathcal{F}_n.c$ is cyclic.
- When $n = 6$, we cannot apply Proposition 7.3 to \mathcal{F}_n^* for \mathcal{F}_n^* is isomorphic to the braid group on 4 strands only. We have seen that the orbit of c under \mathcal{F}_n contained at most three elements according to (*). Hence the action of \mathcal{F}_n^* on $\mathcal{F}_n.c$ is described by a homomorphism from \mathcal{B}_4 to \mathfrak{S}_3 . Since such a homomorphism sends the standard generators τ_1, τ_2 and τ_3 of \mathcal{B}_4 on three conjugate elements in \mathfrak{S}_3 , they must be three transpositions, three 3-cycles, or three times the identity.
 - If τ_1, τ_2 and τ_3 are sent on three transpositions, then τ_1 and τ_3 are sent on the same element since they commute;
 - If τ_1, τ_2 and τ_3 are sent on three 3-cycles, then the homomorphism is cyclic for the set of 3-cycles span in \mathfrak{S}_3 a subgroup isomorphic to $\mathbb{Z}/3\mathbb{Z}$;
 - If τ_1, τ_2 and τ_3 are sent on three times the identity, then the homomorphism is trivial.

So whatever this homomorphism from \mathcal{B}_4 to \mathfrak{S}_3 is, the elements τ_1 and τ_3 have the same image. This means that in the group \mathcal{F}_n^* , the elements $\tau_3\tau_1^{-1}$ and $\tau_5\tau_1^{-1}$ have the same action on $\mathcal{F}_n.c$.

Finally, for any $c \in \mathcal{B}_n.a$ and for any even integer n greater than or equal to 6, the action of \mathcal{F}_n^* on $\mathcal{F}_n.c$ is cyclic. Hence the action of \mathcal{F}_n^* on $\mathcal{B}_n.a$ is cyclic. Then, according to Lemma 7.2.(iv), the action of \mathcal{B}_n on $\mathcal{B}_n.a$ is cyclic.

2.b) *Case where the curve a satisfies $|\mathcal{F}_n.a| = m \geq n - 2$.*

Let S and S' be the two subsurfaces (possibly equal) of $\text{Sub}_{\mathcal{A}}(\Sigma)$ containing the curve a in their boundary. Since the action of \mathcal{F}_n is trivial on $\text{Sub}_{\mathcal{A}}(\Sigma)$, the set of curves $\mathcal{F}_n.a$ is included in $\text{Bndy}(S) \cap \text{Bndy}(S')$, so:

- if $S \neq S'$, S and S' are two subsurfaces glued together along at least m curves in Σ , so the surface resulting from the gluing is a subsurface of Σ of genus at least $m - 1$, so $g \geq m - 1$,
- and if $S = S'$, then S is a marked surface and its mark contains m curves, so the surface resulting from the gluing is a subsurface of Σ of genus at last m , so $g \geq m$.

Hence in both cases, $g \geq m - 1$. However on one hand $g \leq \frac{n}{2}$, on the other hand, $m \geq n - 2$. So we get $\frac{n}{2} \geq n - 3$. The only possible integer $n \geq 6$ that satisfies this condition is $n = 6$. Then $g = 3$, $m = n - 2 = 4$, $S \neq S'$, and $\text{Bndy}(S) \cap \text{Bndy}(S')$ is reduced to $\mathcal{F}_n.a$. Moreover, the whole genus of Σ comes from the gluing of S and S' along the curves of $\mathcal{F}_n.a$, so it cannot exist in $\text{Sub}_{\mathcal{A}}(\Sigma)$ another pair of subsurfaces (T, T') such that $\text{Bndy}(T) \cap \text{Bndy}(T')$ contains m curves of \mathcal{A} . Hence $\mathcal{B}_n.a = \mathcal{F}_n.a$. We can then apply Proposition 7.3 to the action of \mathcal{B}_n (a braid group of order 6) on $\mathcal{B}_n.a$ (a simplex of 4 curves): the action of \mathcal{B}_n on $\mathcal{B}_n.a$ is trivial.

3. *Let us show that the action of \mathcal{B}_n on $\text{Bndy}(\Sigma_{\mathcal{A}})$ is cyclic.*

Let a be a curve of \mathcal{A} and let a^+ and a^- be the two boundary components of $\Sigma_{\mathcal{A}}$ coming from the cut along of the curve a . According to step 2., the action of \mathcal{F}_n on \mathcal{A} is trivial, so the action of \mathcal{F}_n^* on $\text{Curv}(\Sigma)$ via ρ fixes the curve a , so the action of \mathcal{F}_n^* on $\text{Bndy}(\Sigma_{\mathcal{A}})$ via ρ preserves $\{a^+, a^-\}$. But \mathcal{F}_n^* is isomorphic to \mathcal{B}_{n-2} and $n - 2 > 2$, so according to Proposition 7.3, the action of \mathcal{F}_n^* on $\{a^+, a^-\}$ is cyclic. Since this is true for all curve a of the set \mathcal{A} , the action of \mathcal{F}_n^* on $\text{Bndy}(\Sigma_{\mathcal{A}})$ is cyclic. So according to Lemma 7.2.(iv), the action of \mathcal{B}_n on $\text{Bndy}(\Sigma_{\mathcal{A}})$ is cyclic. \square

7.2 Curve simplexes which are orbits under \mathcal{J} in $\sigma(\mathcal{G}_0)$ have less than n curves

Recall that $n \geq 6$ is an even number, $\Sigma = \Sigma_{g,b}$ where $g \leq \frac{n}{2}$, and $\rho : \mathcal{B}_n \rightarrow \mathcal{P}\text{Mod}(\Sigma)$ is a noncyclic homomorphism. Let δ be the element $\tau_1\tau_2 \dots \tau_{n-1}$ of \mathcal{B}_n and let \mathcal{J} be the subgroup of \mathcal{B}_n spanned by δ . For all integers $i \in \{0, \dots, n - 1\}$, we have:

$$\delta\tau_i\delta^{-1} = \tau_{i+1}.$$

We deduce from it an action of \mathcal{J} on \mathcal{G}_0 defined as follows: for all integers $i \in \{0, \dots, n - 1\}$, we set:

$$\delta.A_i = \rho(\delta)A_i\rho(\delta)^{-1} = A_{i+1}.$$

We define also an action of \mathcal{J} on $\mathcal{P}(\mathcal{G}_0)$, the power set of \mathcal{G}_0 , by setting for all subsets \mathcal{K} of \mathcal{G}_0 :

$$\delta.\mathcal{K} = \{\delta.A, A \in \mathcal{K}\} = \{\rho(\delta)A\rho(\delta)^{-1}, A \in \mathcal{K}\}.$$

The \mathcal{J} -coloration σ and the associated spectrum sp .

A \mathcal{J} -coloration on a \mathcal{J} -set \mathcal{E} (i.e. a set \mathcal{E} together with an action of \mathcal{J} on \mathcal{E}) is a map col of \mathcal{G}_0 in $\mathcal{P}(\mathcal{E})$ (the power set of \mathcal{E}) compatible with the actions of \mathcal{J} on \mathcal{G}_0 and on \mathcal{E} , i.e. such that for any $A \in \mathcal{G}_0$, we have:

$$\text{col}(\delta.A) = \delta.\text{col}(A).$$

Given a \mathcal{J} -coloration col , we call *spectrum* associated to col the map of \mathcal{E} in $\mathcal{P}(\mathcal{G}_0)$ that associates to any element $e \in \mathcal{E}$ the following set $\{A \in \mathcal{G}_0, \mid e \in \text{col}(A)\}$.

Proposition 7.5. *The restriction of the map σ from \mathcal{G}_0 in $\text{Curv}(\Sigma)$, which associates to any mapping class $A \in \mathcal{G}_0$ its canonical reduction system $\sigma(A) \subset \text{Curv}(\Sigma)$, is a \mathcal{J} -coloration.*

Proof. The map σ is a \mathcal{J} -coloration, since, for all $A \in \mathcal{G}_0$, we have:

$$\begin{aligned} \delta.\sigma(A) &= \{\delta.a, a \in \sigma(A)\} \\ &= \{\rho(\delta)(a), a \in \sigma(A)\} \\ &= \{a', a' \in \sigma(\rho(\delta)A\rho(\delta)^{-1})\} \\ &= \sigma(\delta.A). \end{aligned}$$

□

Notation 7.6. In this section, we will denote by sp the spectrum associated to the \mathcal{J} -coloration σ . Thus by definition, for all $a \in \text{Curv}(\Sigma)$,

$$\text{sp}(a) = \{A \in \mathcal{G}_0 \mid a \in \sigma(A)\}.$$

By considering the action of \mathcal{J} on \mathcal{G}_0 , on $\sigma(\mathcal{G}_0)$ and on $\text{Sub}_{\sigma(\mathcal{G}_0)}(\Sigma)$, we will show the following result.

Proposition 7.11. *Let a be a curve of $\sigma(\mathcal{G}_0)$. Then $\mathcal{J}.a$ contains at most n curves. The limit case $|\mathcal{J}.a| = n$ can be achieved only when $\mathcal{J}.a$ is not a simplex.*

Steps of the proof. The proof of this proposition calls for:

- a lemma on the graphs together with a cyclic action (cf. Lemma 7.7),
- a lemma proposing a first version of Proposition 7.11 (cf. Lemma 7.8),
- a lemma treating a special case (cf. Lemma 7.9),
- a corollary proposing a second version of Proposition 7.11 (cf. Corollary 7.10).

The proof of Proposition 7.11 is on page 69.

In the remainder of this section, we will use the following notation.

Notation. For all integers k and all nonzero integer d , let us denote by $[k]_d$ the remainder of the euclidian division of k by d . For instance, recall that we write A_k instead of $A_{[k]_n}$, and τ_k instead of $\tau_{[k]_n}$.

Lemma 7.7. *Let Γ be a connected nonoriented graph whose number of edges is m . We assume that there exists an action of \mathbb{Z} on Γ , which is compatible with its structure of graph, and which is transitive on the set of edges. Then the pair graph-action $(\Gamma, .)$ is one of the following pairs:*

(a) The graph Γ consists in k vertices and m edges where k is equal to 2 or to a divisor of m (cf. Figure 11):

$$\left\{ \begin{array}{l} \text{vertices: } \mathcal{S} = \{P_i; 0 \leq i \leq k-1\}, \\ \text{edges: } \mathcal{A} = \{a_0, \dots, a_{m-1}\} \text{ and there exists an integer } p \text{ coprime with } k \\ \quad (p = 1 \text{ if } k = 1) \text{ such that for all integers } i \in \{0, \dots, m-1\}, \\ \quad \text{the edge } a_i \text{ joins the vertices } P_{[i]_k} \text{ and } Q_{[i+p]_k}. \text{ Thus, for all integers} \\ \quad i \in \{0, \dots, k-1\}, \text{ the vertices } P_i \text{ and } P_{[i+p]_k} \text{ are joined by the } d \text{ edges} \\ \quad a_{[i]_m}, a_{[i+k]_m}, \dots, a_{[i+(d-1)k]_m}, \text{ where } d = m \text{ if } k = 2 \text{ and } d = \frac{m}{k} \text{ other-} \\ \quad \text{wise.} \end{array} \right.$$

The action associated to this graph Γ is given by $1.P_i = P_{[i+1]_k}$ and $1.a_i = a_{[i+1]_m}$ for all integers $i \in \{0, \dots, k-1\}$.

(b) The graph Γ consists in $k + \ell$ vertices and m edges where k and ℓ are two integers greater than or equal to 1 and coprime and m is a multiple of $k\ell$ (cf. Figure 11):

$$\left\{ \begin{array}{l} \text{vertices: } \mathcal{S} = \mathcal{S}_1 \sqcup \mathcal{S}_2 \text{ where } \mathcal{S}_1 = \{P_0, \dots, P_{k-1}\} \text{ and } \mathcal{S}_2 = \{Q_0, \dots, Q_{\ell-1}\}, \\ \text{edges: } \mathcal{A} = \{a_0, \dots, a_{m-1}\} \text{ such that for all integers } i \in \{0, \dots, m-1\}, \text{ the} \\ \quad \text{edge } a_i \text{ joins the vertices } P_{[i]_k} \text{ and } Q_{[i]_\ell}. \text{ Thus, for all integers } i \in \\ \quad \{0, \dots, k-1\} \text{ and } j \in \{0, \dots, m-1\}, \text{ the vertices } P_i \text{ and } Q_j \text{ are joint} \\ \quad \text{by } d \text{ edges where } d = \frac{m}{k\ell}. \end{array} \right.$$

The action associated to this graph Γ is given by $1.P_i = P_{[i+1]_k}$, by $1.Q_i = Q_{[i+1]_\ell}$ and by $1.a_i = a_{[i+1]_m}$ for all integers $i \in \{0, \dots, k-1\}$ and $j \in \{0, \dots, m-1\}$.

Proof. We check easily that the proposed graphs together with the \mathbb{Z} -actions described in the statement exist (cf. Figure 11) and that the actions are transitive on the edges. Conversely, let us show that under these assumptions, Γ is necessarily one of the announced graphs. We begin by the graphs with just one or two vertices:

- if Γ has only one vertex and consists in a bouquet of m circles, then this is a special of case (a) with $k = 1$;
- if Γ has exactly two vertices and if they are swapped by the \mathbb{Z} -action, then we are in case (a) with $k = 2$;
- if Γ has exactly two vertices and if they are fixed by the \mathbb{Z} -action, then we are in case (b) with $(k, \ell) = (1, 1)$.

Let us focus on the graphs together with a transitive \mathbb{Z} -action on the vertices, having at least 3 vertices. Let m be the number of edges. Since the action is cyclic, $m\mathbb{Z}$ acts trivially on the edges. Notice that any vertex P can be identified by the set of edges ending in P . Indeed, if two distinct vertices were the extremities of the same edges, then by connectedness, the set of vertices of the graph would be reduced to these two vertices, which contradicts our hypotheses. Hence any trivial action on the edges induces a trivial action on the vertices. Thus $m\mathbb{Z}$ acts trivially on the set of vertices. Hence, We can quotient the action of \mathbb{Z} by $m\mathbb{Z}$ and thus get an action of $\mathbb{Z}/m\mathbb{Z}$ on Γ that acts freely and transitively on the edges. The action of $\mathbb{Z}/m\mathbb{Z}$ on the non ordered pairs of vertices $\{p, q\}$ where p and q are the extremities of a same edge is hence transitive as well. We deduce that there exist one or two orbits of vertices under the action of $\mathbb{Z}/m\mathbb{Z}$, whether the extremities of a same edge belong to a same orbit or not.

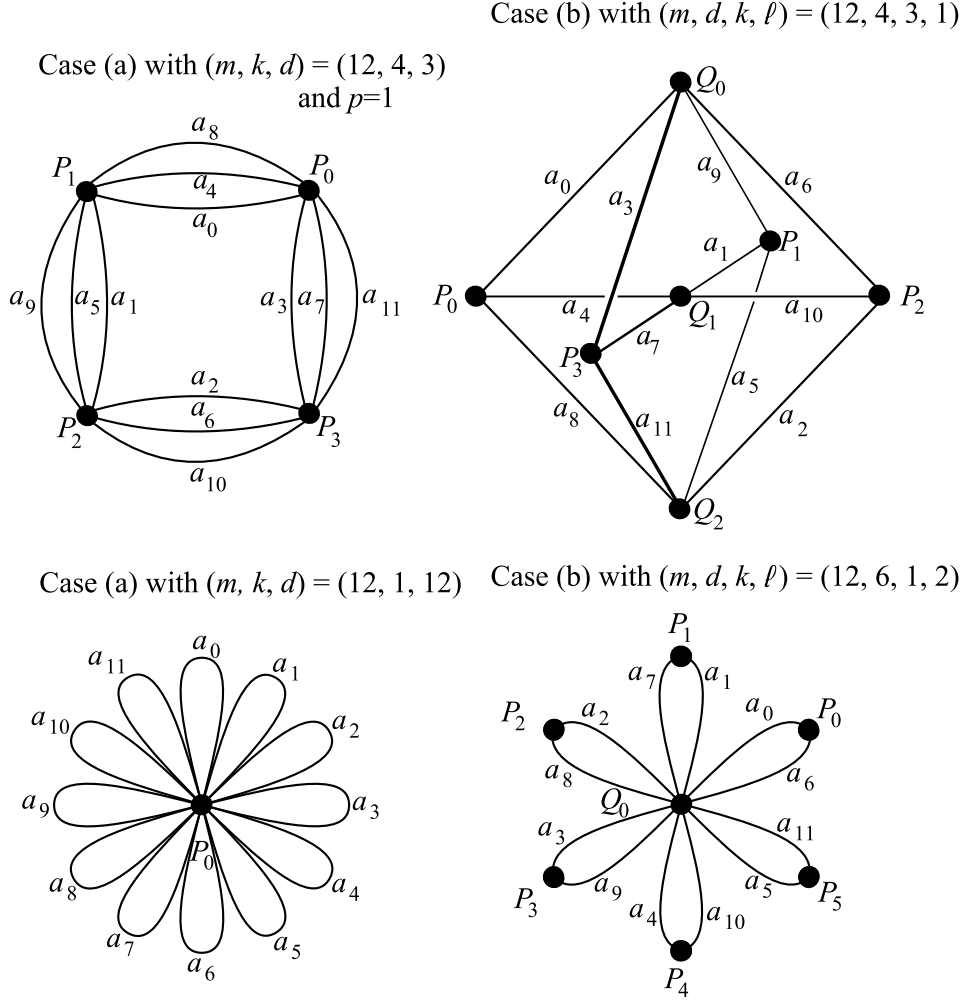

Figure 11: Four examples of graphs with 12 edges, together with a transitive \mathbb{Z} -action on the edges.

Case (a): one single orbit of vertices. Let k be the number of vertices with $k \geq 3$. Since the vertices form a single orbit under the action of $\mathbb{Z}/m\mathbb{Z}$, k must divide m , so the $k\mathbb{Z}/m\mathbb{Z}$ -action on Γ must fix the vertices; and for each pair of vertices (S_1, S_2) linked by some edge, $k\mathbb{Z}/m\mathbb{Z}$ acts freely and transitively on the $d = m/k$ edges whose extremities are S_1 and S_2 . Let $\tilde{\Gamma}$ be the graph obtained from the graph Γ when we identify the edges having the same extremities. The quotient of $\mathbb{Z}/m\mathbb{Z}$ by $k\mathbb{Z}/m\mathbb{Z}$, isomorphic to $\mathbb{Z}/k\mathbb{Z}$, acts on $\tilde{\Gamma}$ and acts transitively on the k edges and the k vertices of the graph $\tilde{\Gamma}$. Let us call P_0, P_1, \dots, P_{k-1} the k vertices of $\tilde{\Gamma}$ so that for all $\ell \in \mathbb{Z}/k\mathbb{Z}$, we have $\ell.P_0 = P_\ell$. Let p be an integer in $\{1, \dots, k-1\}$ such that the vertices P_0 and P_p are joined by an edge. We obtain the left-hand side graph in Figure 12. Notice that k and p are coprime, because the graph $\tilde{\Gamma}$ (and consequently the graph Γ) would not be connected. Let us come back to the graph Γ , we denote its vertices in the same way: we denote by a_0 one of the d edges ending in P_0 and P_p , and for all $\ell \in \{1, 2, \dots, m-1\}$, we denote by a_ℓ the edge $\ell.a_0$ of extremities $P_{[\ell]_k}$ and $P_{[\ell+p]_k}$. We get the right-hand side graph in Figure 12.

Case (b): two orbits of vertices.

Let \mathcal{A} be the set of edges. We assume now that, for all edges $a \in \mathcal{A}$:

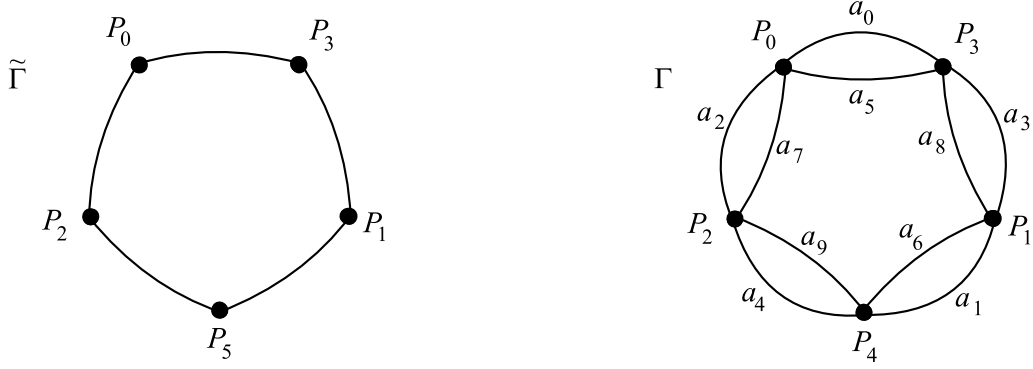

Figure 12: Example of a graph of type (a) where $k = 5$, $\ell = 3$, $d = 2$, $m = 10$.

the extremities of a belong to two different orbits. (1)

Let a_0 be an edge, P_0 and Q_0 the extremities of a_0 . Let \mathcal{S}_1 be the orbit of P_0 and let k be the cardinality of \mathcal{S}_1 . Similarly, let \mathcal{S}_2 be the orbit of Q_0 and let ℓ be the cardinality of \mathcal{S}_2 . We name the vertices of \mathcal{S}_1 and of \mathcal{S}_2 so that for all $i \in \{0, \dots, k-1\}$, $j \in \{0, \dots, \ell-1\}$, and $p \in \mathbb{Z}$,

$$p.P_i = P_{[i+p]_k}, p.Q_j = Q_{[j+p]_\ell}, \text{ and } p.a_i = a_{[i+p]_m}. \quad (2)$$

We have then $\mathcal{S}_1 = \{P_0, \dots, P_{k-1}\}$ and $\mathcal{S}_2 = \{Q_0, \dots, Q_{\ell-1}\}$. The integers k and ℓ must divide m , for the action of the integer m on the vertices is trivial. Since the cardinality of the orbit of P_0 is k , the stabilizer of P_0 is $k\mathbb{Z}/m\mathbb{Z}$. Similarly the stabilizer of Q_0 is $\ell\mathbb{Z}/m\mathbb{Z}$. We deduce the following equalities between sets:

$$\begin{cases} \{a \in \mathcal{A} \mid P_0 \text{ is an extremity of } a\} = (k\mathbb{Z}/m\mathbb{Z}).a_0, \\ \{a \in \mathcal{A} \mid Q_0 \text{ is an extremity of } a\} = (\ell\mathbb{Z}/m\mathbb{Z}).a_0, \end{cases} \quad (3)$$

We will say that two edges are *adjacent* if they share at least one extremity in common. Then:

$$\{a \in \mathcal{A} \mid a \text{ is adjacent to } a_0\} = (k\mathbb{Z}/m\mathbb{Z} \cup \ell\mathbb{Z}/m\mathbb{Z}).a_0. \quad (4)$$

Since the action of $\mathbb{Z}/m\mathbb{Z}$ is transitive on the edges, equality (4) holds not only for a_0 , but for all the edges in Γ . Then, given a path of edges starting with the edge a_0 , namely a finite sequence of edges $(a'_0 = a_0, a'_1, \dots, a'_r)$, $r \geq 1$, such that $a'_i \cap a'_{i+1} \neq \emptyset$ for all $i \leq r-1$, the last edge a'_r must satisfy:

$$a'_r \in (k\mathbb{Z}/m\mathbb{Z} + \ell\mathbb{Z}/m\mathbb{Z}).a'_0.$$

But Γ is connected, hence any edge of Γ can be seen as the last edge of some path of edges starting with a , hence $k\mathbb{Z}/m\mathbb{Z} + \ell\mathbb{Z}/m\mathbb{Z} = \mathbb{Z}/m\mathbb{Z}$. Since $k < m$ and $\ell < m$, it follows that:

$$k \text{ and } \ell \text{ are coprime.} \quad (5)$$

Let us determine d , the number of edges having the same extremities as a_0 (cf. Figure 13). According to (3), the set of edges is $(k\mathbb{Z}/m\mathbb{Z}).a \cap (\ell\mathbb{Z}/m\mathbb{Z}).a$, so, using (5) we get:

$$\{\text{edges of extremities } P_0 \text{ and } Q_0\} = ((k\ell)\mathbb{Z}/m\mathbb{Z}).a_0, \quad (6)$$

Hence we count exactly $d = \frac{m}{k\ell}$ edges (including a_0) having the same extremities as a_0 .

From m , k , ℓ , we can now describe completely Γ and the action of $\mathbb{Z}/m\mathbb{Z}$ on Γ . For all $i \in \{0, \dots, k-1\}$ and all $j \in \{0, \dots, \ell-1\}$, according to the Chinese theorem, there exists a unique integer $u \in \{0, \dots, k\ell-1\}$ such that u is congruent to i modulo k and to j modulo ℓ . Then according to (6):

$$\begin{aligned} \{\text{edges of extremities } P_i \text{ and } Q_j\} &= \{(u + pk\ell).a_0, 0 \leq p \leq d-1\} \\ &= \{a_u, a_{u+k\ell}, \dots, a_{u+(d-1)k\ell}\}. \end{aligned} \quad (7)$$

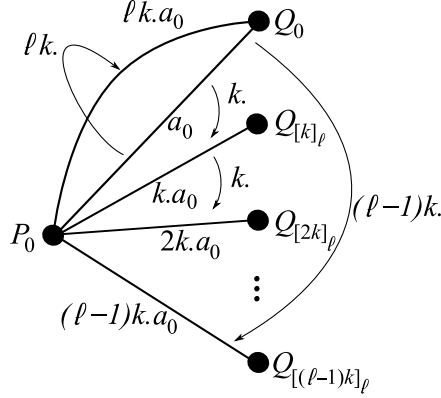

Figure 13: Action of \mathbb{Z} on a . The points Q_1, Q_2, \dots, Q_ℓ form the orbit of Q_1 .

Thus we get the $m = dk\ell$ edges of Γ . Such a graph is characterized by the triple (m, k, ℓ) or equivalently by the triple (d, k, ℓ) . \square

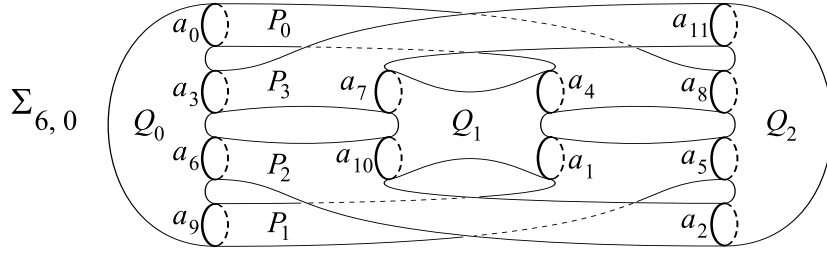

Figure 14: A simplex of 12 curves $\{a_i, i \in \mathbb{Z}/12\mathbb{Z}\}$ in $\Sigma_{6,0}$, and a \mathbb{Z} -action in $\text{Mod}(\Sigma_{6,0})$ such that for all $k \in \mathbb{Z}$ and all $i \in \{0, \dots, 11\}$:

$$\begin{aligned} k.a_i &= a_{[i+k]_{12}}, \\ k.P_i &= P_{[i+k]_4}, \\ k.Q_i &= Q_{[i+k]_3}. \end{aligned}$$

Lemma 7.8. *Let Σ be a surface $\Sigma_{g,b}$. Let \mathcal{A} be a simplex of at least three curves in Σ . We assume that there exists a homomorphism $\mathbb{Z} \rightarrow \mathcal{P}\text{Mod}(\Sigma)$ whose image preserves \mathcal{A} and that induces a transitive action on the curves of \mathcal{A} . Then the cardinality of \mathcal{A} is smaller than or equal to $2g$. The equality $|\mathcal{A}| = 2g$ can happen only if $g = 6$ and $b = 0$. In this case, the position of the curves of \mathcal{A} and the action of \mathbb{Z} on these curves are unique, up to homeomorphism; this case is represented in Figure 14, where the action of \mathbb{Z} is given as follows: let us denote by $\{a_i, 0 \leq i \leq 11\}$ the set of curves \mathcal{A} , and by $\{P_0, P_1, P_2, P_3\}$ and $\{Q_0, Q_1, Q_2\}$ the seven subsurfaces of $\text{Sub}_{\mathcal{A}}(\Sigma)$, then for all $k \in \mathbb{Z}$ and all $i \in \{0, \dots, 11\}$, we have $k.a_i = a_{[i+k]_{12}}$, $k.P_i = P_{[i+k]_4}$, $k.Q_i = Q_{[i+k]_3}$.*

Proof.

1. Let us show Lemma 7.8 in the case where $b = 0$.

Let Γ be the graph $\Gamma(\Sigma; \mathcal{A})$. The action of \mathbb{Z} on Σ induces an action of \mathbb{Z} on Γ that is transitive on the edges. Then Γ is one of the graphs described by Lemma 7.7. We are going to

bound the cardinality $|\mathcal{A}|$ as a function of g , the genus of Σ . To do so, according to Lemma 7.7, we denote by:

- $m = |\mathcal{A}|$ the number of curves of \mathcal{A} , also equal to the number of edges of Γ ,
- \mathcal{S} the set of vertices of Γ ,
- c the number of independent cycles of Γ , we have: $c = 1 + |\mathcal{A}| - |\mathcal{S}|$,
- h the number of vertices in Γ of degree 1 or 2.

Let us recall that $b = 0$, hence the vertices of degree 1 or 2 correspond in Σ to connected components having only one or two boundary components. Therefore, these connected components must be of nonzero genus, whence $g \geq c + h$. Moreover, by hypothesis, $m \geq 3$.

In the case (a) of Lemma 7.7, we set $k = |\mathcal{S}|$. Then:

- if $k = 1$, then $c = m$, but $g \geq c$, so $m \leq g$. Therefore, $m < 2g$;
- if $k = 2$, then $c = 1 + m - 2 = m - 1$, whence $g \geq c = m - 1 > \frac{m}{2}$, so $m < 2g$;
- if $k \geq 3$, we then set $d = \frac{m}{k}$. We have $c = 1 + m - k = 1 + \frac{(d-1)m}{d}$. Hence:
 - if $d = 1$, all the vertices are of degree 2, hence $h = k = m$ and we have: $g \geq c + k = 1 + m$, so $m < 2g$;
 - if $d \geq 2$, then: $g \geq c \geq 1 + \frac{m}{2}$, so $m < 2g$.

In the case (b) of Lemma 7.7, let k and ℓ be the cardinalities of the two orbits \mathcal{S}_1 and \mathcal{S}_2 of vertices and $d = \frac{m}{k\ell}$. Even if it means swapping \mathcal{S}_1 and \mathcal{S}_2 , we can assume that $k \leq \ell$. Let us recall that k and ℓ are coprime. For each triple (d, k, ℓ) that respects these two conditions, let us compare m and $2g$.

- if $(d, k, \ell) = (1, 1, m)$, then the ℓ vertices of \mathcal{S}_2 are of degree 1, so $h = \ell = m$, so $g \geq h = \ell = m$, so $m < 2g$;
- if $(d, k, \ell) = (1, 2, \frac{m}{2})$, then $c = 1 + m - (2 + \frac{m}{2}) = \frac{m}{2} - 1$. Now, the $\ell = \frac{m}{2}$ vertices of \mathcal{S}_2 are of degree 2, so $h = \frac{m}{2}$ and $g \geq c + h = m - 1$, so $m < 2g$;
- if $(d, k, \ell) = (1, 3, 4)$, then $c = 6$ and $m = 12$, so $g \geq \frac{m}{2}$, so $m \leq 2g$;
- if $(d, k, \ell) = (1, 3, 5)$, then $c = 8$ and $m = 15$, so $g \geq \frac{m+1}{2}$, so $m < 2g$;
- if $(d, k, \ell) = (1, k, \ell)$ with $k = 3$ and $\ell \geq 7$, or $k \geq 4$ and $\ell \geq 5$ (recall that k and ℓ are coprime), then $c = 1 + m(1 - \frac{1}{\ell} - \frac{1}{k})$. Then $\frac{1}{\ell} + \frac{1}{k} \leq \frac{1}{2}$, so $g \geq c \geq 1 + \frac{m}{2}$, so $m < 2g$;
- if $(d, k, \ell) = (2, 1, \frac{m}{2})$, then a vertex is of degree m and $\frac{m}{2}$ vertices are of degree 2, so $h = \frac{m}{2}$ and $c = 1 + m - (1 + \frac{m}{2})$, so $g \geq h + c = m$, so $m < 2g$;
- if $(d, k, \ell) = (d, 1, \frac{m}{d})$ with $d \geq 3$, then we have $d + 1$ vertices and dm edges. So $c = 1 - (1 + \frac{m}{d}) + (dm) = \frac{d-1}{d}m$. But $\frac{d-1}{d} > \frac{1}{2}$, so $g \geq c \geq \frac{m}{2}$ and finally, $m < 2g$;
- if $(d, k, \ell) = (m, 1, 1)$, then $g \geq c = 1 + m - 2 = m - 1$. But $m \geq 3$, so $m < 2g$;

- if (d, k, ℓ) satisfies $d \geq 2$, $k \geq 2$ and $\ell \geq 2$, we have $c = 1 + m - (k + \ell)$. But $k\ell = \frac{m}{d} \leq \frac{m}{2}$, so $k + \ell \leq \frac{m}{2}$ (indeed, a sum of integers is always smaller than or equal to a product of these two integers as soon as they are greater than or equal to 2), so $g \geq c \geq 1 + \frac{m}{2}$, so $m < 2g$.

Finally, in all the cases, $m \leq 2g$. The equality case comes only in the case (b), when the triple (d, k, ℓ) equals $(1, 3, 4)$, cf. Figure 11, top-right-hand graph. The corresponding surface together with the curves of \mathcal{A} , indexed in a self-understanding way with respect to the action of \mathbb{Z} , is the surface $\Sigma_{6,0}$ depicted in Figure 14.

2. *Let us show Lemma 7.8 in the case where $b > 0$.*

Let us assume that we have a surface Σ together with a simplex \mathcal{A} of at least three curves, and a homomorphism φ of \mathbb{Z} to $\mathcal{P}\text{Mod}(\Sigma)$ whose image preserves \mathcal{A} and induces on its curves a transitive action. Then, after having applied the map sq to Σ and \mathcal{A} , and after having replaced φ by $\text{sq}^* \circ \varphi$, we have boiled down to the case without boundary. Since the simplex \mathcal{A} contains at least three curves and since the action of \mathbb{Z} induced by φ is transitive on \mathcal{A} , we can apply Proposition 4.9: \mathcal{A} and $\text{sq}(\mathcal{A})$ consist in the same number of curves. Hence $|\mathcal{A}| \leq 2g$, and if $|\mathcal{A}| = 2g$, then $|\text{sq}(\mathcal{A})| = 2g$, so according to what we just saw in the case without boundary, the only pair $(\text{sq}(\Sigma), \text{sq}(\mathcal{A}))$ satisfying $|\text{sq}(\mathcal{A})| = 2g$ is the one of Figure 14. Now, according to Proposition 4.9, for all subsurface $S \in \text{Sub}_{\mathcal{A}}(\Sigma)$, we have:

$$\text{sq}(\varphi(1)(S)) = \text{sq}^*(\varphi(1))(\text{sq}(S)).$$

In the case without boundary, no subsurface is preserved by $\text{sq}^*(\varphi(1))$, so no subsurface is preserved by $\varphi(1)$ in the case with boundary. This is absurd for a subsurface of $\text{Sub}_{\mathcal{A}}(\Sigma)$ having some common boundary components with Σ is preserved by any mapping class of $\mathcal{P}\text{Mod}_{\mathcal{A}}(\Sigma)$. Hence in a surface of genus 6 with boundary, the curves of \mathcal{A} cannot be arranged as in Figure 14. Therefore, when the boundary is not empty, we have $|\mathcal{A}| < 2g$. \square

In order to better understand the situation depicted in Figure 14, when the role of \mathcal{A} is played by the set of curves $\sigma(\mathcal{G}_0)$, coming from a homomorphism ρ from \mathcal{B}_{12} to $\text{Mod}(\Sigma_{6,0})$, we prove the following lemma:

Lemma 7.9. *Let Σ be the surface $\Sigma_{6,0}$ and let ρ be a homomorphism from \mathcal{B}_{12} to $\text{Mod}(\Sigma)$. We assume that there exists a simplex \mathcal{A} of 12 curves in $\sigma(\mathcal{G}_0)$ such that a subgroup of \mathcal{J} acts transitively on \mathcal{A} . Then ρ is cyclic.*

Proof. Let \mathcal{A} be a simplex of 12 curves in $\sigma(\mathcal{G}_0)$ such that a subgroup \mathcal{K} of $\mathcal{J} = \langle \delta \rangle_{\mathcal{B}_{12}}$ acts transitively on it. We want to show that ρ is then cyclic. To do so, we assume that ρ is not cyclic and we look for a contradiction (actually, we will use the fact that ρ is not cyclic to show that ρ is cyclic! This is the expected contradiction).

Let γ be a generator of \mathcal{K} and let k be an integer such that $\gamma = \delta^k$. Even if it means replacing \mathcal{A} by $\delta^\ell \mathcal{A}$ where ℓ is an integer, we can assume that $\mathcal{A} \cap \sigma(A_0)$ is not empty. Let a_0 be one of the curves of $\mathcal{A} \cap \sigma(A_0)$. For all $i \in \{1, \dots, 11\}$, let us denote by a_i the curve $\gamma^i \cdot a_0$. It belongs to $\sigma(A_{ki})$. Then \mathcal{A} is the set $\{a_j, 0 \leq j \leq 11\}$, and the surface Σ together with the curves of \mathcal{A} and with the action of \mathcal{K} on Σ and on \mathcal{A} is (up to homeomorphism) the surface together with the 12 curves and with the \mathbb{Z} -action depicted in Figure 14.

1. *Let us show that k is coprime with 3.*

Let us argue by contradiction. Let us assume that k is a multiple of 3 and let us set $k' = \frac{k}{3}$. Let us then set $\mathcal{L} = \langle \delta^{2k'} \rangle$. We are going to show that $\mathcal{L}.a_0$ contains 18 curves, then to show that this is absurd. First, we check that:

- $a_6 = \gamma^6.a_0 \neq a_0$, so $\delta^{6k}.a_0 \neq a_0$, so $(\delta^{2k'})^9.a_0 \neq a_0$;
- $a_8 = \gamma^8.a_0 \neq a_0$, so $\delta^{8k}.a_0 \neq a_0$, so $(\delta^{2k'})^{12}.a_0 \neq a_0$;
- $\gamma^{12}.a_0 = a_0$, so $\delta^{12k}.a_0 = a_0$, so $(\delta^{2k'})^{18}.a_0 = a_0$.

Consequently, $\mathcal{L}.a_0$ contains 18 curves. Furthermore, $\mathcal{L}.a_0$ is included in $\sigma(A_0) \cup \sigma(A_2) \cup \dots \cup \sigma(A_{n-2})$, which is a simplex, for the group $\langle A_0, A_2, \dots, A_{n-2} \rangle$ is abelian. Finally, $\mathcal{L}.a_0$ is a simplex of 18 curves in Σ , but this is absurd because as it is well known, the greatest simplex in Σ contains $3g - 3 + b = 15$ curves. Hence k is coprime with 3.

2. Let us show that $I(\mathcal{A}, \sigma(\mathcal{G}_0)) = 0$.

Let us argue by contradiction. We assume that there exists a curve c of $\sigma(\mathcal{G}_0)$ that intersects a curve of \mathcal{A} . Since $\sigma(\mathcal{G}_0)$ is stable by \mathcal{K} , we can assume without loss of generality that c belongs to $\sigma(A_{\pm 1})$ and intersects a_0 . According to Figure 14, there exists a pair of pants P in Σ whose boundary components are $a_0, a_4 = \gamma^4.a_0$ and $a_8 = \gamma^8.a_0$. But the curves a_4 and a_8 belong to $\sigma(\gamma^4.A_0) \cup \sigma(\gamma^{8k}.A_0)$, hence belong to $\sigma(\delta^{4k}.A_0) \cup \sigma(\delta^{8k}.A_0)$. Now, k is coprime with 3 according to step 1., so $4k$ and $8k$ belong to $4\mathbb{Z} \setminus 12\mathbb{Z}$. Hence $\sigma(\delta^{4k}.A_0) \cup \sigma(\delta^{8k}.A_0) \subset \sigma(A_4) \cup \sigma(A_8)$. Moreover $A_{\pm 1}$ commutes with A_4 and A_8 , so the only boundary component of P that c intersects is a_0 , and neither a_4 nor a_8 . Let us consider now the image of this situation by γ^4 . The pair of pants P is stable by γ^4 , but c is sent on a curve $\gamma^4.c$ that intersects only a_4 , cf. Figure 15. Because of a lack of room in the pair of pants P , these two curves c and $\gamma^4.c$ must intersect. Yet c and $\gamma^4.c$ belong respectively to $\sigma(A_{\pm 1})$ and $\sigma(A_{4k\pm 1}) \cup \sigma(A_{8k\pm 1})$. Since $A_{\pm 1}$ commutes with $A_{4k\pm 1}$ and $A_{8k\pm 1}$, the curves c and $\gamma^4.c$ cannot intersect: this is a contradiction.

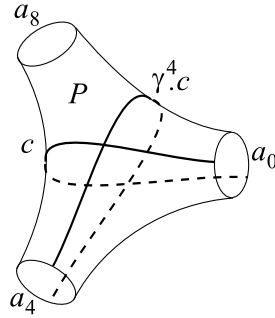

Figure 15: The curves c and $\gamma^4.c$ must intersect in P .

3. Let us show that $\mathcal{A} = \mathcal{J}.a_0$; in other words, everything happens as if $\mathcal{K} = \mathcal{J}$.

Let us denote by $\delta\mathcal{K}$ the set $\{\delta\xi, \xi \in \mathcal{K}\}$ and by $\delta.\mathcal{A}$ the set $\{\delta.x, x \in \mathcal{A}\}$. Let us assume that $\mathcal{K} \neq \mathcal{J}$. Then it is clear that \mathcal{K} and $\delta\mathcal{K}$ do not share any element in common. Since \mathcal{A} and $\delta.\mathcal{A}$ are the orbits of curves under the action of \mathcal{K} , we have $\mathcal{A} = \delta.\mathcal{A}$ or $\mathcal{A} \cap \delta.\mathcal{A} = \emptyset$. If $\mathcal{A} \cap \delta.\mathcal{A} = \emptyset$, then $\mathcal{A} \cup \delta.\mathcal{A}$ contains 24 curves. In addition, according to step 2., we have $I(\sigma(\mathcal{G}_0), \mathcal{A}) = 0$, so $\delta.\mathcal{A} \subset \sigma(\mathcal{G}_0)$, so $I(\delta.\mathcal{A}, \mathcal{A}) = 0$, so $\mathcal{A} \cup \delta.\mathcal{A}$ is a simplex. Finally, $\mathcal{A} \cup \delta.\mathcal{A}$ is a simplex of 24 curves. But this is absurd for in Σ , the largest simplex contains $3g - 3 + b = 15$ curves. Hence

$\mathcal{A} = \delta.\mathcal{A}$. Then \mathcal{A} is stable by \mathcal{J} , so \mathcal{A} (namely $\mathcal{K}.a_0$) is equal to $\mathcal{J}.a_0$. So $\mathcal{K}.a_0 = \mathcal{J}.a_0$. So everything happens as if $\mathcal{K} = \mathcal{J}$ (actually we have proven that k is coprime with 12).

Notation.

- Let D be the mapping class $\rho(\delta)$.
- For all integers $i \in \{1, \dots, 11\}$, let a_i be the curve $D^i(a_0)$ so that $a_i \in \sigma(A_i)$. According to step 3., we have the equality $\mathcal{A} = \{a_i, 0 \leq i \leq 11\}$.
- Let Q_0 (respectively Q_1 , resp. Q_2) be the subsurface of $\text{Sub}_{\mathcal{A}}(\Sigma)$ that is bounded by the curves a_0, a_3, a_6 and a_9 (resp. a_1, a_4, a_7 and a_{10} , resp. a_2, a_5, a_8 and a_{11}), cf. Figure 14.

4.a) *Let us show that $\sigma(\mathcal{G}_0) \subset \mathcal{A} \cup \text{Curv}(Q_0 \cup Q_1 \cup Q_2)$ and for all $x \in \sigma(\mathcal{G}_0) \setminus \mathcal{A}$, we have $D^3(x) = x$.*

If there exists a curve x belonging to $\sigma(\mathcal{G}_0) \setminus \mathcal{A}$, the curve x does not intersect any curve of \mathcal{A} according to step 2.. Now, all the subsurfaces of $\text{Sub}_{\mathcal{A}}(\Sigma)$, except Q_0, Q_1 and Q_2 , are some pairs of pants, so x belongs to $\text{Curv}(Q_0), \text{Curv}(Q_1)$, or $\text{Curv}(Q_2)$. Even if it means considering $D(x)$ or $D^2(x)$ instead of x , we can assume that x belongs to $\text{Curv}(Q_0)$. Then $D^3(x)$ belongs to $\text{Curv}(Q_0)$ as well. Let i be an integer of $\{0, \dots, 11\}$ such that $x \in \sigma(A_i)$. Then $D^3(x)$ belongs to $\sigma(A_{i+3})$. Since A_i and A_{i+3} commute, x and $D^3(x)$ cannot intersect. But $\text{Curv}(Q_0)$ does not contain any simplex of two curves, so $D^3(x) = x$.

4.b) *Let us show that $\sigma(D) \subset \mathcal{A} \cup \text{Curv}(Q_0 \cup Q_1 \cup Q_2)$ and for all $x \in \sigma(D) \setminus \mathcal{A}$, we have $D^3(x) = x$.*

According to step 3., $\mathcal{A} = \mathcal{J}.a_0$, so \mathcal{A} is stable by the mapping class D , so the curves of \mathcal{A} are reduction curves of D . Hence the curves of $\sigma(D)$ do not intersect the curves of \mathcal{A} . Since all the subsurfaces of $\text{Sub}_{\mathcal{A}}(\Sigma)$ except Q_0, Q_1 and Q_2 are pairs of pants, the curves of $\sigma(D)$ belong to $\mathcal{A} \cup \text{Curv}(Q_0) \cup \text{Curv}(Q_1) \cup \text{Curv}(Q_2)$. Moreover, for all $i \in \{0, 1, 2\}$, the surface Q_i does not contain any simplex of more than one curve, since in the case of Q_i , we have $3g - 3 + b = 1$. Hence $\sigma(D) \cap \text{Curv}(Q_i)$ is empty or is reduced to one curve. Now, D^3 preserves $\sigma(D) \cap \text{Curv}(Q_i)$, so D^3 must preserve this curve.

5. *Let us show that $\sigma(\mathcal{G}_0) \setminus \mathcal{A} \subset \sigma(D) \setminus \mathcal{A}$, and let us describe $\sigma(D) \setminus \mathcal{A}$: if $\sigma(D) \setminus \mathcal{A}$ is not empty, then $\sigma(D) \setminus \mathcal{A}$ contains three curves, one included in Q_0 which we denote by c_0 , and two other curves $c_1 = D(c_0)$ and $c_2 = D^2(c_0)$ included respectively in Q_1 and Q_2 .*

According to the action of D on \mathcal{A} , D permutes Q_0, Q_1 and Q_2 , whereas D^3 preserves each of them. Let us denote by $\widehat{D^3}$ the restriction of D^3 on Q_0 : $\widehat{D^3}$ belongs to $\text{Mod}(Q_0)$. Let us focus on $\sigma(D) \setminus \mathcal{A}$, depending on the nature of $\widehat{D^3}$, and let us show that $\sigma(\mathcal{G}_0) \setminus \mathcal{A} \subset \sigma(D) \setminus \mathcal{A}$.

- If $\widehat{D^3}$ is pseudo-Anosov, then so is $(\widehat{D^3})^4$. But D^{12} is in the center of $\rho(\mathcal{B}_{12})$, so all the curves of $\sigma(\rho(\mathcal{B}_{12}))$ are some reduction curves of D^{12} . Therefore Q_0 do not contain any curve of $\sigma(\rho(\mathcal{B}_{12}))$. Thus,

$$\sigma(\mathcal{G}_0) \setminus \mathcal{A} \subset \sigma(D) \setminus \mathcal{A} = \emptyset.$$

- If $\widehat{D^3}$ is periodic, then $\widehat{D^3}$ would be the isotopy class of a positive diffeomorphism of finite order according to Kerckhoff's Theorem. Now, according to Kerckjartò's Theorem (cf. [Kj]), such a diffeomorphism is conjugate to a rotation of the sphere. But if such a

rotation, of order 4 here, preserves a curve c , it preserves also each of both hemispheres bounded by this curve. Hence one of these two hemispheres contains the orbit of a_0 , that is to say the four boundary components a_0, a_3, a_6, a_9 , so the other hemisphere is homeomorphic to a disk. Hence the curve c bounds a disk. Hence $\widehat{D^3}$ does not preserve any curve of $\mathcal{C}urv(Q_0)$. Hence according to step 4.a) step 4.b),

$$\sigma(\mathcal{G}_0) \setminus \mathcal{A} \subset \sigma(D) \setminus \mathcal{A} = \emptyset.$$

- If $\widehat{D^3}$ is reducible, let us denote by c_0 an essential reduction curve of $\widehat{D^3}$. Then $\sigma(\widehat{D^3}) = \{c_0\}$ according to step 4.b). Hence $\mathcal{J}.c_0$ is a set of three curves, one in Q_0 , one in Q_1 and one in Q_2 . Now, any curve of $\mathcal{C}urv(Q_0)$ different from c_0 intersects c_0 , so by definition of $\sigma(\widehat{D^3})$, this curve is not a reduction curve of $\widehat{D^3}$, hence it cannot be preserved by $\widehat{D^3}$. So according to step 4., $\sigma(\mathcal{G}_0) \cap \mathcal{C}urv(Q_0) \subset \{c_0\}$. Hence if $\widehat{D^3}$ is reducible, we have:

$$\sigma(\mathcal{G}_0) \setminus \mathcal{A} \subset \sigma(D) \setminus \mathcal{A} = \mathcal{J}.c_0 = \{c_0, c_1, c_2\},$$

where $c_1 = D(c_0)$ and $c_2 = D^2(c_0)$.

In order to discuss later (in steps 7. and 8.) about the stability of \mathcal{A} under the action of \mathcal{B}_{12} , we are going to study in step 6. the stability of $\mathcal{J}.c_0$ under the action of \mathcal{B}_{12} . Of course the set $\mathcal{J}.c_0$ has some meaning if the curve c_0 is defined, that is to say when $\sigma(D) \setminus \mathcal{A} \neq \emptyset$ according to step 5..

6. *Let us show that if $\sigma(D) \setminus \mathcal{A} \neq \emptyset$, then the action of \mathcal{B}_{12} via ρ on $\mathcal{C}urv(\Sigma)$ preserves $\mathcal{J}.c_0$.*

By definition of c_0 according to step 5., c_0 belongs to $\sigma(D)$. Since $\sigma(D)$ is stable by D , $\sigma(D)$ contains $\mathcal{J}.c_0$, and if a_0 belongs to $\sigma(D)$, then $\sigma(D)$ contains $\mathcal{J}.a_0$ that is equal to \mathcal{A} , whereas if a_0 does not belong to $\sigma(D)$, then $\sigma(D) \cap \mathcal{A} = \emptyset$. Now, according to step 5., $\sigma(D)$ is included in $\mathcal{J}.c_0 \cup \mathcal{A}$. Hence $\sigma(D) = \mathcal{J}.c_0$ or $\sigma(D) = \mathcal{J}.c_0 \cup \mathcal{A}$. But, for all $\xi \in \mathcal{B}_{12}$, the mapping class $\rho(\xi)$ commutes with D^{12} , so $\rho(\xi)(\sigma(D^{12})) = \sigma(D^{12})$, and so $\rho(\xi)(\sigma(D)) = \sigma(D)$, since $\sigma(D^{12}) = \sigma(D)$. Hence the action of \mathcal{B}_{12} via ρ on $\mathcal{C}urv(\Sigma)$ preserves the curves of $\sigma(D)$. Then if $\sigma(D) = \mathcal{J}.c_0$, we have shown that the action of \mathcal{B}_{12} via ρ on $\mathcal{C}urv(\Sigma)$ preserves $\mathcal{J}.c_0$. We still have to study the case where $\sigma(D) = \mathcal{J}.c_0 \cup \mathcal{A}$. We are going to show that:

$$\text{Any mapping class that preserves } \mathcal{J}.c_0 \cup \mathcal{A} \text{ preserves } \mathcal{J}.c_0 \text{ and preserves } \mathcal{A}. \quad (1)$$

Since the action of \mathcal{B}_{12} via ρ on $\mathcal{C}urv(\Sigma)$ preserves $\sigma(D) = \mathcal{J}.c_0 \cup \mathcal{A}$, it preserves $\mathcal{J}.c_0$. So, proving (1) is enough to show step 6..

Let us show assertion (1). The curve c_0 lies in Q_0 , is separating in Q_0 and so induces a partition of $\text{Bndy}(Q_0)$ in two subsets: the boundary components located on an edge of c_0 and the boundary components located on the other one. Since the curve c_0 is stable by D^3 , this partition must be stable by D^3 . The boundary components of Q_0 are the curves a_0, a_3, a_6, a_9 , and their images by D^3 are respectively a_3, a_6, a_9, a_0 , so this partition can only be $\{a_0, a_6\} \sqcup \{a_3, a_9\}$. Indeed, it is clear that the two other partitions $\{a_0, a_3\} \sqcup \{a_6, a_9\}$ and $\{a_0, a_9\} \sqcup \{a_3, a_6\}$ are not stable by D^3 . Let us consider the graph $\Gamma(\Sigma, \sigma(D))$, cf. Figure 16 on the right-hand side. We see that the smallest injective cycle of edges containing a_0 contains four edges, for example the cycle a_0, a_4, a_{10}, a_6 , whereas the smallest injective cycles of edges containing c_0 contains six edges, for example the cycle $a_0, c_0, a_3, a_{11}, c_2, a_8$. Then, any mapping class preserving $\mathcal{J}.c_0 \cup \mathcal{A}$ induces an action on the graph $\Gamma(\Sigma, \mathcal{J}.c_0 \cup \mathcal{A})$, but cannot swap in this graph two edges such that a_0 and c_0 , since they have different combinatoric properties, as we

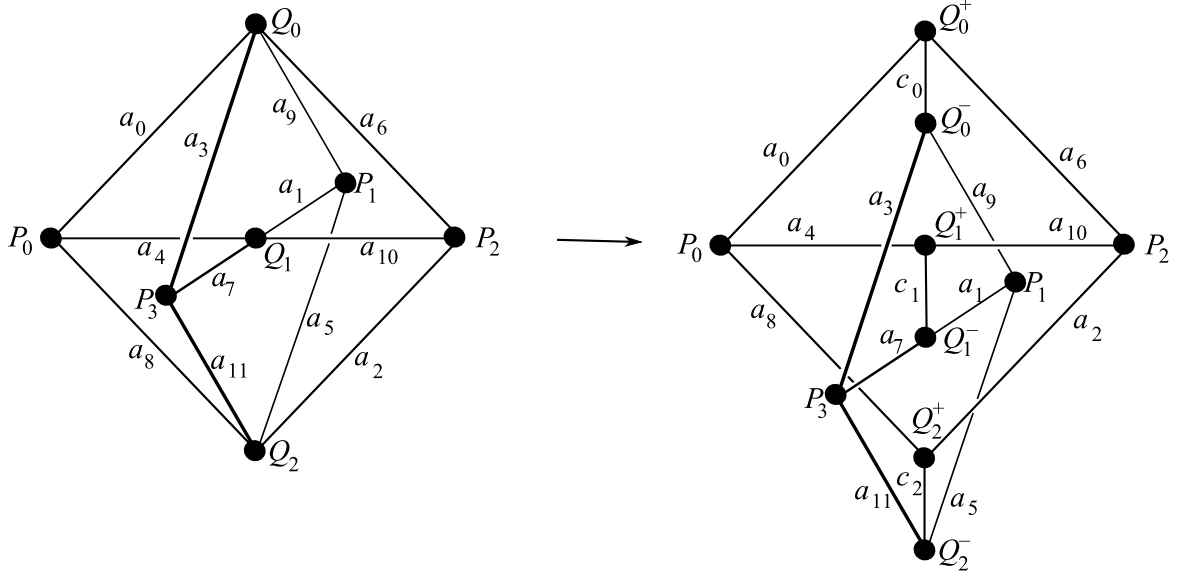

Figure 16: The graph $\Gamma(\Sigma, \mathcal{A})$ on the left-hand side, the graph $\Gamma(\Sigma, \mathcal{J}.c_0 \cup \mathcal{A})$ on the right-hand side.

have just seen it. Hence any mapping class that preserves $\mathcal{J}.c_0 \cup \mathcal{A}$ preserves $\mathcal{J}.c_0$ and preserves \mathcal{A} : the statement (1) is proved.

7. Let us show that if the action of \mathcal{B}_{12} on $\text{Curv}(\Sigma)$ preserves \mathcal{A} , then ρ is cyclic.

Since we assume that the action of \mathcal{B}_{12} on $\text{Curv}(\Sigma)$ preserves the curve simplex \mathcal{A} , we can apply Proposition 7.4 and conclude that \mathcal{B}_{12} acts cyclicly on \mathcal{A} , and so \mathcal{F}_{12} acts trivially on \mathcal{A} . Let us consider the subgroup \mathcal{F}_{12}^* of \mathcal{F}_{12} which is isomorphic to \mathcal{B}_{10} . Then for any surface $S \in \text{Sub}_{\mathcal{A}}(\Sigma)$, the homomorphism ρ restricted to \mathcal{F}_{12}^* induces a homomorphism in $\mathcal{P}\text{Mod}(S)$. Since S is of genus zero and \mathcal{F}_{12}^* is isomorphic to \mathcal{B}_{10} , we can apply Theorem 4.4 and conclude that the restriction of ρ to \mathcal{F}_{12}^* induces in $\mathcal{P}\text{Mod}(S)$ a cyclic homomorphism. Hence the restriction of ρ to \mathcal{F}_{12}^* induces in $\mathcal{P}\text{Mod}(\Sigma_{\mathcal{A}})$ a cyclic homomorphism. Thus the group $\rho(\mathcal{F}_{12}^*)$ included in $\mathcal{P}_{\mathcal{A}}\text{Mod}(\Sigma)$ is sent in $\mathcal{P}\text{Mod}(\Sigma_{\mathcal{A}})$ on an abelian subgroup \widehat{G} . Let us consider the below diagram.

$$\begin{array}{ccc}
 \rho(\mathcal{F}_{12}^*) \subset \mathcal{P}_{\mathcal{A}}\text{Mod}(\Sigma) & \xrightarrow{\text{cut}_{\mathcal{A}}} & \mathcal{P}\text{Mod}(\Sigma_{\mathcal{A}}) \supset \widehat{G} \\
 & \nearrow \text{cut}_{\mathcal{A}} & \uparrow \text{for}_{\partial\Sigma_{\mathcal{A}}} \\
 G \subset \mathcal{P}_{\mathcal{A}}\text{Mod}(\Sigma) & \xleftarrow{\text{rec}_{\mathcal{A}}} & \text{Mod}(\Sigma_{\mathcal{A}}, \partial\Sigma_{\mathcal{A}}) \supset \widetilde{G} = \text{for}_{\partial\Sigma_{\mathcal{A}}}^{-1}(\widehat{G})
 \end{array}$$

Starting from \widehat{G} , we successively define the groups:

- $\widetilde{G} = \text{for}_{\partial\Sigma_{\mathcal{A}}}^{-1}(\widehat{G})$ where $\text{for}_{\partial\Sigma_{\mathcal{A}}} : \text{Mod}(\Sigma_{\mathcal{A}}, \partial\Sigma_{\mathcal{A}}) \rightarrow \mathcal{P}\text{Mod}(\Sigma_{\mathcal{A}})$ is the canonical “forget” homomorphism. According to Lemma 3.7, \widetilde{G} is abelian,
- $G = \text{rec}_{\mathcal{A}}(\widetilde{G})$ where $\text{rec}_{\mathcal{A}} : \text{Mod}(\Sigma_{\mathcal{A}}, \partial\Sigma) \rightarrow \mathcal{P}_{\mathcal{A}}\text{Mod}(\Sigma)$ is the gluing homomorphism along the curves of \mathcal{A} . The group G is abelian since \widetilde{G} is.

By construction, $\rho(\mathcal{F}_{12}^*)$ is included in G , an abelian group, so $\rho(\mathcal{F}_{12}^*)$ is abelian. Since \mathcal{F}_{12}^* is isomorphic to \mathcal{B}_{10} and since the abelianization of \mathcal{B}_{10} is cyclic, it follows that $\rho(\mathcal{F}_{12}^*)$ is cyclic. So the mapping class $\rho(\tau_3\tau_4^{-1}) = \rho(\tau_3\tau_1^{-1})(\rho(\tau_4\tau_1^{-1}))^{-1}$ coincides with the identity. Hence $\rho(\tau_3) = \rho(\tau_4)$, so according to Lemma 3.1, the homomorphism ρ is cyclic.

8. *Let us show that if $\rho(\mathcal{B}_{12})$ does not preserve \mathcal{A} , then, again, ρ is cyclic.*

If $\rho(\mathcal{B}_{12})$ does not preserve \mathcal{A} , it is clear that there exists a curve $a' \in \mathcal{A}$ and a mapping class $F \in \mathcal{G}_0$ such that $F(a')$ does not belong to \mathcal{A} . Even if it means conjugating F by a power of D , we can assume without loss of generality that $a' = a_0$. For all $i \in \{0\} \cup \{2, 3, \dots, 10\}$, the mapping class A_i commutes with A_0 , hence preserves $\sigma(A_0)$, hence sends a_0 in $\sigma(\mathcal{G}_0)$. But, according to step 5., $\sigma(\mathcal{G}_0)$ is included in $\mathcal{A} \cup \sigma(D)$, that is to say that $\sigma(\mathcal{G}_0)$ is included in \mathcal{A} if $\sigma(D) \setminus \mathcal{A} = \emptyset$, or in $\mathcal{A} \cup \mathcal{J}.c_0$ if $\sigma(D) \setminus \mathcal{A} \neq \emptyset$. If $\sigma(D) \setminus \mathcal{A} \neq \emptyset$, then $\mathcal{J}.c_0$ is stable by $\rho(\mathcal{B}_{12})$ according to step 6., so A_i cannot send a_0 in $\mathcal{J}.c_0$. Hence in all the cases, A_i sends a_0 in \mathcal{A} . But we have seen that $F(a_0)$ did not belong to \mathcal{A} , so F must belong to $\{A_1, A_{11}\}$. Even if it means conjugating F by $A_{11}(A_0A_{11})(A_1A_0A_{11})$, we can assume without loss of generality that $F = A_1$. Let us sum up: we have shown that

$$\text{if } \rho(\mathcal{B}_{12}) \text{ does not preserve } \mathcal{A}, \text{ then } A_1(a_0) \text{ does not belong to } \mathcal{A}. \quad (2)$$

This implies that

$$\text{sp}(a_0) \subset \{A_0, A_2\}, \quad (3)$$

for otherwise, it would exist $j \in \{3, 4, \dots, 11\}$ such that $a_0 \in \sigma(A_j)$ and as we have just seen it, we would deduce that $A_1(a_0)$ would belong to \mathcal{A} , which would contradict (2). Remember that by definition of a_0 , A_0 belongs to $\text{sp}(a_0)$. Hence (3) implies that $\text{sp}(a_0) \in \{\{A_0\}, \{A_0, A_2\}\}$, whence by conjugation,

$$\text{or } \left. \begin{array}{l} \text{for all } i \in \{0, 1, \dots, n-1\}, \text{ we have } \text{sp}(a_i) = \{A_i\} \\ \text{for all } i \in \{0, 1, \dots, n-1\}, \text{ we have } \text{sp}(a_i) = \{A_i, A_{i+2}\}. \end{array} \right\} \quad (4)$$

For all $\ell \in \{4, 5, \dots, 11\}$ and all $\varepsilon \in \{1, 2\}$, A_ε and A_ℓ commute, so $A_\varepsilon(a_\ell)$ belongs to $\sigma(A_\ell)$, which is itself included in $\sigma(\mathcal{G}_0)$. According to step 5., $\sigma(\mathcal{G}_0)$ is included in $\mathcal{A} \cup \sigma(D)$, so $A_\varepsilon(a_\ell)$ belongs to \mathcal{A} or possibly to $\mathcal{J}.c_0$ if $\sigma(D) \setminus \mathcal{A} \neq \emptyset$. But we have seen that $\mathcal{J}.c_0$ (if it exists) is stable by the action of \mathcal{B}_{12} according to step 6., hence $A_\varepsilon(a_\ell)$ belongs to \mathcal{A} . Let us show that $A_\varepsilon(a_\ell) = a_\ell$. We argue differently, depending on the two cases mentioned by (4).

- If $\text{sp}(a_\ell) = \{A_\ell\}$, then the spectrum of each curve of \mathcal{A} is reduced to a singleton, and the canonical reduction system of each mapping class of \mathcal{G}_0 contains only one element of \mathcal{A} . Since $A_\varepsilon(a_\ell) \in \mathcal{A} \cap \sigma(A_\ell)$, it follows that $A_\varepsilon(a_\ell) = a_\ell$.
- If $\text{sp}(a_\ell) = \{A_\ell, A_{\ell+2}\}$, then a_ℓ and $a_{\ell-2}$ are the only curves of \mathcal{A} in $\sigma(A_\ell)$. Hence $A_\varepsilon(a_\ell) = a_\ell$ or $A_\varepsilon(a_\ell) = a_{\ell-2}$. If $A_\varepsilon(a_\ell) = a_{\ell-2}$, we would have $\text{sp}(A_\varepsilon(a_\ell)) = \{A_{\ell-2}, A_\ell\}$. But A_ε commutes with at least one of the two mapping classes $A_{\ell-2}$ or $A_{\ell+2}$. If A_ε commutes with $A_{\ell-2}$, the fact that $A_{\ell-2} \notin \text{sp}(a_\ell)$ implies that $A_{\ell-2} \notin \text{sp}(A_\varepsilon(a_\ell))$; whereas if A_ε commutes with $A_{\ell+2}$, the fact that $A_{\ell+2} \in \text{sp}(a_\ell)$ implies that $A_{\ell+2} \in \text{sp}(A_\varepsilon(a_\ell))$. In the two cases, the fact that $\text{sp}(A_\varepsilon(a_\ell)) = \{A_{\ell-2}, A_\ell\}$ is contradicted, so $A_\varepsilon(a_\ell) \neq a_{\ell-2}$, so $A_\varepsilon(a_\ell) = a_\ell$.

Hence A_ε preserves each curve a_ℓ , $4 \leq \ell \leq 11$. Let us set

$$\mathcal{A}' = \{a_\ell, 4 \leq \ell \leq 11\}.$$

Let us consider the surface $\Sigma_{\mathcal{A}'}$ Figure 17. Since A_ε preserves each curve of \mathcal{A}' , A_ε cannot permute the connected components of $\Sigma_{\mathcal{A}'}$. Hence A_ε (recall that ε ranges over $\{1, 2\}$) induces a mapping class \tilde{A}_ε in $\mathcal{P}\text{Mod}(\Sigma_{\mathcal{A}'})$. But we have the following canonical isomorphism:

$$\mathcal{P}\text{Mod}(\Sigma_{\mathcal{A}'}) = \prod_{S \in \text{Comp}(\Sigma_{\mathcal{A}'})} \mathcal{P}\text{Mod}(S),$$

where $\text{Comp}(\Sigma_{\sigma(\mathcal{G}_0)})$ denotes the set of all connected components of $\Sigma_{\sigma(\mathcal{G}_0)}$. In other words, $\mathcal{P}\text{Mod}(\Sigma_{\mathcal{A}'})$ is a direct product of mapping class groups of surfaces of genus zero (cf. Figure 17). For any connected component S of $\Sigma_{\mathcal{A}'}$, the images of \tilde{A}_1 and \tilde{A}_2 induced in $\mathcal{P}\text{Mod}(S)$

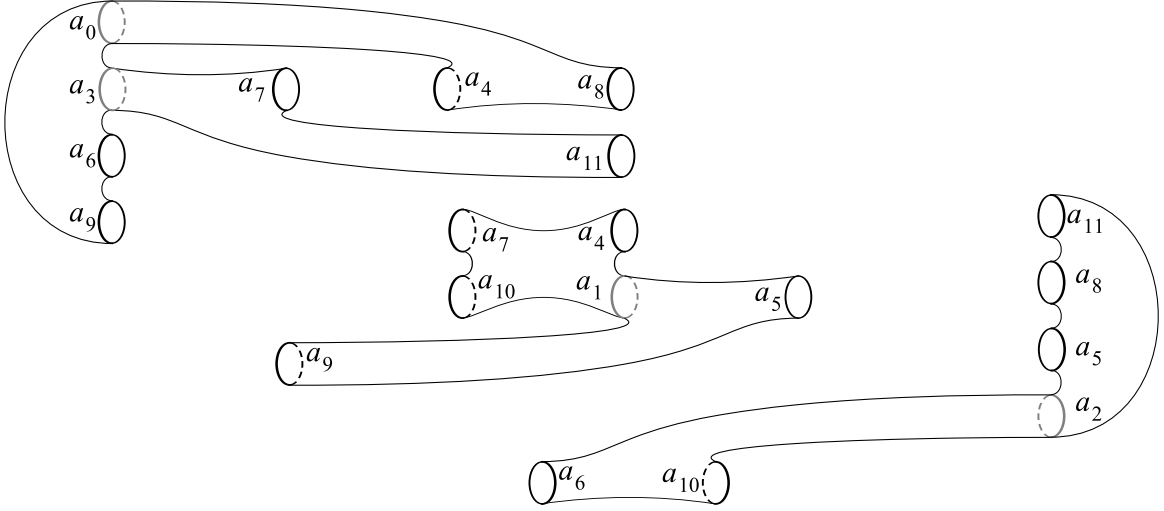

Figure 17: The surface $\Sigma_{\mathcal{A}'}$ is a disjoint union of genus-0 surfaces.

satisfy a braid relation. But S is of genus zero, so we can apply Theorem 4.4. Hence $\tilde{A}_1 = \tilde{A}_2$. Finally, A_1 and A_2 induce the same mapping class in $\mathcal{P}\text{Mod}(\Sigma_{\mathcal{A}'})$, so according to the following central exact sequence:

$$1 \rightarrow \langle T_{a_i}, 0 \leq i \leq n-1 \rangle \rightarrow \mathcal{P}\text{Mod}_{\mathcal{A}'}(\Sigma) \rightarrow \mathcal{P}\text{Mod}(\Sigma_{\mathcal{A}'}) \rightarrow 1,$$

the mapping classes A_1 and A_2 differ from a multitwist that is central in $\mathcal{P}\text{Mod}_{\mathcal{A}'}(\Sigma)$, so A_1 and A_2 commute in Σ . But A_1 and A_2 satisfy also a braid relation, so A_1 and A_2 have to be equal. In other words, ρ is cyclic. \square

Corollary 7.10. *Let n be an integer greater than or equal to 6, Σ a surface $\Sigma_{g,b}$ where $g \leq \frac{n}{2}$ and ρ a noncyclic homomorphism from \mathcal{B}_n to $\mathcal{P}\text{Mod}(\Sigma)$. Then, any curve simplex on which a subgroup of \mathcal{J} acts transitively contains strictly less than $2g$ curves.*

Proof. According to Lemma 7.8, such a simplex \mathcal{A} contains strictly less than $2g$ curves, except if $g = 6$ and $b = 0$ where \mathcal{A} can contain 12 curves. But according to Lemma 7.9, the fact that ρ is not cyclic forbids that \mathcal{A} contains 12 curves. This proves the corollary. \square

We can now prove Proposition 7.11. Let us recall that $n \geq 6$, $\Sigma = \Sigma_{g,b}$ where g and b are some integers such that $g \leq n/2$, and ρ is a noncyclic homomorphism from \mathcal{B}_n to $\mathcal{P}\text{Mod}(\Sigma)$.

Proposition 7.11. *Let a be a curve of $\sigma(\mathcal{G}_0)$. Then $\mathcal{J}.a$ contains at most n curves. The limit case $|\mathcal{J}.a| = n$ takes place if and only if $\mathcal{J}.a$ is not a simplex.*

Proof. Let a be a curve of $\sigma(\mathcal{G}_0)$. If the orbit $\mathcal{J}.a$ is a curve simplex, Corollary 7.10 can be applied: $\mathcal{J}.a$ contains strictly less than $2g$ curves, hence strictly less than n curves.

If $\mathcal{J}.a$ is not a simplex, let us show that $|\mathcal{J}.a| \leq n$. We can assume without loss of generality that $a \in \sigma(A_0)$, in other words, $\text{sp}(a) \supset \{A_0\}$. For all $k \in \{0\} \cup \{2, 3, \dots, n-2\}$, the mapping classes A_0 and A_k commute, so according to Proposition ??.(iii), $I(\sigma(A_0), \sigma(A_k)) = 0$, so $I(a, \delta^k.a) = 0$. But $\mathcal{J}.a$ is not a simplex. Hence a intersects one of the curves of $\mathcal{J}.a$ that belongs necessarily to $\sigma(A_{n-1})$ or to $\sigma(A_1)$. These two cases are symmetric and we can assume without loss of generality that $I(a, \sigma(A_1)) \neq 0$. Then, since A_0 and A_2 are the only mapping classes that do not commute with A_1 , and since $I(a, \sigma(A_1)) \neq 0$, we deduce that $\text{sp}(a) \subset \{A_0, A_2\}$. Let k be the least positive integer such that $\delta^k.a = a$. The integer k satisfies $\delta^k.\text{sp}(a) = \text{sp}(a)$, but since $\text{sp}(a) \subset \{A_0, A_2\}$, then k must be a multiple of n . Let p be the integer $\frac{k}{n}$, so that $|\mathcal{J}.a| = pn$.

Let us denote by $\mathcal{K} = \langle \delta^2 \rangle$. Since $|\mathcal{J}.a| = pn$, we have $|\mathcal{K}.a| = p\frac{n}{2} \geq pg$. But the set $\mathcal{K}.A_0 = \{A_0, A_2, A_4, \dots, A_{n-2}\}$ consists on elements that commute, so $\sigma(\mathcal{K}.A_0)$ is a simplex. Hence $\mathcal{K}.a$, that is included in $\sigma(\mathcal{K}.A_0)$, is a simplex, too. In other words, $\mathcal{K}.a$ is a curve simplex on which \mathcal{K} , a subgroup of \mathcal{J} , acts transitively. Hence according to Corollary 7.10, $|\mathcal{K}.a| < 2g \leq n$. Hence $p = 1$ and $|\mathcal{J}.a| = n$. \square

7.3 Partition of $\sigma(\mathcal{G}_0)$: $\sigma(\mathcal{G}_0) = \sigma_s(\mathcal{G}_0) \sqcup \sigma_n(\mathcal{G}_0)$

Proposition 7.12 (Partition of $\sigma(\mathcal{G}_0)$).

Any curve a belonging to $\sigma(\mathcal{G}_0)$ satisfies either all the left-hand side properties (1g) - (6g), or all the right-hand side properties (1d) - (6d).

(1g)	$I(a, \delta.a) = 0$;	$I(a, \delta.a) \neq 0$	(1d)
(2g)	$ \text{sp}(a) \geq 2$;	$ \text{sp}(a) = 1$	(2d)
(3g)	$I(a, \sigma(\mathcal{G}_0)) = 0$;	$I(a, \sigma(\mathcal{G}_0)) \neq 0$	(3d)
(4g)	$\forall k, \text{sp}(a) \not\subset \{A_k, A_{k+2}\}$;	$\exists k \mid \text{sp}(a) \subset \{A_k, A_{k+2}\}$	(4d)
(5g)	$ \mathcal{J}.a < n$;	$ \mathcal{J}.a = n$	(5d)
(6g)	$\mathcal{J}.a$ is a simplex	;	$\mathcal{J}.a$ is not a simplex	(6d)

Notice that each of the six lines of this table contains two opposite assertions (knowing that $|\mathcal{J}.a| \leq n$, as seen in Proposition 7.11), so that any curve a satisfies exactly one assertion per line. We are going to show that all the right-hand side assertions are equivalent (and so all the left-hand side assertions are equivalent).

Proof.

- Let us first show the cycle of implications (1d) \Rightarrow (3d) \Rightarrow (4d) \Rightarrow (5d) \Rightarrow (6d) \Rightarrow (1d).

(1d) \Rightarrow (3d). This first implication is trivial.

(3d) \Rightarrow (4d). Since $I(a, \sigma(\mathcal{G}_0)) \neq 0$, there exists an integer k such that $I(a, \sigma(A_{k+1})) \neq 0$. But for all $i \in \{0, \dots, n-1\} \setminus \{k, k+2\}$, the mapping classes A_{k+1} and A_i commute, so according to Proposition ??.(iii), $I(\sigma(A_1), \sigma(A_i)) = 0$. Hence $a \notin \sigma(A_i)$. Thus $\text{sp}(a) \subset \{A_k, A_{k+2}\}$.

(4d) \Rightarrow (5d) Let us assume for example that there exists an integer k such that $\text{sp}(\delta^k.a) = \{A_0, A_2\}$ (the situation is even more simple if $\text{sp}(\delta^k.a)$ is a singleton). Then for all integers i , we have $\text{sp}(\delta^{k+i}.a) = \{A_i, A_{i+2}\}$. But $\delta^i.a = a$ only if $\text{sp}(\delta^{k+i}.a) = \text{sp}(\delta^k.a)$, hence only if i is a multiple of n . So $|\mathcal{J}.a| \geq n$. So, according to Proposition 7.11, $|\mathcal{J}.a| = n$.

(5d) \Rightarrow (6d) This is the second part of Proposition 7.11.

(6d) \Rightarrow (1d) Let us start from a curve $a \in \sigma(\mathcal{G}_0)$, and let us denote by \mathcal{A} its orbit $\mathcal{J}.a$. We have:

$$\begin{aligned} I(\mathcal{A}, \mathcal{A}) &= \sum_{0 \leq i, j \leq n-1} I(\delta^i.a, \delta^j.a) \\ &= \sum_{\substack{0 \leq i \leq n-1 \\ j \in \{i-1, i+1\}}} I(\delta^i.a, \delta^j.a) \\ &= n I(a, \delta.a) + n I(a, \delta^{-1}.a) \\ &= 2n I(a, \delta.a). \end{aligned}$$

Hence if \mathcal{A} is not a simplex, in other words if $I(\mathcal{A}, \mathcal{A}) \neq 0$, then $I(a, \delta.a) \neq 0$.

- We terminate the proof of Proposition 7.12 by showing the implications (1d) \Rightarrow (2d) \Rightarrow (4d).

(1d) \Rightarrow (2d) If $I(a, \delta.a) \neq 0$, then the action of δ^{-1} on the pair $(a, \delta.a)$ implies that $I(\delta^{-1}.a, a) \neq 0$. Let i be an integer in $\{0, 1, \dots, n-1\}$ such that $a \in \sigma(A_i)$. Then we have $\delta.a \in \sigma(A_{i+1})$ and $\delta^{-1}.a \in \sigma(A_{i-1})$. Hence according to Proposition ??.(iii), the inequality $I(a, \delta.a) \neq 0$ implies the inclusion $\text{sp}(a) \subset \{A_i, A_{i+2}\}$ and similarly, the inequality $I(\delta^{-1}.a, a) \neq 0$ implies the inclusion $\text{sp}(a) \subset \{A_{i-2}, A_i\}$. Finally, we have $\text{sp}(a) = \{A_i\}$.

(2d) \Rightarrow (4d) This last implication is trivial. \square

Fundamental remark. Recall that we have defined the special curves as being the curves $a \in \sigma(\mathcal{G}_0)$ satisfying $I(a, \sigma(\mathcal{G}_0)) \neq 0$, and the normal curves as being the curves $a \in \sigma(\mathcal{G}_0)$ satisfying $I(a, \sigma(\mathcal{G}_0)) = 0$. In other words, the special curves are those satisfying the right-and side assertions of Proposition 7.12 and the normal curves are those satisfying the left-hand side assertions of Proposition 7.12.

7.4 Stability and existence results

This subsection is devoted to Propositions 7.13, and 7.14 concerning the stability of the normal and the special curves, and to Propositions 7.16 and 7.17 concerning the existence of special curves, all being crucial, and more especially Proposition 7.16.

Proposition 7.13 (Stability of the special curves).

(i) The set $\sigma_s(\mathcal{G}_0)$ is \mathcal{J} -stable.

(ii) For any $i \leq n-1$, the set $\sigma_s(A_i)$ is stable by all the elements of $\mathcal{G}_0 \setminus \{A_{i-1}, A_{i+1}\}$.

Proof.

Let us show item (i).

For all $a \in \sigma_s(\mathcal{G}_0)$, we have $I(a, \delta.a) \neq 0$. From the point of view of the curve $\delta.a$, we have $I(\delta.a, \sigma(\mathcal{G}_0)) \neq 0$. As \mathcal{G}_0 is stable by the action of δ via ρ by conjugation on $\mathcal{PMod}(\Sigma)$, the curve $\delta.a$ belongs to $\sigma(\mathcal{G}_0)$. Finally, $\delta.a$ belongs to $\sigma_s(\mathcal{G}_0)$. Hence $\sigma_s(\mathcal{G}_0)$ is \mathcal{J} -stable.

Let us show item (ii).

To simplify the proof, we set $i = 0$. Let a be a special curve of $\sigma_s(A_0)$. Let j be an integer in $\{3, \dots, n-2\}$ so that A_j commutes with A_0 and A_1 . Then $A_j(a) \in \sigma(A_0)$ and $A_j(\delta.a) \in \sigma(A_1)$. By hypothesis, a is special, so $I(a, \delta.a) \neq 0$. Then, when we apply A_j to the pair $(a, \delta.a)$, we get $I(A_j(a), \sigma(A_1)) \neq 0$, so $A_j(a) \in \sigma_s(A_0)$.

Symmetrically, when $j = 2$, if we replace $\delta.a$ by $\delta^{-1}.a$, we show that $I(A_2(a), \sigma(A_{n-1})) \neq 0$, so $A_2(a) \in \sigma_s(A_0)$.

We have one more case to deal with, when $j = 0$. Let us start again from $a \in \sigma_s(A_0)$. Then $A_0(a) \in \sigma(A_0)$. We want to show that $A_0(a)$ is a special curve. We are going to show that $|\mathcal{J}.(A_0(a))| = n$, which is enough according to Proposition 7.12. Since a is special, we have $\text{sp}(a) = \{A_0\}$. Now, for all $\ell \in \{2, \dots, n-2\}$, the mapping class A_ℓ commutes with A_0 and $a \notin \sigma(A_\ell)$, so $A_0(a) \notin \sigma(A_\ell)$. Hence we have:

$$\{A_0\} \subset \text{sp}(A_0(a)) \subset \{A_{n-1}, A_0, A_1\}.$$

So for all integers k , $\delta^k.\text{sp}(A_0(a)) = \text{sp}(A_0(a))$ if and only if k is a multiple of n . So, if $\delta^k.A_0(a) = A_0(a)$ then k is a multiple of n , so $|\mathcal{J}.(A_0(a))| \geq n$. Hence according to Proposition 7.11, we have $|\mathcal{J}.(A_0(a))| = n$. So $A_0(a)$ is a special curve. \square

Proposition 7.14 (Stability of the normal curves).

The set $\sigma_n(\mathcal{G}_0)$ is \mathcal{B}_n -stable and the actions of \mathcal{B}_n via ρ on $\sigma_n(\mathcal{G}_0)$, on $\text{Sub}_{\sigma_n(\mathcal{G}_0)}(\Sigma)$ and on $\text{Bndy}(\Sigma_{\sigma_n(\mathcal{G}_0)})$ are cyclic.

Proof. Let us recall that according to Proposition 7.12, $\sigma_n(\mathcal{G}_0)$ is a simplex. Then if we show that $\sigma_n(\mathcal{G}_0)$ is \mathcal{B}_n -stable, we can apply Proposition 7.4 (according to which any action of \mathcal{B}_n on a curve simplex \mathcal{B}_n -stable is cyclic) and deduce from it Proposition 7.14. Let a be a normal curve. We proceed as follows:

1. We show that $A_1(a)$ belongs to $\sigma(\mathcal{G}_0)$.
2. We show that $A_1(a)$ is not special, hence is normal.
3. Therefore $\sigma(\mathcal{G}_0)$ is \mathcal{B}_n -stable.

1. Let a be a normal curve. According to assertion (2g) of Proposition 7.12, $\text{sp}(a)$ contains at least two elements A_i and A_j with $0 \leq i < j \leq n-1$, and according to assertion (4g) of the same proposition, we can assume that $j \notin \{i+2, i+n-2\}$. In particular $\{i, j\} \neq \{0, 2\}$. Therefore A_1 commutes with at least one of the two mapping classes A_i and A_j , so $A_1(a) \in \sigma(\mathcal{G}_0)$.

2. Let us assume that $A_1(a)$ is special. If $A_1(a)$ did not belong to $\sigma_s(A_0)$ or to $\sigma_s(A_2)$, then according to Proposition 7.13.(ii), $A_1^{-1}(A_1(a))$ would still be a special curve. But $A_1^{-1}(A_1(a)) = a$, which is a normal curve. Therefore $A_1(a)$ belongs to $\sigma_s(A_0)$ or $\sigma_s(A_2)$. The situation being symmetric, we can assume that

$$A_1(a) \in \sigma_s(A_0). \tag{1}$$

Having assumed that $A_1(a)$ was special, we have $I(A_1(a), \delta.A_1(a)) \neq 0$, so

$$I(a, A_1^{-1}(\delta.A_1(a))) \neq 0. \tag{2}$$

Now, according to (1), $A_1(a) \in \sigma(A_0)$, so $\delta.A_1(a) \in \sigma(A_1)$ and $A_1^{-1}(\delta.A_1(a)) \in \sigma(A_1)$. Then (2) implies:

$$I(a, \sigma(\mathcal{G}_0)) \neq 0,$$

which is absurd since a is a normal curve.

3. Let us conclude: we have just shown that $A_1(\sigma_n(\mathcal{G}_0)) = \sigma_n(\mathcal{G}_0)$. But $\sigma_n(\mathcal{G}_0) = \sigma(\mathcal{G}_0) \setminus \sigma_s(\mathcal{G}_0)$ and the two sets $\sigma(\mathcal{G}_0)$ and $\sigma_s(\mathcal{G}_0)$ are \mathcal{J} -stable (for $\sigma_s(\mathcal{G}_0)$, this comes from Proposition 7.13), so $\sigma_n(\mathcal{G}_0)$ is \mathcal{J} -stable. Hence for all integers $i \in \{1, \dots, n-1\}$, we have $(\rho(\delta^i)A_1\rho(\delta^i)^{-1})(\sigma_n(\mathcal{G}_0)) = \sigma_n(\mathcal{G}_0)$, in other words, $A_i(\sigma_n(\mathcal{G}_0)) = \sigma_n(\mathcal{G}_0)$. Since \mathcal{G}_0 spans $\rho(\mathcal{B}_n)$, it follows that $\sigma_n(\mathcal{G}_0)$ is stable by $\rho(\mathcal{B}_n)$. \square

Proposition 7.15 (Spectrum of the normal curves).

The spectrum of a normal curve is always equal to \mathcal{G}_0 .

Proof. Let a be a normal curve. There exists an integer k such that the curve $a' = \rho(\delta^k)(a)$ belongs to $\sigma(A_0)$. Then the curve $(A_0A_1A_0A_3^{-3})(a')$ belongs to $\sigma(A_1)$ for

$$(A_0A_1A_0A_3^{-3})A_0(A_0A_1A_0A_3^{-3})^{-1} = A_1.$$

But since the action of \mathcal{B}_n is cyclic on the normal curves according to Proposition 7.14, the action of $(A_0A_1A_0A_3^{-3})$ is trivial and $(A_0A_1A_0A_3^{-3})(a') = a'$, so the curve a' belongs to $\sigma(A_1)$. For all $i \in \{0, 1, \dots, n-1\}$, the same argument can be repeated, so a' belongs to $\sigma(A_i)$ for all $i \in \{0, 1, \dots, n-1\}$. By conjugating this by $\rho(\delta^{-k})$, it follows that the curve $a = \rho(\delta^{-k})(a')$ belongs to $\sigma(A_i)$ for all $i \in \{0, 1, \dots, n-1\}$. The proposition is proved. \square

Proposition 7.16 (Existence of the special curves). *The set $\sigma_s(\mathcal{G}_0)$ is not empty.*

Proof. Let us recall that the homomorphism ρ is assumed to be noncyclic. We argue by contradiction: we assume that all the curves of $\sigma(\mathcal{G}_0)$ are normal.

First, since ρ is not cyclic and according to Theorem 5.1, $\sigma(\mathcal{G}_0)$ is not empty. Then the set $\sigma(\mathcal{G}_0)$ of curves (being all normal by assumption) is a simplex, according to Proposition 7.12. Moreover, this simplex is \mathcal{B}_n -stable according to Proposition 7.14. The Proposition 7.4 can be applied to the simplex $\sigma(\mathcal{G}_0)$, so the action of \mathcal{B}_n on $\text{Bndy}(\Sigma_{\sigma(\mathcal{G}_0)})$ is cyclic and the one of \mathcal{F}_n on $\text{Bndy}(\Sigma_{\sigma(\mathcal{G}_0)})$ is trivial. Hence the homomorphism ρ induces a homomorphism $\bar{\rho}$ from \mathcal{F}_n to $\mathcal{PMod}(\Sigma_{\sigma(\mathcal{G}_0)})$. Recall that we have the following canonical isomorphism:

$$\mathcal{PMod}(\Sigma_{\sigma(\mathcal{G}_0)}) = \prod_{S \in \text{Comp}(\Sigma_{\sigma(\mathcal{G}_0)})} \mathcal{PMod}(S),$$

where $\text{Comp}(\Sigma_{\sigma(\mathcal{G}_0)})$ denotes the set of all connected components of $\Sigma_{\sigma(\mathcal{G}_0)}$. Let S be one of these components and let $\bar{\rho}_S$ be the homomorphism induced by ρ on $\mathcal{PMod}(S)$. The homomorphism $\bar{\rho}_S$ is irreducible, that is, for all $i \in \{3, \dots, n-1\}$, the element $\tau_i\tau_1^{-1}$ is sent on a irreducible mapping class. Indeed, according to Proposition ??.(v), $\sigma(\rho(\tau_i\tau_1^{-1})) \subset \sigma(\rho(\tau_i)) \cup \sigma(\rho(\tau_1^{-1}))$, but these two sets $\sigma(\rho(\tau_i))$ and $\sigma(\rho(\tau_1^{-1}))$ do not contain any curve in S , so $\sigma(\bar{\rho}_S(\tau_i\tau_1^{-1})) = \emptyset$. We will say that $\bar{\rho}_S$ is *periodic* or *pseudo-Anosov* whether $\bar{\rho}_S(\tau_3\tau_1^{-1})$ is periodic or pseudo-Anosov. Let us denote by $A = \bar{\rho}_S(\tau_3\tau_1^{-1})$, $B = \bar{\rho}_S(\tau_4\tau_1^{-1})$, $C = \bar{\rho}_S(\tau_5\tau_1^{-1})$, and $Z = ABACBA$.

Case where $\bar{\rho}_S$ is pseudo-Anosov¹: According to Proposition ??.(iv), the centralizer of a pseudo-Anosov mapping class is virtually infinite cyclic. Then, since C is in the centralizer of

¹We cannot apply the results of Section 5 for \mathcal{F}_n^* can be isomorphic to \mathcal{B}_4 and this case is not treated in Section 5. On the other hand, the techniques involved here would have appeared quite complicated in Section 5 when the boundary of Σ is nonempty, and simply do not work when the boundary is empty.

A , there exist two nonzero integers p and q such that $A^p = C^q$. By conjugating this equality by Z , we get $C^p = A^q$. Hence $A^{p^2} = C^{qp} = A^{q^2}$. We deduce that $p = q$ or $p = -q$. We are going to show that both of these two equalities are absurd. For this purpose, we set $\gamma_{13} = \tau_1\tau_2\tau_1\tau_3\tau_2\tau_1$ and $\gamma_{35} = \tau_3\tau_4\tau_3\tau_5\tau_4\tau_3$. Notice that:

$$\begin{aligned}\gamma_{13} \tau_1 \gamma_{13}^{-1} &= \tau_3 \text{ and } \gamma_{35} \tau_1 \gamma_{35}^{-1} = \tau_1, \\ \gamma_{13} \tau_3 \gamma_{13}^{-1} &= \tau_1 \text{ and } \gamma_{35} \tau_3 \gamma_{35}^{-1} = \tau_5, \\ \gamma_{13} \tau_5 \gamma_{13}^{-1} &= \tau_5 \text{ and } \gamma_{35} \tau_5 \gamma_{35}^{-1} = \tau_3.\end{aligned}$$

Hence, if we set $v = \gamma_{13}\gamma_{35}^{-1}$, then the element v belongs to \mathcal{F}_n and satisfies:

$$\begin{aligned}v \tau_1 v^{-1} &= \tau_3, & v \tau_3 v^{-1} &= \tau_5, & v \tau_5 v^{-1} &= \tau_1, \\ v (\tau_3\tau_1^{-1}) v^{-1} &= \tau_5\tau_3^{-1}, & v (\tau_5\tau_3^{-1}) v^{-1} &= \tau_1\tau_5^{-1}, & v (\tau_1\tau_5^{-1}) v^{-1} &= \tau_3\tau_1^{-1}.\end{aligned}$$

Then if we set $U = \rho_S(v)$, then:

$$\begin{aligned}\text{we have:} & \quad UAU^{-1} = CA^{-1}, \quad U(CA^{-1})U^{-1} = C^{-1}, \quad UC^{-1}U^{-1} = A, \\ \text{so if } C^p = A^p: & \quad U A^p U^{-1} = \text{Id}, \quad U(\text{Id})U^{-1} = A^{-p}, \quad U A^{-p} U^{-1} = A^p, \\ \text{and if } C^p = A^{-p}: & \quad U A^p U^{-1} = A^{-2p}, \quad U(A^{-2p})U^{-1} = A^p, \quad U A^p U^{-1} = A^p.\end{aligned}$$

So if $C^p = A^p$, then A^p is equal to Id , which is absurd for A is pseudo-Anosov; whereas if $C^p = A^{-p}$, then we have $U A^p U^{-1} = A^p$ and $U A^p U^{-1} = A^{-2p}$ whence $A^p = A^{-2p}$ and so $A^{3p} = \text{Id}$, which is also absurd. Hence ρ_S is not pseudo-Anosov.

Case where $\bar{\rho}_S$ is periodic. Notice that the mapping classes A, B, C are conjugate. There are then periodic of same order. Let us call m this order. We restrict the domain of the homomorphism $\bar{\rho}_S$ to \mathcal{F}_n^* , which is isomorphic to \mathcal{B}_{n-2} . According to Proposition 3.8, we can lift this new homomorphism from \mathcal{F}_n^* to $\mathcal{PMod}(S)$ into a homomorphism $\tilde{\rho}_S$ from \mathcal{F}_n^* to $\text{Mod}(S, \partial S)$. Let us denote by $\tilde{A}, \tilde{B}, \tilde{C}$, the images by $\tilde{\rho}_S$ of $\tau_3\tau_1^{-1}, \tau_4\tau_1^{-1}, \tau_5\tau_1^{-1}$. Then \tilde{A}^m and \tilde{C}^m are multitwists along some curves of $\text{Bndy}(S)$. Since these multitwists are in the center of $\text{Mod}(S, \partial S)$ and since $\tilde{Z}\tilde{A}^m\tilde{Z}^{-1} = \tilde{C}^m$ (where $\tilde{Z} = (\tilde{A}\tilde{B}\tilde{C})^2$), we have $\tilde{A}^m = \tilde{C}^m$. Therefore, $\tilde{A}\tilde{C}^{-1}$ satisfies $(\tilde{A}\tilde{C}^{-1})^m = 1$ in $\text{Mod}(S, \partial S)$. But $\text{Mod}(S, \partial S)$ is torsion-free, so $\tilde{A}\tilde{C}^{-1}$ is trivial and $\tilde{A} = \tilde{C}$. This implies that in $\mathcal{PMod}(S)$, we have $\bar{\rho}_S(\tau_3\tau_1^{-1}) = \bar{\rho}_S(\tau_5\tau_1^{-1})$.

This last equality holds for any connected components S of $\Sigma_{\sigma(\mathcal{G}_0)}$. Hence, by considering the homomorphism $\bar{\rho} : \mathcal{F}_n \rightarrow \mathcal{PMod}(\Sigma_{\sigma(\mathcal{G}_0)})$, we have shown that $\bar{\rho}(\tau_3\tau_1^{-1}) = \bar{\rho}(\tau_5\tau_1^{-1})$. Then $\bar{\rho}(\tau_5\tau_3^{-1})$ coincides with the identity of $\mathcal{PMod}(\Sigma_{\sigma(\mathcal{G}_0)})$. Let us recall that \mathcal{B}_n stabilizes $\Sigma_{\sigma(\mathcal{G}_0)}$. Then by conjugation in \mathcal{B}_n , we deduce that the homomorphism $\bar{\rho} : \mathcal{F}_n \rightarrow \mathcal{PMod}(\Sigma_{\sigma(\mathcal{G}_0)})$ is trivial. Hence the image of the restriction of the homomorphism ρ to \mathcal{F}_n^* to $\mathcal{PMod}(\Sigma)$ is included in the abelian group spanned by the Dehn twists along the curves of $\sigma(\mathcal{G}_0)$. Hence, according to Lemma 3.2, the restriction of ρ to \mathcal{F}_n^* is a cyclic homomorphism. Therefore $\rho(\tau_5\tau_3^{-1})$ is the identity, so $\rho(\tau_3) = \rho(\tau_5)$. Hence, according to Lemma 3.1, ρ is a cyclic homomorphism. This is contradicts our hypotheses, so the proposition is proved. \square

Proposition 7.17 (Cardinality of $\sigma_s(\mathcal{G}_0)$).

The set $\sigma_s(\mathcal{G}_0)$ contains n or $2n$ curves, depending on whether $|\sigma_s(A_1)| = 1$ or $|\sigma_s(A_1)| = 2$.

Proof. First, according to Proposition 7.13, we have $\delta.\sigma_s(A_i) = \sigma_s(A_{i+1})$, so the cardinality of $\sigma_s(\mathcal{G}_0)$ is equal to n times the one of $\sigma_s(A_1)$. But $\sigma_s(A_1)$ contains one or two curves for on one hand, it cannot be empty since $\sigma_s(\mathcal{G}_0)$ is not empty, and on the other hand, it cannot contain three curves or more as we are going to show it. This prove the proposition.

Let us then show that $|\sigma_s(A_1)| < 3$. Notice that the elements $A_1, A_3, A_5, \dots, A_{n-1}$ pairwise commute, so the set of curves $\sigma_s(A_1) \cup \sigma_s(A_3) \cup \dots \cup \sigma_s(A_{n-1})$ is a simplex. If $\sigma_s(A_1)$ contained

at least three curves, the set of curves $\sigma_s(A_1) \cup \sigma_s(A_3) \cup \cdots \cup \sigma_s(A_{n-1})$ would be a simplex \mathcal{A} of at least $\frac{3n}{2}$ curves that would be stable by the action of $\langle \delta^2 \rangle$ on $\mathcal{C}urv(\Sigma)$. However, the orbits included in \mathcal{A} under the action of $\langle \delta^2 \rangle$ contain at least $\frac{n}{2}$ curves, which is greater than or equal to 3, so we can apply Proposition 4.9: after having squeezed the boundary components of Σ , the simplex \mathcal{A} still contains at least $\frac{3n}{2}$ distinct curves. But $\frac{3n}{2} \geq 3g$ whereas the cardinality of all simplex in a surface without boundary of genus g is bounded by $3g - 3$. This is the expected contradiction. \square

8 The special curves are not separating

Hypotheses.

Let $n \geq 6$ an even number, let $\Sigma = \Sigma_{g,b}$ with $g \leq \frac{n}{2}$, and let $\rho : \mathcal{B}_n \rightarrow \mathcal{P}Mod(\Sigma)$ such that:

- ρ is non-cyclic by assumption,
- $\sigma_p(\mathcal{G}_0) = \emptyset$ by assumption, inspired by Proposition 4.7,
- $\sigma_s(\mathcal{G}_0) \neq \emptyset$ as a consequence of the non-cyclicity of ρ , after Proposition 7.16.

In this section, we are going to show the following proposition:

Proposition 8.1. *The curves of $\sigma_s(\mathcal{G}_0)$ are not separating.*

• In Subsection 8.1, we present a subset \mathcal{X} of \mathcal{G}_0 , stable under the action of \mathcal{H} via ρ , where \mathcal{H} is a subgroup of \mathcal{B}_n . The set \mathcal{X} is smaller than \mathcal{G}_0 , but the action of \mathcal{H} on \mathcal{X} is r times transitive, where r is the cardinality of \mathcal{X} . Moreover, \mathcal{X} will consists in elements of \mathcal{G}_0 which pairwise commute, so the union of their canonical reduction systems will be a simplex. These aspects will be very useful.

• Subsection 8.2 is devoted to the proof of Proposition 8.1. The proof will be topological and the bound of $\frac{n}{2}$ on the genus of Σ is essential here. If we wanted to replace the bound $\frac{n}{2}$ by $\frac{n}{2} + 1$, our method would fail. However, we conjecture that the bound $\frac{n}{2}$ is not the best one.

8.1 The subgroup \mathcal{H} of \mathcal{B}_n and its action on the subset \mathcal{X} of \mathcal{G}_0

The subset $Odd(n)$ of $\{0, 1, \dots, n-1\}$ and the subset \mathcal{X} of \mathcal{G}_0 .

For all positive integers m , let $Odd(m)$ be the set of the first odd integers smaller than or equal to m . Let $\mathcal{X} = \{A_i, i \in Odd(n)\}$ be the subset of \mathcal{G}_0 . We set $\sigma(\mathcal{X}) = \cup_{i \in Odd(n)} \sigma(A_i)$. The elements of \mathcal{X} commute pairwise, so the curves in $\sigma(\mathcal{X})$ cannot intersect each other. Thus $\sigma(\mathcal{X})$ is a curve simplex.

The subgroup \mathcal{H} of \mathcal{B}_n

For all integers i belonging to $Odd(n)$, we set

$$\gamma_i = \tau_i \tau_{i+1} \tau_i \tau_{i+2} \tau_{i+1} \tau_i,$$

where for all integers k , we denote by τ_k the standard generator τ_ℓ where ℓ is the remainder of the euclidian division of k by n . The group \mathcal{H} is the subgroup of \mathcal{B}_n defined by

$$\mathcal{H} := \langle \gamma_i, i \in Odd(n) \rangle.$$

Proposition 8.2 (Properties of the group \mathcal{H}).

- (i) The action of \mathcal{H} by conjugation via ρ on $\mathcal{PMod}(\Sigma)$ preserves \mathcal{X} .
- (ii) The homomorphism $\mathcal{H} \rightarrow \mathfrak{S}(\mathcal{X})$ of the action of \mathcal{H} on \mathcal{X} , where $\mathfrak{S}(\mathcal{X})$ is the symmetric group on the elements of \mathcal{X} , is surjective. Consequently, this action is $\frac{n}{2}$ times transitive.
- (iii) The action of \mathcal{H} on $\mathcal{Curv}(\Sigma)$ preserves $\sigma_s(\mathcal{X})$.

Proof. Let us first remark that for all $i \in \text{Odd}(n)$, the element γ_i acts by conjugation on the subset $\{\tau_j, j \in \text{Odd}(n)\}$ of \mathcal{B}_n in the following way:

$$\gamma_i \tau_j \gamma_i^{-1} = \begin{cases} \tau_j & \text{if } j \notin \{i, i+2\} \\ \tau_{j-2} & \text{if } j = i+2 \\ \tau_{j+2} & \text{if } j = i. \end{cases}$$

We deduce the following:

- (i) The group \mathcal{H} acts by conjugation on \mathcal{B}_n and preserves the set $\{\tau_j, j \in \text{Odd}(n)\}$, so the group \mathcal{H} acts via ρ on $\mathcal{PMod}(\Sigma)$ and preserves \mathcal{X} .
- (ii) For all $i \in \text{Odd}(n)$, the homomorphism $\phi : \mathcal{H} \rightarrow \mathfrak{S}(\mathcal{X})$, where $\mathfrak{S}(\mathcal{X})$ is the symmetric group on the elements of \mathcal{X} , sends γ_i on the transposition that swaps A_i and A_{i+2} . Then $\phi(\mathcal{H})$ is a subgroup of $\mathfrak{S}(\mathcal{X})$ containing $\frac{n}{2} - 1$ transpositions with disjoint supports, so ϕ is surjective.
- (iii) The action of \mathcal{H} on $\mathcal{Curv}(\Sigma)$ preserves $\sigma(\mathcal{X})$, since the action of \mathcal{H} on $\mathcal{PMod}(\Sigma)$ preserves \mathcal{X} . Now, according to Proposition 7.14, the action of \mathcal{B}_n on $\mathcal{Curv}(\Sigma)$ preserves $\sigma_n(\mathcal{G}_0)$, so the action of \mathcal{H} on $\mathcal{Curv}(\Sigma)$ preserves $\sigma_n(\mathcal{G}_0)$. So the action of \mathcal{H} on $\mathcal{Curv}(\Sigma)$ also preserves the complement of $\sigma_n(\mathcal{G}_0)$ in $\sigma(\mathcal{X})$, which is $\sigma_s(\mathcal{X})$. \square

8.2 Proof of Proposition 8.1

We will need the definition of *natural boundary* and *special boundary* of a subsurface.

Natural boundary and special boundary.

Let n be an even integer greater than or equal to 6, let Σ be a surface and ρ a homomorphism from \mathcal{B}_n to $\mathcal{PMod}(\Sigma)$. Let \mathcal{A} be a curve simplex included in $\mathcal{Curv}(\Sigma)$. For any subsurface S of $\text{Sub}_{\mathcal{A}}(\Sigma)$, a boundary component d of S will be said to be *natural* if it belongs to $\text{Bndy}(\Sigma)$, and will be said to be *special* if it belongs to $\sigma_s(\mathcal{G}_0)$. The union of the natural boundary components will be called the natural boundary, and the union of the special boundary components will be called the special boundary.

To prove Proposition 8.1, we proceed in five steps.

Step 1. *If there exists in $\sigma_s(\mathcal{G}_0)$ a separating curve, then for all $i \in \{0, 1, \dots, n-1\}$, the set of curves $\sigma_s(A_i)$ contains exactly a separating curve that bounds a torus with one hole (cf. Figure 18). Thus, Σ is a surface of genus $g = \frac{n}{2}$.*

Proof of step 1. If there exists a separating curve in $\sigma_s(\mathcal{G}_0)$, then there exists at least one separating curve in $\sigma_s(A_1)$. Let us call it a_1 . Let \mathcal{A} be the set of curves $\mathcal{H}.a_1$. Since we have $a_1 \in \sigma(\mathcal{X})$ and since \mathcal{X} is \mathcal{H} -stable, the set \mathcal{A} is included in $\sigma(\mathcal{X})$, hence is a simplex. Let us consider the graph $\Gamma(\Sigma, \mathcal{A})$. Since the curves of \mathcal{A} are separating, if we remove from $\Gamma(\Sigma, \mathcal{A})$ one of its edges, we get a disconnected graph. Hence the graph $\Gamma(\Sigma, \mathcal{A})$ contains no cycle: this

graph is a finite tree. So it contains leaves (vertices of degree 1). Let T be a subsurface of $\text{Sub}_{\mathcal{A}}(\Sigma)$ corresponding to a leaf in $\Gamma(\Sigma, \mathcal{A})$. Since exactly one curve of \mathcal{A} bounds T , T is not stable by the action of \mathcal{H} , so T contains no natural boundary component. Hence T has only one boundary component, so T is of nonzero genus. Each subsurface in the orbit $\mathcal{H}.T$ can be identified by the curve $a \in \mathcal{A}$ that bounds it. Since the number of curves in \mathcal{A} is at least equal to the cardinality of \mathcal{X} , there exists at least $\frac{n}{2}$ disjoint subsurfaces homeomorphic to T in $\text{Sub}_{\mathcal{A}}(\Sigma)$. But Σ is of genus $g \leq \frac{n}{2}$, so:

- there exist exactly $\frac{n}{2}$ such subsurfaces,
- these subsurfaces are tori with one hole,
- and Σ is of genus $g = \frac{n}{2}$.

So, there exist exactly $\frac{n}{2}$ curves in \mathcal{A} , hence one separating curve in each set $\sigma_s(A_i)$, $i \in \text{Odd}(n)$. Moreover, the complement of these $\frac{n}{2}$ tori is a genus-0 surface having $\frac{n}{2}$ special boundary components and b natural boundary components (cf. Figure 18). \square

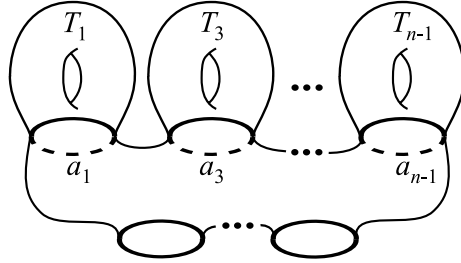

Figure 18: The surface Σ and the separating curves a_i , $i \in \text{Odd}(n)$ of $\sigma(\mathcal{X})$.

From now on, we are in the situation described by step 1 and we adopt the following notation.

Situation described by step 1

For all $i \in \{0, 1, \dots, n-1\}$, let us denote by a_i the unique separating curve of $\sigma_s(A_i)$ and by T_i the torus with one hole, included in Σ and bounded by a_i . Let us denote by S the genus-0 surface obtained from Σ minus the tori T_i where i ranges over $\text{Odd}(n)$ (cf. Figure 18). Let us choose some representatives \bar{a}_i , $i \in \{0, 1, \dots, n-1\}$ in tight position, of the curves a_i , $i \in \{0, 1, \dots, n-1\}$ (such a system of representatives is unique up to isotopy, according to Proposition ??). From these representatives of curves, we deduce the representatives \bar{S} and \bar{T}_i for all $i \in \{0, 1, \dots, n-1\}$, of the subsurfaces S and T_i for all $i \in \{0, 1, \dots, n-1\}$.

Step 2. *There exists an orientation preserving diffeomorphism \bar{F} of Σ that preserves the boundary components of Σ such that*

- for all $i \in \{1, 2, 3\}$, we have $\bar{F}(\bar{a}_i) = \bar{a}_{4-i}$,
- and for all $i \in \{5, 6, \dots, n-1\}$, we have $\bar{F}(\bar{a}_i) = \bar{a}_i$.

Proof of step 2. Let \bar{G} be a diffeomorphism representing the mapping class $\rho(\gamma_1)$ where γ_1 is defined by:

$$\gamma_1 := \tau_1 \tau_2 \tau_1 \tau_3 \tau_2 \tau_1.$$

Let us denote by $\bar{\mathcal{A}}$ the set of representatives of curves $\{\bar{a}_2\} \cup \{\bar{a}_i, i \in \text{Odd}(n)\}$ and $\bar{\mathcal{A}}'$ the set $\{\bar{G}(\bar{a}_2)\} \cup \{\bar{G}(\bar{a}_i), i \in \text{Odd}(n)\}$. According to Proposition 8.2,

- for any $i \in \{1, 2, 3\}$, we have $\rho(\gamma_1)A_i\rho(\gamma_1)^{-1} = A_{4-i}$,
- and for any $i \in \{5, 6, \dots, n-1\}$, we have $\rho(\gamma_1)A_i\rho(\gamma_1)^{-1} = A_i$.

Besides, for any $i \in \{0, 1, \dots, n-1\}$, the curve a_i is the unique separating curve belonging to $\sigma_s(A_i)$, so:

- for any $i \in \{1, 2, 3\}$, the curve $\bar{G}(\bar{a}_i)$ is isotopic to \bar{a}_{4-i} ,
- and for any $i \in \{5, 6, \dots, n-1\}$, the curve $\bar{G}(\bar{a}_i)$ is isotopic to \bar{a}_i .

Then, the sets of curves $\bar{\mathcal{A}}$ and $\bar{\mathcal{A}}'$ are both weakly isotopic. Let us recall that $\bar{\mathcal{A}}$ is a set of representatives of curves in tight position. Hence the representatives of curves of $\bar{\mathcal{A}}$ do not bound any bigon. But $\bar{\mathcal{A}}'$ is the image of $\bar{\mathcal{A}}$ by \bar{G} . So the representatives of curves of $\bar{\mathcal{A}}'$ do not bound any bigon either. Hence $\bar{\mathcal{A}}'$ is a set of representatives of curves in tight position. Moreover $\bar{\mathcal{A}}$ is without triple intersection, hence so is $\bar{\mathcal{A}}'$. Then, according to Proposition ??, $\bar{\mathcal{A}}$ and $\bar{\mathcal{A}}'$ are in the same isotopy class. In other words, there exists a diffeomorphism isotopic to the identity \bar{H} such that $\bar{H}(\bar{\mathcal{A}}) = \bar{\mathcal{A}}'$. Then the diffeomorphism \bar{F} defined by $\bar{F} := \bar{H}^{-1}\bar{G}$ satisfies the assertions of the statement. \square

Arcs.

For all i, j, k in $\{1, 2, 3\}$, let us denote by $\text{Arc}_j^k(i)$ the set of closures of the connected components of $\bar{a}_i \setminus (\bar{a}_j \cup \bar{a}_k)$. We will say that an element of $\text{Arc}_j^k(i)$ is an *arc included in \bar{a}_i with extremities in \bar{a}_j and \bar{a}_k* .

Step 3. *The arcs of $\text{Arc}_1^1(2)$ and $\text{Arc}_3^3(2)$ are included respectively in \bar{T}_1 and \bar{T}_3 . In other words, the only arcs included in $\bar{a}_2 \cap \bar{S}$ belong to $\text{Arc}_1^1(2)$.*

Proof of step 3. Let us argue by contradiction. Let us consider an arc $\bar{\ell}$ belonging to $\text{Arc}_1^1(2)$ and included in \bar{S} . Since \bar{S} is of genus zero, $\bar{\ell}$ separates \bar{S} in two connected components. One of them contains the boundary \bar{a}_3 . Since the curves \bar{a}_1 and \bar{a}_2 do not cobound any bigon, the other component is not a disk, so it contains a special boundary component or a natural boundary component. In both cases, let us call d this boundary component. Finally, we have a path $\bar{\ell}$ which separates \bar{S} in two components, one containing \bar{a}_3 , the other containing d . Similarly $\bar{F}(\bar{\ell})$ belongs to $\text{Arc}_3^3(2)$ (for $\bar{\ell}$ belongs to $\text{Arc}_1^1(2)$), is included in \bar{S} and separates \bar{S} in two components, one containing $\bar{F}(\bar{a}_3)$ that is equal to \bar{a}_1 , the other containing $\bar{F}(d)$ that is equal to d . We deduce from it Figure 19 where it is clear that $\bar{\ell}$ and $\bar{F}(\bar{\ell})$ intersect, which is absurd: $\bar{F}(\bar{\ell})$ and $\bar{\ell}$ cannot intersect, for they are both included in the same curve. \square

Arc paths, rectangles, hexagons, octagons.

We call *arc path* a union of arcs such that this union is homeomorphic to a segment or to a circle. In the first case, the arc path will be said to be *open*, in the second it will be said to be *closed*.

If a connected component D of $\bar{T}_2 \cap \bar{T}_1$, of $\bar{T}_2 \cap \bar{S}$, or of $\bar{T}_2 \cap \bar{T}_3$ is homeomorphic to a disk whose boundary is a closed arc path, each of the arcs of this arc path will be called *edge of D* . Such a connected component with four edges will be called a *rectangle*, with six edges a *hexagon*, and with eight edges an *octagon*.

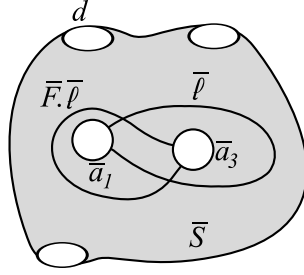

Figure 19: The existence of an arc $\bar{\ell}$ in $\text{Arc}_1^1(2)$ induces the existence of an arc $\bar{F}(\bar{\ell})$ in $\text{Arc}_3^3(2)$ intersecting $\bar{\ell}$.

Step 4. *The connected components of $\bar{T}_2 \cap \bar{S}$ are rectangles. The connected components of $\bar{T}_2 \cap \bar{T}_1$ (respectively $\bar{T}_2 \cap \bar{T}_3$) consist in exactly one hexagon and some rectangles.*

Proof of step 4.

1. *connected components of $\bar{T}_2 \cap \bar{S}$.*

We can see \bar{S} as an annulus whose boundary components are \bar{a}_1 and \bar{a}_3 , minus $\frac{n}{2} - 2 + b$ open disks, corresponding to the curves a_i , $i \in \text{Odd}(n) \setminus \{1, 3\}$ and to the boundary components of Σ (cf. Figure 20). The torus \bar{T}_2 contains none of these curves and none of these boundary components so the connected components of $\bar{T}_2 \cap \bar{S}$ are simply connected and of genus zero, hence are homeomorphic to disks. All the boundary components of a component \bar{C} of $\bar{T}_2 \cap \bar{S}$ are some arc paths leaning on the curves \bar{a}_1 , \bar{a}_2 and \bar{a}_3 . But we have seen that the arcs included in $\bar{a}_2 \cap \bar{S}$ belong to $\text{Arc}_1^3(2)$. It is easy to see that in such an annulus, the only injective arc paths that contain some arcs of $\text{Arc}_1^3(2)$ and that bound disks are rectangles: two edges belong to $\text{Arc}_1^3(2)$, one edge to $\text{Arc}_2^2(1)$ and one edge to $\text{Arc}_2^2(3)$.

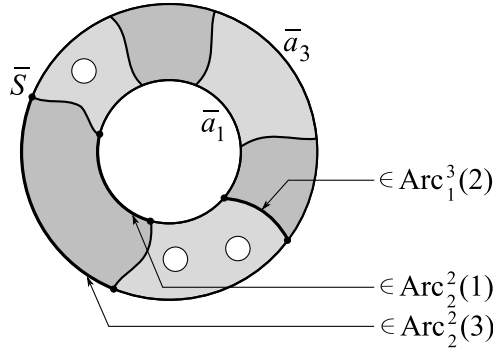

Figure 20: The surface \bar{S} is seen as an annulus, the dark grey parties are the connected components of $\bar{T}_2 \cap \bar{S}$.

2. *Connected components of $\bar{T}_2 \cap (\bar{T}_1 \cup \bar{T}_3)$.*

We can see \bar{T}_2 as the gluing along arcs included in \bar{a}_1 and \bar{a}_3 of the connected components of $\bar{T}_2 \cap \bar{T}_1$, $\bar{T}_2 \cap \bar{S}$ and $\bar{T}_2 \cap \bar{T}_3$. In this proof, we call *domains* these connected components. A domain of $\bar{T}_2 \cap \bar{T}_1$ is bounded by some arcs belonging to $\text{Arc}_2^2(1)$ and to $\text{Arc}_1^1(2)$. Notice that in \bar{T}_1 (as in any such torus with one hole), there exist at most three pairwise disjoint, non-isotopic

arcs, whose extremities belong to $\partial\bar{T}_1$. So the set of arcs in $\text{Arc}_1^1(2)$ contains at most three isotopy classes (cf. Figure 21).

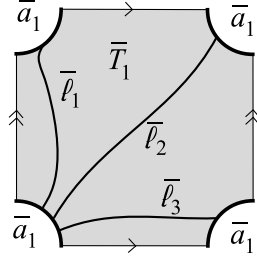

Figure 21: An example of three disjoint, non-isotopic arcs belonging to $\text{Arc}_1^1(2)$, in \bar{T}_1 .

But the arcs of $\text{Arc}_1^1(2)$ and of $\text{Arc}_2^2(1)$ constitute the boundary components of the domains of $\bar{T}_1 \cap \bar{T}_2$. We deduce that there exist only four possible types of domains in \bar{T}_1 : rectangles, hexagons, octagons and *cylinders with bigonal boundary components*, that is to say spheres with two boundary components, such that each is a path of two arcs (cf. Figure 22).

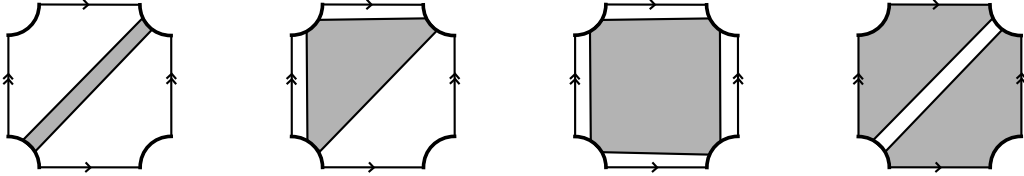

Figure 22: The four types of domains: from left to right: the rectangle, the hexagon, the octagon, the cylinder with bigonal boundary components.

The connected components of $\bar{T}_3 \cap \bar{T}_2$ satisfy the same properties, since they are the images by the diffeomorphism \bar{F} of step 2 of the connected components of $\bar{T}_1 \cap \bar{T}_2$.

3. Euler characteristic computation.

We are going to determine the contribution of each domain to the Euler characteristic of \bar{T}_2 (equal to -1 since \bar{T}_2 is a torus with one hole). Let us recall that \bar{T}_2 is the gluing of the domains along the arcs of $\text{Arc}_2^2(1) \cup \text{Arc}_2^2(3)$ included in \bar{T}_2 . Hence if a domain D has exactly k edges belonging to $\text{Arc}_2^2(1) \cup \text{Arc}_2^2(3)$, then its contribution to $\chi(\bar{T}_2)$ amounts to $\chi(D) - \frac{k}{2}$. Indeed, when we add up the Euler characteristics of all the domains, each of the gluing arcs has been counted twice. To compute the contribution of a domain to the Euler characteristic of \bar{T}_2 , we hence need to add to its own Euler characteristic $-\frac{1}{2}$ as a corrective term for each gluing arc included in the boundary of D . Thus,

- the rectangles have a 0-contribution;
- the hexagons have a $(-\frac{1}{2})$ -contribution;
- the cylinders with bigonal boundary components have a (-1) -contribution;
- the octagons have a (-1) -contribution.

But according to step 2, the domains of $\bar{T}_2 \cap \bar{T}_3$ are diffeomorphic to the ones of $\bar{T}_2 \cap \bar{T}_1$. Besides, the contribution of the domains of $\bar{T}_2 \cap \bar{S}$ is zero, since all the domains of $\bar{T}_2 \cap \bar{S}$ are rectangles (as

we have seen it in step 1.). Hence the global contribution of the domains of $\bar{T}_2 \cap \bar{T}_1$ and the global contribution of the domains of $\bar{T}_2 \cap \bar{T}_3$ must both equal $-\frac{1}{2}$. Therefore $\bar{T}_2 \cap \bar{T}_1$ contains exactly one hexagon and some rectangles. Same thing for $\bar{T}_2 \cap \bar{T}_3$. (An example of the torus \bar{T}_2 built up from two hexagons and some rectangles, according to the conclusion of step 4, is given Figure 23.) \square

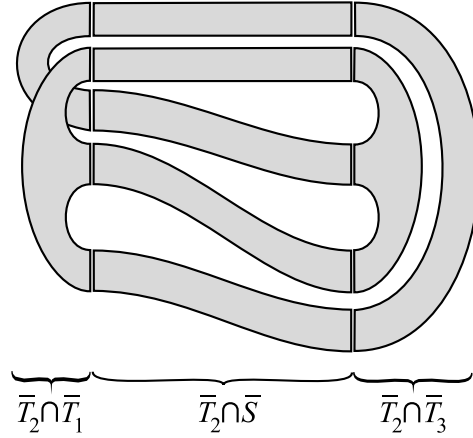

Figure 23: The torus \bar{T}_2 , built up from two hexagons and some rectangles.

Step 5. *We end in a contradiction.*

Proof of step 5 and end of the proof of Proposition 8.1.

The torus \bar{T}_3 contains the connected components of $\bar{T}_2 \cap \bar{T}_3$ and of $\bar{T}_4 \cap \bar{T}_3$, which are pairwise disjoint since $\bar{T}_2 \cap \bar{T}_4 = \emptyset$. There are two hexagons among them, one included in $\bar{T}_2 \cap \bar{T}_3$, the other included in $\bar{T}_4 \cap \bar{T}_3$. Each of them contains three edges included in \bar{a}_3 (cf. Figure 24).

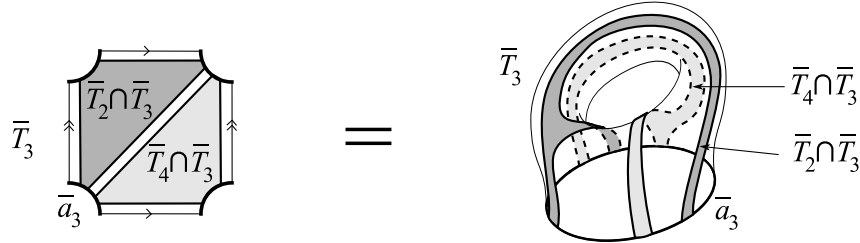

Figure 24: Two disjoint hexagons, one included in $\bar{T}_2 \cap \bar{T}_3$, the other included in $\bar{T}_4 \cap \bar{T}_3$.

Let us recall that it is possible to include in a torus with one hole only three pairwise disjoint and non-isotopic arcs with extremities in the boundary. Therefore our two hexagons are arranged as in Figure 24. In particular, let us remember that:

$$\begin{aligned} & \text{the six edges included in the boundary of the torus } \bar{T}_3 \text{ belong} \\ & \text{alternatively to one and to the other of the two tori } \bar{T}_2 \text{ and } \bar{T}_4. \end{aligned} \quad (1)$$

Let us describe how the tori \bar{T}_2 and \bar{T}_4 are embedded in Σ . The following description is depicted in Figure 25.

1. Since $\bar{T}_2 \cap \bar{T}_3$ contains a hexagon, $\bar{T}_2 \cap \bar{a}_3$ contains at least three connected components.

2. These at least three connected components extend in $\bar{T}_2 \cap \bar{S}$ in at least three rectangles. Indeed, let us recall that the rectangles of $\bar{T}_2 \cap \bar{S}$ have only one edge in \bar{a}_3 , so two distinct connected components of $\bar{T}_2 \cap \bar{a}_3$ are the edges of two distinct rectangles of $\bar{T}_2 \cap \bar{S}$. Now, there are at least three such rectangles in $\bar{T}_2 \cap \bar{S}$. Each of them has an edge in \bar{a}_1 and an edge in \bar{a}_3 . Since \bar{S} is of genus zero, we deduce that $\bar{S} \setminus \bar{T}_2$ contains at least three connected components. We will name by *region* each of these connected components.

3. For instance, consider the regions R_1, R_2, R_3 , in Figure 25. Since the two tori \bar{T}_2 and \bar{T}_4 are disjoint, the rectangles of $\bar{T}_4 \cap \bar{S}$ are inside some of these regions. However, all the rectangles of $\bar{T}_4 \cap \bar{S}$ have an edge included in \bar{a}_5 , so they should all be located in the region containing the curve \bar{a}_5 .

4. But this is impossible, for according to statement (1), there exist rectangles of $\bar{T}_4 \cap \bar{S}$ in at least three distinct regions (cf. Figure 25). \square

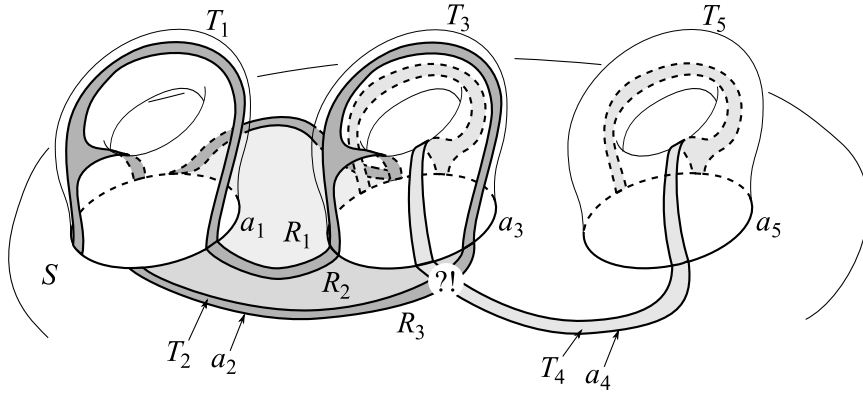

Figure 25: In this configuration where the hexagons $\bar{T}_2 \cap \bar{T}_3$ and $\bar{T}_4 \cap \bar{T}_3$ are “nested” in \bar{T}_3 , the tori \bar{T}_2 and \bar{T}_4 intersect, which should not happen yet.

9 Description of $\sigma(\mathcal{X})$ in Σ

Hypotheses.

Let $n \geq 6$ an even number, let $\Sigma = \Sigma_{g,b}$ with $g \leq \frac{n}{2}$, and let $\rho : \mathcal{B}_n \rightarrow \mathcal{PMod}(\Sigma)$ such that:

- ρ is non-cyclic by assumption,
- $\sigma_p(\mathcal{G}_0) = \emptyset$ by assumption, inspired by Proposition 4.7,
- $|\sigma_s(A_1)| \in \{1, 2\}$ according to 7.17
- curves of $\sigma_s(\mathcal{G}_0)$ are not separating according to Proposition 8.1

Recall that $\mathcal{X} = \{A_1, A_3, A_5, \dots, A_{n-1}\}$. In this section, we will determine the arrangement of the curves of $\sigma(\mathcal{X})$ in Σ while identifying the special curves and the normal curves. In other words, we will be able to describe the graphs $\Gamma(\Sigma; \sigma_s(\mathcal{X}))$ (cf. Definition ??) and $\Gamma(\Sigma; \sigma(\mathcal{X}))$. Our main tool will be the action of the subgroup \mathcal{H} of \mathcal{B}_n on the subset \mathcal{X} of \mathcal{G}_0 .

- In Subsection 9.1, we state a result concerning the action of \mathcal{H} on \mathcal{X} . We define notably the *\mathcal{H} -colorations*. They are \mathcal{H} -equivariant functions which will help us to express the constraints coming from the structure of \mathcal{B}_n on the characteristic elements of the mapping classes of \mathcal{G}_0 .
- In Subsection 9.2 we determine the graph $\Gamma(\Sigma, \sigma_s(\mathcal{X}))$ (cf. Proposition 9.3).

- In Subsection 9.3 we describe of the set $\sigma(\mathcal{X}) = \sigma_s(\mathcal{X}) \cup \sigma_n(\mathcal{X})$ with Propositions 9.4 and 9.6.

9.1 Action of \mathcal{H} on \mathcal{X} and \mathcal{H} -colorations

Let us recall the definitions of the group \mathcal{H} and of the subset \mathcal{X} of \mathcal{G}_0 (cf. Subsection 8.1). For any nonzero integer m , let $\text{Odd}(m)$ be the set of the first odd integers smaller than or equal to m . Let \mathcal{X} be the subset $\{A_i, i \in \text{Odd}(n)\}$ of \mathcal{G}_0 consisting in $\frac{n}{2}$ elements which pairwise commute. We denote by $\sigma(\mathcal{X})$ the curve simplex $\cup_{i \in \text{Odd}(n)} \sigma(A_i)$. We set $\sigma_s(\mathcal{X}) = \sigma(\mathcal{X}) \cap \sigma_s(\mathcal{G}_0)$. The group \mathcal{H} is the subgroup $\langle \gamma_i, i \in \text{Odd}(n) \rangle$ of \mathcal{B}_n where for all $i \in \text{Odd}(n)$, the element γ_i is the product $\tau_i \tau_{i+1} \tau_i \tau_{i+2} \tau_{i+1} \tau_i$.

Let us also recall the main properties of \mathcal{H} (see Proposition 8.2):

- i) The action of \mathcal{H} on $\mathcal{P}\text{Mod}(\Sigma)$ via ρ preserves \mathcal{X} . Indeed, for all $i, j \in \text{Odd}(n)$, we have:

$$\gamma_i \cdot A_j = \rho(\gamma_i) A_j \rho(\gamma_i)^{-1} = \begin{cases} A_j & \text{if } i \notin \{j, j-2\} \\ A_{j-2} & \text{if } i = j-2 \\ A_{j+2} & \text{if } i = j. \end{cases}$$

- (ii) The homomorphism $\mathcal{H} \rightarrow \mathfrak{S}(\mathcal{X})$ describing the action of \mathcal{H} on \mathcal{X} , where $\mathfrak{S}(\mathcal{X})$ is the symmetric group on the elements of \mathcal{X} , is surjective. In particular, this action is $\frac{n}{2}$ times transitive.
- (iii) The action of \mathcal{H} on $\mathcal{C}\text{urv}(\Sigma)$ preserves $\sigma_s(\mathcal{X})$.

We have already given the definition of \mathcal{J} -coloration in Subsection 7.2. We define what is a \mathcal{H} -coloration in the same way.

\mathcal{H} -colorations on \mathcal{X} .

Let \mathcal{E} be an \mathcal{H} -set (i.e. a set together with an action of \mathcal{H}) and $\mathcal{P}(\mathcal{E})$ the power set of \mathcal{E} . An \mathcal{H} -coloration is a function $\text{col}_{\mathcal{X}} : \mathcal{X} \rightarrow \mathcal{P}(\mathcal{E})$ that is \mathcal{H} -equivariant, which means that for all $\xi \in \mathcal{H}$ and all $A \in \mathcal{X}$, we have:

$$\xi \cdot \text{col}_{\mathcal{X}}(A) = \text{col}_{\mathcal{X}}(\xi \cdot A).$$

The integers of $\text{Odd}(n)$, in bijection with \mathcal{X} , are called *colors*. We will say that an element $e \in \mathcal{E}$ is of color i if $e \in \text{col}_{\mathcal{X}}(A_i)$. An element $e \in \mathcal{E}$ can be of several colors in the meantime or possibly of none color.

Conversely, starting from a \mathcal{H} -coloration $\text{col}_{\mathcal{X}} : \mathcal{X} \rightarrow \mathcal{P}(\mathcal{E})$, let us define the map called \mathcal{H} -spectrum:

$$\text{sp}_{\mathcal{X}} : \begin{array}{ccc} \mathcal{E} & \longrightarrow & \mathcal{P}(\mathcal{X}) \\ e & \longmapsto & \{A \in \mathcal{X} \mid e \in \text{col}_{\mathcal{X}}(A)\} \end{array} .$$

The map $\text{sp}_{\mathcal{X}}$ is \mathcal{H} -equivariant: for all $\xi \in \mathcal{H}$ and all $e \in \mathcal{E}$, we have:

$$\xi \cdot \text{sp}_{\mathcal{X}}(e) = \text{sp}_{\mathcal{X}}(\xi \cdot e).$$

Proposition 9.1. *The map $\sigma_s : \mathcal{X} \rightarrow \mathcal{C}\text{urv}(\Sigma)$ is an \mathcal{H} -coloration.*

Proof. According to Proposition ??.(i), we have $\sigma(\gamma.A) = \gamma.\sigma(A)$ for any $\gamma \in \mathcal{B}_n$ and any $A \in \mathcal{P}\text{Mod}(\Sigma)$, so the function Σ is an \mathcal{H} -coloration on $\sigma(\mathcal{X})$. Moreover, $\sigma_s(\mathcal{X})$ is \mathcal{H} -stable, according to Proposition 8.2). Then for all $i, j \in \text{Odd}(n)$, we have:

$$\begin{aligned}\sigma_s(\gamma_i.A_j) &= \sigma(\gamma_i.A_j) \cap \sigma_s(\mathcal{X}) \\ &= \gamma_i.\sigma(A_j) \cap \sigma_s(\mathcal{X}) \\ &= \gamma_i.\sigma(A_j) \cap \gamma_i.\sigma_s(\mathcal{X}) \\ &= \gamma_i.(\sigma(A_j) \cap \sigma_s(\mathcal{X})) \\ &= \gamma_i.\sigma_s(A_j).\end{aligned}$$

So the restriction of the function σ on \mathcal{X} is an \mathcal{H} -coloration. \square

Lemma 9.2. *Let \mathcal{E} be an \mathcal{H} -set. Let $\text{col}_{\mathcal{X}} : \mathcal{X} \rightarrow \mathcal{P}(\mathcal{E})$ be an \mathcal{H} -coloration and $\text{sp}_{\mathcal{X}} : \mathcal{E} \rightarrow \mathcal{P}(\mathcal{X})$ the associated \mathcal{H} -spectrum. Let e be an element of \mathcal{E} such that the \mathcal{H} -spectrum of e contains k mapping classes ($0 \leq k \leq \frac{n}{2}$). Then there exists an integer $\ell \geq 1$ such that $|\mathcal{H}.e| = \ell C_r^k$ where $r = \frac{n}{2}$.*

Proof. This is an easy application of general principles about group actions. In a general way, if \mathcal{F} is a finite set on which \mathcal{H} acts, if we choose an element $f_0 \in \mathcal{F}$ and if we denote by $S = \text{Stab}_{\mathcal{H}}(f_0)$ the subgroup of \mathcal{H} that fixes f_0 , and by \mathcal{Z} a transversal of \mathcal{H}/S , then,

- we have the disjoint union $\mathcal{H} = \bigsqcup_{\gamma \in \mathcal{Z}} \gamma.S$
- if the action of \mathcal{H} on \mathcal{F} is transitive, we have $|\mathcal{Z}| = |\mathcal{H}/S| = |\mathcal{F}|$.

Given an element e of \mathcal{E} such that $\text{sp}_{\mathcal{X}}(e)$ is a set of k mapping classes of \mathcal{X} with $0 \leq k \leq r$ where $r = \frac{n}{2}$, let us consider the set $\mathcal{P}_k(\mathcal{X})$ of the subsets of \mathcal{X} containing k elements. We replace \mathcal{F} by $\mathcal{P}_k(\mathcal{X})$ and f_0 by $\text{sp}_{\mathcal{X}}(e)$. Notice that the action of \mathcal{H} on $\mathcal{P}_k(\mathcal{X})$ is transitive for the action of \mathcal{H} on \mathcal{X} is k times transitive. We get then:

$$\mathcal{H} = \bigsqcup_{\gamma \in \mathcal{Z}} \gamma.\text{Stab}_{\mathcal{H}}(\text{sp}_{\mathcal{X}}(e)), \quad (1)$$

$$\text{and } |\mathcal{Z}| = |\mathcal{H}/\text{Stab}_{\mathcal{H}}(\text{sp}_{\mathcal{X}}(e))| = |\mathcal{P}_k(\mathcal{X})| = \binom{r}{k}. \quad (2)$$

Now for all distinct γ' and γ'' belonging to \mathcal{Z} , the elements $\gamma'.\text{sp}_{\mathcal{X}}(e)$ and $\gamma''.\text{sp}_{\mathcal{X}}(e)$ are different, so the elements of $\gamma'.(\text{Stab}_{\mathcal{H}}(\text{sp}_{\mathcal{X}}(e)).e)$, that all have the same spectrum, which is different from the spectrum of the elements of $\gamma''.(\text{Stab}_{\mathcal{H}}(\text{sp}_{\mathcal{X}}(e)).e)$. Hence the two sets $\gamma'.(\text{Stab}_{\mathcal{H}}(\text{sp}_{\mathcal{X}}(e)).e)$ and $\gamma''.(\text{Stab}_{\mathcal{H}}(\text{sp}_{\mathcal{X}}(e)).e)$ are disjoint. Therefore, the assertion (1) implies:

$$\mathcal{H}.e = \bigsqcup_{\gamma \in \mathcal{Z}} \gamma.(\text{Stab}_{\mathcal{H}}(\text{sp}_{\mathcal{X}}(e)).e), \quad (3)$$

We set $\ell = |(\text{Stab}_{\mathcal{H}}(\text{sp}_{\mathcal{X}}(e)).e)|$. Then, we deduce from (2) and (3) the following equality:

$$|\mathcal{H}.e| = \ell \binom{r}{k}. \quad (4)$$

\square

9.2 Description of the embedding of $\sigma_s(\mathcal{X})$ in Σ

This subsection is devoted to the proof of the following proposition.

Proposition 9.3 (Arrangement of the curves of $\sigma_s(\mathcal{X})$ in Σ).

- (i) The set $\sigma_s(\mathcal{G}_0)$ contains n curves (hence for all $A \in \mathcal{G}_0$, we have $|\sigma_s(A)| = 1$).
- (ii) The set $\sigma_s(\mathcal{X})$ is non-separating in Σ , or it is separating but for any $a \in \sigma_s(\mathcal{X})$, the set of curves $\sigma_s(\mathcal{X}) \setminus \{a\}$ is non-separating. In other words, the graph $\Gamma(\Sigma, \sigma_s(\mathcal{X}))$ is one of those depicted in Figure 26.

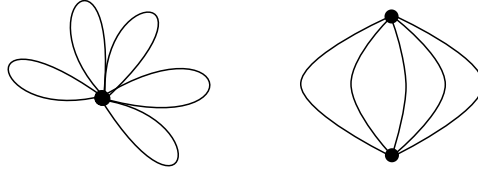

Figure 26: The two possible embeddings of $\sigma_s(\mathcal{X})$ in Σ (here $n = 10$).

Proof. According to Proposition 7.17, $\sigma_s(\mathcal{G}_0)$ contains n or $2n$ curves, depending on whether $\sigma_s(A_1)$ contains one or two curves. Since \mathcal{X} contains only the mapping classes with odd indices, $\sigma_s(\mathcal{X})$ contains $\frac{n}{2}$ or n curves. While showing item (ii) we will show that $\sigma_s(\mathcal{X})$ contains $\frac{n}{2}$ curves, which will prove item (i).

Let us show that if we prove this proposition in the case where $\partial\Sigma$ is empty, then the proposition in the case where $\partial\Sigma$ is not empty can be deduced easily. So, we assume that $\partial\Sigma$ is not empty. Let us consider the graph $\Gamma(\Sigma, \sigma_s(\mathcal{X}))$ and the subgroup \mathcal{H} preserving the simplex $\sigma_s(\mathcal{X})$. Since the cardinality of each orbit of curves of $\sigma_s(\mathcal{X})$ under \mathcal{H} is greater than or equal to $\frac{n}{2} \geq 3$, we can apply Proposition 4.9. In other words, $\Gamma(\Sigma, \sigma_s(\mathcal{X}))$ is canonically isomorphic to $\Gamma(\text{sq}(\Sigma), \text{sq}(\sigma_s(\mathcal{X})))$ that is the graph associated to the homomorphism $\text{sq}^* \circ \rho : \mathcal{B}_n \rightarrow \text{Mod}(\text{sq}(\Sigma))$, in the same way as the graph $\Gamma(\Sigma, \sigma_s(\mathcal{X}))$ is associated to the homomorphism $\rho : \mathcal{B}_n \rightarrow \mathcal{P}\text{Mod}(\Sigma)$. Thanks to this isomorphism, in order to prove Proposition 9.3, it is enough to show the parts (i) and (ii) when $\partial\Sigma$ is empty.

From now on, we assume that $\partial\Sigma$ is empty. We are going to use the action of \mathcal{H} on the graph $\Gamma(\Sigma, \sigma_s(\mathcal{X}))$. In order to make the action of \mathcal{H} on the graph $\Gamma(\Sigma, \sigma_s(\mathcal{X}))$ more obvious, we “color in” the different edges and the different vertices as follows:

The graph $\Gamma = \Gamma(\Sigma, \sigma_s(\mathcal{X}))$.

We denote by Γ the graph $\Gamma(\Sigma, \sigma_s(\mathcal{X}))$. Its vertices are in bijection with $\text{Sub}_{\sigma_s(\mathcal{X})}(\Sigma)$ and its edges are in bijection with $\sigma_s(\mathcal{X})$. The action of \mathcal{H} on $\text{Sub}_{\sigma_s(\mathcal{X})}(\Sigma)$ induces an action of \mathcal{H} on the set of vertices of Γ and the action of \mathcal{H} on $\sigma_s(\mathcal{X})$ induces an action of \mathcal{H} on the set of edges of Γ . Moreover, these two actions are compatible with the graph structure of Γ . In addition, we also have two \mathcal{H} -colorations:

- the \mathcal{H} -coloration $\sigma_s : \mathcal{X} \rightarrow \sigma_s(\mathcal{X})$, that can be seen as an \mathcal{H} -coloration on the edges of Γ . In this way, the \mathcal{H} -spectrum of each edge of Γ contains a unique color $i \in \text{Odd}(n)$;

- the \mathcal{H} -coloration $\omega_{\mathcal{X}}$: $\begin{array}{ccc} \mathcal{X} & \longrightarrow & \text{Sub}_{\sigma_s(\mathcal{X})}(\Sigma) \\ A & \longmapsto & \{S \in \text{Sub}_{\sigma_s(\mathcal{X})}(\Sigma) \mid \text{Bndy}(S) \cap \sigma_s(A) \neq \emptyset\} \end{array}$, that can

be seen as an \mathcal{H} -coloration on the vertices of Γ . Thus the \mathcal{H} -spectrum of each vertex contains exactly the colors of the edges incident to this vertex.

Since σ_s and $\omega_{\mathcal{X}}$ are \mathcal{H} -colorations, the action of \mathcal{H} on the vertices and on the edges of Γ is compatible with the action of \mathcal{H} on their colors. Finally, the group \mathcal{H} acts on the graph Γ together with its colors.

The cycles and the degrees in Γ .

Let us denote by c the number of independent cycles which exist in Γ . Then, we have of course:

Fact 1: $c \leq g$.

The vertices of degree 1 correspond to the subsurfaces bounded by some separating curves. However, according to Proposition 8.1, there does not exist in $\sigma_s(\mathcal{X})$ any separating curve in Σ , so:

Fact 2: *The degree of each vertex is at least 2.*

Hence the graph Γ contains some cycles:

Fact 3: $c \geq 1$.

Notice that the vertices of degree 2 correspond to the connected components having only two boundary components. Remember that $\partial\Sigma$ is empty, so such connected components must be of nonzero genus. We deduce:

Fact 4: *The number of vertices of degree 2 is bounded by $g - c$.*

Moreover, if there exists a vertex p of degree 2, such that i and j in $\text{Odd}(n)$ are the colors of the two edges having an extremity in p , the orbit of p under the action of \mathcal{H} is of cardinality at least $\frac{n}{2}$ if $i = j$, and of cardinality at least $\binom{\frac{n}{2}}{2} \geq \frac{n}{2}$ if $i \neq j$, according to Lemma 9.2. But according to Facts 3 and 4, this number should be bounded by $g - 1$. However, $g - 1 < \frac{n}{2}$, so finally:

Fact 5: *There does not exist any vertex of degree 2.*

We are going to treat separately the graphs containing some edges whose both extremities are equal, from the graphs where both extremities of each edges are distinct.

Petals. Let us call *petal* an edge whose both extremities are equal.

Graphs with petals. If there exist some petal in Γ , then there exist some in each color, so there exist at least $\frac{n}{2}$ petals. But each petal produces an independent cycle of Γ , and the number of independent cycles is bounded by g , and so by $\frac{n}{2}$. So we have $c = g = \frac{n}{2}$. Therefore, if there exist some petals in Γ , then there exist exactly $\frac{n}{2}$ petals and $g = \frac{n}{2}$. Moreover, since the maximal number of independent cycles is achieved just because of the petals, it follows that if we remove these $\frac{n}{2}$ petals from Γ , we get a tree. Since each edge is *separating* in a tree (we say that an edge is *separating* in a connected graph if removing this edge from the graph makes it disconnected), then all the edges in Γ that are not a petal are separating. But according to Proposition 8.1, $\sigma_s(\mathcal{X})$ does not contain any separating curves, so Γ contains no other edge but the $\frac{n}{2}$ petals. Therefore, the graph Γ is a rose, that is, a graph with only one vertex (cf. graph on the left-hand side on Figure 26).

Graphs without petals. Let us assume now that Γ is a graph without petals.

According to Proposition 7.17, for each $A \in \mathcal{G}_0$, the cardinality $|\sigma_s(A)|$ equals 1 or 2. In other words, for each $i \in \{0, 1, \dots, n-1\}$, there are only one or two curves in $\sigma_s(\mathcal{G}_0)$ that are in $\sigma_s(\mathcal{A}_i)$. In the graph Γ , this implies that:

Fact 6: *There exist at most two edges of a same color.*

If there is only one edge per color:

According to Facts 2 and 5, all the vertices are at least of degree 3. Since there is no petal, at least three distinct edges are incident to each vertex.

- When $n = 6$, since there is only one edge per color, Γ contains only three edges. Hence in the case $n = 6$, there exists exactly 2 vertices of degree 3 and the graph is drawn in Figure 26, left-hand side.
- Suppose now that $n \geq 8$. We take $j = n - 1$ and we set $\mathcal{H}_{n-2} = \langle \gamma_i, i \in \text{Odd}(n-2) \rangle$ so that \mathcal{H}_{n-2} is a subgroup of \mathcal{H} that fixes the color $n-1$ and acts $\frac{n}{2} - 1$ times transitively on the set of the $\frac{n}{2} - 1$ other colors of $\text{Odd}(n)$. Given a vertex q of degree v and an edge of color $n-1$ incident to q , according to Lemma 9.2, there should exist at least $\binom{\frac{n}{2} - 1}{v - 1}$ distinct vertices in the orbit of q under the action of \mathcal{H}_{n-2} . But there is only one edge of color $n-1$ in Γ , so there should be at most two vertices in the orbit of q under \mathcal{H}_{n-2} , including q . So $\binom{\frac{n}{2} - 1}{v - 1}$ must be equal to 1 or 2. Since $\frac{n}{2} - 1 \geq 3$ and $v - 1 \geq 2$, v must be equal to $\frac{n}{2}$. So the graph Γ is fully determined: there are exactly two vertices and $\frac{n}{2}$ edges incident to these two vertices: the graph is drawn in Figure 26, right-hand side.

If there are exactly two edges per color:

We suppose from now on that there exist two curves in each color.

We want to show that this case is absurd.

Notice that we have the following:

Fact 7: *Two edges of the same color cannot have the same extremities.*

Proof. Assume that two edges of a same color have the same extremities. Then they would form a cycle, and we can associate their color to this cycle. We would obtain $\frac{n}{2}$ independent cycles of distinct colors, hence the equalities $c = g = \frac{n}{2}$ would hold and it would not exist other independent cycles in Γ , according to Fact 1. It would not exist either other edges than the n edges constituting these $\frac{n}{2}$ cycles, according to Fact 6. Let us identify in Γ two edges if they have the same color and let us call Γ' this new graph (cf. Figure 27). The graph Γ' is a tree, so it contains leaves (vertices of degree 1). These leaves correspond in Γ to vertices of degree 2. But this is forbidden, according to Fact 5. Hence Fact 7 is shown. \square

Let us go further:

Fact 8: *Two edges of the same color cannot share an extremity in common.*

Proof. We argue again by contradiction. We suppose that two edges of the same color share an extremity in common (if this is true for one color, this must be true for each color). Let us recall that there exist only two edges of the same color, according to Fact 6. Let us also recall that

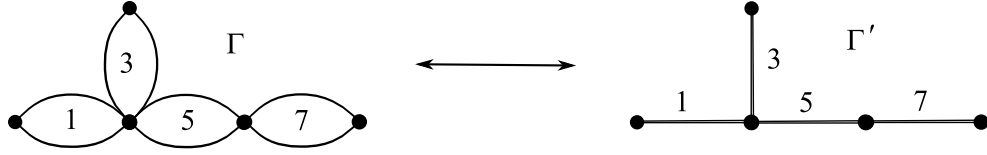

Figure 27: Case $g \geq 4$, when two edges of a same color have the same extremities.

two such edges cannot have the same extremities, according to Fact 7. So for all $i \in \text{Odd}(n)$, there exists only one vertex that is a common extremity the two edges of color i . We will call it p_i . By symmetry of the action of \mathcal{H} on \mathcal{X} , the p_i are all distinct or all equal.

- a) **The vertices p_i , $i \in \text{Odd}(n)$, coincide.** We keep in mind Figure 28. Let us call p the vertex $p_1 = p_3 = \dots = p_{n-1}$. The vertex p is at least of degree n . It cannot be of a greater degree, for there is no petal in Γ , by assumption. Thus, each on the n edges in Γ has an extremity in p . The number of the other extremities is n , and they are incident to vertices distinct from p . But since these vertices are of degree greater than or equal to 3 according to Facts 2 and 5, their number is at most $\frac{n}{3}$. So, Γ contains n edges and at most $1 + \frac{n}{3}$ vertices, so its number of independent cycles is at least of $1 + n - (\frac{n}{3} + 1) = \frac{2n}{3}$. But this is absurd for $\frac{2n}{3} > \frac{n}{2} \geq g$.

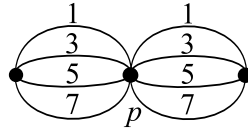

Figure 28: Example of graph where all the p_i coincide.

- b) **The vertices p_i , $i \in \text{Odd}(n)$, are pairwise distinct.** We keep in mind Figure 29. As the p_i are not of degree 2, according to Fact 5, each p_i is the extremity of the two edges of color i and of at least an edge of color $j \neq i$. But the subgroup of \mathcal{H} that fixes the color i acts transitively on the other colors, so p_i is also the extremity of an edge of color k for all $k \in \text{Odd}(n) \setminus \{i\}$. Thus p_i is of degree at least $\frac{n}{2} + 1$ (actually, this must be an equality with our assumptions). As we know that there is at least $\frac{n}{2}$ vertices in Γ (think of the p_i , $i \in \text{Odd}(n)$), we deduce that the degrees of all the vertices in Γ sum to at least $\frac{n}{2}(\frac{n}{2} + 1)$. Now, this sum should be equal to two times the number of edges. Since there are exactly n edges in Γ , we have the equality:

$$\frac{n}{2}(\frac{n}{2} + 1) \leq 2n. \quad (*)$$

We get then $n^2 + 2n \leq 8n$, hence $n \leq 6$. By hypothesis, $n \geq 6$, so $n = 6$ and $(*)$ is an equality and becomes: $\frac{n}{2}(\frac{n}{2} + 1) = 12$. That means that the vertices in Γ is reduced to the set $\{p_1, p_3, p_5\}$. The graph now is perfectly determined, and drawn in Figure 29. But this graph contains $c = 1 + 6 - 3 = 4$ independent cycles, which is absurd for $c \leq g \leq \frac{n}{2} = 3$.

Thus, Fact 8 is shown. □

Now, with these eight facts, we can terminate the proof of Proposition 9.3. Remember that we assume that $|\sigma_s(\mathcal{X})| = n$. We prove separately the cases $n = 6$ and $n \geq 8$. We start by the case $n \geq 8$ which is the easiest one.

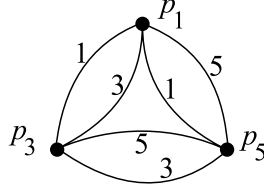

Figure 29: Example of a graph where the p_i are distinct.

Let us show that the conditions $|\sigma_s(\mathcal{X})| = n$ and $n \geq 8$ lead to a contradiction.

Let us denote by S the number of vertices. Since Γ has n edges, the number of independent cycles must satisfy $c = 1 + n - S \leq \frac{n}{2}$. Hence:

$$S \geq \frac{n}{2} + 1.$$

Let v be the minimum degree among the vertices of Γ . We have seen, according to Facts 2 and 5 that $v \geq 3$. But the sum of the degrees of all the vertices of Γ is at least equal to vS . On the other hand, it must be equal to two times the number of vertices. Hence we have $2n \geq vS$, so:

$$S \leq \frac{2n}{v}.$$

It is then absurd that $v \geq 4$ for we would have $\frac{n}{2} + 1 \leq S \leq \frac{n}{2}$. Now, suppose that $v = 3$. Thanks to Fact 8, we know that all the edges incident to a vertex are of pairwise distinct colors, so when $v = 3$, to each vertex corresponds a choice of three colors among $\frac{n}{2}$. According to Lemma 9.2, we have then at least $\binom{\frac{n}{2}}{3}$ vertices in Γ . When $n \geq 10$, we check that $\binom{\frac{n}{2}}{3} \geq n$, so this leads to the following contradiction:

$$n \leq \binom{\frac{n}{2}}{3} \leq S \leq \frac{2n}{3}.$$

When $n = 8$, since $v = 3$, there exists an orbit of vertices of degree 3. The cardinality of this orbit is a multiple of 4 vertices, according to Lemma 9.2. But as there exists 8 edges in Γ and consequently 16 half-edges, there must exist in Γ exactly 4 vertices of degree 3 and one vertex of degree 4 (replace the vertex of degree 4 by two vertices of degree 2 is forbidden by Fact 5) to satisfy the equality: $16 = 3 \times 4 + 1 \times 4$. We thus get a graph similar to those depicted in Figure 30. Let us call P_1, P_3, P_5 and P_7 the four vertices of degree 3 and Q the vertex of degree 4, as in Figure 30. The subgroup of \mathcal{H} that fixes the color 1 does not preserve such a graph, for it fixes the vertices P_1 and Q but modifies the color of the unique edge that joint the vertices P_1 and Q : this edge can be of color 3, 5 or 7, and gives rise to different graphs (in Figure 30, we give two examples with 7 and 5). Hence this case $n = 8$ is absurd. Finally, the conditions $|\sigma_s(\mathcal{X})| = n$ and $n \geq 8$ lead only to contradictions.

Let us show that the conditions $|\sigma_s(\mathcal{X})| = n$ and $n = 6$ lead to a contradiction.

According to Facts 2, 5 and 8, all the vertices are of degree 3, each being the extremity of three edges of colors 1, 3 and 5. We get the graph represented on Figure 31. Let us recall that according to Proposition 7.12 (5d) describing the equivalent properties of the special curves, each orbit of edges of $\sigma_s(\mathcal{X})$ under the action of $\mathcal{J} = \langle \delta \rangle$ is of cardinality $n = 6$, and each orbit of edges of $\sigma_s(\mathcal{X})$ under the action of $\langle \delta^2 \rangle$ is of cardinality $\frac{n}{2} = 3$. So we distinguish two orbits among the 6 curves of $\sigma_s(\mathcal{X})$, and the action of δ^2 on the graph Γ is periodic of order three. Then one of the vertices is preserved whereas the three others are cyclicly permuted. Let us call P the preserved vertex. Its boundary components form an orbit under the action of δ^2 , we

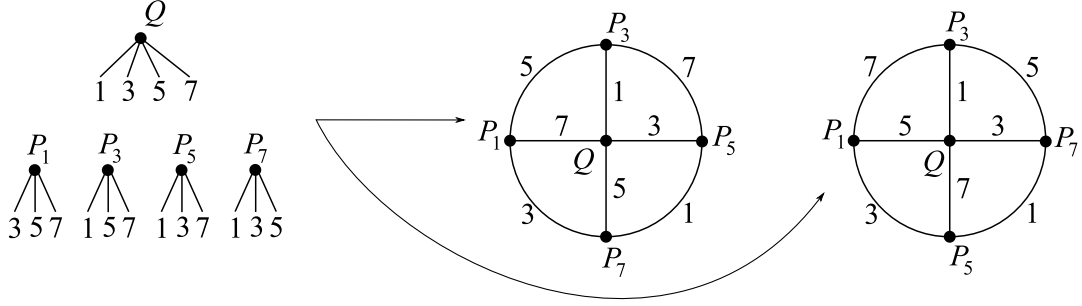

Figure 30: Two examples of *a priori* possible graphs with $n = 8$ and $|\sigma_s(\mathcal{X})| = 8$. (They are different, for Q and P_1 are joined by an edge of color 7 in one case, and 5 in the other. But, none of them is \mathcal{H} -stable since the action of γ_5 swap them.)

will call them a'_1, a'_3, a'_5 , where the indices respect the color of each curve. Let us call the other curves a_1, a_3, a_5 , where the indices respect the color of each curve. For all $i \in \{1, 3, 5\}$, let us denote by P_i the subsurface different from P that contains the curve a'_i in its boundary, see Figure 31.

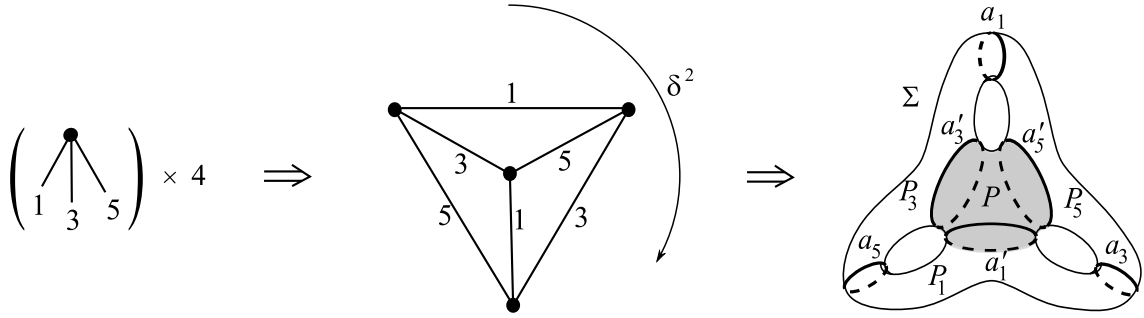

Figure 31: Case $n = 6$: the surface $\Sigma_{3,0}$ together with the curves of $\sigma_s(\mathcal{X})$ when $|\sigma_s(\mathcal{X})| = 6$.

We are going to show, by means of the special curves of $\mathcal{Y} = \mathcal{G}_0 \setminus \mathcal{X} = \{A_0, A_2, A_4\}$, that such a configuration cannot happen. Notice that $\sigma_s(\mathcal{G}_0)$ is a set of curves without triple intersection, so according to Proposition ??, there exists a unique system of representatives of the curves of $\sigma_s(\mathcal{G}_0)$ in tight position, up to isotopy. Moreover, any representative of the mapping class $\rho(\delta)$ sends such a system of representatives on itself, up to isotopy. Moreover, we have, $\sigma_s(\mathcal{Y}) = \delta.\sigma_s(\mathcal{X})$, and we denote by $a_0, a_2, a_4, a'_0, a'_2, a'_4$ the curves of $\sigma_s(\mathcal{Y})$, so as to be coherent with their colors, as we did with the curves of $\sigma_s(\mathcal{X})$. Let us consider the subsurface P_1 . Then:

- $a'_2 = \delta.a'_1$ and $a'_0 = \delta^{-1}.a'_1$, so according to Proposition 7.1, $I(a'_1, a'_2) = I(a'_1, a'_0) \neq 0$, hence $a'_0 \cap P_1$ and $a'_2 \cap P_1$ are not empty.
- Similarly if we consider the curves a_3 and a_5 , it follows that $I(a_3, a_4) = I(a_3, a_2) \neq 0$ and $I(a_5, a_0) = I(a_5, a_4) \neq 0$, so $a_0 \cap P_1, a_2 \cap P_1$ and $a_4 \cap P_1$ are not empty.
- Let x be a curve of $\sigma_s(\mathcal{Y})$ whose restriction to P_1 is a path with extremities in a same boundary component, and y another curve of $\sigma_s(\mathcal{Y})$ whose restriction to P_1 is a path with

extremities in the two other boundary components of P_1 . Then x and y must intersect, as illustrated in Figure 32 (two cases are to be considered, depending on whether the extremities of y belong to the same boundary of P_1 or not). But $\sigma_s(\mathcal{Y})$ is a curve simplex, so this situation cannot happen.



Figure 32: Case $n = 6$: the curve x and the curve y have to intersect.

- Let us apply the last point to the curves $x = a'_0$ and $y = a_4$. Suppose that the extremities of one of the connected components of $a'_0 \cap P_1$ lie in a'_1 . Notice that a_4 cannot intersect a'_1 , so the extremities of any connected component of $a_4 \cap P_1$ lie in $a_3 \cup a_5$. This leads to a contradiction as we just have seen it above. Therefore $a'_0 \cap P_1$ cannot contain any path with extremities in a'_1 . Hence $a'_0 \cap P_1$ consists in paths joining the boundary components a'_1 and a_5 . Similarly, $a'_2 \cap P_1$ consists in paths joining the boundary components a'_1 and a_3 .
- Let us now apply the last-but-one point to the curves $x = a_2$ and $y = a_0$. We conclude just as before that $a_2 \cap P_1$ cannot contain any path with extremities in a_3 . Similarly, if we take the curves $x = a_4$ and $y = a_0$, we see that $a_4 \cap P_1$ cannot contain any path with extremities in a_3 . The reader can check that in fact, no curve of $\sigma_s(\mathcal{Y})$ can contain some path in P_1 with extremities in a same boundary of P_1 . The situation is summed up in Figure 33.

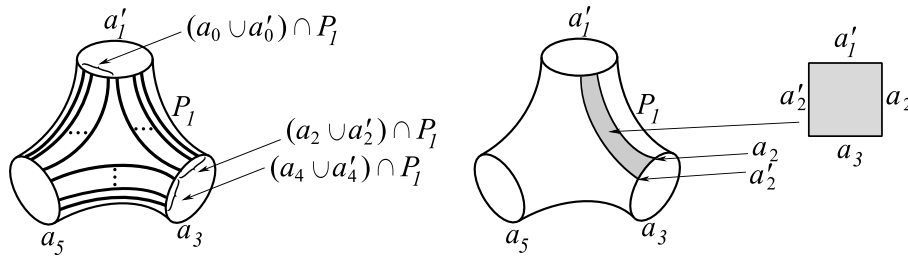

Figure 33: Case $n = 6$: the intersection of the curves of $\sigma_s(\mathcal{Y})$ and P_1 .

- Then, there exists in $\Sigma_{\sigma_s(\mathcal{G}_0)}$ a connected component homeomorphic to a disk whose boundary consists in four arcs of curves, each arc being included in a'_1 , a_2 , a'_2 and a_3 respectively. We then deduce that there exists in $\text{Sub}_{\sigma_s(\mathcal{Y})}(\Sigma)$ a subsurface bounded altogether by a_2 and a'_2 . Then, taking the image of this situation by $\rho(\delta^{-1})$, we deduce that there should exist in $\text{Sub}_{\sigma_s(\mathcal{X})}(\Sigma)$ a subsurface bounded altogether by a_1 and a'_1 . However, this is not the case. This is the expected contradiction.

Finally, the conditions $|\sigma_s(\mathcal{X})| = n$ and $n = 6$ lead to a contradiction. This concludes the proof of Proposition 9.3. \square

9.3 Description of $\sigma_n(\mathcal{G}_0)$ and of $\sigma(\mathcal{X})$ in Σ

According to Proposition 9.3, for all integers $i \in \{0, \dots, n-1\}$, the set of curves $\sigma_s(A_i)$ is reduced to a unique curve. We denote it by a_i . Since we know that the set $\sigma_s(\mathcal{X})$ is equal to $\{a_1, a_3, \dots, a_{n-1}\}$ and since we know how these curves are arranged in Σ (cf. Proposition 9.3), we turn now to the simplex $\sigma(\mathcal{X})$. Let us recall that according to Proposition 7.1, we have $\sigma_n(A_1) = \sigma_n(\mathcal{G}_0)$, whence the equality

$$\sigma(\mathcal{X}) = \sigma_s(\mathcal{X}) \cup \sigma_n(\mathcal{G}_0).$$

Recall that $\sigma(\mathcal{X})$ is a simplex since \mathcal{X} span an abelian group. Consequently, $\sigma_s(\mathcal{X})$ and $\sigma_n(\mathcal{G}_0)$ are also simplexes. Moreover, $I(\sigma_s(\mathcal{X}), \sigma_n(\mathcal{G}_0)) = 0$. Actually, we have the following, which is stronger, and which comes from the properties of the normal curves (see Proposition 7.1.(ii)):

$$I(\sigma_s(\mathcal{G}_0), \sigma_n(\mathcal{G}_0)) = 0.$$

Proposition 9.4 (Existence of the surface $\widehat{\Sigma}$).

- (i) *There exists a unique subsurface $\widehat{\Sigma}$ in $\text{Sub}_{\sigma_n(\mathcal{G}_0)}(\Sigma)$ that contains the curves of $\sigma_s(\mathcal{G}_0)$.*
- (ii) *The boundary of each subsurface belonging to $\text{Sub}_{\sigma_s(\mathcal{X})}(\widehat{\Sigma})$ contains $\sigma_s(\mathcal{X})$.*
- (iii) *The surface $\widehat{\Sigma}$ is of genus $\widehat{g} \in \{\frac{n}{2} - 1, \frac{n}{2}\}$.*
- (iv) *The surface Σ is of genus $g \in \{\frac{n}{2} - 1, \frac{n}{2}\}$.*
- (v) *The set $\text{Sub}_{\sigma_s(\mathcal{X})}(\widehat{\Sigma})$ is reduced to a connected component of genus zero, or to two connected components, one of them is of genus zero and the other is of genus zero or one.*

Proof.

Let us show item (i).

Let us recall that the normal curves do not intersect any curve of $\sigma(\mathcal{G}_0)$ and hence any special curve. For all $i \in \{0, 1, \dots, n-1\}$, let $\widehat{\Sigma}_i$ be the subsurface of $\text{Sub}_{\sigma_n(\mathcal{G}_0)}(\Sigma)$ that contains the curve a_i . Let us recall that for all $i \in \{0, 1, \dots, n-1\}$, the curve $\delta.a_i$ is a special curve of $\sigma_s(A_{i+1})$, so $\delta.a_i = a_{i+1}$. But $I(a_i, \delta.a_i) \neq 0$ according to Proposition 7.1 for a_i is special, so $I(a_i, a_{i+1}) \neq 0$, hence $\widehat{\Sigma}_i = \widehat{\Sigma}_{i+1}$. Thus all the special curves are included in a unique subsurface $\widehat{\Sigma}$ of $\text{Sub}_{\sigma_n(\mathcal{G}_0)}(\Sigma)$.

Let us show item (ii).

Let S be a subsurface belonging to $\text{Sub}_{\sigma_s(\mathcal{X})}(\widehat{\Sigma})$. If none of the boundary components of S is a normal curve, then S belongs to $\text{Sub}_{\sigma_s(\mathcal{X})}(\Sigma)$ and according to Proposition 9.3, the boundary of S contains $\sigma_s(\mathcal{X})$ and item (ii) is proved in this case.

Let us then assume that $\sigma_n(\mathcal{G}_0)$ is nonempty and let us focus on the surfaces of $\text{Sub}_{\sigma_s(\mathcal{X})}(\widehat{\Sigma})$ such that at least one of the boundary components is a normal curve. We define a subgroup \mathcal{H}^* of \mathcal{H} (\mathcal{H} was defined in Subsection 8.1) by:

$$\mathcal{H}^* := \langle \gamma_i \gamma_j^{-1}, i, j \in \text{Odd}(n) \rangle$$

It acts via ρ on $\text{Curv}(\Sigma)$ and notably on $\sigma(\mathcal{X})$ so that:

- *Action of \mathcal{H}^* via ρ on $\sigma_s(\mathcal{X})$.* We have seen that the action of \mathcal{H} via ρ on $\text{Curv}(\Sigma)$ preserves $\sigma_s(\mathcal{X})$, hence so does the action of \mathcal{H}^* on $\text{Curv}(\Sigma)$, since \mathcal{H}^* is included in \mathcal{H} . Moreover, the homomorphism $\mathcal{H} \rightarrow \mathfrak{S}(\mathcal{X})$ sends \mathcal{H}^* on $\mathfrak{A}(\mathcal{X})$, the alternating group on the elements of \mathcal{X} . Indeed, for all $i \in \text{Odd}(n)$, this homomorphism sends $\gamma_i \gamma_{i+2}^{-1}$ on the circular permutation on the three elements A_i, A_{i+2}, A_{i+4} . But $\mathfrak{A}(\mathcal{X})$ acts transitively on \mathcal{X} (recall that \mathcal{X} contains at least three elements). Hence the action of \mathcal{H}^* on $\mathcal{PMod}(\Sigma)$ preserves \mathcal{X} and is transitive on \mathcal{X} . Therefore \mathcal{H}^* acts transitively on $\sigma_s(\mathcal{X})$.
- *Action of \mathcal{H}^* via ρ on $\sigma_n(\mathcal{G}_0)$.* Let us recall that according to Proposition 7.14, the action of \mathcal{B}_n on $\sigma_n(\mathcal{G}_0)$ and on $\text{Bndy}(\Sigma_{\sigma_n(\mathcal{G}_0)})$ is cyclic. Then the action of $\mathcal{F}_n = \text{Ker}(\{\lambda : \mathcal{B}_n \rightarrow \mathbb{Z}, \tau_1 \mapsto 1\})$ on $\sigma_n(\mathcal{G}_0)$ and on $\text{Bndy}(\Sigma_{\sigma_n(\mathcal{G}_0)})$ is trivial according to Lemma 7.2.(iii). Since \mathcal{H}^* is a subgroup of \mathcal{F}_n , the action of \mathcal{H}^* on $\text{Curv}(\Sigma)$ fixes each curve of $\sigma_n(\mathcal{G}_0)$ and each boundary component of $\Sigma_{\sigma_n(\mathcal{G}_0)}$.
- *Action of \mathcal{H}^* via ρ on $\text{Sub}_{\sigma_n(\mathcal{G}_0)}(\widehat{\Sigma})$.* According to the action of \mathcal{H}^* on $\sigma_n(\mathcal{G}_0)$, the action of \mathcal{H}^* via ρ on $\text{Sub}(\Sigma)$ preserves $\widehat{\Sigma}$ and preserves the set $\text{Sub}_{\sigma_s(\mathcal{X})}(\widehat{\Sigma})$ of subsurfaces. Let S be a surface belonging to $\text{Sub}_{\sigma_s(\mathcal{X})}(\widehat{\Sigma})$ such that at least one of the boundary components is a normal curve. According to the action of \mathcal{H}^* via ρ on $\sigma_n(\mathcal{G}_0)$, the action of \mathcal{H}^* via ρ on $\text{Sub}(\Sigma)$ preserves the surface S .

Let us exploit this. For any subsurface S belonging to $\text{Sub}_{\sigma_s(\mathcal{X})}(\widehat{\Sigma})$ such that $\text{Bndy}(S)$ contains a normal curve, S must be stable by \mathcal{H}^* . Hence $\text{Bndy}(S)$ is \mathcal{H}^* -stable, and so is $\text{Bndy}(S) \cap \sigma_s(\mathcal{X})$. So $\text{Bndy}(S)$ must contain all $\sigma_s(\mathcal{X})$ since \mathcal{H}^* acts transitively on $\sigma_s(\mathcal{X})$.

Let us show items (iii) and (iv).

According to item (ii), each subsurface belonging to $\text{Sub}_{\sigma_s(\mathcal{X})}(\widehat{\Sigma})$ contains at least $\frac{n}{2}$ special curves in its boundary. Since $\sigma_s(\mathcal{X})$ contains $\frac{n}{2}$ curves, $\text{Sub}_{\sigma_s(\mathcal{X})}(\widehat{\Sigma})$ contains one only connected component having n special boundary components, or $\text{Sub}_{\sigma_s(\mathcal{X})}(\widehat{\Sigma})$ contains two connected components having each $\frac{n}{2}$ special boundary components. In the first case $\widehat{\Sigma}$ contains a non-separating set of $\frac{n}{2}$ curves, so $\widehat{\Sigma}$ is of genus $\widehat{g} \geq \frac{n}{2}$. In the second case $\widehat{\Sigma}$ contains a non-separating set of $\frac{n}{2} - 1$ curves, so $\widehat{\Sigma}$ is of genus $\widehat{g} \geq \frac{n}{2} - 1$. Let us recall that by hypothesis, $g \leq \frac{n}{2}$. Since Σ contains $\widehat{\Sigma}$, we have $\widehat{g} \leq g$. So finally, we have:

$$\frac{n}{2} - 1 \leq \widehat{g} \leq g \leq \frac{n}{2}$$

Let us show item (v).

We have just seen in items (iii) and (iv) that $\text{Sub}_{\sigma_s(\mathcal{X})}(\widehat{\Sigma})$ is a set of exactly one or two subsurfaces.

- If $\text{Sub}_{\sigma_s(\mathcal{X})}(\widehat{\Sigma})$ contains only one subsurface, let us denote it by S . The surface $\widehat{\Sigma}$ is the gluing of S on itself by making coincide the n boundary components between them. The difference between the genera of $\widehat{\Sigma}$ and S is then $\frac{n}{2}$, but $\widehat{\Sigma}$ is already of maximal genus $\frac{n}{2}$, so S is a genus-0 surface.
- If $\text{Sub}_{\sigma_s(\mathcal{X})}(\widehat{\Sigma})$ contains two subsurfaces, let us denote them by S_1 and S_2 . The gluing of S_1 on S_2 along the n special boundary components brings a contribution of $\frac{n}{2} - 1$ to the genus of $\widehat{\Sigma}$. Since the genus of $\widehat{\Sigma}$ is at most $\frac{n}{2}$, the sum of the genera of S_1 and of S_2 is at most 1.

□

Proposition 9.4 allows us to set the following definitions that will still be useful in Section 10. Actually, the full description of $\sigma_n(\mathcal{G}_0)$ is useless to prove Theorem 1. Focussing on the subset \mathcal{U} (defined just below) of $\sigma_n(\mathcal{G}_0)$ will be enough.

Definition 9.5 ($\widehat{\Sigma}$, $\check{\Sigma}$ and \mathcal{U}).

- Let $\widehat{\Sigma}$ be the subsurface of $\text{Sub}_{\sigma_n(\mathcal{G}_0)}(\Sigma)$ that contains the special curves.
- Let us set $\mathcal{U} = \text{Bndy}(\widehat{\Sigma}) \cap \sigma_n(\mathcal{G}_0)$.
- Let $\check{\Sigma}$ be the union of the subsurfaces of $\text{Sub}_{\mathcal{U}}(\Sigma)$ different from $\widehat{\Sigma}$. If $\widehat{\Sigma}$ is the only subsurface of $\text{Sub}_{\mathcal{U}}(\Sigma)$, we will say that $\check{\Sigma}$ is empty.

Attention: *Let us recall that we have supposed in this section that $\sigma_p(\mathcal{G}_0)$ was empty, in other words, the separating curves belonging to $\sigma_n(\mathcal{G}_0)$ separate Σ in two surfaces of nonzero genus. Without this hypothesis, Proposition 9.6 would be false.*

Remark. If $\check{\Sigma}$ is nonempty, we have $\text{Bndy}(\widehat{\Sigma}) \cap \text{Bndy}(\check{\Sigma}) = \mathcal{U}$. In the following section, the only information about $\sigma_n(\mathcal{G}_0)$ that will help us concerns \mathcal{U} . That is why we focus only on \mathcal{U} . According to this remark, the next proposition deals only with \mathcal{U} instead of $\sigma_n(\mathcal{G}_0)$. All the same, we terminates this section by giving all the possible graphs of $\Gamma(\Sigma, \sigma(\mathcal{X}))$.

Proposition 9.6 (Description of $\text{Sub}_{\mathcal{U}}(\Sigma)$).

We have $|\mathcal{U}| \leq 2$, and $\text{Sub}_{\mathcal{U}}(\Sigma)$ satisfies the following properties:

- if \mathcal{U} is empty, then $\Sigma = \widehat{\Sigma}$; if $\widehat{\Sigma}$ is of genus $\frac{n}{2}$, then \mathcal{U} is empty,
- if \mathcal{U} is reduced to a non-separating curve u , then $\check{\Sigma}$ is empty and $\{u\}$ is the mark of $\widehat{\Sigma}$,
- if \mathcal{U} is reduced to a separating curve u , then $\check{\Sigma}$ is a connected subsurface of genus 1,
- if \mathcal{U} contains two curves, then they are non-separating and $\check{\Sigma}$ is connected, of genus zero.

These assertions can be summed up as follows: the graph $\Gamma(\Sigma, \mathcal{U})$ is one of the four graphs depicted in Figure 34 where:

- the circled vertices represent the subsurfaces of nonzero genus of $\text{Sub}_{\mathcal{U}}(\Sigma)$,
- the integer placed beside the circled vertices indicates the genus.

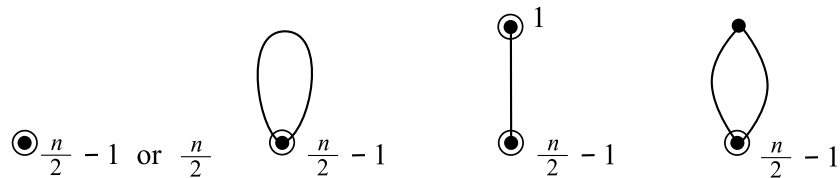

Figure 34: The four possible graphs for $\Gamma(\Sigma, \mathcal{U})$ (cf. Proposition 9.6).

Proof. The proof comes from a genus computation. Let us recall that g is the genus of Σ . Let us denote by \widehat{g} the genus of $\widehat{\Sigma}$ and by \check{g} the genus of $\check{\Sigma}$ (which is zero by convention when $\check{\Sigma}$ is empty). According to Proposition 9.4, we have:

$$g \in \{\frac{n}{2} - 1, \frac{n}{2}\}, \quad \widehat{g} \in \{\frac{n}{2} - 1, \frac{n}{2}\}, \quad \check{g} \in \{0, 1\}.$$

Notice that each (nonempty) connected component of $\check{\Sigma}$, that is separated from $\widehat{\Sigma}$ by a separating curve of \mathcal{U} , is of nonzero genus, for we have assumed that there exists no peripheral curve in $\sigma(\mathcal{G}_0)$. Hence it can exist only one nonempty connected component of $\check{\Sigma}$ separated from $\widehat{\Sigma}$ by a separating curve. Besides, if a (nonempty) connected component of $\check{\Sigma}$ is of genus zero, it is separated from $\widehat{\Sigma}$ by at least two curves of \mathcal{U} (again because the curves of \mathcal{U} are not peripheral curves). So the gluing of $\widehat{\Sigma}$ and of a genus-0 connected component of $\check{\Sigma}$ brings also a nonzero contribution to the genus of Σ . Hence $\check{\Sigma}$ contains only one connected component. In other words, $\check{\Sigma}$ is connected. Hence the following formula holds as soon as $\check{\Sigma}$ is nonempty:

$$g - \widehat{g} - \check{g} = |\mathcal{U}| - 1.$$

This number must be equal to zero or one. Hence $|\mathcal{U}| \in \{1, 2\}$ (still under the hypothesis: $\check{\Sigma}$ is nonempty). If $|\mathcal{U}| = 2$, then $\check{g} = 0$. We have seen that conversely, if $\check{g} = 0$ whereas $\check{\Sigma}$ is nonempty, we have $|\mathcal{U}| \geq 2$, so $|\mathcal{U}| = 2$. Similarly, if $\check{\Sigma}$ is nonempty, $|\mathcal{U}| = 1$ if and only if $\check{g} = 1$. These two last cases correspond to the two graphs drawn in Figure 34, right-hand side. When $\check{\Sigma}$ is empty, we get obviously the two graphs in Figure 34, left-hand side. \square

10 Expression of the mapping classes of \mathcal{G}_0

Hypotheses.

Let $n \geq 6$ an even number, let $\Sigma = \Sigma_{g,b}$ with $g \leq \frac{n}{2}$, and let $\rho : \mathcal{B}_n \rightarrow \mathcal{PMod}(\Sigma)$ such that:

- ρ is non-cyclic by assumption,
- $\sigma_p(\mathcal{G}_0) = \emptyset$ by assumption, inspired by Proposition 4.7,
- $\sigma_s(A_i) = \{a_i\}$ according to 9.3
- a_i is not separating according to Proposition 8.1

We want to show that ρ is a transvection of monodromy homomorphism. To do so, we first show in Subsection 10.1 that ρ induces on $\widehat{\Sigma}$ (cf. Definition 9.5) a transvection of monodromy homomorphism. Then we show in Subsection 10.2 that ρ is itself a transvection of monodromy homomorphism. Finally, in Subsections 10.3 and 10.4, we show Theorem 1 when n is even and when n is odd, respectively.

10.1 The homomorphism $\widehat{\rho}$ induced by ρ on $\mathcal{Mod}(\widehat{\Sigma})$

We then define the homomorphism

$$\wedge : \begin{array}{ccc} \mathcal{PMod}_{\sigma_n(\mathcal{G}_0)}(\Sigma) & \longrightarrow & \mathcal{Mod}(\widehat{\Sigma}) \\ A & \longmapsto & \widehat{A} \end{array} .$$

We denote by $\widehat{\rho}$ the composition $\wedge \circ \rho : \mathcal{B}_n \rightarrow \mathcal{Mod}(\widehat{\Sigma})$. This homomorphism is well-defined for $\rho(\mathcal{B}_n)$ preserves $\sigma_n(\mathcal{G}_0)$ according to Proposition 7.14. We will prove in this subsection that $\widehat{\rho}$ is a transvection of monodromy homomorphism.

We denote by $\widehat{\mathcal{G}}_0$ and $\widehat{\mathcal{X}}$ the images of \mathcal{G}_0 and \mathcal{X} by \wedge , where $\mathcal{X} = \{A_i, i \in \text{Odd}(n)\} = \{A_1, A_3, \dots, A_{n-1}\}$. In order to study the homomorphism $\widehat{\rho}$, we focus on the mapping classes induced by those belonging to $\widehat{\mathcal{X}}$, in $\text{Mod}(\widetilde{\Sigma})$, where $\widetilde{\Sigma}$ is the surface $\widehat{\Sigma}_{\sigma_s(\widehat{\mathcal{X}})}$. Notice that, according to Lemma A.20, we have:

$$\begin{cases} \sigma_s(\widehat{\mathcal{X}}) = \sigma_s(\mathcal{X}) \cap \mathcal{C}\text{urv}(\widehat{\Sigma}) = \{a_i, i \in \text{Odd}(n)\}, \\ \sigma_n(\widehat{\mathcal{X}}) = \sigma_n(\mathcal{X}) \cap \mathcal{C}\text{urv}(\widehat{\Sigma}) = \emptyset. \end{cases}$$

Cutting $\widehat{\Sigma}$ along the curves of $\sigma_s(\widehat{\mathcal{X}})$

- Let $\widetilde{\Sigma}$ be the surface $\widehat{\Sigma}_{\sigma_s(\widehat{\mathcal{X}})}$. According to Proposition 9.4.(v), $\widetilde{\Sigma}$ is a connected genus-0 surface, or contains two connected components such that one is of genus zero and the other is of genus at most one.
- Let \sim be the canonical homomorphism $\sim: \text{Mod}_{\widehat{A}}^{\sigma_s(\widehat{\mathcal{X}})}(\widehat{\Sigma}) \rightarrow \text{Mod}(\widetilde{\Sigma})$, where $\text{Mod}_{\widehat{A}}^{\sigma_s(\widehat{\mathcal{X}})}(\widehat{\Sigma})$ is the group of the mapping classes of $\text{Mod}(\widehat{\Sigma})$ preserving $\sigma_s(\widehat{\mathcal{X}})$. We will denote by $\widetilde{\mathcal{X}}$ the image of $\widehat{\mathcal{X}}$.
- For all $i \in \text{Odd}(n)$, let us denote by a_i^+ and a_i^- the two boundary components coming from cutting $\widehat{\Sigma}$ along a_i . We set $\text{Bndy}^+(\widetilde{\Sigma}) = \{a_i^+, i \in \text{Odd}(n)\}$ and $\text{Bndy}^-(\widetilde{\Sigma}) = \{a_i^-, i \in \text{Odd}(n)\}$. When $\widetilde{\Sigma}$ is not connected, the boundary components a_i^+ and a_i^- are such that $\text{Bndy}^+(\widetilde{\Sigma})$ is included in the boundary of one connected components of $\widetilde{\Sigma}$ and $\text{Bndy}^-(\widetilde{\Sigma})$ is included in the boundary of the other connected components of $\widetilde{\Sigma}$. For these definitions, see Figure 35 that represents the case where $\widetilde{\Sigma}$ is connected.

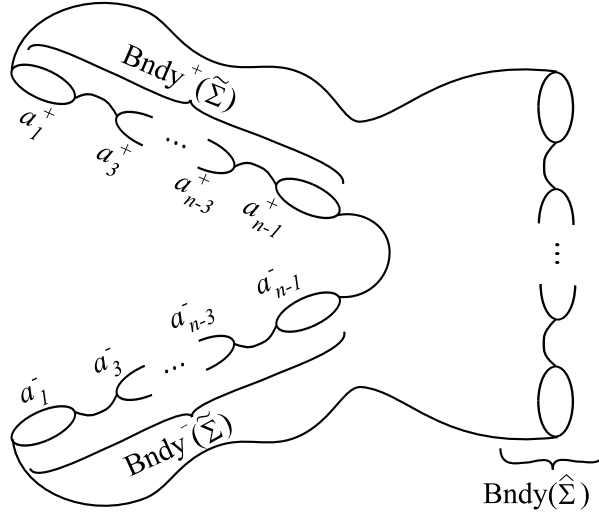

Figure 35: The surface $\widetilde{\Sigma}$ (case where $\widetilde{\Sigma}$ is connected).

- Recall that the subgroup \mathcal{H} of \mathcal{B}_n (see Subsection 8.1) is the subgroup $\langle \gamma_i, i \in \text{Odd}(n) \rangle$ of \mathcal{B}_n where for all $i \in \text{Odd}(n)$, the element γ_i is the product $\tau_i \tau_{i+1} \tau_i \tau_{i+2} \tau_{i+1} \tau_i$.
- Let us also recall the main properties of \mathcal{H} (see Proposition 8.2):

(i) The action of \mathcal{H} on $\mathcal{PMod}(\Sigma)$ via ρ preserves \mathcal{X} . Indeed, for all $i, j \in \text{Odd}(n)$, we have:

$$\gamma_i \cdot A_j = \rho(\gamma_i) A_j \rho(\gamma_i)^{-1} = \begin{cases} A_j & \text{if } i \notin \{j, j-2\} \\ A_{j-2} & \text{if } i = j-2 \\ A_{j+2} & \text{if } i = j. \end{cases}$$

(ii) The homomorphism $\mathcal{H} \rightarrow \mathfrak{S}(\mathcal{X})$ describing the action of \mathcal{H} on \mathcal{X} , where $\mathfrak{S}(\mathcal{X})$ is the symmetric group on the elements of \mathcal{X} , is surjective. In particular, this action is $\frac{n}{2}$ times transitive.

(iii) The action of \mathcal{H} on $\mathcal{C}urv(\Sigma)$ preserves $\sigma_s(\mathcal{X})$.

- For all $\xi \in \mathcal{H}$, the mapping class $\rho(\xi)$ preserves $\sigma_s(\mathcal{X})$, so the element $\sim \circ \wedge (\rho(\xi))$ is well-defined. Thus, we can define an action of \mathcal{H} on $\tilde{\mathcal{X}}$ as follows. For all $\xi \in \mathcal{H}$ and all $A \in \mathcal{X}$, we set:

$$\xi \cdot \tilde{A} = \sim \circ \wedge (\rho(\xi) A \rho(\xi)^{-1}).$$

Notice that the action of \mathcal{H} on $\tilde{\mathcal{X}}$ can be deduced from the action of \mathcal{H} on \mathcal{X} . Then, for all $i, j \in \text{Odd}(n)$, we have:

$$\gamma_i \cdot \tilde{A}_j = \begin{cases} \tilde{A}_j & \text{if } i \notin \{j, j-2\} \\ \tilde{A}_{j-2} & \text{if } i = j-2 \\ \tilde{A}_{j+2} & \text{if } i = j. \end{cases}$$

Lemma 10.1 (The mapping classes \tilde{A}_i , $i \in \text{Odd}(n)$).

All the mapping classes \tilde{A}_i , $i \in \text{Odd}(n)$, coincide. Either they are trivial, or there are periodic of order 2 and swap a_j^+ and a_j^- for all $j \in \text{Odd}(n)$.

Proof.

Action of \mathcal{H} on $\text{Bndy}^+(\tilde{\Sigma}) \sqcup \text{Bndy}^-(\tilde{\Sigma})$:

Notice that each mapping class of $\tilde{\mathcal{X}}$ preserves $\sigma_s(\tilde{A}_i)$ for all $i \in \text{Odd}(n)$, so each mapping class of $\tilde{\mathcal{X}}$ preserves $\{a_i^+, a_i^-\}$ for all $i \in \text{Odd}(n)$. If \tilde{A}_1 fixes both boundary components a_3^+ and a_3^- , then \tilde{A}_1 fixes both boundary components a_i^+ and a_i^- for all $i \in \text{Odd}(n) \setminus \{1\}$, as we are going to show it right now. Let us recall that according to Proposition 8.2, \mathcal{H} acts $\frac{n}{2}$ times transitively on \mathcal{X} , hence on $\tilde{\mathcal{X}}$. So, for all $i \in \text{Odd}(n) \setminus \{1\}$, there exists $\xi \in \mathcal{H}$ such that $\xi \cdot \tilde{A}_1 = \tilde{A}_i$ and $\xi \cdot \tilde{A}_3 = \tilde{A}_i$. Then if \tilde{A}_1 fixes the boundary components a_3^+ and a_3^- , $\xi \cdot \tilde{A}_1$ fixes the boundary components $\xi \cdot a_3^+$ and $\xi \cdot a_3^-$ (\mathcal{H} acts canonically via ρ on $\text{Bndy}(\tilde{\Sigma})$), so \tilde{A}_i fixes both boundary components a_i^+ and a_i^- . So there exist *a priori* four possible actions of $\tilde{\mathcal{X}}$ on $\text{Bndy}^+(\tilde{\Sigma}) \sqcup \text{Bndy}^-(\tilde{\Sigma})$:

- the mapping classes of $\tilde{\mathcal{X}}$ fixes the curves of $\text{Bndy}^+(\tilde{\Sigma}) \sqcup \text{Bndy}^-(\tilde{\Sigma})$;
- the mapping classes of $\tilde{\mathcal{X}}$ swap a_i^+ and a_i^- for all $i \in \text{Odd}(n)$;
- for all $i \in \text{Odd}(n)$, \tilde{A}_i swaps a_i^+ and a_i^- , and fixes a_j^+ and a_j^- for all $j \in \text{Odd}(n) \setminus \{i\}$;

d) for all $i \in \text{Odd}(n)$, \tilde{A}_i fixes a_i^+ and a_i^- , and swaps a_j^+ and a_j^- for all $j \in \text{Odd}(n) \setminus \{i\}$.

Both cases a) and b) correspond to the situations described in the statement of Lemma 10.1. In the remainder of this proof, we assume to be in the case c) or d) and we expect to find some contradiction. Let us show first the below assertion (1), stating that $\tilde{\Sigma}$ must be connected. Notice that in the cases c) and d), \tilde{A}_1 sends some boundary components of $\text{Bndy}^+(\tilde{\Sigma})$ in $\text{Bndy}^+(\tilde{\Sigma})$ and some other boundary components of $\text{Bndy}^+(\tilde{\Sigma})$ in $\text{Bndy}^-(\tilde{\Sigma})$. Yet, on one hand the boundary components of $\text{Bndy}^+(\tilde{\Sigma})$ belong to a same connected component of $\tilde{\Sigma}$ and so do the boundary components of $\text{Bndy}^-(\tilde{\Sigma})$. On the other hand, \tilde{A}_1 sends the connected components of $\tilde{\Sigma}$ on the connected components of $\tilde{\Sigma}$. Hence there exists a connected component in $\tilde{\Sigma}$ that contains some boundary components of $\text{Bndy}^+(\tilde{\Sigma})$ and some other boundary components of $\text{Bndy}^-(\tilde{\Sigma})$. By a transitivity argument, the boundary components of $\text{Bndy}^+(\tilde{\Sigma})$ and of $\text{Bndy}^-(\tilde{\Sigma})$ belong to a same connected component, hence:

$$\text{the surface } \tilde{\Sigma} \text{ is connected.} \quad (1)$$

We pursue the proof of Lemma 10.1 by studying the nature of the mapping classes of $\tilde{\mathcal{X}}$, (reducible, periodic or pseudo-Anosov). We will show that they are periodic and we will determine their order.

The nature of the mapping classes of $\tilde{\mathcal{X}}$:

The mapping class \tilde{A}_1 is pseudo-Anosov or periodic, for $\sigma(\tilde{A}_1) = \emptyset$. Remember that $\tilde{\Sigma}$ is the cut of $\hat{\Sigma}$ along the curves $\sigma_s(\hat{X})$. So, if \tilde{A}_1 was pseudo-Anosov in $\text{Mod}(\tilde{\Sigma})$, the mapping class \hat{A}_1 in $\text{Mod}(\hat{\Sigma})$ would satisfy $\sigma(\hat{A}_1) = \sigma_s(\hat{X})$, according to Lemma A.21. However $\sigma_s(\hat{A}_1) = \{a_1\}$, whence a contradiction. So \tilde{A}_1 is periodic. Now, notice that \tilde{A}_1^2 fixes each curve of $\text{Bndy}^+(\tilde{\Sigma}) \sqcup \text{Bndy}^-(\tilde{\Sigma})$, so \tilde{A}_1^2 is a periodic mapping class that fixes more than three boundary components in a genus-0 surface. Hence, according to Corollary A.9, \tilde{A}_1^2 is the identity. Hence \tilde{A}_1 is the identity or is periodic of order two. The same argument can be held for \tilde{A}_i for all $i \in \text{Odd}(n)$. Hence:

$$\begin{aligned} &\text{either the mapping classes of } \tilde{\mathcal{X}} \text{ all are the identity,} \\ &\text{or they all are periodic of order two.} \end{aligned} \quad (2)$$

We are now ready to focus on the case c) and then on the case d), in order to find some contradiction.

Refutation of the case c):

In the case c), \tilde{A}_1 fixes at least $n - 2$ boundary components of $\tilde{\Sigma}$. But as we saw it in (1), $\tilde{\Sigma}$ is a connected genus-0 surface. Furthermore, \tilde{A}_1 is periodic according to (2), so we can apply Corollary A.9 and conclude that \tilde{A}_1 is the identity. But then \tilde{A}_1 must fix a_1^+ and a_1^- , which contradicts the hypotheses of the case c).

Study and refutation of the case d):

A following simple argument allows us to reject the case d) when $n \geq 8$. Let us consider the mapping class $\tilde{A}_1\tilde{A}_3$. It is periodic of order 2, for \tilde{A}_1 and \tilde{A}_3 commute. According to Corollary A.9, a periodic mapping class that fixes three or more boundary components of a genus-0 surface is the identity. Here, $\tilde{A}_1\tilde{A}_3$ fixes all the special boundary components except the boundary components a_1^+ , a_1^- , a_3^+ and a_3^- . So, when $n \geq 8$, the mapping class $\tilde{A}_1\tilde{A}_3$ fixes at least four boundary components. Then $\tilde{A}_1\tilde{A}_3$ must be the identity. But this is absurd, for

$\tilde{A}_1\tilde{A}_3$ does not fix the boundary components a_1^+ , a_1^- , a_3^+ and a_3^- . Hence the case d) can *a priori* happen only if $n = 6$.

Let us consider the case $n = 6$ and let us describe the situation. Recall that according to (1), $\tilde{\Sigma}$ is connected. Let $\text{Bndy}^0(\tilde{\Sigma})$ be the set of boundary components of $\tilde{\Sigma}$ that do not belong to $\text{Bndy}^+(\tilde{\Sigma}) \sqcup \text{Bndy}^-(\tilde{\Sigma})$. Again, the mapping class $\tilde{A}_1\tilde{A}_3$ is periodic and fixes the boundary components a_5^+ , a_5^- , whereas it permutes the boundary components a_1^+ , a_1^- , a_3^+ and a_3^- non-trivially. According to Corollary A.9, such a mapping class fixes at most two boundary components. Hence $\tilde{A}_1\tilde{A}_3$ fixes no boundary component of $\text{Bndy}^0(\tilde{\Sigma})$. Yet, on one hand, $\text{Bndy}^0(\tilde{\Sigma})$ is included in $\text{Bndy}(\Sigma) \cup \mathcal{U}$, and on the other hand the mapping classes of $\tilde{\mathcal{X}}$ fixes the curves of $\text{Bndy}(\Sigma) \cap \text{Bndy}^0(\tilde{\Sigma})$ and have all the same action on the curves of $\mathcal{U} \cap \text{Bndy}^0(\tilde{\Sigma})$. So $\text{Bndy}(\Sigma) \cap \text{Bndy}^0(\tilde{\Sigma})$ must be empty. Concerning \mathcal{U} , notice that in each of the three cases $|\mathcal{U}| \in \{0, 1, 2\}$ which are authorized by Proposition 9.6, the mapping class $\tilde{A}_1\tilde{A}_3$ fixes the curves of \mathcal{U} . Thus $\mathcal{U} \cap \text{Bndy}^0(\tilde{\Sigma})$ and $\text{Bndy}(\Sigma) \cap \text{Bndy}^0(\tilde{\Sigma})$ are finally empty sets. Hence \mathcal{U} , $\text{Bndy}(\Sigma)$ and $\text{Bndy}^0(\tilde{\Sigma})$ are all empty sets. Hence:

$$\hat{\Sigma} = \Sigma = \Sigma_{3,0}, \text{ and } \tilde{\Sigma} = \Sigma_{0,6}.$$

We have represented the surface $\tilde{\Sigma}$ in Figure 36 and we have described in it an example of an *a priori* possible set of the three periodic mapping classes \tilde{A}_1 , \tilde{A}_3 , and \tilde{A}_5 , such that their action on $\text{Bndy}(\tilde{\Sigma})$ is coherent with the case d).

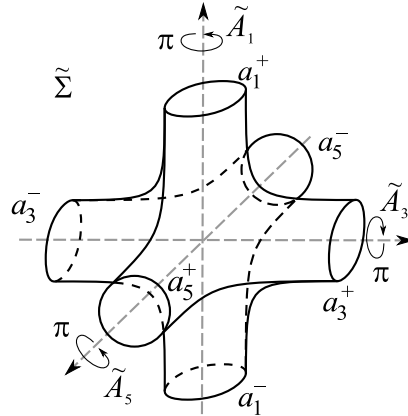

Figure 36: The case $n = 6$ where \tilde{A}_1 fixes a_1^+ and a_1^- , and permute a_3^+ with a_3^- , and a_5^+ with a_5^- . We see $\tilde{\Sigma}$ in \mathbb{R}^3 and the mapping classes \tilde{A}_1 , \tilde{A}_3 and \tilde{A}_5 are isotopy classes of rotations.

Now, since \mathcal{U} is empty (and hence since $\sigma_n(\mathcal{G}_0)$ is empty), the homomorphism \wedge is trivial so we can forget it. The contradiction we aim will comes from a study on the mapping class $Z = (A_3A_4A_5)^2$: we will see that it induces on a subsurface of Σ a periodic mapping class of order 4 and that the square of Z coincides with A_1 modulo a power of Dehn twist along the curve a_1 . But as we will see it, such a mapping class has no square root. This is absurd since Z is a square itself.

1. *First attempt to describe $\sigma(Z)$.*

Let us recall that $\sigma(Z) = \sigma(Z^2)$. Since A_1 commutes with A_1 , A_3 , A_4 and A_5 , the mapping classes Z and A_1 commute. Hence Z fixes the curve a_1 . Moreover, $ZA_3Z^{-1} = A_5$ and $ZA_5Z^{-1} = A_3$, so Z swaps the curves a_3 and a_5 . Hence Z induces a mapping class \tilde{Z} in $\text{Mod}(\tilde{\Sigma})$. Moreover,

let us justify that Z^2 commutes with A_3, A_4 and A_5 . In \mathcal{B}_4 , the element $\delta = \tau_1\tau_2\tau_3$ acts cyclically on the set $\{\tau_1, \tau_2, \tau_3, \tau_0\}$ by conjugation, so $(\tau_1\tau_2\tau_3)^4$ acts trivially on this set by conjugation. Now, the fact that Z^2 commutes with A_3, A_4 and A_5 comes from an obvious homomorphism from \mathcal{B}_4 to $\langle A_3, A_4, A_5 \rangle$ that sends τ_1, τ_2 and τ_3 respectively on A_3, A_4 and A_5 , and that sends $(\tau_1\tau_2\tau_3)^4$ on Z^2 . Hence:

$$Z^2 \text{ commutes with } A_1, A_3, A_4, A_5. \quad (3)$$

So,

$$Z^2 \text{ fixes the curves } a_1, a_3, a_4 \text{ and } a_5. \quad (4)$$

Hence the curves a_1, a_3, a_4, a_5 are some reduction curves of Z^2 , so we have $I(\sigma(Z^2), \{a_1, a_3, a_4, a_5\}) = 0$. Hence, if we see $\tilde{\Sigma}$ as a subsurface of Σ , we have:

$$\sigma(Z^2) \subset \mathcal{C}\text{urv}(\tilde{\Sigma}) \cup \{a_1, a_3, a_5\}. \quad (5)$$

But a_4 , which is a reduction curve of Z^2 , intersects a_3 and a_5 , so neither a_3 nor a_5 can belong to $\sigma(Z^2)$. So (5) can be replaced by (6):

$$\sigma(Z^2) \subset \mathcal{C}\text{urv}(\tilde{\Sigma}) \cup \{a_1\}. \quad (6)$$

We are interested in $\sigma(Z)$ which is equal to $\sigma(Z^2)$. According to (6), we should investigate the set $\sigma(Z) \cap \mathcal{C}\text{urv}(\tilde{\Sigma})$. To do so, we focus on \tilde{Z} , which we define as being $\sim (Z)$, the induced mapping class by Z in $\text{Mod}(\tilde{\Sigma})$. Notice that $\sim (Z)$ is well-defined, since Z preserves the set $\{a_1, a_3, a_5\}$. According to Lemma A.20, we have:

$$\sigma(\tilde{Z}) = \sigma(Z) \cap \mathcal{C}\text{urv}(\tilde{\Sigma}). \quad (7)$$

Let us then describe the surface $\tilde{\Sigma}_{\sigma(\tilde{Z})}$. In the remainder of step 1., we refer to Figure 37.

- (i) Since a_4 intersects a_3 and a_5 but does not intersect the curves of $\sigma(Z)$, there exists in $\tilde{\Sigma}_{\sigma(\tilde{Z})}$ a path ω included in a_4 such that ω has one of its extremities in $a_3^+ \cup a_3^-$ and the other extremity in $a_5^+ \cup a_5^-$. Even if it means renaming the curves, we can assume that this path is with extremities in a_3^+ and a_5^+ . So we can assume without loss of generality that a_3^+ and a_5^+ belong to a same connected component of $\tilde{\Sigma}_{\sigma(\tilde{Z})}$. Let us denote this connected component by C^+ .
- (ii) Since A_1 commutes with Z^2 according to (3), it preserves the curves of $\sigma(Z)$ and induces an action on the boundary components of $\tilde{\Sigma}_{\sigma(\tilde{Z})}$. According to the hypotheses of the case d), \tilde{A}_1 sends a_3^+ and a_5^+ respectively on a_3^- and a_5^- . So \tilde{A}_1 sends ω on a path joining a_3^- and a_5^- . Therefore a_3^- and a_5^- belong to a same connected component of $\tilde{\Sigma}_{\sigma(\tilde{Z})}$. Let us denote this connected component by C^- .
- (iii) Since A_3 commutes with Z^2 according to (3), it preserves the curves of $\sigma(Z)$ and induces an action on the boundary components of $\tilde{\Sigma}_{\sigma(\tilde{Z})}$. According to the hypotheses of the case d), \tilde{A}_3 sends a_3^+ and a_5^+ respectively on a_3^+ and a_5^- . So \tilde{A}_3 sends ω on a path joining a_3^+ and a_5^- . Therefore a_3^+ and a_5^- belong to a same connected component of $\tilde{\Sigma}_{\sigma(\tilde{Z})}$. So $C^+ = C^-$. Let us denote by C this connected component.

2. We show that the set $\sigma(Z)$ is included in $\{a_1\}$.

We argue by contradiction. Let us assume that there exists a curve x in $\sigma(Z)$ different from a_1 . According to (6), the curve x lies in $\sigma(\tilde{Z})$. It is a separating curve of $\tilde{\Sigma}$ for $\tilde{\Sigma}$ is a genus-0

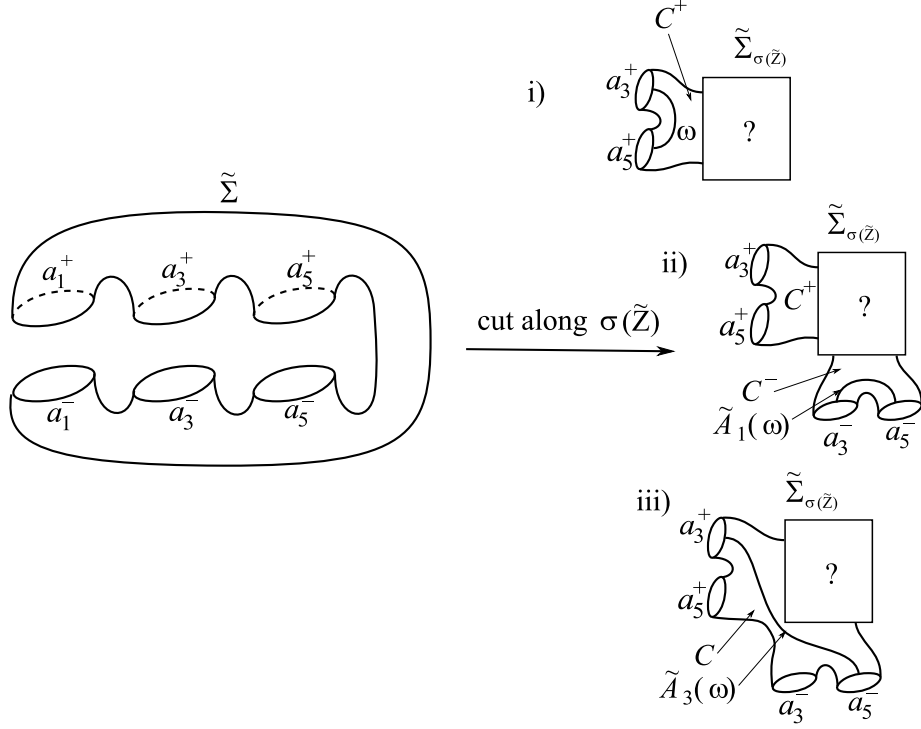

Figure 37: Following the argument of step 1. of the proof of Lemma 10.1.

surface. Let x^+ and x^- be the two boundary components of $\tilde{\Sigma}_{\sigma(\tilde{Z})}$ coming from the cut along x . We can assume that x^- is a boundary component of C whereas x^+ belongs to another connected component of $\tilde{\Sigma}_{\sigma(\tilde{Z})}$ that we call P . Notice that $\chi(\tilde{\Sigma}_{\sigma(\tilde{Z})}) = \chi(\tilde{\Sigma}) = -4$, whereas $\chi(C) \leq -3$ since it has at least five boundary components: $a_3^+, a_3^-, a_5^+, a_5^-$ and x^- , and $\chi(P) \leq -1$. Since $-4 = -3 - 1$, the connected component C is a sphere with five holes, P is a sphere with three holes, and C and P are the only connected components of $\tilde{\Sigma}_{\sigma(\tilde{Z})}$. So

$$x \text{ is the only curve in } \sigma(\tilde{Z}). \quad (8)$$

Notice that $\text{Bndy}(P)$ is equal to $\{x^+, a_1^+, a_1^-\}$. This situation is summed up in Figure 38.

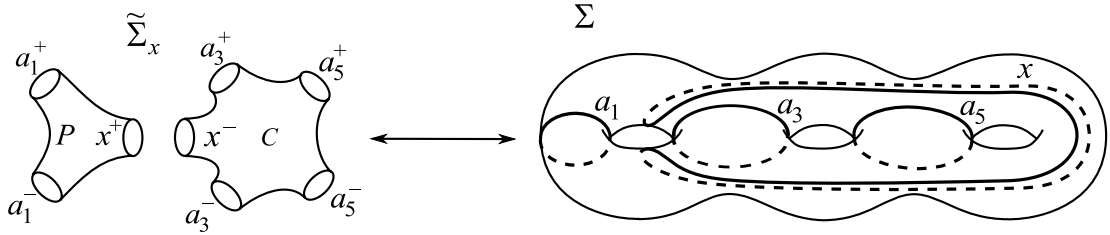

Figure 38: The curve x such that $\sigma(\tilde{Z}) = \{x\}$.

Now, \tilde{A}_3 commutes with \tilde{Z}^2 , so \tilde{A}_3 fixes the curve x . Then \tilde{A}_3 induces a mapping class in $\text{Mod}(\tilde{\Sigma}_x)$. But $\tilde{\Sigma}_x$ contains two non-homeomorphic connected components, so \tilde{A}_3 induces a mapping class on each connected component. Let F be the so induced mapping class by \tilde{A}_3 on C . It is periodic of order two on the surface C (for \tilde{A}_3 was periodic of order two, according

to (2)). However, F fixes x^- , a_3^+ and a_3^- . This is in contradiction with Corollary A.9, since C is a genus-0 surface, and any periodic mapping class on a genus-0 surface that fixes three boundary components is the identity. This is the expected contradiction. We have then shown that $\sigma(Z) \subset \{a_1\}$.

3. Let us show that Z^2 and A_1 coincide, up to a power of a Dehn twist along the curve a_1 .

Let us recall that, according to (2), \tilde{A}_1 is periodic of order two. The mapping class \tilde{Z} satisfies $\sigma(\tilde{Z}) = \emptyset$, so it is either pseudo-Anosov, or periodic. If it was pseudo-Anosov, the curves a_1 , a_3 and a_5 would be essential reduction curves of Z , but we saw in step 1. that a_3 and a_5 were not. Hence \tilde{Z} is periodic. Then the mapping classes \tilde{Z} and \tilde{A}_1 are periodic and commute, so they span a finite group. Notice that according to the hypotheses of the case d), \tilde{A}_1 fixes the curves a_1^+ and a_1^- . Concerning \tilde{Z} , remember that A_3 , A_4 and A_5 fix the curve a_1 , hence so does the mapping class $A_3A_4A_5$. So the mapping class $Z = (A_3A_4A_5)^2$ fixes the curve a_1 and does not permute the two connected components of $\mathcal{V} \setminus a_1$ where \mathcal{V} is a tubular neighbourhood of a_1 , so \tilde{Z} fixes the curves a_1^+ and a_1^- . Hence \tilde{Z} and \tilde{A}_1 are periodic mapping classes and both fix the curves a_1^+ and a_1^- , so according to Lemma A.16, \tilde{Z} and \tilde{A}_1 span a cyclic group. Since the order of \tilde{Z} is even (for \tilde{Z} swaps $\{a_3^+, a_3^-\}$ with $\{a_5^+, a_5^-\}$) and since the order of \tilde{A}_1 is two, then there exists an integer $k \geq 1$ such that $\tilde{A}_1 = \tilde{Z}^k$. But \tilde{Z}^4 has a trivial action on the boundary components of $\tilde{\Sigma}$, so it is the identity, hence $k \in \{1, 2, 3\}$. But \tilde{Z} and \tilde{Z}^3 swap $\{a_3^+, a_3^-\}$ and $\{a_5^+, a_5^-\}$ whereas \tilde{A}_1 preserves each of these sets, so $k \notin \{1, 3\}$. Finally,

$$\tilde{A}_1 = \tilde{Z}^2.$$

Let us consider the product $Z^2A_1^{-1}$. We just have seen that $\sim(Z^2A_1^{-1})$ is trivial in $\mathcal{M}\text{od}(\tilde{\Sigma})$, so according to the following exact sequence:

$$1 \rightarrow \langle T_{a_1}, T_{a_3}, T_{a_5} \rangle \rightarrow \mathcal{M}\text{od}_{\sigma_s(\mathcal{X})}(\Sigma) \xrightarrow{\sim} \mathcal{M}\text{od}(\tilde{\Sigma}) \rightarrow 1,$$

the mapping class $Z^2A_1^{-1}$ is a multitwist along the curves a_1 , a_3 and a_5 . But $\sigma(A_1)$ is equal to $\{a_1\}$ and according to step 2., $\sigma(Z^2)$ is included in $\{a_1\}$, so according to Proposition ??.(v), $\sigma(Z^2A_1^{-1})$ is included in $\{a_1\}$.

3. We get a contradiction when we examine on the mapping class $Y = A_3A_4A_5$.

We can see $\tilde{\Sigma}$ as a punctured sphere where each boundary component has been replaced by a puncture. The mapping class \tilde{Z} of $\mathcal{M}\text{od}(\tilde{\Sigma})$ is periodic so according to Kerckhoff's Theorem, \tilde{Z} can be represented by a periodic diffeomorphism of $\tilde{\Sigma}$. According to Kerkjartò's Theorem, this periodic diffeomorphism is conjugate to a rotation on the sphere $\tilde{\Sigma}$ by a diffeomorphism isotopic to the identity. Since \tilde{Z} is of order 4, $\tilde{\Sigma}$ is the isotopy class of an angle $\pm\pi/2$ rotation over an axis containing two punctures that correspond to the boundary components a_1^+ and a_1^- . The square of this rotation is in the isotopy class of \tilde{A}_1 . This justifies Figure 39 in which we have represented the genus-2 surface Σ_{a_1} with two boundary components a_1^+ and a_1^- , and the periodic mapping classes A'_1 and Z' induced by A_1 and Z in $\mathcal{P}\mathcal{M}\text{od}(\Sigma_{a_1})$. We can see that A'_1 has exactly four fixed points, namely P_1, P_2, P_3 and P_4 , in Figure 39. Therefore:

- (1) Z' has no fixed points,
- (2) $Z'^2 = A'_1$ has four fixed points.

Let us set $Y := A_3A_4A_5$. According to Proposition 7.13, A_3 , A_4 and A_5 fix $\sigma_s(A_1)$, hence fix a_1 . So Y induces a mapping class in $\mathcal{M}\text{od}(\Sigma_{a_1})$, which we will call Y' . Since Z' is periodic of order 4, the mapping class Y' is periodic of order 8. Assertions (1) and (2) imply assertions (3)-(5) below. Only assertion (5) needs to be proved.

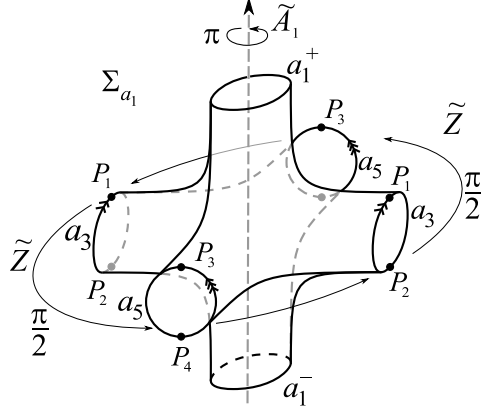

Figure 39: The periodic mapping class \tilde{A}_1 induced by A_1 in Σ_{a_1} (the arrows along the curves a_3 and a_5 stand for a gluing along these curves, so that Σ_{a_1} is indeed a genus-2 surface with two boundary components: a_1^+ and a_1^-).

- (3) Y' is periodic of order 8 without fixed points,
- (4) $Y'^2 = Z'$ is periodic of order 4 without fixed points,
- (5) Y'^4 has four fixed points belonging to a same orbit under Y' .

Let us justify assertion (5). If Y' preserved $\{P_1, P_3\}$, then Y'^2 would fix P_1 and P_3 . But it does not, so the cardinality of the orbit of P_1 under Y' is at least 4. But Y'^2 preserves $\{P_1, P_3\}$, so the cardinality of the orbit of P_1 under Y' is at most 4. Hence the orbit of P_1 and P_3 and the orbit of P_2 and of P_4 contain exactly 4 points. Since Y'^4 contains 4 fixed points instead of 8, the orbit of P_1 and the orbit of P_2 coincide. Thus assertion (5) is proved. We are then ready to apply Lemma A.7, linking the Euler characteristics of Σ_{a_1} and of the quotient surface $\Sigma_{a_1}/\langle Y' \rangle$. To do this, let us compute $\chi(\Sigma_{a_1}/\langle Y' \rangle)$. The mapping classes A'_3, A'_4 and A'_5 induced by A_3, A_4 and A_5 in $\text{Mod}(\Sigma_{a_1})$ swap a_1^+ and a_1^- (we knew it already for A_3 and A_5 by hypothesis, we deduce it easily for A_4). So Y' swaps a_1^+ and a_1^- , so the surface $\Sigma_{a_1}/\langle Y' \rangle$ must have a unique boundary component. Since Y' preserves the orientation, $\Sigma_{a_1}/\langle Y' \rangle$ is a disk, a torus with one hole, or a genus-2 surface with one hole. So $\chi(\Sigma_{a_1}/\langle Y' \rangle) \in \{1, -1, -3\}$. The ramification points of the covering $\Sigma_{a_1} \rightarrow \Sigma_{a_1}/\langle Y' \rangle$ come also into account. According to (5), there is only one ramification point Q that has 4 preimages P_1, P_2, P_3 and P_4 in Σ_{a_1} . So, with the notation of Lemma A.7, we have $o(Q) = 4$. Let us recall that in Lemma A.7, the cardinality of $\langle Y' \rangle$ is denoted by m , then here, $m = 8$. We get:

$$\underbrace{\chi(\Sigma_{a_1})}_{-4} + \underbrace{(m - o(Q))}_{8-4} = \underbrace{m}_{8} \cdot \underbrace{\chi(\Sigma_{a_1}/\langle Y' \rangle)}_{1, -1 \text{ or } -3}.$$

This equality cannot be satisfied, since the left-hand side is zero whereas the right-hand side is nonzero. This is the expected contradiction and terminates the proof of Lemma 10.1. \square

We now can prove the following proposition:

Proposition 10.2 (Description of $\hat{\rho}$).

There exist an integer $\varepsilon \in \{\pm 1\}$ and a mapping class α of $\text{Mod}(\hat{\Sigma})$ that is either the identity or

the periodic mapping class of order two that fixes the curves a_i , $i \in \{1, 2, \dots, n-1\}$ such that, for all $i \in \{0, 1, \dots, n-1\}$, the homomorphism $\widehat{\rho}$ satisfies:

$$\widehat{\rho}(\tau_i) = T_{a_i}^\varepsilon \alpha.$$

Proof.

1. Let us begin to deal with the case where \widetilde{A}_1 is trivial. In this case, \widehat{A}_1 is a multitwist along the curves of $\sigma(\widehat{\mathcal{X}})$. But $\sigma(\widehat{A}_1) = \sigma_s(A_1) \cap \text{Curv}(\widehat{\Sigma}) = \{a_1\}$, so there exists a nonzero integer ε such that $\widehat{A}_1 = T_{a_1}^\varepsilon$. Then, by applying the conjugation by the elements of $\widehat{\rho}(\mathcal{J})$, for all $i \in \{0, 1, \dots, n-1\}$, we get:

$$\widehat{\rho}(\tau_i) = \widehat{A}_i = T_{a_i}^\varepsilon. \quad (1)$$

Now, for all $i \in \{0, 1, \dots, n-1\}$, \widehat{A}_i and \widehat{A}_{i+1} satisfy a braid relation, so according to Proposition A.2, ε belongs to $\{\pm 1\}$. Thus, in the case where \widetilde{A}_1 is trivial, the proof is over.

2. When \widetilde{A}_1 is not the identity, we have $\widetilde{A}_1 = \widetilde{A}_3 = \dots = \widetilde{A}_{n-1}$ according to Lemma 10.1. According to Corollary A.15, these periodic mapping classes of order 2 all induce a unique mapping class α of order 2 on $\text{Mod}(\widehat{\Sigma})$. According to Proposition ??.(v), for all $i \in \text{Odd}(n)$, we have the inclusions $\sigma(\widehat{A}_i \alpha) \subset \sigma(\widehat{A}_i) \cup \sigma(\alpha)$ and $\sigma(\widehat{A}_i) \subset \sigma(\widehat{A}_i \alpha) \cup \sigma(\alpha^{-1})$, but $\sigma(\alpha) = \sigma(\alpha^{-1}) = \emptyset$, so we get the equality $\sigma(\widehat{A}_i \alpha) = \sigma(\widehat{A}_i) = \{a_i\}$. By definition of α , the mapping class $\widehat{A}_i \alpha$ induces a trivial mapping class in $\text{Mod}(\widehat{\Sigma})$. Hence, for all $i \in \text{Odd}(n)$, there exists an integer k_i such that:

$$\widehat{A}_i \alpha = T_{a_i}^{k_i}. \quad (2)$$

Notice that for all $\xi \in \mathcal{H}$, the mapping class $\widehat{\rho}(\xi) \alpha \widehat{\rho}(\xi)^{-1}$ is periodic of order 2 and induces in $\text{Mod}(\widehat{\Sigma})$ a mapping class that coincides with $\xi \cdot \widetilde{A}_1$. But $\xi \cdot \widetilde{A}_1 = \widetilde{A}_1$ according to Lemma 10.1, so by uniqueness of the construction of α (cf. Corollary A.15), we have the equality $\widehat{\rho}(\xi) \alpha \widehat{\rho}(\xi)^{-1} = \alpha$. Then, by conjugation by the elements of $\widehat{\rho}(\mathcal{H})$, the k_i are all equal to an integer which we denote by ε . Hence for all $i \in \text{Odd}(n)$, we have:

$$\widehat{A}_i \alpha = T_{a_i}^\varepsilon. \quad (3)$$

Since $\widehat{A}_3 \widehat{A}_4 \widehat{A}_3(\sigma_s(\widehat{A}_3)) = \sigma_s(\widehat{A}_4)$, then $\widehat{A}_3 \widehat{A}_4 \widehat{A}_3(a_3) = a_4$. Hence the product $\widehat{A}_3 \widehat{A}_4 \widehat{A}_3$ sends by conjugation T_{a_3} on T_{a_4} . Moreover, $\widehat{A}_3 \widehat{A}_4 \widehat{A}_3$ sends also by conjugation \widehat{A}_3 on \widehat{A}_4 . Hence, by conjugating the equality $\widehat{A}_1 T_{a_1}^{-\varepsilon} = \widehat{A}_3 T_{a_3}^{-\varepsilon}$ by $\widehat{A}_3 \widehat{A}_4 \widehat{A}_3$, we get $\widehat{A}_1 T_{a_1}^{-\varepsilon} = \widehat{A}_4 T_{a_4}^{-\varepsilon}$. Hence $\widehat{A}_4 T_{a_4}^{-\varepsilon} = \widehat{A}_3 T_{a_3}^{-\varepsilon}$. Now, let us make δ act on this last equality. We get (4):

$$\widehat{A}_1 T_{a_1}^{-\varepsilon} = \widehat{A}_2 T_{a_2}^{-\varepsilon} = \dots = \widehat{A}_{n-1} T_{a_{n-1}}^{-\varepsilon} = \widehat{A}_0 T_{a_0}^{-\varepsilon}. \quad (4)$$

Therefore α (equal to $\widehat{A}_1 T_{a_1}^{-\varepsilon}$) is stable by the action of δ . In other words, α commutes with $\widehat{\rho}(\delta)$. Then, since $\alpha(a_1) = a_1$, it follows that for all $i \in \{0, 1, \dots, n-1\}$, we have $\alpha(a_i) = a_i$. Hence, for all $i \in \{0, 1, \dots, n-1\}$, the mapping class α commutes with T_{a_i} , hence with $T_{a_i}^\varepsilon \alpha$. That is, α commutes with \widehat{A}_i . Therefore, the transvection of $\widehat{\rho}$ with direction α is well-defined. Let us denote it by $L_\alpha(\widehat{\rho})$. Thus, for all $i \in \{0, 1, \dots, n-1\}$, we have:

$$L_\alpha(\widehat{\rho})(\tau_i) = \widehat{A}_i \alpha = T_{a_i}^\varepsilon. \quad (5)$$

This kind of equality (5) is very similar to (1). We can then prove, exactly as in the case where \widetilde{A}_1 is trivial, that $\varepsilon \in \{\pm 1\}$. \square

10.2 The homomorphism ρ is a transvection of monodromy homomorphism

At last, we prove in this subsection Proposition 10.4: we know that the homomorphism $\widehat{\rho}$ induced by ρ is a transvection of monodromy homomorphism. We have now to check that the homomorphism ρ itself is a transvection of monodromy homomorphism.

Let us gather the main information on $\widehat{\Sigma}$, $\check{\Sigma}$ and \mathcal{U} contained in Definition 9.5 and Proposition 9.6.

Recalls (Definition 9.5 and Propositions 9.4 and 9.6).

- Let $\widehat{\Sigma}$ be the subsurface of $\text{Sub}_{\sigma_n(\mathcal{G}_0)}(\Sigma)$ containing the special curves. The surface $\widehat{\Sigma}$ is of genus $\frac{n}{2} - 1$ or $\frac{n}{2}$.
- We set $\mathcal{U} := \text{Bndy}(\widehat{\Sigma}) \cap \sigma_n(\mathcal{G}_0)$. The set of curves \mathcal{U} can be empty and contains at most two curves.
- Let $\check{\Sigma}$ be the subsurface of $\text{Sub}_{\mathcal{U}}(\Sigma)$ different from $\widehat{\Sigma}$ (well-defined according to Proposition 9.6). If $\widehat{\Sigma}$ is the only subsurface of $\text{Sub}_{\mathcal{U}}(\Sigma)$, we will say that $\check{\Sigma}$ is empty.

The links between $\widehat{\Sigma}$, $\check{\Sigma}$ and \mathcal{U} are the following:

- if \mathcal{U} is empty, $\Sigma = \widehat{\Sigma}$; if $\widehat{\Sigma}$ is of genus $\frac{n}{2}$, then \mathcal{U} is empty,
- if \mathcal{U} is reduced to a non-separating curve u , then $\check{\Sigma}$ is empty and $\{u\}$ is the mark of $\widehat{\Sigma}$,
- if \mathcal{U} is reduced to a separating curve u , then $\check{\Sigma}$ is of genus 1,
- if \mathcal{U} contains two curves, then they are non-separating and $\check{\Sigma}$ is a nonempty genus-0 surface.

Proposition 10.3. *There exists a mapping class $W \in \mathcal{PMod}(\Sigma)$ such that for all $i \in \{1, 2, \dots, n-1\}$, the following holds:*

- in $\text{Mod}(\widehat{\Sigma})$, $\wedge(W)$ commutes with $\wedge(T_{a_i})$ and $\wedge(A_i)$,
- in $\text{Mod}(\widehat{\Sigma})$, $\wedge(A_i W^{-1}) = \wedge(T_{a_i}^\varepsilon)$,
- in $\text{Mod}(\widehat{\Sigma})$, $\vee(W)$ commutes with $\vee(A_i)$,
- in $\text{Mod}(\check{\Sigma})$, $\vee(A_i W^{-1}) = \vee(T_{a_i}^\varepsilon)$.

Proof. Let us distinguish the case according to \mathcal{U} .

a) If \mathcal{U} is empty, then $\widehat{\Sigma} = \Sigma$, so $A_1 T_{a_1}^{-1}$ coincides with α , the mapping class defined in Proposition 10.2. According to this last proposition, α satisfies the four assertions that W must satisfy. Then in this case, Proposition 10.3 is proved.

b) If \mathcal{U} is reduced to a non-separating curve u , then, if α is the identity, we set $W = \text{Id}$ in the group $\mathcal{PMod}(\Sigma)$. And if α is not the identity, according to Corollary A.15, there exists a unique mapping class W of $\mathcal{PMod}(\Sigma)$, periodic of order two, fixing the curve u and such that $\text{cut}_u(W) = \alpha$. Then, again according to Proposition 10.2, this definition of W suits.

c) If \mathcal{U} is separating in Σ , which gathers all the cases not treated by a) and b) above, then we are going to show that the mapping class $W = A_1 T_{a_1}^{-1}$ belonging to $\mathcal{PMod}(\Sigma)$ suits. Let us start by showing that the homomorphism $\vee \circ \rho$ is cyclic.

The set of curves \mathcal{U} is stable by the mapping classes of \mathcal{G}_0 , for the curves of \mathcal{U} are topologically different from the other curves of $\sigma_n(\mathcal{G}_0)$: they are the only ones that separate $\widehat{\Sigma}$ from $\check{\Sigma}$. Let us distinguish two cases, depending on whether $\check{\Sigma}$ is of genus 1, or of genus 0.

- If $\check{\Sigma}$ is of genus 1, according to Proposition 9.6, \mathcal{U} is reduced to one only curve, that is hence stable by the action of $\rho(\mathcal{B}_n)$. Hence the image of the homomorphism $\vee \circ \rho$ is included in $\mathcal{PMod}(\check{\Sigma})$ (the boundary components are not permuted). Then we can apply Proposition 9.4: since $\check{\Sigma}$ is of genus 1, hence smaller than $\frac{n}{2} - 1$, then the homomorphism $\vee \circ \rho$ is cyclic.
- If $\check{\Sigma}$ is of genus zero, then \mathcal{U} can contain two curves. They can be swapped by the elements of \mathcal{G}_0 , but according to the proposition 7.14, the action of \mathcal{B}_n on \mathcal{U} is cyclic. Remember that we set in Subsection 7.1:

$$\begin{aligned}\mathcal{F}_n &= \langle\langle \tau_3 \tau_1^{-1} \rangle\rangle_{\mathcal{B}_n} = \text{Ker}(\lambda), \\ \mathcal{F}_n^* &= \langle \tau_i \tau_1^{-1}, 3 \leq i \leq n-1 \rangle_{\mathcal{B}_n} \not\subseteq \text{Ker}(\lambda).\end{aligned}$$

where $\langle\langle \cdot \rangle\rangle_{\mathcal{B}_n}$ is the normal closure in \mathcal{B}_n and $\lambda : \mathcal{B}_n \rightarrow \mathbb{Z}$ is the unique homomorphism such that $\lambda(\tau_1) = 1$. Since the action of \mathcal{B}_n on \mathcal{U} is cyclic, the induced action of \mathcal{F}_n on \mathcal{U} is trivial. Hence $\rho(\mathcal{F}_n)$ is included in $\mathcal{PMod}(\check{\Sigma})$. Now, remember that \mathcal{F}_n^* is isomorphic to \mathcal{B}_{n-2} , that $\check{\Sigma}$ is a genus-0 surface, so, according to Theorem 4.4, the homomorphism $\vee \circ \rho : \mathcal{F}_n^* \rightarrow \mathcal{PMod}(\check{\Sigma})$ is cyclic. Hence again, the homomorphism $\vee \circ \rho : \mathcal{B}_n \rightarrow \mathcal{PMod}(\check{\Sigma})$ is cyclic after Lemma 7.2.(ii).

Then, according to Proposition 10.2, the mapping class $W = A_1 T_{a_1}^{-\varepsilon}$ belonging to $\mathcal{PMod}(\Sigma)$ satisfies for all $i \in \{1, 2, \dots, n-1\}$ the following facts (where α is the mapping class of $\text{Mod}(\widehat{\Sigma})$ introduced in Proposition 10.2):

- in $\text{Mod}(\widehat{\Sigma})$, $\wedge(W)$ is equal to α and then commutes with T_{a_i} ,
- in $\text{Mod}(\widehat{\Sigma})$, $\wedge(T_{a_i}^\varepsilon W) = \widehat{A}_i$,
- in $\text{Mod}(\check{\Sigma})$, $\vee(A_i T_{a_i}^{-\varepsilon}) = \vee(A_i) = \vee(W)$.

This terminates the proof of Proposition 10.3. □

Proposition 10.4. *Under the hypotheses of this section, the homomorphism $\rho : \mathcal{B}_n \rightarrow \mathcal{PMod}(\Sigma)$ is a transvection of monodromy homomorphism.*

Proof. Let W be the mapping class of $\mathcal{PMod}(\Sigma)$ defined in Proposition 10.3. Notice that according to this same proposition, $\wedge(A_i W^{-1})$ belongs to $\mathcal{PMod}(\widehat{\Sigma})$ for all $i \in \{1, \dots, n-1\}$, since $\wedge(A_i W^{-1}) = \wedge(T_{a_i}^\varepsilon)$. Similarly, when $\check{\Sigma}$ is nonempty, $\vee(A_i W^{-1})$ belongs to $\mathcal{PMod}(\check{\Sigma})$ since $\vee(A_i W^{-1}) = \vee(T_{a_i}^\varepsilon)$. Hence $A_i W^{-1}$ and $T_{a_i}^\varepsilon$ belong to $\mathcal{P}_U \text{Mod}(\Sigma)$. Let us consider then the following central exact sequence:

$$1 \rightarrow \langle T_u, u \in \mathcal{U} \rangle \rightarrow \mathcal{P}_U \text{Mod}(\Sigma) \xrightarrow{\text{cut}_u} \mathcal{PMod}(\Sigma_U) \rightarrow 1 \quad (1)$$

where cut_U is the canonical homomorphism. For any $i \in \{1, \dots, n-1\}$, both mapping classes $A_i W^{-1}$ and $T_{a_i}^\varepsilon$ induce the same mapping classes in $\mathcal{PMod}(\Sigma_U)$. So $A_i W^{-1}$ and $T_{a_i}^\varepsilon$ differ by a central element. Consequently, W commutes with A_i . We can then define a homomorphism $\rho' : \mathcal{B}_n \rightarrow \mathcal{PMod}(\Sigma)$ by setting:

$$\rho'(\tau_i) = A_i W^{-1} = \rho(\tau_i) W^{-1}$$

for all integers $i \in \{1, \dots, n-1\}$. Let $\rho'' : \mathcal{B}_n \rightarrow \mathcal{PMod}(\Sigma)$ be the monodromy homomorphism defined by

$$\rho''(\tau_i) = T_{a_i}^\varepsilon$$

for all $i \in \{1, \dots, n-1\}$. The homomorphisms ρ' and ρ'' satisfy $\text{cut}_{\mathcal{U}}(\rho') = \text{cut}_{\mathcal{U}}(\rho'')$ according to Proposition 10.3. Let us apply Lemma 3.4 to the central exact sequence (1). It follows that ρ' and ρ'' are of the same nature, hence ρ' is a transvection of monodromy homomorphism. So by construction, ρ is also a transvection of monodromy homomorphism.

10.3 Proof of Theorem 1 when n is even

Let n be an even integer greater than or equal to 6, and Σ a surface $\Sigma_{g,b}$ where $g \leq \frac{n}{2}$. We already know (cf. Lemma 3.3) that monodromy homomorphisms exist if and only if $g \geq \frac{n}{2} - 1$. Let ρ be a noncyclic homomorphism from \mathcal{B}_n to $\mathcal{PMod}(\Sigma)$. Let Σ' be the connected component of $\Sigma_{\sigma_p(\mathcal{G}_0)}$ of genus g (recall that $\sigma_p(\mathcal{G}_0)$ is the set of peripheral curves which were introduced in Section 4). According to Proposition 4.7.(i) and (ii), the homomorphism ρ induces a noncyclic homomorphism $\rho' : \mathcal{B}_n \rightarrow \mathcal{PMod}(\Sigma')$. Then according to Proposition 10.4, ζ' is a transvection of monodromy homomorphism. Then, according to Proposition 4.7.(ii), the homomorphism ρ was a transvection of monodromy homomorphism. Hence Theorem 1 when n is even is proved.

10.4 Proof of Theorem 1 when n is odd

Let n be an odd integer greater than or equal to 7. Notice that in this case, the condition $g \leq \frac{n}{2}$ is equivalent to $g \leq \frac{n-1}{2}$. Let Σ be a surface $\Sigma_{g,b}$ where $g \leq \frac{n-1}{2}$ and $b \geq 0$. We already know (cf. Lemma 3.3) that monodromy homomorphisms exist if and only if $g \geq \frac{n}{2} - 1$. Let ρ be a noncyclic homomorphism from \mathcal{B}_n to $\mathcal{PMod}(\Sigma)$. We are going to show that ρ is a transvection of monodromy homomorphism.

We adopt the following notation:

$$\begin{aligned}\mathcal{B}_{n-1}^{(1)} &= \langle \tau_1, \tau_2, \dots, \tau_{n-2} \rangle_{\mathcal{B}_n}, \\ \mathcal{B}_{n-1}^{(2)} &= \langle \tau_2, \tau_3, \dots, \tau_{n-1} \rangle_{\mathcal{B}_n}.\end{aligned}$$

The homomorphism ρ from \mathcal{B}_n to $\mathcal{PMod}(\Sigma)$ induces by restriction to $\mathcal{B}_{n-1}^{(1)}$ and $\mathcal{B}_{n-1}^{(2)}$ the homomorphisms $\rho^{(1)} : \mathcal{B}_{n-1}^{(1)} \rightarrow \mathcal{PMod}(\Sigma)$ and $\rho^{(2)} : \mathcal{B}_{n-1}^{(2)} \rightarrow \mathcal{PMod}(\Sigma)$. The homomorphism ρ is not cyclic, so the mapping classes $\rho(\tau_2)$ and $\rho(\tau_3)$ are distinct according to Lemma 3.1. So the homomorphisms $\rho^{(1)}$ and $\rho^{(2)}$ are not cyclic either. Then, according to Theorem 1 when n is even, $\rho^{(1)}$ and $\rho^{(2)}$ are transvections of monodromy homomorphisms. So there exist two $(n-2)$ -chains: $(a_i, 1 \leq i \leq n-2)$ and $(c_i, 2 \leq i \leq n-1)$; two mapping classes: V belonging to the centralizer of $\langle T_{a_i}, 1 \leq i \leq n-2 \rangle$ in $\mathcal{PMod}(\Sigma)$ and W belonging to the centralizer of $\langle T_{c_i}, 2 \leq i \leq n-1 \rangle$ in $\mathcal{PMod}(\Sigma)$; and two integers ε and η belonging to $\{\pm 1\}$, such that for all $i \in \{1, \dots, n-2\}$:

$$\begin{cases} \rho^{(1)}(\tau_i) = T_{a_i}^\varepsilon V, \\ \rho^{(2)}(\tau_{i+1}) = T_{c_{i+1}}^\eta W. \end{cases}$$

The homomorphisms $\rho^{(1)}$ and $\rho^{(2)}$ coincide on the standard generators τ_i with $2 \leq i \leq n-2$, so they coincide on at least four consecutive standard generators (four when $n = 7$). Then according to Lemma 3.5, we have $V = W$, $\varepsilon = \eta$, and $a_i = c_i$ for all $i \in \{2, 3, \dots, n-2\}$. Let us denote by a_{n-1} the curve c_{n-1} . Then, we have for all $i \in \{1, \dots, n-1\}$:

$$\rho(\tau_i) = T_{a_i}^\varepsilon V.$$

We just have to check that this is a transvection of monodromy homomorphism.

- On one hand, the mapping class V is in the centralizer of $\langle T_{a_i}, 1 \leq i \leq n-1 \rangle$, since the equality $V = W$ implies that V commutes with $T_{a_{n-1}}$ as well;
- On the other hand, the ordered list of curves $(a_i, 1 \leq i \leq n-1)$, is an $(n-1)$ -chain, since the curve a_{n-1} intersects a_{n-2} in one point, does not intersect the curves a_i for $i \in \{2, \dots, n-3\}$, and does not intersect either a_1 . Let us justify this last point: τ_1 and τ_{n-1} commute, so $\rho(\tau_1)$ and $\rho(\tau_{n-1})$ commute, so $T_{a_1}V$ and $T_{a_{n-1}}V$ commute. But V commutes with T_{a_1} and $T_{a_{n-1}}$, so finally, T_{a_1} and $T_{a_{n-1}}$ commute, so we have $I(a_1, a_{n-1}) = 0$.

Thus, ρ is a transvection of monodromy homomorphism. Hence Theorem 1 is proved.

Appendix

A Miscellaneous on the mapping class group

A.1 Parabolic subgroups of the mapping class group

The concept of *parabolic subgroup of the mapping class group* has been introduced by L. Paris and D. Rolfsen in [PaRo]: given a surface Σ , the *parabolic subgroups of the mapping class group of Σ* are the subgroups induced by the inclusion of subsurfaces in Σ . The next Theorem, due to Paris and Rolfsen, deals with some kernels associated with parabolic subgroups of the mapping class group.

Theorem A.1 (Paris and Rolfsen, [PaRo]).

Let Σ be a surface and Σ' a subsurface in Σ such that $\partial\Sigma'$ and $\partial\Sigma$ are disjoint. We denote by a_1, a_2, \dots, a_r the boundary components of Σ' that bound a disk in Σ ; we denote by b_j, b'_j for $1 \leq j \leq s$ the pairs of boundary components of Σ' that cobound an annulus in Σ . Then the inclusion $\iota : \Sigma' \rightarrow \Sigma$ induces a homomorphism $\iota_* : \text{Mod}(\Sigma', \partial\Sigma') \rightarrow \text{Mod}(\Sigma, \partial\Sigma)$ whose kernel is the abelian group \mathcal{T} of rank $r + s$ spanned by $T_{a_i}, 1 \leq i \leq r$ and by $T_{b_j}^{-1}T_{b'_j}, 1 \leq j \leq s$.

A.2 Interactions between Dehn twists and the braid group

The properties of the Dehn twists are well-known. We simply mention them.

Proposition A.2 (Dehn twists' properties, N.V. Ivanov, J.D. McCarthy [Mc1]).

- For all F in $\text{Mod}(\Sigma)$, we have $FT_a = T_aF$ if and only if $F(a) = a$.
- Let T_a and T_b be two Dehn twists, and i and j two nonzero integers. The relation $T_a^i T_b^j = T_b^j T_a^i$ holds if and only if $I(a, b) = 0$.
- Let T_a and T_b be two Dehn twists, and i and j two nonzero integers. The braid relation $T_a^i T_b^j T_a^i = T_b^j T_a^i T_b^j$ holds if and only if $I(a, b) = 1$ and $i = j = \pm 1$. \square

Proposition A.3 (C. Labrure, L. Paris, cf. [LaPa]).

Let (c_1, c_2, \dots, c_k) be a k -chain of curves where k is an integer greater than or equal to 2. Then,

- if k is even, the tubular neighbourhood of $c_1 \cup c_2 \cup \dots \cup c_k$ is a surface S (in grey on Figure 40) of genus $\frac{k}{2}$ with one boundary component which we call d , and the product $(T_{c_1}(T_{c_2}T_{c_1}) \dots (T_{c_k} \dots T_{c_2}T_{c_1}))^2$ is the mapping class α that preserves each curve c_i , $1 \leq i \leq k$, whose restriction outside of S coincides with the identity, and such that $\alpha^2 = T_d$ (cf. Figure 40). Notice that after having given orientations to the curves c_i , $1 \leq i \leq k$, the mapping class α inverse them.

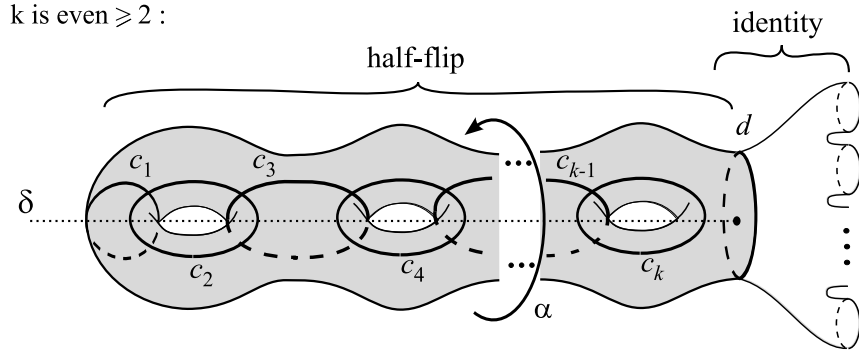

Figure 40: The product $(T_{c_1}(T_{c_2}T_{c_1}) \dots (T_{c_k} \dots T_{c_2}T_{c_1}))^2$ when k is even.

- if k is odd, the tubular neighbourhood of $c_1 \cup c_2 \cup \dots \cup c_k$ is a surface S (in grey on Figure 41) of genus $\frac{k-1}{2}$ with two boundary components d_1 and d_2 , and the product $(T_{c_1}(T_{c_2}T_{c_1}) \dots (T_{c_k} \dots T_{c_2}T_{c_1}))^2$ equals the product $T_{d_1} T_{d_2}$ (cf. Figure 41). \square

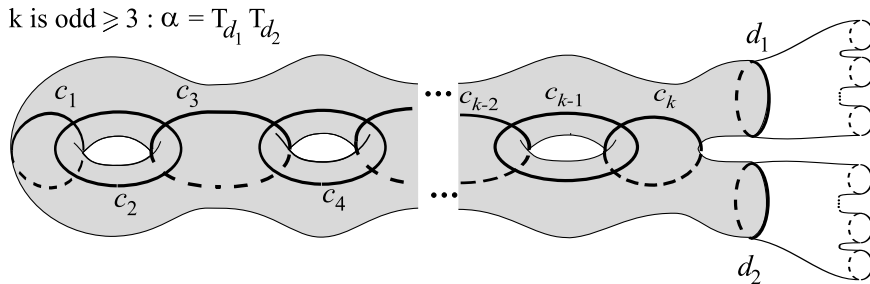

Figure 41: The product $T_{c_1}(T_{c_2}T_{c_1}) \dots (T_{c_k} \dots T_{c_2}T_{c_1})$ when k is odd.

Let k be an integer and let Σ be the surface in grey in Figure 40 if k is odd or in Figure 41 if k is even. Using Proposition A.2, there is an obvious homomorphism from \mathcal{B}_{k+1} to $\text{Mod}(\Sigma, \partial\Sigma)$ sending τ_i on T_{c_i} for all $i \leq k+1$. Let us denote it by ρ_{ref} . Then:

Theorem A.4 (Geometric embedding the braid group, Birman & Hilden, [BiHi]).

The homomorphism $\rho_{\text{ref}} : \mathcal{B}_{k+1} \rightarrow \text{Mod}(\Sigma, \partial\Sigma)$ is injective.

The following Theorem is due independently to M. Dehn [D] and W.B.R. Lickorish [Lk]. For the proof of Part 1, the reader is referred to [Bi], Theorem 4.1. Part 2 is a consequence of Part 1, using *lantern relations* (cf. [FaMa] section 5.1) in order to obtain the Dehn twists along the boundary curves.

Theorem A.5 (The mapping class group is spanned by Dehn twists).

1. Let $\Sigma_{g,b}$ be a surface whose genus satisfies $g \geq 1$. The group $\mathcal{P}\text{Mod}(\Sigma_{g,b})$ is spanned by the Dehn twists along the non-separating curves of $\Sigma_{g,b}$. Actually, one can for instance consider only the curves drawn in Figure 42.
2. The same Dehn twists can be seen as lying in $\text{Mod}(\Sigma_{g,b}, \partial\Sigma_{g,b})$; in this case they span $\text{Mod}(\Sigma_{g,b}, \partial\Sigma_{g,b})$. \square

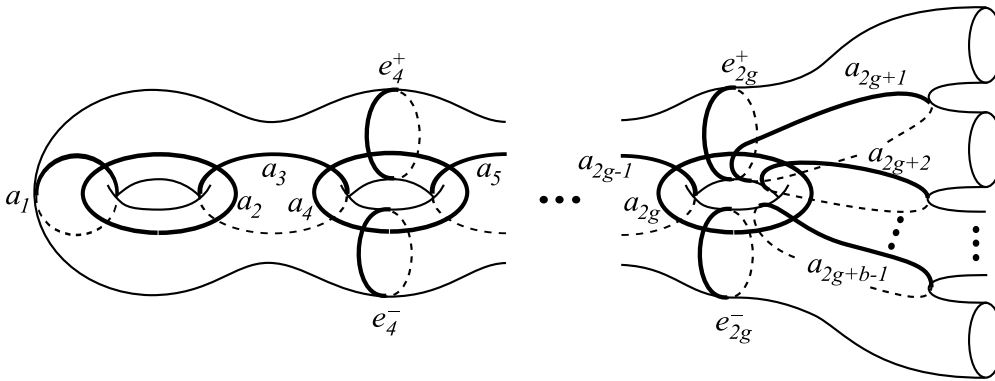

Figure 42: Curves in $\Sigma_{g,b}$ span $\mathcal{P}\text{Mod}(\Sigma_{g,b})$.

A.3 Periodic Mapping classes

A.3.1 Kerckhoff's Theorem, Riemann-Hurwitz formula, and related results

According to the Nielsen realization theorem, every periodic mapping class on a closed surface is the isotopy class of an isometry of the surface with a specific metric depending on the mapping class (and of course, the isometry has the same order as the mapping class). Given a connected surface Σ together with a hyperbolic metric g , we denote by $\text{Isom}^+(\Sigma, g)$ the group of positive isometries of (Σ, g) , which is a subgroup of $\text{Diff}^+(\Sigma)$. This Theorem has been generalized by Kerckhoff to finite subgroups of $\text{Mod}(\Sigma)$ where $\partial\Sigma$ is possibly nonempty (cf. [Ke1] and [Ke2]):

Theorem A.6 (“Nielsen Realization Problem”, Kerckhoff, cf. [Ke2]).

Let Σ be a surface with a possibly nonempty boundary. Let Γ be a finite subgroup of $\text{Mod}(\Sigma)$. Then, there exists a finite group $\bar{\Gamma}$ of $\text{Diff}^+(\Sigma)$ such that the natural homomorphism $\text{Diff}^+(\Sigma) \rightarrow \text{Mod}(\Sigma)$ sends isomorphically $\bar{\Gamma}$ on Γ . Moreover, we can choose $\bar{\Gamma}$ as a subgroup of the isometry group of Σ equipped with a metric of constant curvature, where the boundary components are geodesics.

Lemma A.7 (Riemann-Hurwitz Formula).

Let Σ be a surface with a possibly trivial boundary and let Γ be a finite subgroup of order m of $\text{Diff}^+(\Sigma)$, such that $m \geq 1$. Then Σ/Γ is a surface and the quotient map $\pi : \Sigma \rightarrow \Sigma/\Gamma$ is a ramified covering. Let Q_1, \dots, Q_ℓ be the ramification points of π , and, for $1 \leq i \leq \ell$, let $o(Q_i)$ be the number of preimages of Q_i by π . Then the Euler characteristics of the surfaces Σ and Σ/Γ are linked by the formula:

$$\chi(\Sigma) + \sum_{i=1}^{\ell} (m - o(Q_i)) = m \cdot \chi(\Sigma/\Gamma).$$

□

Ramification points and singular points.

The points of Σ/Γ whose number of preimages by π is smaller than $|\Gamma|$ are called *ramification points*. Their preimages in Σ are called *singular points*. Let us make some remarks:

- For all i , the group Γ acts transitively on $\pi^{-1}(\{Q_i\})$. For this reason, the cardinality of $\pi^{-1}(\{Q_i\})$, denoted by $o(Q_i)$, divides m .
- When Γ is spanned by a unique element f , for all $i \leq \ell$, the action of f on $\pi^{-1}(\{Q_i\})$ is cyclic, so $\pi^{-1}(\{Q_i\})$ belongs to $\text{Fix}(f^{o(Q_i)})$, the set of fixed points of $f^{o(Q_i)}$. However, according to Lefschetz Theorem, the number of fixed points of f and of its powers depends only on the isotopy class of f (let us make clear that in Lefschetz Theorem, the number of fixed points takes into account the multiplicity of each fixed point, but in the case of nontrivial isometries, this integer always equals 1). Hence the data of ℓ and $\{o(Q_i) \mid 1 \leq i \leq \ell\}$ is an invariant of the isotopy class of f . Since $\chi(\Sigma/\langle f \rangle)$ and the number of boundary components of $\Sigma/\langle f \rangle$ are also invariant by isotopy on f , the surface $\Sigma/\langle f \rangle$ itself is an invariant of the isotopy class of f .
- This lemma together with Kerckhoff's Theorem have a lot of corollaries and here are some of them that we will use in this paper.

Corollary A.8 (Fixed points and preserved boundary components preserved).

Let Σ be a surface $\Sigma_{g,b}$ and let F be a periodic mapping class of $\text{Mod}(\Sigma)$ of order m . Then, the sum of the number of boundary components preserved by F and the number of fixed points of F is bounded by $2 + \frac{2g}{m-1}$.

Proof. Let \bar{F} be a diffeomorphism of order m representing F . Let b' be the number of boundary components preserved by \bar{F} and let ℓ' be the number of fixed points of \bar{F} . Let \mathcal{D} be the set of boundary components of Σ that are not fixed by \bar{F} . Let Σ' be the surface obtained from Σ where each boundary components of \mathcal{D} have been filled. Let \bar{F}' the diffeomorphism induced by \bar{F} on Σ' . Let us apply Lemma A.7 to \bar{F}' , and let us adopt the notation of the statement. The order m of \bar{F}' (equal to the order of \bar{F}) coincides with the order of the group $\Gamma = \langle \bar{F}' \rangle$. In addition, notice that:

- $\chi(\Sigma') = 2 - 2g - b'$;
- for all fixed point Q , we have $o(Q) = 1$;
- $\sum_{i=1}^{\ell'} (m - o(Q_i)) \geq \ell' (m - 1)$;
- $\chi(\Sigma'/\Gamma) \leq 2 - b'$.

Finally, we get:

$$(2 - 2g - b') + \ell'(m - 1) \leq m \cdot (2 - b'),$$

whence:

$$(m - 1)b' + \ell'(m - 1) \leq 2(m - 1) + 2g,$$

whence the formula: $b' + \ell' \leq 2 + \frac{2g}{m-1}$.

□

The following corollary is the special case $g = 0$.

Corollary A.9 (Periodic mapping classes on a sphere).

Let S be a holed sphere and F a periodic mapping class of $\text{Mod}(S)$. If there exist at least three boundary components in S preserved by F , then F is the identity of $\text{Mod}(S)$.

□

Finally the following result is a technical corollary of Lemma A.7 which gives an upper bound to the cardinality of a finite subgroup of the mapping class group of a surface Σ of genus g . It is due to Hurwitz. For a proof, see [FaMa], section 6.2.

Corollary A.10 (“ $84(g - 1)$ ” Theorem).

Let Σ be a connected surface of genus at least 2 without boundary. The order of a finite subgroup of the mapping class group is bounded by $42|\chi(\Sigma)|$ (which is equal to $84(g - 1)$).

□

When the finite subgroup of the mapping class group is cyclic, we have much more precise upper bound:

Proposition A.11 (“ $4g + 2$ ” Theorem).

The order of a periodic mapping class in $\text{Mod}(\Sigma_{g,0})$ is bounded by $4g + 2$.

We need a more general statement when $g = 1$.

Lemma A.12 (Order of periodic mapping classes in $\mathcal{P}\text{Mod}(\Sigma_{1,b})$, $b \geq 0$).

Any mapping class of $\mathcal{P}\text{Mod}(\Sigma_{1,b})$ with $b \geq 0$ is of order smaller than or equal to 6.

Proof. When $b = 0$, this is the “ $4g + 2$ ” theorem. When $b = 1$, it comes from the fact that $\text{Mod}(\Sigma_{1,0}) = \text{Mod}(\Sigma_{1,1})$. For the case $b = 2$, we use the fact that $\mathcal{P}\text{Mod}(\Sigma_{1,2})$ is isomorphic to the quotient of \mathcal{B}_4 by its center, and it is well-known that the order of the periodic elements of \mathcal{B}_n modulo its center is smaller than or equal to n . Finally, when $b \geq 3$, according to Corollary A.8, for any periodic element of order m we have the inequality $b \leq 2 + \frac{2g}{m-1}$ where $g = 1$, hence $m \leq 1 + \frac{2}{b-2}$. So $m \leq 3$. In all cases, the order of a periodic mapping class is less than or equal to 6.

□

A.3.2 When periodic mapping classes preserve a boundary component

In this subsection, we consider a surface Σ with a nonempty boundary, we choose a boundary component d , and look only at the mapping class group of Σ that preserve globally d . All the following results are based on a classic result coming from the Riemannian manifolds theory:

Lemma A.13. *Let M a Riemannian manifold and f an isometry on M . If f fixes a point x and if its differential in x is the identity, then f is the identity. We have the same conclusion when f fixes a boundary curve of M pointwise. \square*

Corollaries of Lemma A.13. Lemma A.13 is fundamental to the comprehension of the periodic mapping classes and induces many essential corollaries in this paper:

- Lemma A.14: “If $\partial\Sigma$ is nonempty, then $\text{Mod}(\Sigma, \partial\Sigma)$ is torsion-free.”
- Corollary A.15 of Lemma A.14, which allows us to deduce the existence of some periodic mapping classes from the existence of some other periodic mapping classes lying in “smaller” subsurface (i.e. of smaller genus or of greater Euler characteristic).
- Lemma A.16: “If $\partial\Sigma$ is nonempty and if d belongs to $\text{Bndy}(\Sigma)$, then any finite subgroup of $\text{Mod}_d(\Sigma)$ is cyclic.”

Lemma A.14 (Behaviour of periodic mapping classes in the neighbourhood of $\partial\Sigma$).

Let Σ be a connected surface such that $\partial\Sigma \neq \emptyset$. Let d be a boundary curve of Σ and let $\text{Mod}(\Sigma, d)$ be the group of the mapping classes of Σ that fix d pointwise. Then the group $\text{Mod}(\Sigma, d)$ is torsion-free. Moreover, let F be a periodic mapping class of period $m \geq 2$ and belonging to $\text{Mod}(\Sigma, d)$. Then there exists an integer ℓ coprime to m such that $F^m = T_d^\ell$ (in particular, ℓ is nonzero).

Proof. Remember that a mapping class in $\text{Mod}(\Sigma, d)$ is said to be periodic if one of its nonzero power induces the trivial mapping class in $\text{Mod}(\Sigma)$. So any mapping class that would belong to the torsion of $\text{Mod}(\Sigma, d)$ is by definition a periodic mapping class. However if we show that any nonzero power of any periodic mapping class is nontrivial in $\text{Mod}(\Sigma, d)$, we will have shown that $\text{Mod}(\Sigma, d)$ is torsion-free. So the second part of Lemma A.14 implies the first part. Hence, by showing the second part, we will be done.

Let \bar{F} be a diffeomorphism in $\text{Diff}^+(\Sigma, d)$ which represents F and fixes d pointwise. Let d' be a curve isotopic to d in Σ that lies outside of $\partial\Sigma$. Let us call \mathcal{V} the compact cylinder included in Σ whose both boundary components are d and d' . Let Σ' be the closure of the complement of \mathcal{V} in Σ (cf. Figure 43).

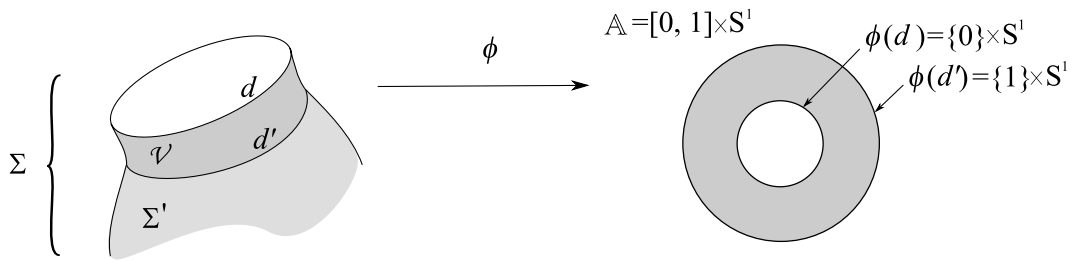

Figure 43: The situation described in proof of Lemma A.14.

Let us apply the Nielsen - Kerckhoff realization theorem: there exist a hyperbolic metric g on Σ' and an isometry \bar{F}_1 of (Σ', g) representing the restriction of F to Σ' . Let us denote by f the restriction of \bar{F}_1 to d' . Since \bar{F}_1 is a periodic isometry of order m , there exists an integer

k such that f is a rotation of angle $\frac{2k\pi}{m}$ on d' equipped with the induced metric. But for all $p \in \{1, 2, \dots, m-1\}$, the mapping class $(\text{for}_d(F))^p$ (where $\text{for}_d(F)$ is the mapping class induced by F in $\text{Mod}(\Sigma)$) is different from the identity, so according to Lemma A.13, f^p is different from the identity. Hence k is coprime to m .

Let \mathbb{A} be the annulus $[0, 1] \times S^1$ and ϕ a positive diffeomorphism of \mathcal{V} in \mathbb{A} such that $\phi(d) = \{0\} \times S^1$ and $\phi(d') = \{1\} \times S^1$ (cf. Figure 43). Moreover, we can construct ϕ so that the map $\phi \circ f \circ \phi^{-1}$ from $\{1\} \times S^1$ to $\{1\} \times S^1$ coincides with the function $(1, e^{i\theta}) \mapsto (1, e^{i(\theta + \frac{2k\pi}{m})})$, for f is an angle $\frac{2k\pi}{m}$ rotation on d' . We extend f on \mathcal{V} (cf. Figure 44) by setting for all $t \in [0, 1]$ and $\theta \in [0, 2\pi[$:

$$f(\phi^{-1}((t, e^{i\theta}))) = \phi^{-1}((t, e^{i(\theta + \frac{2k\pi}{m}t)})).$$

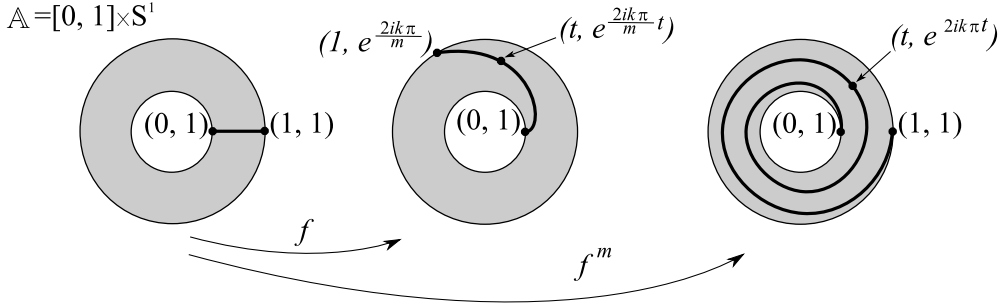

Figure 44: Image of the segment $[0, 1] \times \{1\}$ by f and f^m .

In this way, f fixes d pointwise and coincides with \bar{F}_1 on d' . Let \bar{F}_2 be the homeomorphism of Σ fixing d pointwise and coinciding with f on \mathcal{V} and with \bar{F}_1 on Σ' . By definition of a Dehn twist, the isotopy class of the homeomorphism \bar{F}_2^m is equal to $T_d^k \in \text{Mod}(\Sigma, d)$. Let G be the mapping class of $\text{Mod}(\Sigma, d)$ containing the homeomorphism $\bar{F}\bar{F}_2^{-1}$. By construction, we have $\text{for}_d(\bar{F}) = \text{for}_d(\bar{F}_2)$, so, according to the following central exact sequence:

$$1 \rightarrow \langle T_d \rangle \rightarrow \text{Mod}(\Sigma, d) \xrightarrow{\text{for}_d} \text{Mod}_d(\Sigma) \rightarrow 1,$$

the isotopy classes of \bar{F} and \bar{F}_2^{-1} in $\text{Mod}(\Sigma, d)$ commute, so the homeomorphisms $(\bar{F}\bar{F}_2^{-1})^m$ and $\bar{F}^m \bar{F}_2^{-m}$ are isotopic, hence $G^m = \bar{F}^m T_d^{-k}$. But $\text{for}_d(\bar{F}) = \text{for}_d(\bar{F}_2)$, so, according to the same exact sequence, there exists an integer j such that $G = T_d^j$. These two last equalities imply that $F^m = G^m T_d^k = T_d^{jm+k}$, and $jm+k$ is coprime to m . \square

Let us give a corollary of Lemma A.14 that will allow us to show the existence of some periodic mapping classes from periodic mapping classes defined on “smaller” surfaces (i.e. of smaller genus or of greater Euler characteristic).

Corollary A.15 (Rebuilding a periodic mapping class).

Let Σ be a connected surface. Let I be a finite set and let $\mathcal{A}_I = \{a_i, i \in I\}$ be a curve simplex in Σ . For all $i \in I$, we denote by a_i^+ and a_i^- the boundary components of $\Sigma_{\mathcal{A}_I}$ coming from the cut of \mathcal{A}_I along the curve a_i . Let \tilde{F} be a periodic mapping class of $\text{Mod}(\Sigma_{\mathcal{A}_I})$ of order two that preserves $\{a_i^+, a_i^-\}$ for all $i \in I$. Then there exists a unique periodic mapping class $F \in \text{Mod}(\Sigma)$ of order two such that F induces \tilde{F} in $\text{Mod}(\Sigma_{\mathcal{A}_I})$.

Proof.

1. Notation

Let J and K be two subsets of I such that $J \sqcup K$ forms a partition of I and such that for all $j \in J$, the boundary components a_j^+ and a_j^- of $\Sigma_{\mathcal{A}_I}$ are swapped by \tilde{F} , whereas for all $k \in K$, the boundary components a_k^+ and a_k^- of $\Sigma_{\mathcal{A}_I}$ are not. Let $\mathcal{A}_J = \{a_j, j \in J\}$ and $\mathcal{A}_K = \{a_k, k \in K\}$.

2. Existence of F

Let \bar{F}_1 be a diffeomorphism of $\text{Diff}^+(\Sigma_{\mathcal{A}_I})$ of order 2 representing \tilde{F} . We construct a diffeomorphism \bar{F}_2 of $\text{Diff}^+(\Sigma_{\mathcal{A}_K})$ by identifying in $\Sigma_{\mathcal{A}_I}$ a_j^+ and a_j^- thanks to the following relation in $\Sigma_{\mathcal{A}_I}$: for all pairs of points $(x, y) \in \Sigma_{\mathcal{A}_I}$,

$$x \sim y \text{ if and only if } \begin{cases} x = y, \\ \text{or} \\ x, y \in a_j^+ \cup a_j^- \text{ and } y = \bar{F}_1(x). \end{cases}$$

The differential structure of $\Sigma_{\mathcal{A}_K}$ induced by the one of $\Sigma_{\mathcal{A}_I}$ is well-defined up to conjugation by a diffeomorphism (cf. [Hi] page 184: *Gluing Manifolds Together*); and by construction, \bar{F}_2 is a diffeomorphism of $\Sigma_{\mathcal{A}_K}$. Let F_2 be the mapping class of $\text{Mod}(\Sigma_{\mathcal{A}_K})$ containing \bar{F}_2 . It is clear that F_2 is periodic of order two. Notice that F_2 preserves each boundary a_k^ε , $k \in K$, $\varepsilon \in \{+, -\}$. One can then define F_3 as being a representative of F_2 in $\text{Mod}(\Sigma_{\mathcal{A}_K}, \{a_k^+, a_k^-, k \in K\})$. According to Lemma A.14, for all $k \in K$, there exist two odd integers m_k^+ and m_k^- such that:

$$F_3^2 = \prod_{k \in K} T_{a_k^+}^{m_k^+} T_{a_k^-}^{m_k^-}.$$

Let F_4 be the mapping class of $\text{Mod}(\Sigma)$ obtained by identifying the boundary components a_k^+ and a_k^- for all $k \in K$. Thus F_4 satisfies the equality:

$$F_4^2 = \prod_{k \in K} T_{a_k}^{(m_k^+ + m_k^-)}.$$

Let us set $F_5 = F_4 \left(\prod_{k \in K} T_{a_k}^{\ell_k} \right)^{-1}$, where, for all $k \in K$, the rational ℓ_k defined by $\ell_k = \frac{m_k^+ + m_k^-}{2}$ is an integer since m_k^+ and m_k^- are both odd. Since this product is commutative, we have $F_5^2 = \text{Id}$. By construction, the mapping class F_5 fixes the curves of \mathcal{A}_I and induces in $\text{Mod}(\Sigma_{\mathcal{A}_I})$ the mapping class \tilde{F} . So the mapping class F_5 plays the role of F in the statement of Corollary A.15.

3. Uniqueness of F

Let us assume that there exist two mapping classes F and F' in $\text{Mod}_{\mathcal{A}_I}(\Sigma)$ such that $F^2 = F'^2 = \text{Id}$ and such that F and F' induce \tilde{F} in $\text{Mod}(\Sigma_{\mathcal{A}_I})$. According to the following exact sequence:

$$1 \rightarrow \langle T_{a_i}, i \in I \rangle \rightarrow \text{Mod}_{\mathcal{A}_I}(\Sigma) \rightarrow \text{Mod}(\Sigma_{\mathcal{A}_I}) \rightarrow 1,$$

there exist some integers p_i , $i \in I$ and a mapping class $W = \prod_{i \in I} T_{a_i}^{p_i}$ such that $F' = FW$. But F and F' fix the curves of \mathcal{A}_I , so these two mapping classes commute with W and we have $(FF'^{-1})^2 = W^2$. However, FF'^{-1} is periodic of order two as a commutative product of two periodic mapping classes of order two, so the mapping class $W^2 = \prod_{i \in I} T_{a_i}^{2p_i}$ is trivial. Then for all $i \in I$, we have $2p_i = 0$, so W is trivial. Therefore $F = F'$. \square

Lemma A.16. *Let Σ be a connected surface with a nonempty boundary and let d be a boundary component. Any finite subgroup of $\text{Mod}_d(\Sigma)$ is cyclic.*

Proof. Let Γ be a finite group included in $\text{Mod}_d(\Sigma)$. According to Kerckhoff's Theorem (cf. Theorem A.6) there exist a hyperbolic metric g on Σ and a finite group $\bar{\Gamma}$ of $\text{Isom}^+(\Sigma, g)$ that

is sent isomorphically on Γ by the natural homomorphism $\text{Diff}^+(\Sigma) \rightarrow \mathcal{M}\text{od}(\Sigma)$. Let us give an orientation to d and define the map

$$\theta : \bar{\Gamma} \rightarrow \mathbb{R}/2\pi\mathbb{Z}$$

that sends an isometry \bar{K} to the angle of the induced rotation by \bar{K} on d . It is clear that θ is a homomorphism. According to Lemma A.13, any isometry that fixes d pointwise is the identity, so θ is an injective homomorphism. Thus Γ is isomorphic to a finite subgroup of $\mathbb{R}/2\pi\mathbb{Z}$, hence Γ is cyclic. \square

A.4 The theory of Pseudo-Anosov diffeomorphisms.

We will now recall the fundamental results of the theory of the *pseudo-Anosov diffeomorphisms* on surfaces without boundary, in order to prove Proposition ???. There exists a very rich literature concerning this theory. In this subsection, we will lean mainly on the article of C. Bonatti and L. Paris [BoPa], section 2. The classic references are [FLP], [Th], [BlCa], [Iv2]. Let us begin by a remark on the terminology concerning the “pseudo-Anosov diffeomorphisms”. In this subsection, Σ is a surface without boundary.

Pseudo-Anosov diffeomorphisms and homeomorphisms. Let us recall that the “pseudo-Anosov diffeomorphisms” on a surface Σ are actually both homeomorphisms on Σ , and diffeomorphisms on the surface Σ minus a finite number of points. In the neighbourhood of these points, called *singular points*, the homeomorphisms are not differentiable although they are perfectly known, cf. [BoPa]. For this reason C. Bonatti and L. Paris [BoPa] speak about “pseudo-Anosov homeomorphisms” when we speak about “pseudo-Anosov diffeomorphisms”, but we deal with the same objects. Let us recall that there exist true diffeomorphisms in the isotopy class of a “pseudo-Anosov diffeomorphism” (isotopic means here linked by a path of homeomorphisms) and a “pseudo-Anosov diffeomorphism” defines always a unique isotopy class of true diffeomorphisms, so it defines a unique mapping class.

Properties of pseudo-Anosov diffeomorphisms. The fundamental theorem of the pseudo-Anosov theory, due to Thurston (cf. [BlCa], [Th]), is the following:

A mapping class $F \in \mathcal{M}(\Sigma)$ is pseudo-Anosov in the sense of Definition ??, if and only if there exists a “pseudo-Anosov diffeomorphism” (cf. below) $\bar{F} \in \text{Diff}(\Sigma)$ representing F .

Instead of a definition of “pseudo-Anosov diffeomorphism”, we describe some of their properties. This will be enough for our purpose. Let \bar{F} be any “pseudo-Anosov diffeomorphism” in $\text{Diff}(\Sigma)$. By definition, \bar{F} satisfies the following properties:

The foliations \mathcal{F}^s , \mathcal{F}^u , Singular points, separatrices and indexes. There exist a finite set \mathcal{S} of points in Σ preserved by \bar{F} and a pair of transverse measured regular foliations on $\Sigma \setminus \mathcal{S}$. We say we have a unique pair of transverse measured singular foliations \mathcal{F}^s and \mathcal{F}^u invariant by \bar{F} on Σ that are preserved by Σ . These foliations are called the *stable and unstable foliations* (cf. [BoPa]). An integer $k \geq 3$ is associated to each singular point $P \in \mathcal{S}$ and corresponds to the number of leaves of \mathcal{F}^s that end in P (taking \mathcal{F}^u instead of \mathcal{F}^s would have lead to the same number). These leaves ending in a singular point will be called *separatrices* (cf. [BoPa]). The integer k associated to a singular point P will be denoted by $\text{Ind}(\mathcal{F}^s, \mathcal{F}^u : P)$ and called *the index of $(\mathcal{F}^s, \mathcal{F}^u)$ at the singular point P* . Let us put the emphasis on the fact that for any $P \in \mathcal{S}$, we have $\text{Ind}(\mathcal{F}^s, \mathcal{F}^u : P) \geq 3$. Furthermore, each separatrix contains a unique singular

point (cf. [BoPa] proposition 2.1, assertion (3)). The indices and the Euler characteristic of Σ satisfy the following (see [FLP], Expos 5):

Proposition A.17.

$$\chi(\Sigma) = \sum_{P \in \mathcal{S}} \left(1 - \frac{\text{Ind}(\mathcal{F}^s, \mathcal{F}^u : P)}{2} \right).$$

The group $\text{Norm}(\mathcal{F}^s, \mathcal{F}^u)$ and the homomorphism L . Let us denote by $\text{Norm}(\mathcal{F}^s, \mathcal{F}^u)$ the set of diffeomorphisms of $\text{Diff}(\Sigma)$ that preserve \mathcal{F}^s and \mathcal{F}^u . The elements of $\text{Norm}(\mathcal{F}^s, \mathcal{F}^u)$ send the singular points on singular points of same index. They are either pseudo-Anosov or periodic. Proposition A.18 gives the main properties of the *dilatation coefficient* $\lambda^u(\cdot)$ (cf. [BoPa]) of the diffeomorphisms of $\text{Norm}(\mathcal{F}^s, \mathcal{F}^u)$, using the homomorphism

$$L : \begin{array}{ccc} \text{Norm}(\mathcal{F}^s, \mathcal{F}^u) & \longrightarrow & \mathbb{R} \\ \bar{G} & \longmapsto & \log(\lambda^u(\bar{G})) \end{array} .$$

We won't use the definition of the dilatation coefficient, but only the existence of the homomorphism L and Proposition A.18 below.

Proposition A.18 (Properties of L).

The homomorphism $L : \text{Norm}(\mathcal{F}^s, \mathcal{F}^u) \rightarrow \mathbb{R}$ (depending on the pseudo-Anosov diffeomorphism \bar{F}) satisfies the five following properties:

- (i) *the real number $L(\bar{F})$ satisfies $L(\bar{F}) > 0$,*
- (ii) *the image of L is isomorphic to \mathbb{Z} ,*
- (iii) *the kernel $\text{Ker}(L)$ acts freely on the set of separatrices of \mathcal{F}^u ,*
- (iv) *the kernel $\text{Ker}(L)$ is a finite group.*

Proof.

- (i) By definition of the dilatation coefficient, $L(F) = \log(\lambda^u(F))$ satisfies $L(F) > 0$ for $\lambda^u(F) > 1$ (cf. [FLP], Expos 9).
- (ii) We refer to [ArYo] for this result.
- (iii) Since $\text{Ker}(L)$ is included in $\text{Norm}(\mathcal{F}^s, \mathcal{F}^u)$, the elements of $\text{Ker}(L)$ preserve \mathcal{F}^u and permute the separatrices. According to Lemma 2.11 of [BoPa], the induced action by $\text{Ker}(L)$ on the set of separatrices of \mathcal{F}^u is free (the group $\text{Ker}(L)$ is denoted by $\text{Sym}(\mathcal{F}^s, \mathcal{F}^u)$ in [BoPa]).
- (iv) Since \mathcal{S} is finite and since only a finite number of separatrices end in each singular point, the set of separatrices is finite. But $\text{Ker}(L)$ acts freely on it, hence $\text{Ker}(L)$ is a finite group. \square

Let us recall that for all pseudo-Anosov mapping classes $F \in \text{Mod}(\Sigma)$, we have defined $\widetilde{\text{Centr}}(F)$ as being the set of mapping classes $G \in \text{Mod}(\Sigma)$ such that for some nonzero integer m , the mapping classes G and F^m commute (cf. Definition ??).

Let us make clear that the group $\widetilde{\text{Centr}}(F)$ contains the centralizer of F , but is not equal to it in general. The aim of this definition is to prepare the following proposition which establishes an isomorphism between $\widetilde{\text{Centr}}(F)$ and $\text{Norm}(\mathcal{F}^s, \mathcal{F}^u)$.

Proposition A.19 (Realization of $\widetilde{\text{Centr}}(F)$ in $\text{Norm}(\mathcal{F}^s, \mathcal{F}^u)$).

Let F be a pseudo-Anosov mapping class of $\text{Mod}(\Sigma)$ and let \mathcal{F}^s and \mathcal{F}^u be the stable and unstable foliations of a pseudo-Anosov diffeomorphism \bar{F} representing F . Then there exists a unique isomorphism

$$\psi : \begin{array}{ccc} \widetilde{\text{Centr}}(F) & \longrightarrow & \text{Norm}(\mathcal{F}^s, \mathcal{F}^u) \\ G & \longmapsto & \bar{G} \end{array}$$

where for all $G \in \widetilde{\text{Centr}}(F)$, \bar{G} is a representative of G in $\text{Norm}(\mathcal{F}^s, \mathcal{F}^u)$.

Proof. We show actually the existence of the inverse isomorphism of ψ that we denote by ϕ in this proof:

$$\phi : \begin{array}{ccc} \text{Norm}(\mathcal{F}^s, \mathcal{F}^u) & \longrightarrow & \widetilde{\text{Centr}}(F) \\ \bar{G} & \longmapsto & G \end{array},$$

where G is the isotopy class of \bar{G} . There exists a nonzero integer k such that \bar{F}^k fixes all the separatrices.

Let us first show that ϕ is well-defined. For any diffeomorphism \bar{G} belonging to $\text{Norm}(\mathcal{F}^s, \mathcal{F}^u)$, $\bar{G}\bar{F}^k\bar{G}^{-1}\bar{F}^{-k}$ belongs to $\text{Norm}(\mathcal{F}^s, \mathcal{F}^u)$ and fixes all the separatrices. But since L is a homomorphism in \mathbb{R} , $L(\bar{G}\bar{F}^k\bar{G}^{-1}\bar{F}^{-k}) = 0$, so $\bar{G}\bar{F}^k\bar{G}^{-1}\bar{F}^{-k} = \text{Id}$. Hence \bar{G} commutes with \bar{F}^k , hence G belongs to $\widetilde{\text{Centr}}(F)$.

Let us show that the homomorphism ϕ is injective. For any diffeomorphism $\bar{A} \in \text{Ker}(\phi)$, \bar{A} is isotopic to the identity. Then \bar{A} preserves the isotopy class of curves, hence \bar{A} cannot be pseudo-Anosov, hence \bar{A} is a diffeomorphism of finite order, isotopic to the identity. According to [FLP], Expos 12, this implies that \bar{A} is the identity.

At last, let us show that the homomorphism ϕ is surjective. Let G be an element of $\widetilde{\text{Centr}}(F)$: there exists a nonzero integer ℓ such that G and F^ℓ commute. Let \bar{G}' be a representative of G in $\text{Diff}(\Sigma', \mathcal{P})$; then $\bar{G}'\bar{F}^\ell\bar{G}'^{-1}$ is isotopic to \bar{F}^ℓ , so according to Theorem III, Expos 12 in [FLP] (see also Theorem 2.14 in [BoPa]), there exists a diffeomorphism \bar{H} isotopic to the identity such that $\bar{H}\bar{G}'\bar{F}^\ell(\bar{H}\bar{G}')^{-1} = \bar{F}^\ell$. Let us set $\bar{G} = \bar{H}\bar{G}'$. We get then $\bar{G}\bar{F}^\ell\bar{G}^{-1} = \bar{F}^\ell$. Hence \bar{G} preserves the stable and unstable foliations of \bar{F}^ℓ , hence \bar{G} belongs to $\text{Norm}(\mathcal{F}^s, \mathcal{F}^u)$. Thus any G of $\widetilde{\text{Centr}}(F)$ has an preimage in $\text{Norm}(\mathcal{F}^s, \mathcal{F}^u)$. \square

We are now ready to prove Proposition ??.

Proposition ?? (Structure of $\widetilde{\text{Centr}}(F)$).

Let Σ be a connected surface without boundary and let F be a pseudo-Anosov mapping class in $\text{Mod}(\Sigma)$. There exists a surjective homomorphism $\ell_F : \widetilde{\text{Centr}}(F) \rightarrow \mathbb{Z}$ satisfying the following properties:

- (i) The kernel $\text{Ker}(\ell_F)$ coincides with the set of all the finite order mapping classes of $\widetilde{\text{Centr}}(F)$.

- (ii) The kernel $\text{Ker}(\ell_F)$ is a group of order smaller than or equal to $6|\chi(\Sigma)|$.
- (iii) The homomorphism ℓ_F does not depend on F , but only on $\widetilde{\text{Centr}}(F)$ up to the sign. If for two pseudo-Anosov F and F' there exist two positive integers p and q such that $F^p = F'^q$, then $\widetilde{\text{Centr}}(F) = \widetilde{\text{Centr}}(F')$ and $\ell_F = \ell_{F'}$.
- (iv) The group $\widetilde{\text{Centr}}(F)$ is a semi-direct product $\text{Per} \rtimes \mathbb{Z}$ where Per is a finite group isomorphic to $\text{Ker}(\ell_F)$. In particular, $\widetilde{\text{Centr}}(F)$ is virtually infinitely cyclic.

Proof. Let Σ be a surface without boundary. According to Proposition A.19, there exists an isomorphism $\psi : \widetilde{\text{Centr}}(F) \rightarrow \text{Norm}(\mathcal{F}^s, \mathcal{F}^u)$, $G \mapsto \bar{G}$, such that \bar{G} is a representative of G . Let ℓ_F be the homomorphism $L \circ \psi$, that we normalize, so that $\text{Im}(\ell_F) = \mathbb{Z}$. Let us prove items (i), (ii) and (iii).

(i) It is clear that for all $G \in \widetilde{\text{Centr}}(F)$, if $\ell_F(G) \neq 0$, then for all integers m different from 1, $\ell_F(G^m) \neq \ell_F(G)$, so G is not of finite order. In the contrary, $\text{Ker}(\ell_F)$ is equal to $\psi^{-1}(\text{Ker}(L))$ which is finite, so the elements of $\text{Ker}(\ell_F)$ are of finite order.

(ii) According to Proposition A.19, the homomorphism ψ is an isomorphism, so $\text{Ker}(\ell)$, which is equal to $\text{Ker}(L \circ \psi)$, is isomorphic to $\text{Ker}(L)$. Let us compute the cardinality of $\text{Ker}(L)$. According to Proposition A.18.(iv), we know it is finite.

Let us recall that all the indices of the singular points are greater than or equal to 3. We lean on Proposition A.17:

$$\chi(\Sigma) = \sum_{P \in \mathcal{S}} \left(1 - \frac{\text{Ind}(\mathcal{F}^s, \mathcal{F}^u : P)}{2} \right).$$

The surface Σ is of negative Euler characteristic, so the set of singular points is nonempty. Let X be the set of all the separatrices of \mathcal{F}^u . Let P be a singular point and let k be the index $\text{Ind}(\mathcal{F}^s, \mathcal{F}^u : P)$. The k separatrices ending at P bring together a $(1 - \frac{k}{2})$ -contribution to the Euler characteristic of Σ , so each of them bring a contribution of $\frac{1}{k} - \frac{1}{2}$. Since $k \geq 3$, the contribution per separatrix ending at P to the Euler characteristic of Σ is smaller than or equal to $-\frac{1}{6}$. This is also true for all the separatrices of \mathcal{F}^u , so the cardinality of X , the set of separatrices of \mathcal{F}^u , must equal at most $6|\chi(\Sigma)|$. Now the action of $\text{Ker}(L)$ on X is free according to Proposition A.18.(iii), so the cardinality of $\text{Ker}(L)$ is smaller than or equal to the cardinality of X , whence:

$$|\text{Ker}(L)| \leq 6|\chi(\Sigma)|.$$

But $\text{Ker}(L)$ is isomorphic to $\text{Ker}(\ell_F)$ via ψ , so:

$$|\text{Ker}(\ell_F)| \leq 6|\chi(\Sigma)|.$$

(iii) Let G be a pseudo-Anosov mapping class such that $\widetilde{\text{Centr}}(G) = \widetilde{\text{Centr}}(F)$ and let ℓ_G and ℓ_F be the two homomorphisms associated to G and F . The periodic elements of $\widetilde{\text{Centr}}(G)$ and $\widetilde{\text{Centr}}(F)$ are the same, so $\text{Ker}(\ell_G) = \text{Ker}(\ell_F)$. Hence we have the following commutative diagram where the lines are exact and the vertical full arrows are equalities. It follows that the dotted arrow is an isomorphism.

$$\begin{array}{ccccccc} 1 & \longrightarrow & \text{Ker}(\ell_G) & \longrightarrow & \widetilde{\text{Centr}}(G) & \xrightarrow{\ell_G} & \mathbb{Z} \longrightarrow 1 \\ & & \downarrow = & & \downarrow = & & \vdots \\ 1 & \longrightarrow & \text{Ker}(\ell_F) & \longrightarrow & \widetilde{\text{Centr}}(F) & \xrightarrow{\ell_F} & \mathbb{Z} \longrightarrow 1 \end{array}$$

But ℓ_F (respectively ℓ_G) is the quotient map $\widetilde{\text{Centr}}(G) \rightarrow \widetilde{\text{Centr}}(G)/\text{Ker}(\ell_G) \cong \mathbb{Z}$ (resp. $\widetilde{\text{Centr}}(F) \rightarrow \widetilde{\text{Centr}}(F)/\text{Ker}(\ell_F) \cong \mathbb{Z}$). Hence ℓ_G and ℓ_F coincide up to an isomorphism of \mathbb{Z} , so ℓ_F and ℓ_G are equal up to multiplication by -1 .

Let F and F' be two pseudo-Anosov mapping classes such that there exist two positive integers p and q such that $F^p = F'^q$, let ℓ_F and $\ell_{F'}$ be the two homomorphisms associated to F and F' . Since $F^p = F'^q$, we have $\widetilde{\text{Centr}}(F) = \widetilde{\text{Centr}}(F')$, so according to what precedes, $\ell = \ell'$ or $\ell = -\ell'$. Let u and v be two positive integers such that $\ell_F(F) = u$ and $\ell_{F'}(F') = v$. Then $\ell_F(F^p) = pu$ and $\ell_{F'}(F^p) = \ell_{F'}(F'^q) = qv$, so $\ell_F(F^p)$ and $\ell_{F'}(F^p)$ have the same sign, hence $\ell_F = \ell_{F'}$.

(iv) Let M be a mapping class of $\widetilde{\text{Centr}}(F)$ such that $\ell(M) = 1$. Then the quotient set $\widetilde{\text{Centr}}(F)/\langle M \rangle$ is in bijection with $\text{Ker}(\ell)$, so we have $[\widetilde{\text{Centr}}(F) : \langle M \rangle] = |\text{Ker}(\ell)|$. Thus $\langle M \rangle$ is an infinite cyclic subgroup of finite index of $\widetilde{\text{Centr}}(F)$. Moreover, the exact sequence

$$1 \rightarrow \text{Per} \xrightarrow{\text{incl.}} \widetilde{\text{Centr}}(F) \xrightarrow{\ell_F} \mathbb{Z} \rightarrow 1$$

is split since the last but one term of the sequence is \mathbb{Z} . So $\widetilde{\text{Centr}}(F)$ is a semi-direct product. This is a direct product if and only if there exists a pseudo-Anosov mapping class belonging to $\ell_F^{-1}(\{1\})$, whose action on the separatrices is trivial. \square

A.5 Reducible mapping classes, Thurston's theory and the canonical reduction system

Lemma A.20 (Canonical reduction system on subsurfaces).

Let Σ be a surface and Σ' be a subsurface of Σ non-homeomorphic to a pair of pants. Let F be a mapping class of $\text{Mod}(\Sigma)$ that preserves Σ' and let F' in $\text{Mod}(\Sigma')$ be the restriction of F to Σ' .

- (i) If there exists a reduction curve of F in $\text{Curv}(\Sigma)$ that is not included in $\Sigma \setminus \Sigma'$, then there exists a reduction curve of a nonzero power of F' in $\text{Curv}(\Sigma')$.
- (ii) Let x be a curve belonging to $\text{Curv}(\Sigma')$. If there exists a reduction curve of F in $\text{Curv}(\Sigma)$ that intersects x , then there exists a reduction curve of a nonzero power of F' in $\text{Curv}(\Sigma')$ that intersects x .
- (iii) Any curve of $\sigma(F)$ non-isotopic to a boundary component of Σ' is included either in Σ' or in $\Sigma \setminus \Sigma'$.
- (iv) Moreover, $\sigma(F') = \sigma(F) \cap \text{Curv}(\Sigma')$.

Proof. Item (ii) implies item (i): it is indeed enough to choose a curve x in Σ' that intersects a reduction curve of F . Then, according to item (ii), there exists a reduction curve of F' included in Σ' .

Let us show item (ii). Let x be a reduction curve of $\text{Curv}(\Sigma')$, let c be a reduction curve of F that intersects x . We are going to show that there exists a reduction curve c' of F' that intersects x .

If c is included in Σ' , there is nothing to be shown. Let us now assume that c is not included in Σ' . As the curve c intersects the curve x , which is included in Σ' , then c must intersect $\partial\Sigma'$. Consequently, the intersection $c \cap \Sigma'$ consists in a finite nonzero number of paths with extremities

in $\partial\Sigma'$. Then there exists a nonzero integer m such that F^m preserves each boundary of Σ' and preserves each connected component of $c \cap \Sigma'$. Since $I(c, x) \neq 0$, at least one of these paths cuts the curve x . Let us choose one such path which we call d . The extremities of d lie in one or two boundary components of Σ' . In both cases, let P be the pair of pants corresponding to the intersection of Σ' with the tubular neighbourhood of the union of d and the boundary components of Σ' containing the extremities of d (darkened in Figures 45 and 46). Then F^{2m} preserves each boundary component of P . Notice that no boundary component of P can bound any disk:

- if P has only one boundary component a in $\partial\Sigma'$, then both of the other boundary components are isotopic to the union of a path included in a and a path included in d , but a and d do not cobound any bigon, so both boundary components of P different from a cannot bound any disk;

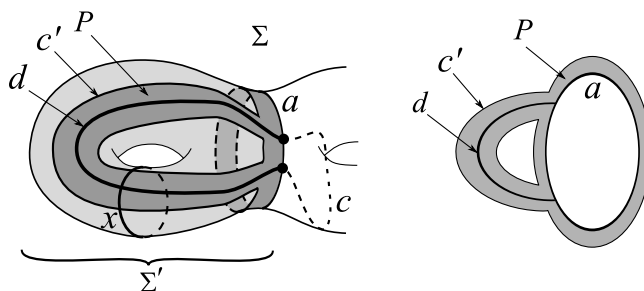

Figure 45: The pair of pants P in Σ' , when both extremities of d belong to the same boundary a of Σ' .

- and if P has two boundary components in $\partial\Sigma'$, both of these boundary components do not bound any disk. Moreover, as they are not isotopic in Σ , they do not cobound any cylinder. So the third boundary component of P cannot bound any disk.

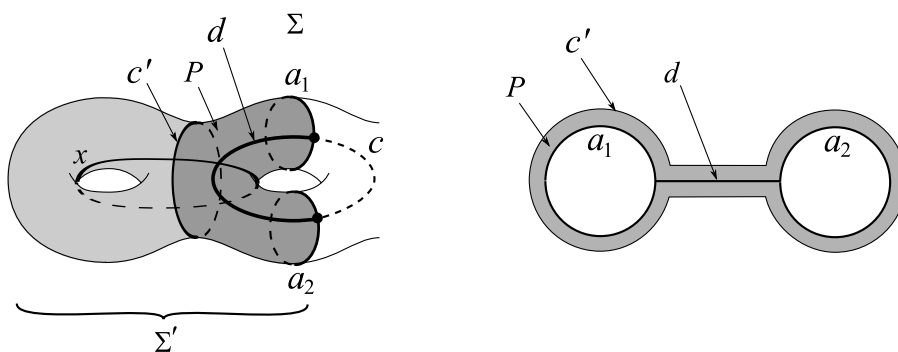

Figure 46: The pair of pants P in Σ' when both extremities of d belong to two distinct boundary components a_1 and a_2 of Σ' .

Notice also that the curve x cannot be one of the boundary components of P , for x and d intersect. The curve x cannot be included in P for any curve that is included in a pair of pants is isotopic to one of its boundary components. Consequently, there exists a boundary of P ,

say c' , that intersects x . This boundary c' cannot be a boundary component of Σ' because the boundary components of Σ' do not intersect x . Hence c' belongs to $\mathcal{C}\text{urv}(\Sigma')$, is stable by F^{2m} , so is stable by $(F')^{2m}$, and intersects the curve x . We have proved item (ii).

Let us show item (iii). The mapping class F preserves Σ' , so $F(\text{Bndy}(\Sigma')) = \text{Bndy}(\Sigma')$, so the curves of $\text{Bndy}(\Sigma')$ are reduction curves of F . But no curve of $\sigma(F)$ intersects any reduction curve of F , hence any curve of $\sigma(F)$ that is not isotopic to a boundary component of Σ' is included either in Σ' or in $\Sigma \setminus \Sigma'$.

Let us show item (iv). Let x be a reduction curve of F' . If x is not an essential reduction curve of F , then there exists a reduction curve c of F in $\mathcal{C}\text{urv}(\Sigma)$ that intersects x . Then according to item (ii), there exists a nonzero integer m and a reduction curve c' of $(F')^m$ in $\mathcal{C}\text{urv}(\Sigma')$ that intersects x . Hence x is not an essential reduction curve of $(F')^m$. But $\sigma(F') = \sigma((F')^m)$, so x is not an essential reduction curve of F' . In other words, we have $\sigma(F') \subset \sigma(F) \cap \mathcal{C}\text{urv}(\Sigma')$. The converse inclusion is obvious: if a curve belongs to $\sigma(F)$, it belongs *a fortiori* to $\sigma(F')$. \square

Lemma A.21 (Characterization of the essential reduction curves).

Let Σ be a surface and let F be a mapping class in $\text{Mod}(\Sigma)$. Let a be an oriented curve such that F preserves a and its orientation. Then, there exist two connected subsurfaces S_1 and S_2 (they may be equal) in Σ such that:

- the curve a bounds S_1 (respectively S_2) on the left (rep. on the right),
- both surfaces S_1 and S_2 are stable by F ,
- for all $i \in \{1, 2\}$, the mapping class induced by F in $\text{Mod}(S_i)$, denoted by $F|_{S_i}$, is either periodic or pseudo-Anosov.

Let us denote by S_{12} the union of S_1 and S_2 along a . Let us denote by $F|_{S_{12}}$ the mapping class induced by F in $\text{Mod}(S_{12})$. Then a belongs to $\sigma(F)$ if and only if we are in one of the three following cases:

- a) $F|_{S_1}$ or $F|_{S_2}$ is pseudo-Anosov;
- b) $F|_{S_1}$ and $F|_{S_2}$ are both periodic of the same order $m \geq 1$, and $F^m|_{S_{12}}$ is a nontrivial power of a Dehn twist along the curve a ;
- c) $F|_{S_1}$ and $F|_{S_2}$ are periodic with orders m_1 and m_2 respectively such that $m_1 \neq m_2$.

Proof. Let Γ be the set of curves $\sigma(F) \cup \{a\}$. Let us give to a an orientation and let us denote by S_1 (respectively S_2) the connected component of Σ_Γ bounding a on the left (resp. on the right). For all $i \in \{1, 2\}$, notice that $\sigma(F|_{S_i}) = \emptyset$, so $F|_{S_i}$ is either pseudo-Anosov, or periodic. Moreover, the surface S_{12} cannot be a pair of pants, so there exist some curves in $\mathcal{C}\text{urv}(S_{12})$ that intersect a .

Let us show first that if a belongs to $\sigma(F)$, then one of the cases a), b) or c) is satisfied. The cases a), b), c) describe all the possible cases except the one where $F|_{S_1}$ and $F|_{S_2}$ are both periodic of order $m \geq 1$ and where $F^m|_{S_{12}}$ coincides with the identity. Let c be a curve of $\mathcal{C}\text{urv}(S_{12})$ which intersects a . But this curve c is preserved by F^m , so c is a reduction curve of F^m . Therefore a cannot belong to $\sigma(F^m)$. So a does not belong to $\sigma(F)$.

Conversely, let us show now that each case a), b), or c) implies that $a \in \sigma(F)$ (or that there exists a nonzero integer p such that $a \in \sigma(F^p)$, which is equivalent).

In the case a), let us denote by Σ' the subsurface S_1 or S_2 on which F induces a pseudo-Anosov mapping class. Then Σ' is not a pair of pants. If there existed a reduction curve c of F that intersected a , it would not be included in $\Sigma \setminus \Sigma'$, so we could apply item (i) of Lemma A.20: there would exist a reduction curve c' of a nonzero power of F that would be included in Σ' (cf. Figure 47). This is absurd for the restriction of F (and of its nonzero powers) to Σ' is pseudo-Anosov. Hence any curve c of $\mathcal{C}urv(\Sigma)$ such that $I(a, c) \neq 0$ is not a reduction curve of F , so the reduction curve a of F is an essential reduction curve of F .

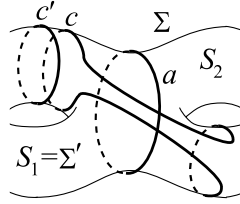

Figure 47: Description of the case a) in the proof of Lemma A.21.

In the case b), there exists a nonzero integer ℓ such that $(F|_{S_{12}})^m = T_a^\ell$. But then for any integer p and any curve c in $\mathcal{C}urv(S_{12})$ intersecting a , applying the famous intersection formula between a curve and its image by the power of a Dehn twist (cf. [FLP]), we have:

$$I((F|_{S_{12}})^{mp}(c), c) = I(T_a^{\ell p}(c), c) = |\ell p| I(a, c)^2 \neq 0.$$

Hence no curve c that intersect a can be preserved by some power of $(F|_{S_{12}})^m$, hence a belongs to $\sigma((F|_{S_{12}})^m)$. Hence a belongs to $\sigma(F^m)$ according to item (iv) of Lemma A.20.

In the case c), S_1 and S_2 cannot be equal. For all $i \in \{1, 2\}$, let $\mathcal{M}od(S_i, a)$ be the set of isotopy classes of diffeomorphisms of S_i fixing (a representative of) the curve a pointwise, and let F_i be a mapping class in $\mathcal{M}od(S_i, a)$ such that F_i induces the mapping class $F|_{S_i}$ in $\mathcal{M}od(S_i)$. Let us introduce some notation:

- For two integers k and ℓ , let us denote their greatest common divisor by $k \wedge \ell$ and their least common multiple by $k \vee \ell$.
- For all $i \in \{1, 2\}$, let d_i be an integer such that $F_i^{m_i} = T_a^{d_i}$ with $d_i \wedge m_i = 1$ according to Lemma A.14.
- Let us set $m'_1 = \frac{m_1}{m_1 \wedge m_2} = \frac{m_1 \vee m_2}{m_2}$.
- Let us set $m'_2 = \frac{m_2}{m_1 \wedge m_2} = \frac{m_1 \vee m_2}{m_1}$; thus, m'_1 and m'_2 are coprime.

Then for all $i \in \{1, 2\}$, we have

$$F_i^{(m_1 \vee m_2)} = T_a^{\left(\frac{m_1 \vee m_2}{m_i} d_i\right)} = T_a^{m'_{(3-i)} d_i}.$$

Hence there exists an integer q such that:

$$(F|_{S_{12}})^{(m_1 \vee m_2)} = T_a^{(m'_2 d_1 + m'_1 d_2)} T_a^{q(m_1 \vee m_2)}.$$

Since m_1 and m_2 are different, one of them, by instance m_2 , is not equal to $m_1 \vee m_2$, so m'_1 is different from 1. But d_1 and m'_2 are both coprime with m'_1 , so $m'_2 d_1$ is coprime with

m'_1 . Now m'_1 divides $m'_1 d_2 + q(m_1 \vee m_2)$, so m'_1 is coprime with $m'_2 d_1 + m'_1 d_2 + q(m_1 \vee m_2)$, so $m'_2 d_1 + m'_1 d_2 + q(m_1 \vee m_2)$ is nonzero. Hence $(F|_{S_{12}})^{(m_1 \vee m_2)}$ is a nonzero power of T_a . Thus, if we set $p = (m_1 \vee m_2)$ and if we consider F^p instead of F , then we are back to the case b) with $m = 1$. \square

As a corollary, we establish a link between the canonical reduction systems of F , G and FG , assuming that F and G are two commuting mapping classes.

Proposition A.22. *Let F and G be two commuting mapping classes. Then,*

$$\sigma(FG) \subset \sigma(F) \cup \sigma(G).$$

Proof. Let a be a curve belonging to $\sigma(FG)$. Since FG commutes with F and with G , we have $I(a, \sigma(F) \cup \sigma(G)) = 0$. Let us set $\mathcal{A} = \sigma(F) \cup \sigma(G)$. Let us assume that a does not belong to \mathcal{A} and let us show that this is absurd.

Let m be a nonzero integer such that F^m and G^m preserve each subsurface in $\text{Sub}_{\mathcal{A}}(\Sigma)$. According to Lemma A.20.(iv), the restrictions of the mapping classes induced by F and G on each subsurface in $\text{Sub}_{\mathcal{A}}(\Sigma)$ have empty canonical reduction systems, so they are either pseudo-Anosov or periodic. We can even assume that they are either pseudo-Anosov or the identity mapping class, provided that the integer m is large enough.

Since a does not belong to \mathcal{A} although $I(a, \mathcal{A}) = 0$, there exists a subsurface S belonging to $\text{Sub}_{\mathcal{A}}(\Sigma)$ such that a is included in S . Since F and G commute with FG , they preserve $\sigma(FG)$, so we can assume that F^m and G^m preserve a , even if it means multiplying m by some positive integer. Therefore a is a reduction curve of F^m and G^m . So the restrictions of F^m and G^m to S cannot be pseudo-Anosov, so they are the identity mapping class. Hence the restriction of $(FG)^m$ to S is equal to the identity mapping class, hence according to Lemma A.21, the reduction curve a of FG cannot be essential. This is the expected contradiction. \square

References

- [ArYo] P. Arnoux, J.-C. Yoccoz. *Construction de difféomorphismes pseudo-Anosov* C. R. Acad. Sci. Paris Sr. I Math. (1) **292** (1981), 75-78.
- [At1] E. Artin, *Theorie der Zöpfe*, Abhandlungen Hamburg **4** (1925), 47-72, (JMF 51.0450.01).
- [At2] E. Artin. *Theory of braids*, Annals of Math. (2) **48** (1947), 101-126.
- [At3] E. Artin, *Braids and permutations*, Annals of Math. (2) **48** (1947), 643-649.
- [BeMa] R. Bell, D. Margalit, *Braid groups and the co-Hopfian property*, Journal of Algebra **303** (2006), 275-294.
- [BkMt] J. Berrick, M. Matthey *Stable classical groups and strongly torsion generated groups*, Comment. Math. Helv. **84** (2009), 909-928.
- [Bi] J. Birman, *Braids, Links and Mapping Class Groups*, Annals of Mathematics Studies, Princeton University Press **82** (1975), Princeton.
- [BiBr] J. Birman, T. Brendel, *Braids: A survey*, in Handbook of Knot Theory (Ed. W. Menasco and T. Thistlethwaite) (2005), Elsevier.

- [BiHi] J. Birman, H. Hilden, *On isotopies of homeomorphisms of Riemann surfaces*, Annals of Math. (2) **97** (1973), 424-439.
- [BiLuMc] J. Birman, A. Lubotzky, J. McCarthy, *Abelian and Solvable Subgroups of the Mapping Class Group*, Duke Mathematical Journal (4) **50** (1983), 1007-1020.
- [Bk] N. Bourbaki, *Groupes et algèbres de Lie*, chapters 4, 5 et 6, Hermann, Paris, 1968.
- [BiCa] S.A. Bleiler, A.J. Casson, *Automorphisms of surfaces after Nielsen and Thurston*, London Mathematical Society Students Texts **9** (1988), Cambridge University Press, Cambridge.
- [BoPa] C. Bonatti, L. Paris, *Roots in the mapping class groups*, Proc. Lond. Math. Soc. (Third Series) (2) **98** (2009), 471-503.
- [Bri] E. Brieskorn, *Sur les groupes de tresses (d'après V.I. Arnold)*, Sminaire Bourbaki, 24ème annee (1971/72), Exp. **401**, Lecture Notes Math. **317**, Springer, Berlin Heidelberg New York, (1973) 1-24.
- [BriSa] E. Brieskorn, K. Saito, *Artin Gruppen und Coxeter-Gruppen*, Invent. Math. **17** (1972), 245-271.
- [Bro] L.E.J. Brouwer, *ber die periodischen Transformationen der Kugel*, Math. Ann. **80** (1919), 39-41.
- [Ch1] R. Charney, *Artin groups of finite type are biautomatic*, Math. Ann. **292** (1992), 671-683.
- [Ch2] R. Charney, *Geodesic automation and growth functions for Artin groups of finite type*, Math. Ann. **301** (1995), 307-324.
- [ChCr] R. Charney, J. Crisp, *Automorphism groups of some affine and finite type Artin groups*, Mathematical Research Letters **12** (2005), 321-333.
- [CoPa] A.M. Cohen, L. Paris, *On a theorem of Artin*, J. Group Theory **6** (2003), 421-441.
- [CrPa1] J. Crisp, L. Paris, *The solution to a conjecture of Tits on subgroups generated by the squares of the generators of an Artin group*, Inventiones mathematicae **145** (2001), 19-36.
- [CrPa2] J. Crisp, L. Paris, *Artin groups of type B and D*, Advances in Geometry **5** (2005), 607-636.
- [Ct] F. Castel, *Geometric representation of the Braid groups*, translation of the author's PhD. thesis in English, available on Archiv.
- [Cx] H.S.M. Coxeter. *The complete enumeration of finite groups of the form $R_i^2 = (R_i R_j)^{k_{ij}} = 1$* , J. London Math. Soc. **10** (1935), 21-25.
- [De1] M. Dehn, *On curve systems on two-sided surfaces, with application to the mapping problem*, Lecture (supplemented) to the math. colloquium, Breslau 11-2-1922, translated in English in [De3], 234-252.
- [De2] M. Dehn, *Die Gruppe der Abbildungsklassen*, Acta Math. **69**, 135-206; translated in English in [De3], 256-362.
- [De3] M. Dehn, *Papers in Group Theory and Topology*, Springer-Verlag, New York (1987), translated from the German and introduced by John Stillwell.
- [Dl] P. Deligne, *Les immeubles des groupes de tresses generalises*, Invent. Math. **17** (1972), 273-302.

- [DyGr] J.L.Dyer, E.K. Grossman. *The automorphism groups of the braid groups*, Amer. J. Math. (6) **103** (1981), 1151-1169.
- [Ei] S. Eilenberg, *Sur les transformations périodiques de la surface de sphère*, Fund. Math. **22** (1934), 28-41.
- [Ep] D.B.A. Epstein, *Curves on 2-manifolds and isotopies*, Acta Math. **115** (1966), 83-107.
- [Fa] B. Farb, *Problems on Mapping Class Groups and Related Topics*, Proceedings of Symposia in Pure Mathematics **74** (2006), American Mathematical Society, AMS Bookstore.
- [FaMa] B. Farb, D. Margalit *A Primer on Mapping Class Group*, version 3.1 (June 2009) is available on the web page: <http://www.math.uchicago.edu/~margalit/mcg/mcgv31.pdf>
- [FdNe] E. Fadell, L. Neuwirth, *Configuration spaces*, Math. Scand. **10** (1962), 111-118.
- [FLP] A. Fathi, F. Laudenbach, V. Ponaru, *Travaux de Thurston sur les surfaces*, Sminaire Orsay, Astrisque **66** et **67** (1979), Socit Mathématique de France, Paris.
- [Hi] Morris W. Hirsch, *Differential topology*, Graduate texts in Mathematics **33** (1976), Springer-Verlag, New York Inc.
- [Hu] J.E. Humphreys, *Reflection groups and Coxeter groups*, Cambridge Studies in Advanced Mathematics **29** (1990), Cambridge University Press, Cambridge.
- [Hv1] W.J. Harvey, *Geometric structure of surface mapping class groups*, Homological group theory (Proc. Durham, 1977), London Math.Soc. Lecture Note Ser. **36** (1979), 255-269, Cambridge Univ. Press, Cambridge New York.
- [Hv2] W.J. Harvey, *Boundary structure of the modular group*, in *Riemann surfaces and related topics: Proceedings of the 1978 Stony Brook Conference*, edited by I. Kra and B. Maskit, Annals of Math. Studies **97** (1981), Princeton University Press, 245-251.
- [HvKo] W.J. Harvey, M. Korkmaz *Homomorphisms from mapping class groups*, Bull. London Math. Soc. **37** (2005), 275-284.
- [HtTh] A. Hatcher, W. Thurston, *A presentation for the mapping class group of a closed orientable surface*, Topology (3) **19** (1980), 221-237.
- [Iv1] N.V. Ivanov, *Automorphisms of Teichmüller modular groups*, Lecture Notes in Math., **1346** (1988), Springer-Verlag, Berlin and New York, 199270.
- [Iv2] N.V. Ivanov, *Subgroups of Teichmüller Modular Groups*, translated from the Russian by E.J.F. Primrose, Translations of Mathematical Monographs **115** (1992), American Mathematical Society, Providence, RI.
- [Iv3] N.V. Ivanov, *Automorphisms of complexes of curves and of Teichmüller Spaces*, Math. Res. Notices **14** (1997), 651-666; also in: *Progress in knot theory and related topics*, Travaux en cours **56** (1997), Hermann, Paris, 113-120.
- [IvMc] N.V. Ivanov, J. McCarthy, *On injective homomorphisms between Teichmüller Modular Groups I*, Inventiones mathematicae **135** (1999), 425-486, Springer-Verlag.
- [J] D. Johnson, *The structure of Torelli group I: A finite set of generators for \mathcal{I}* , Annals of Mathematics **118** (1983), 423-442.
- [KaTu] C. Kassel, V. Turaev, *Braid groups*, Graduate Texts in Mathematics, **247** (2008), Springer, New York.

- [Ke1] S.P. Kerckhoff, *The Nielsen realisation problem*, Bull. AMS (3) **2** (1980), 452-454.
- [Ke2] S.P. Kerckhoff, *The Nielsen realisation problem*, Ann. of math. (2), **117** (1983), 235-265.
- [Kj] B. de Kerkjartò. *ber die periodischen Transformationen der Kreisscheibe und der Kugelflche*, Math. Annalen **80** (1919), 3-7.
- [Ko1] M. Korkmaz, *Automorphisms of complexes of curves on punctured spheres and on punctured tori*, Topology and its Applications (2) **95** (1999), 85-111.
- [Ko2] M. Korkmaz, *Low-dimensional homology groups of mapping class groups: a survey*, Turkish Journal of Mathematics (1) **26**, (2002).
- [LaPa] C. Labrure, L. Paris, *Presentations for the punctured mapping class groups in terms of Artin groups*, Algebr. Geom. Topol. **1** (2001), 73-114.
- [Le] H. Van der Leek, *The Homotopy Type of Complex Hyperplane Complements*, Ph.D. Thesis, Utrecht (1994).
- [Lk] W.B.R. Lickorish, *A finite set of generators for the homeotopy group of a 2-manifold*, Proc. Cambridge Philos. Soc., **60** (1964), 769-778.
- [Ln1] V. Lin, *Artin braids and the groups and spaces connected with them*, Plenum Publishing Corporation (1982), 736-788.
- [Ln2] V. Lin, *Braids and Permutations*, arXiv:math.GR/0404528 v1, 29 Apr 2004.
- [Lu] F. Luo, *Automorphisms of complexes of curves*, Topology (2) **39** (2000), 283-298.
- [Mc1] J.D. McCarthy, *Automorphisms of surface mapping class groups. A recent theorem of N. Ivanov*, Invent. Math. **84** (1986), 49-71.
- [Mc2] J.D. McCarthy, *Normalizers and Centralizers of pseudo-Anosov mapping classes*, Preprint, 1982 (This constitutes a part of the author's Ph. D thesis in Columbia University).
- [McPp] J.D. McCarthy, A. Papadopoulos *Automorphisms of the complex of domains*, preprint, Max-Planck Institut, Bonn (2006).
- [Ni1] J. Nielsen, *Untersuchungen zur Theorie der geschlossenen zweiseitigen Flchen I*, Acta Math. **50** (1927), 189-358.
- [Ni2] J. Nielsen, *Untersuchungen zur Theorie der geschlossenen zweiseitigen Flchen II*, Acta Math. **53** (1929), 1-76.
- [Ni3] J. Nielsen, *Untersuchungen zur Theorie der geschlossenen zweiseitigen Flchen III*, Acta Math. V. **58** (1932), 87-167.
- [Ni4] J. Nielsen, *Abbildungsklassen endlicher Ordnung*, [J] Acta Math. **73** (1942), 23-115, [ISSN 0001-5962].
- [Pa1] L. Paris, *Parabolic subgroups of Artin groups*, J. Algebra **196** (1997), 369-399.
- [Pa2] L. Paris, *From braid groups to mapping class groups*, Proceedings of Symposia in Pure Mathematics **74** (2006), Amer. Math. Soc., Providence, RI, 355-371
- [PaRo] L. Paris, D. Rolfsen, *Geometric subgroups of mapping class groups*, Journal fr die reine und angewandte Mathematik **521** (2000), 47-83, Walter de Gruyter, Berlin-New York.
- [PeV] B. Perron, J.P. Vannier, *Groupe de monodromie gomtrique des singularits simples*, Mathematische Annalen **306** (1996), 231-245, Springer-Verlag.
- [Ro] D. Rolfsen, *Knots and links*, Publish or Perish, Berkeley 1976.

- [Se] V. Sergiescu, *Graphes planaires et presentations des groupes de tresses*, Mathematische Zeitschrift, vol. **214** (1993), 477-490, Springer-Verlag.
- [Th] W.P. Thurston, *On the geometry and dynamics of surfaces.*, Bull. Amer. Math. Soc. (N.S.) (2) **19** (1988), 417-431.
- [Ti] J. Tits, *Normalisateurs de tores. I. Groupes de Coxeter tendus*, J. Algebra vol **4** (1966), 96-116.
- [VL] H. Van der Lek, *The homotopy type of complex hyperplane complements*, Ph. D. Thesis, Nijmegen, 1983.
- [W] B. Wajnryb, *Artin groups and geometric monodromy*, Invent. Math. **138** (1999), 563-571.