



**HAL**  
open science

## Strategic Technology Alignment Roadmapping STAR® Aligning R&D Investments with Business Needs

N N Z Gindy, Maged S Morcos, Bülent Cerit, Allan Hodgson

► **To cite this version:**

N N Z Gindy, Maged S Morcos, Bülent Cerit, Allan Hodgson. Strategic Technology Alignment Roadmapping STAR® Aligning R&D Investments with Business Needs. International Journal of Computer Integrated Manufacturing, 2008, 21 (08), pp.957-970. 10.1080/09511920801927148 . hal-00582318

**HAL Id: hal-00582318**

**<https://hal.science/hal-00582318>**

Submitted on 1 Apr 2011

**HAL** is a multi-disciplinary open access archive for the deposit and dissemination of scientific research documents, whether they are published or not. The documents may come from teaching and research institutions in France or abroad, or from public or private research centers.

L'archive ouverte pluridisciplinaire **HAL**, est destinée au dépôt et à la diffusion de documents scientifiques de niveau recherche, publiés ou non, émanant des établissements d'enseignement et de recherche français ou étrangers, des laboratoires publics ou privés.



**Strategic Technology Alignment Roadmapping STAR®  
Aligning R&D Investments with Business Needs**

Journal:	<i>International Journal of Computer Integrated Manufacturing</i>
Manuscript ID:	TCIM-2007-IJCIM-0044.R2
Manuscript Type:	Original Manuscript
Date Submitted by the Author:	30-Nov-2007
Complete List of Authors:	Gindy, N N Z; The University of Nottingham, School of Mechanical, Material and Manufacturing Engineering Morcos, Maged; The University of Nottingham, School of Mechanical, Material and Manufacturing Engineering Cerit, Bülent; The University of Nottingham, School of Mechanical, Material and Manufacturing Engineering Hodgson, Allan; The University of Nottingham, School of Mechanical, Material and Manufacturing Engineering
Keywords:	ADVANCED MANUFACTURING TECHNOLOGY, TECHNOLOGY MANAGEMENT
Keywords (user):	Technology roadmapping, requirements capture; R&D; strategic technology alignment; portfolio balancing



# Strategic Technology Alignment Roadmapping STAR<sup>®</sup>

## Aligning R&D Investments with Business Needs

Gindy\*, N., Morcos\*\*, M, Cerit\*, B and Hodgson\*, A

\* School of Mechanical, materials and manufacturing Engineering  
University of Nottingham  
University Park  
NG7 2RD

**Professor Nabil Gindy**

[nabil.gindy@nottingham.ac.uk](mailto:nabil.gindy@nottingham.ac.uk)

Tel: +44-0-1159514069

Fax: +44-001159514140

**Dr. Maged Morcos \*\* Corresponding author for the IJCIM**

[maged.morcos@nottingham.ac.uk](mailto:maged.morcos@nottingham.ac.uk)

Tel: +44-0-1159514066

Fax: +44-001159514140

**Dr. Bulent Cerit**

[bulent.cerit@nottingham.ac.uk](mailto:bulent.cerit@nottingham.ac.uk)

Tel: +44-0-1159514061

Fax: +44-001159514140

**Mr. Allan Hodgson**

[allan.hodgson@nottingham.ac.uk](mailto:allan.hodgson@nottingham.ac.uk)

Tel: +44-0-1159514061

Fax: +44-001159514140

**Abstract**

The objective of the integrated technology roadmapping methodology STAR<sup>®</sup> outlined in this paper is to enable companies to align their technology acquisition programmes to meet their business objectives. STAR<sup>®</sup> has three phases – a preliminary phase involving the setting up of an enterprise framework, a technology data collection phase, and a project creation and assessment phase. STAR<sup>®</sup> utilises the analytic hierarchy process to rank company technology requirements, several non-financial factors to determine the alignment of proposed projects and visual representations to select a portfolio of projects. Project evaluations have demonstrated that statistically significantly different project selection outcomes arise from the additional non-financial factors included in STAR<sup>®</sup>.

Elements of STAR<sup>®</sup> are being implemented at a major collaborator, and it is planned to implement the whole STAR<sup>®</sup> methodology within a year. An integrated enterprise level roadmapping methodology such as STAR<sup>®</sup> offers an objective way of selecting and evaluating projects and, later, of re-evaluating and improving the process.

**Keywords:**

Technology roadmapping; requirements capture; R&D; strategic technology alignment; portfolio balancing

## 1 Introduction

Today's high technology manufacturing companies face an array of challenges arising from accelerating rates of technological change, globalisation of suppliers, competitors and markets and increasing customer expectations (Conger & Chiavetta 2006). These challenges drive manufacturing companies to be more flexible and responsive in the integrated development and manufacture of innovative products; a more rapid and balanced response to the predictable and unpredictable changes of the manufacturing environment plays an important role in the long term success of companies (Gindy & Saad 1997).

The European Institute of Technology Management (EITM) defines technology management as the "...effective identification, selection, acquisition, development, exploitation and protection of technologies (product, process and infrastructure) which are needed to maintain a market position and business performance in accordance with the company's objectives". The acquisition of appropriate technologies to enable the development and manufacture of innovative products is of primary importance in enabling a competitive advantage to be gained (Bucher 2003; Narayanan & Jayaraman 1997; Phaal, Farrukh, & Probert 2001).

Scott (Scott, 2001) carried out an international survey to investigate the problems that companies face in the current business environment. Ten key problems were identified, of which five related directly to technology issues. 'Strategic planning for technology products' was identified as the most important of these ten key issues, followed by 'new product project selection'.

Technology roadmapping is gaining increased recognition in industry as a flexible technology management tool for supporting businesses and improving their technology management processes through activities such as technology forecasting and technology planning (Bucher 2003; Farrukh, Phaal & Probert 2002; Grossman 2004; Phaal, Farrukh & Probert 2004a).

At the enterprise level, technology roadmapping is primarily a management tool to improve the enterprise's strategic technology planning processes by aligning technology acquisition to company strategic objectives derived from market and business drivers. In addition, the team-orientated technology roadmapping process also supports consensus building.

## **2 Background and state-of-the-art**

Technology roadmapping began as an approach developed and applied by industrial practitioners, and more recently became a focus of academic research. Technology roadmapping is now used at all levels in the global economy and can be used to co-ordinate science and technology developments at the international region or country level (e.g. European Union, USA, Canada, Japan), at the industrial sector level (e.g. semiconductor electronics), in multinational companies or at single-site enterprises.

Examples of roadmapping at the country level include the UK Foresight activities (Miles 2005), Canada (Industry Canada 2000), USA (Wagner & Popper 2003). At the regional level, the European Union has developed roadmaps, based on the European Technology Platforms, as the basis for planning and encouraging

collaborative long-term research and development; see (I\*PROMS 2006) and (ETN-SEE 2006) for examples of such roadmaps. At the industrial level, the most successful example of a long term roadmapping activity is the International Technology Roadmap for Semiconductors (SIA 1999). Scenario planning (Ringland 1998) is a useful adjunct to national, international and industrial level roadmapping, as it encourages practitioners to consider not only the most likely futures, but also extreme futures. For example, the automotive industry should be aware of potential futures with major hydrocarbon shortages, or with international legislation that drastically reduces allowable carbon dioxide emissions.

The above roadmaps do not take into account the strengths and weaknesses of an individual enterprise, and it is at the enterprise level that we are seeing the most rapid developments in roadmapping. The earliest exponent, and still one of the leading users of technology roadmapping at the enterprise and supply chain level is Motorola. Faced with increasing product complexity and technical change rate, Motorola introduced its original paper-based roadmaps more than two decades ago (Kappel 1998; Willyard & McClees 1987). These paper-based roadmaps were later produced electronically, and can now be accessed and updated on-line. An introduction to Motorola's technology roadmapping approach can be found in (Richey & Grinnell 2004). Motorola now uses the Alignent technology roadmapping package ([www.alignent.com](http://www.alignent.com)). The Alignent software is also available at Purdue University, enabling organisations to take part in web-based technology roadmapping exercises (Duckles & Coyle 2002).

The Cambridge University Centre for Technology Management (CTM) has developed the T-Plan 'fast start' workshop-based technology roadmapping methodology (Phaal, Farrukh & Probert 2004b), which has been applied in a wide range of companies. Table I presents a selection of technology roadmapping methodologies and their scopes.

**Insert Table 1 here**

Companies apply technology roadmapping primarily to ascertain what an evolutionary future is likely to offer, and to indicate actions that could be taken to be successful in such a future. It is carried out when organisations (departments, companies, sectors, countries or even economic regions) come to a decision point, for example prior to an annual allocation of funds or when a crisis due to a rapid loss of market share.

Figure 1 illustrates a simple company-level technology roadmap in the form of a multi-layered chart, with time running along the x-axis, and the relationships between events or key stages in each layer indicated by arrows.

**Insert Figure 1 here**

Since its initial development in the 1970's, technology roadmapping has passed through several stages. Bucher suggests that technology roadmapping has developed through two generations, and that a third generation is now emerging (Bucher 2003):



- **First generation** (1970s to mid-1980s): Methodologies aimed at clear and accurate technology forecasting.
- **Second generation** (mid-1980s to end-1990s): Methodologies aimed at improving strategic technology planning decisions.
- **Third generation** (end-1990s – today): Methodologies aimed at producing integrated technology management activities.

Third generation technology roadmapping is still largely at a developmental stage, and there is little supporting software to enable the integration of it into enterprise business processes.

### **3 The University of Nottingham STAR<sup>®</sup> technology roadmapping methodology**

The University of Nottingham's Strategic Technology Alignment (STA) Subgroup was formed in 2001 to enable a major effort in the area of technology planning, of which technology roadmapping is regarded as a key activity.

As technology roadmapping becomes more widely applied, its purpose, scope and effectiveness are bound to change. However, it is beneficial to have a working definition, and the University of Nottingham STA Subgroup's current 'working definition' of enterprise-level technology roadmapping is:

*"A methodology aimed at optimising technology development and acquisition in order to enhance the achievement of enterprise strategic goals and minimise the risk of technology-based disruption."*

The STA Subgroup developed a first generation technology roadmapping methodology and applied it at a high technology industrial collaborator (Gindy et al, 2006). Steps of this methodology were also utilised for the purpose of requirements capture at several other companies and at industrial forums. The methodology enabled the assessment of R&D project proposals on the basis of four factors – investment and benefit (the conventional financial methods), opportunities and risks. Opportunities covered a wide range of factors including technology alignment to product and capability requirements, opportunities for partnerships and knowledge benefits.

Following feedback from several applications of the methodology, it was considered that it was difficult to determine the degree of (or adequacy of) the proposal's technology alignment to company product and capability requirements. It was therefore decided to develop an enhanced methodology by adding a specific *technology alignment* factor that deals only with the alignment of the project proposal technologies to product and capability requirements now and in the future; this issue is detailed in [Gindy et al 2006], Section 5: Further work.

The enhanced methodology, referred to as the Strategic Technology Alignment Roadmapping (STAR<sup>®</sup>) system, has three major factors, used to evaluate R&D project proposals, each with two or three sub-factors, as listed below:

1. Economics (E):
  - Financial investment
  - Financial benefit

## 2. Technology alignment (T):

- Product requirements capture
- Competitiveness - benchmarked capabilities
- Familiarity – technology watch

## 3. Synergy (S):

- Opportunities
- Risks

The addition of a specific technology alignment factor at the top level enables us to evaluate projects and to balance a portfolio taking account of the company's technology requirements. The relative importance of each of the top level factors (financial, technology alignment and synergy) can be decided directly by assigning weights to each.

STAR<sup>®</sup> is described in detail in the following subsections.

### **3.1 Introduction to STAR<sup>®</sup>**

STAR<sup>®</sup> is a directed, "needs-driven", technology planning process aimed at aligning enterprise R&D activities to its business environment through identifying, selecting, prioritising and developing technologies to satisfy market and product needs, enterprise drivers and technology competitiveness position.

The process acts as an integrative framework for bringing together expert knowledge to collect, generate, organise and analyse technology planning information. The tools used to assist team members in their decision making, in

particular, the analytic hierarchy process (AHP), provide transparency in the process and build consensus and confidence in the technology priorities that are output from the process. Figure 2, shows the STAR<sup>®</sup> framework with its three phases and illustrates the flow of activity from beginning to end.

**Insert Figure 2 here**

### **3.2 STAR<sup>®</sup> processes**

The STAR<sup>®</sup> methodology is based on closely coupling several techniques and methodologies to provide an integrated framework for guiding and justifying investments in R&D projects to achieve the optimum project portfolio that supports enterprise business drivers. It is intended to be a third generation system, i.e. one that is aimed at supporting several technology management activities.

The amount of data and information generated during the roadmapping process is large, very diverse and potentially very valuable for many applications. This information must be collected and stored systematically to facilitate processing and decision-making, not just for a single roadmapping session, but for re-evaluation and re-use within and externally to the roadmapping process.

Most of the data required for STAR<sup>®</sup> is captured via in-house developed software tools and stored in a common knowledgebase, which covers business drivers, market drivers, market segments, products, technologies, etc., and their relationships and hierarchies. This integrative, interactive knowledgebase has been designed in generic form and can, without modification, handle any

requirements hierarchy, technology hierarchy, drivers (e.g. strategic and local business drivers, market drivers, and 'voice of customer' drivers). It can also supply information for benchmarking, and partially populate the ontologies used by the technology watch functions (see later). It also captures the intermediate decisions and outputs of individual technology roadmapping activities, which can therefore be re-evaluated at a later stage.

### **3.3 STAR<sup>®</sup> phases and components**

Implementation of the STAR<sup>®</sup> process can be broken down into three major phases as shown in Figure 3. These are described in the following subsections.

**Insert Figure 3 here**

#### **3.3.1 Phase 1: Preliminary scoping and development of hierarchies**

The main aim of this phase is to define the overall scope of the STAR<sup>®</sup> process for the user's enterprise, to adapt the generic framework provided by STAR<sup>®</sup>, collect and store the information that is required to support decision-making for technology acquisition projects, and to define the factors (and their weightings) used to assess technology project proposals.

The preliminary phase starts with the formation of a STAR<sup>®</sup> team, consisting of personnel with appropriate levels of knowledge regarding the enterprise organisational structure, markets, current and future products, product life cycles, market and business drivers, supply chain, make and buy strategies, and the manufacturing technologies used in product manufacture. In order to be effective

(in terms of knowledge and stakeholder commitment), the team will typically consist of personnel from a range of departments and at various levels in the organisational hierarchy.

The team activities in this phase include:

1. Development of a map of potential enterprise goals and business drivers, their definitions and linkages (e.g. cost reduction, quality improvement, delivery performance, agility and responsiveness).
2. Adaptation of the generic structures and overall framework of STAR<sup>®</sup> (markets, products, technologies and R&D projects etc.).
3. Mapping of the structure of the enterprise, its major functions and activities.
4. Mapping of the detailed descriptions and classifications (taxonomy) of the technologies of relevance to enterprise operations and any potential new and potentially disruptive or displacing technologies that may be useful to include in the data collection phase. Figure 4 illustrates the upper layers of such a taxonomy.

**Insert Figure 4 here**

5. Development of the requirements capture hierarchy, to link enterprise business drivers to enterprise technologies. The requirements capture hierarchy should allow top-down decomposition of enterprise business drivers and the identification of the impact of the various technologies on product groups, and part families.

There may be several requirements capture hierarchies, each associated with a major product group. The requirements capture hierarchy is required in order to associate technologies (product, material, process) with products and business drivers (see Figure 5). The hierarchical structure of a simple product may be very shallow; for example in the case of an electric kettle, it may be sufficient to consider only the product and first level assemblies and components. However, the hierarchical structure of a complex, technically-advanced product such as an aircraft may be very deep, and it may be necessary to consider product, assembly, sub-assembly, component, part family and features.

**Insert Figure 5 here**

6. Implementation of the STAR<sup>®</sup> enterprise technology benchmarking framework.
7. Implementation of the STAR<sup>®</sup> enterprise technology watch framework.
8. Selection of the key additional factors that make up the synergy factors (in terms of opportunities and risks) for the enterprise. STAR<sup>®</sup> includes a generic set of synergy elements that can be adapted to individual enterprise requirements. These are used directly in the assessment of project proposals (see Subsection 3.3.3).

Although these activities are potentially very time-consuming, much of the information is normally available within the enterprise. Also, the degree of detail that is required will depend on the ultimate users of the roadmap. The STAR<sup>®</sup>

methodology can be initially used even with a limited set of information, and more detail can be added as the data becomes available

At the completion of the preliminary phase, the enterprise will have populated the STAR<sup>®</sup> framework with the business, organisational, product and technology information that define the key areas of importance and interest to that enterprise. It will also have identified and defined the various factors (financial, internal & external constraints, desirable and undesirable intangibles) that should be considered when evaluating R&D project proposals, for example collaboration, partnerships, subcontracting, funding, expertise, resources, intellectual property rights and confidentiality.

The information that is required is split into three major factors (as stated earlier) – economics, technology and synergy. These enable proposed projects to be evaluated to express the alignment to these drivers:

- Economic factors: Including financial investment and benefits.
- Technology factors: Including technology requirements, technology benchmarking and technology forecast factors
- Synergy factors: Including opportunity and risk factors other than direct financial factors.

### **3.3.2 Phase 2: Technology requirements**

The main purpose of this phase is to evaluate and rank the technologies that are key to current and future enterprise success. This technology information



provides the basis for creating R&D projects that are linked to business needs, and contributes to the assessment of R&D projects.

It is very important to achieve consensus in this phase, as the outputs of the phase define the technology priorities of the enterprise. A team-based approach is utilised (in particular in *requirements capture*, see Phase 2, Step 1), in which a facilitator encourages team members to discuss and come to a decision on the relative priority of each factor under consideration (e.g. technology).

This phase includes three steps:

- Requirements capture: Aimed at information gathering to define the enterprise's key business drivers and the associated product and technology priorities.
- Benchmarking: Aimed at assessing the enterprise competitive position in a range of technologies of high relevance to enterprise activities.
- Technology watch: Aimed at assessing the state-of-the-art and forecasting technology progress in emerging technology areas of potential relevance to ongoing and planned future enterprise activities. Based on this assessment, technology areas requiring further investigation can be highlighted.

The detailed activities of this phase are described below.

### **Phase 2 Step 1: Requirements capture**

The STAR<sup>®</sup> requirements capture hierarchy (see example in Figure 4) is used to rank and score products (to provide *product priorities*) and technologies (to

provide *technology priorities*). This ranking activity is carried out via facilitated workshops, utilising an AHP tool.

The workshops originally utilised a proprietary analytic hierarchy process (AHP) package to rank the relative importance of business drivers, products and technologies; however, this was found to be unsatisfactory as, on occasions, workshop delegates later questioned the outcomes of the workshops. Therefore, an AHP-based software tool was developed to enable multiple layers in a requirements capture hierarchy to be ranked in a single session, to capture the key reasoning of the workshop team, to generate a report (confirming the activities and results) and to capture the results in the STAR<sup>®</sup> database. This enabled immediate printing and emailing of the whole session to delegates, and also enabled later workshops to re-open and continue the session, if required. The requirements capture step provides inputs to the project assessment phase in the form of the *product priority* and *technology priority* factors.

### **Phase 2 Step 2: Benchmarking**

The benchmarking step of the STAR<sup>®</sup> process enables the enterprise to make an accurate assessment of its competitive position with regard to technology maturity (base, key, pacing and emerging). The aim is to ensure that the enterprise is ahead of the competition in technologies that provide its products and/or services with a competitive advantage, and that it is satisfactorily placed to exploit other technologies. For example, it may be unsatisfactory to be only two years ahead of the competitors in certain casting technologies but, at the same time, satisfactory to be one year lagging in certain machining technologies.

The STAR<sup>®</sup> benchmarking step utilises an in-house-developed software tool that enables the user to enter the technology competitive position graphically (see Figure 6). The results are stored in the STAR<sup>®</sup> database. The benchmarking step provides an input to the project assessment phase in the form of a *level of concern* factor.

**Insert Figure 6 here**

### **Phase 2 Step 3: Technology watch**

Technology watch can highlight technologies (or combinations thereof) at an early stage of development that may offer potential opportunities or pose threats to the enterprise. A manually-applicable technology watch methodology has been developed for use within STAR<sup>®</sup>. This consists of:

1. **The identification of key technologies ‘ripe’ for replacement:** These technologies should have been placed within the enterprise’s manufacturing taxonomy during the preliminary phase, and most should have been identified via the requirements capture and benchmarking exercises.
2. **The identification of these technologies’ underlying functionalities, and their expression within a revised functional ontology set:** This revised super-taxonomy provides a framework that enables potentially disruptive or displacing technologies to be searched for, identified and evaluated at an early stage. It contains the enterprise’s technologies in the relevant areas, and also other known, related technologies.

3. **The identification of potentially competing emerging technologies:** This is assisted by the above functional ontology sets, but is currently the least formalised part of the technology watch process.
4. **The application of the STAR<sup>®</sup> technology data collection process to each emerging technology:** This process is a step-by-step approach that includes the gathering of information on R&D, patents, applications, suppliers, competitor interest, displaced and alternative technologies, etc., from a range of internal and external sources. The output from this process is a standard structured 'emerging technology' report on each technology and a summary report that covers all of the selected emerging technologies.
5. **The assessment of emerging technologies by a group of experts:**  
Following receipt of the emerging technology reports, the STAR<sup>®</sup> AHP software tool (described earlier) can be used to assess the importance of each emerging technology. Alternatively, another approach, e.g. Delphi, or questionnaires (sent to internal experts and, potentially, technology suppliers and academics) can be used. In addition to the potential threats from, or benefits of, the technologies, it is also necessary to assess the likelihood of the technology reaching maturity, and the likelihood of the enterprise failing to track its process. To this end, a technological threats and opportunity analysis (TTOA) scoring system has been developed, akin to the well-established failure mode and effects analysis (FMEA) method.

The technology watch step provides an input to the project assessment phase in the form of a *technology threat/opportunity* factor for each technology.

### 3.3.3 Project creation and assessment phase

This is aimed at the generation of R&D projects proposals, and the selection of a balanced set of projects from these that together represent an optimised R&D portfolio aligned to enterprise requirements. This includes:

- Project generation: Aimed at the generation of candidate R&D project proposals that address enterprise requirements described in (2) above.
- Project assessment: Aimed at assessing the impact of R&D projects on enterprise objectives.
- Portfolio balancing: Aimed at optimising the selection a group of R&D projects to maximize the impact of the projects on company operations within budget constraints.

#### **Phase 3 Step 1: Adjustment of assessment settings**

- Aligning the project assessment settings (prior to the creation of proposals): Based on the outputs from the requirements capture, benchmarking and technology watch activities (Phase 2, above), the technology manager fine-tunes the project assessment settings to reflect needs, e.g.:
  - to score projects addressing current products above those addressing future products,
  - to score projects addressing key technologies above those addressing base technologies,
  - to score projects addressing high technology readiness levels (TRLs) above those addressing low target TRLs.

- Adjusting the project assessment settings: to ensure that projects that are aligned to the enterprise's technology requirements score more highly than those that are not. A statement indicating these general preferences is released to project proposal authors.

### **Phase 3 Step 2: Project generation**

Information from phases 1, 2 and phase 3 step 1 are made available to the individuals or teams that are responsible for the development of project proposals. In addition, company policies with regard to the current R&D round will be made clear, for example that there should be a certain percentage (by total cost) of projects aimed at technology insertion in ten to fifteen years time.

Although there is a risk that project proposals will reflect the individual biases of their developers, they will be aware that the proposals must pass predefined thresholds; this will encourage a strong measure of objectivity.

All project proposals must include in their descriptions sufficient information to allow the calculation of seven assessment factors used to evaluate each project:

- Project financial figures, *financial investment* factor (I) and expected project *financial benefit* factor (B);
- Project contributions to technology development (T), these include:
  - Contribution towards the enterprise's product requirements placed on this technology.

- Contribution towards the enterprise's required competitive position in the stated technology (e.g. 2 years ahead of the competition) based on the benchmarking requirements.
- Contribution based on the technology developments that may be profitable for the enterprise to exploit, or dangerous to ignore.
- Project synergy:
  - Factors which enhance the chances of project success and/or produce further benefits to the enterprise (e.g. working with suppliers who will be responsible for implementing the technology, partnerships with leading edge research organisations); this enables the calculation of an *opportunity* factor (*O*).
  - Factors which are considered as risks that may reduce the project's likelihood of delivering its expected non-financial outcomes or reduce the benefits that the company may get from the project, (e.g. collaboration with competitors, use of scarce resources); this enables a value to put on a *risk factor* (*R*).

Phase 3 steps 1 and 2 should result in the desired technology alignment of the submitted proposals.

### **Phase 3 Step 3: Project assessment**

All project proposals can be assessed en masse, each with appropriate weighting given to its three main assessment factors (Economics =E, Technology=T and Synergy=S). Weightings can be used, for example, to favour certain types of projects (e.g. near term projects if it is desirable).

The assessors (who will typically include some of the proposal developers or champions) utilise the information from phases 1 and 2 to assess the project proposals. Projects that fail to address any of the key technology issues are unlikely to be given approval.

**Economic (E) assessment:**

The economic assessment is based on the financial investment required by the project, and the financial return expected. Typically, this will be calculated using the enterprise's standard approach (e.g. net present value, discounted cash flow).

**Technology (T) assessment:**

**Product priority (P):** The project's contribution towards the enterprise's direct product requirements for the chosen technology is assessed from the project description. Combined with the *product priority* and *technology priority* factors, this enables the calculation of a *technology priority* factor (P).

**Benchmarking - competitiveness (C):** The project's contribution towards the enterprise's required competitive position in the stated technology (e.g. 2 years ahead of the competition) is assessed, based on the benchmarking requirements (K2). This, combined with the *technology priority* and benchmarking *level of concern* factors, enables the calculation of a *technology competitiveness* factor (C)

**Technology watch - familiarity (F):** The project's estimated contribution based on the technology developments that may be profitable for the enterprise to exploit (K3). This, combined with the *technology priority* and *threat/opportunity* factors enables the calculation of a *technology familiarity* factor (F).



**Synergy (S) assessment:**

The synergy assessment is based on an adapted list of opportunities and risks provided with the STAR<sup>®</sup> knowledgebase, and produces values for project opportunities and risks.

A spreadsheet software tool is currently used to calculate project scores and to rank them (see Figure 7). It also provides information that may lead to rejection of individual proposals on the basis of thresholds that are associated with any of the assessment factors, for example lack of technology alignment, excessive risk, etc.

**Phase 3 Step 3: Portfolio balancing**

Project proposals should not be selected solely on the basis of their scores and ranks. It is important that an appropriately balanced portfolio is achieved in order to ensure that:

- an effective mix of technologies is developed for insertion into the enterprise,
- an appropriate balance is achieved between short-term and long-term projects, and
- utilisation of human, plant and other resources is within enterprise capacity.

Ultimately, the task of ensuring an effective portfolio will require the experience and judgement of a manager. Several graphical tools are provided in STAR<sup>®</sup> to assist in this activity, as follows:

1. Technology frontier curves or graphs
2. Cost/timeline scatter diagram
3. Radar diagrams

These are explained briefly below, and examples are provided later.

### **1-Technology frontier curves or graphs**

The technology frontier is used in the second phase of STAR<sup>®</sup> as a project visualisation technique; project proposals that appear on the frontier are not 'dominated' by other proposals in terms of their sets of attributes (in our case - economics, technology and synergy, or attractiveness and investment). The frontier analysis is useful in offering managers and decision-makers more flexibility to trade off any attractiveness dimension with any other dimension. For example, managers can choose to trade-off technology and synergy against pure monetary outcome.

As can be seen in Figure 8, a set of projects is displayed, showing those that are most efficient on the technology frontier curve (projects P16, P15 and P12). A trade-off between those efficient projects can then be made to favour one over the others. However, the process can also be enhanced by adding threshold limits for investment as a budget limits and/or attractiveness limits accepted by the group of decision makers, as in (Kirby & Mavris 2002) and as in Figure 8. Managers can then make a list of efficient projects resulting from the analysis and decide how much investment budget is required for implementation.

A detailed presentation on the application of the technology frontier to portfolio assessment (as part of a technology roadmapping exercise) can be found in (Cerit, Morcos & Gindy 2005). An explanation of the more general *efficient frontier* can be found in (Markowitz 1991) and (Morcos & Singh 1992). The

technology frontier has also been used for investments decisions in technology management by (Kirby & Mavris 2000, 2001 & 2002).

## **2-Project cost/timeline scatter diagram**

The project cost/timeline scatter diagram is a chart that presents the distribution of projects in terms of their costs against target implementation dates (e.g. incorporation of the project technology into a product or process). It is produced by plotting (from Figure 7) project cost against technology target implementation date for each project, and provides a very useful view of the balance between near-term and long-term investment in technology. Figure 9 illustrates a project cost/timeline scatter diagram. This chart shows 55 projects, including the 15 projects (P11 to P25) shown in Figure 7.

## **3-Radar diagrams**

Radar diagramming is a mapping technique in which axes representing key factors radiate out from a central point; the actual values for each project are then joined together, giving the appearance of a spider's web. Figure 10 shows a generic radar diagram with a scale from zero to ten on each axis. This allows the mapping of a set of project proposals on each individual axis or element to produce a set of nested or overlapping polygons.

### A sample application

In this example, a set of 15 projects has been elicited in Phase 3, Step 1. These projects were actually generated within the research group, but were based in some cases on actual industrial projects, and in other cases on discussions with our industrial partners.

Figure 7 illustrates an early STAR<sup>®</sup> project proposal assessment spreadsheet containing the 15 project proposals (P11 to P25). Note that P01 to P05 are test proposals that are used to validate the spreadsheet calculations for extreme values. The current version of the project proposal assessment spreadsheet also contains a column that provides an estimate of the number of years before the technology can be injected into the company's products or processes.

In this application, the spreadsheet calculates the economic factor (E) as B-I, the technology factor (T) and the synergy factor (S) as O-R. The proposal scores are also illustrated in Figure 7.

The weightings in the spreadsheet (see 2<sup>nd</sup> row) are set to financials (E) = 50%, technology (T) = 35% and synergy (S) = 15%, but these can be changed in seconds according to managers' preferences to generate new scores and rankings.

The third-from-right column presents the proposal percentage scores, and the two right-hand columns present the proposal rankings with all factors taken into account, and with just financial factors taken into account. As can be seen, even

with the economic (financial) factors weighted as high as 50%, a third of the projects have changed in the ranking order.

**Insert Figure 7 here**

**Insert Figure 8 here**

**Insert Figure 9 here**

**Insert Figure 10 here**

#### **4. Industrial applications**

STAR<sup>®</sup> is being developed into an integrated system that captures, retains and shares information for re-use within STAR<sup>®</sup> and by other functions. However, its full implementation represents a significant undertaking for an enterprise, and therefore its software-supported elements are also intended to be capable of application as independent tools. It is in this mode that STAR<sup>®</sup> has been applied in industry to-date.

The requirements capture tool of STAR<sup>®</sup> has been used and evaluated by our key collaborator, and has been adapted to meet its needs relating to the capture of informal discussion. The STAR<sup>®</sup> technology watch methodology is being applied by the same collaborator in order to produce partially populated ontologies for two areas of technology; one of these areas currently imposes significant manufacturing constraints, the other area includes interesting emerging technologies.

At the industrial sector level, the requirements capture and technology watch methodologies have been adapted and utilised to analyse process technologies of interest to the UK aerospace sector, and to produce recommendations for research investment in the medium-to-long term (Gindy, Hodgson and Johnston 2006).

The technology watch methodology has also been used at roadmapping workshops held for UK small/medium manufacturing enterprises (SMEs) to identify technology threats and opportunities arising from foreign competition and new materials and process technologies.

## **5. Future work**

The STAR<sup>®</sup> methodology is now sufficiently developed that it requires detailed evaluation of the integrated methodology, rather than evaluation of independently-applied elements, as has taken place to-date. To this end, members of the STAR<sup>®</sup> team are now discussing potential ways forward with the key industrial collaborator.

Initial work with the collaborator will include tests of the STAR<sup>®</sup> methodology using project proposal data from current or previous R&D funding rounds. The key outcome from this industrial evaluation is not intended to be the development of a company-specific version of the STAR<sup>®</sup> methodology, but the enhancement of a range of adjustable parameters provided within the STAR<sup>®</sup> methodology to enable it to represent a range of enterprise needs.

Further work includes the insertion of a full capacity-constrained, time-phased technology requirements planning capability into STAR<sup>®</sup>. This will take account of prior commitments, and will result in improved realism in technology planning.

## 6. Conclusions

There is a clearly identified need for technology roadmapping, at the national, industrial sector and individual enterprise levels, in order to ensure the implementation of effective technology acquisition programmes.

STAR<sup>®</sup> is primarily intended for application at the enterprise level, where its software-based tools and shared database enable decisions to be revisited or re-evaluated with minimum effort. STAR<sup>®</sup> represents an advance in the state of the art of enterprise technology roadmapping in that it offers technology managers the facility to tune the project assessment stage to reflect current priorities, i.e. to encourage the alignment of technologies to company requirements.

To-date, the flexibility to allow users at the enterprise and industrial sector level to select and apply individual elements of the STAR<sup>®</sup> methodology in order to obtain quick answers to specific questions, has proved to be a significant asset. It is therefore important to ensure that technology roadmapping systems such as STAR<sup>®</sup> can still offer 'quick and dirty' partial solutions to the problems of technology forecasting, selection and acquisition.

The STAR<sup>®</sup> methodology is now at a stage of development that it requires a detailed industrial evaluation of the full system. Discussions are in-progress with a view to such an evaluation.

## 6. References

Bucher, P. E., *Integrated Technology Roadmapping: Design and Implementation for Technology-Based multinational Enterprises*, (ETH Zurich), 2003.

Cerit, B., Gindy, N., Hodgson, A., and Halliday, S., Roadmapping technology through TIS - Technology Investment Strategy, *Advances in manufacturing technology*, *Proceedings of second international conferences on manufacturing research, ICMR 2004*, edited by Saad, S and Perera, T, Sheffield Hallam University, Sheffield, UK, 2004, pp. 380-385.

Cerit, B., Morcos, M., and Gindy, N, Portfolio visualisation and selection of R&D projects as an aid to improve the decision-making process, *Proceedings of the 3<sup>rd</sup> International conference on responsive manufacturing, ICRM 2005*, edited by Gindy N.Z. and Chen, X, 2005, pp-448.

Conger, T. and Chiavetta, D., The pulse of industry, *Industrial Engineer*, 2006, vol. 38, no.1.

Duckles, J.M. and Coyle, E.J. *Purdue's Center for Technology Roadmapping: A Resource for Research and Education in Technology Roadmapping*. Purdue Centre for Technology Roadmapping paper, 2002, Download from:



<http://roadmap.itap.purdue.edu/ctr/documents/CenterforTechnologyRoadmapping.pdf>

EIRMA, Technology Roadmapping - Delivering Business Vision, *European Industrial Research Management Association*, Paris, 1997, 52.

Emerging Industries & Technologies Forum, Technology Planning for Business Competitiveness, *Emerging Industries*. 2001.

ETN-SEE, Vision 2020 – the EMC technology roadmap, European Technology Network – Sustainable Electromagnetic Environments, 2006, 16 pages. Can be downloaded (in 2007) from web page:

[http://www.etsi.org/standards&interop\\_in\\_ICT\\_ETPs/Conference%20pack%20V2/Background/Brochure%20ETN-SEE%2021%20April%202006.pdf](http://www.etsi.org/standards&interop_in_ICT_ETPs/Conference%20pack%20V2/Background/Brochure%20ETN-SEE%2021%20April%202006.pdf)

Farrukh, C. J. P., Phaal, R., and Probert, D. R., Industrial practice in technology planning - Implications for a useful tool catalogue for technology management, *Institute of Electrical and Electronics Engineers Inc.*, Portland, OR United States, 2001, p. 200.

Gindy, N., Cerit, B., and Harvey, R., Technology Investment Strategy: The Vision of Technology, *13th International Conference on Management of Technology*, 2005, Washington D.C., USA.

Gindy, N. Z., Cerit, B., and Hodgson, A., Technology roadmapping for the next generation manufacturing enterprise, *Journal of Manufacturing Technology Management*, 2006, vol. 17, no. 4.

Gindy, N. Z. and Saad, S. M., A Hierarchical model for responsive manufacturing, edited by. Gindy N. Z., Nottingham, UK, 1997, pp. 1-14.

Gindy, N.N.Z, Hodgson, A. and Johnston, S., Research Opportunities in Aerospace Manufacture – A NACAM White Paper. Report No. KTN/AeroDef Pub 0001/08/06, Issue 2, November 2006, 33 pages.

Grossman, D. S., Putting Technology on The Road, *Research Technology Management*, 2004, vol. 47, no. 2, p. 41.

Grupp, H. and Linstone, H. A., National technology foresight activities around the globe: Resurrection and new paradigms, *Technological Forecasting and Social Change*, 1999, vol. 60, no. 1, pp. 85-94.

Hodgson, A., Arman, H. and Gindy, N.N.Z., A technology watch function for the high technology enterprise, to be published in *International Journal of Industrial and Systems Engineering*, 2007, vol.2.

I\*PROMS, Deliverable D5.13 – Updated roadmap covering all PAC research areas, Project No. NMP2-CT-2004-500273, 2006, 61 pages.

Industry Canada, Technology Roadmapping: A Strategy for Success, *Industry Canada*, 2000, 0-662-29689-3.

Kappel, T. A. *Technology Roadmapping: An Evaluation*, 1998, (Evanston, IL: Northwestern University).

McMillan, A., Roadmapping - Agent of Change, *Research Technology Management*, 2003, vol. 46, no. 2, pp. 40-47.

Markowitz, Harry M., *Portfolio Selection*, second edition, Blackwell, 1991

Michelle R. K. and Dimitri N. M., A Method for Technology Selection on Benefit, Available Schedule Resources, *2000 World Aviation Conference*, October 10-12, 2000, San Diego, CA.

Michelle R. K. and Dimitri N. M., *A Technique for Selecting Emerging Technologies for a Fleet of Commercial Aircraft to Maximize R&D Investment*, 2001, (Published by SAE International with permission).

Michelle R. K. and Dimitri N. M., An Approach for the Intelligent Assessment of Future Technology Portfolios, *40th AIAA Aerospace Sciences Meeting & Exhibit*, 2002, Reno, NV

Miles, I., UK Foresight: three cycles on a highway, *International Journal of Foresight and Innovation Policy*, 2005, vol. 2, no. 1, pp. 1-34.

Morcos, M. S. and Singh, G., Portfolio analysis and its application to the various phases of civil engineering, in *Information technology for civil and structural engineers*", CIVIL-COMP, edited by Topping, B. H. V., and Khan, A. I., CIVIL-COMP press, 1992, Edinburgh.

Narayanan, S. and Jayaraman, S., A knowledge-based decision support system for apparel enterprise evaluation, in *Manufacturing Decision Support Systems*, edited by Parsaei, H. R., S. Kolli, & Hanley, T. R., 1997, pp. 67-110.

Phaal, R., Farrukh, C., and Probert, D., Structuring a systematic approach to technology management: concepts and practice, *IAMOT*, 2001, Lausanne.

Phaal, R., Farrukh, C., and Probert, D., Fast-Start Technology Roadmapping, *Centre for Technology Management*, 2002, University of Cambridge.

- Phaal, R., Farrukh, C., and Probert, D. (2004a), Customizing Roadmapping, *Research Technology Management*, 2004, vol. 47, no. 2, p. 26.
- Phaal, R., Farrukh, C.J.P. and Probert, D.R. (2004b). Collaborative technology roadmapping: network development and research prioritization, *International Journal of Technology Intelligence and Planning*, 2004, Vol. 1, No. 1, pp.39-55.
- Richey, J. M. and Grinnell, M., Evolution of Roadmapping at Motorola, *Research Technology Management*, 2004, vol. 47, no. 2.
- Ringland, G., *Scenario Planning - Managing for the Future*, 1998, (Wiley, Chichester, UK).
- SIA, International Technology Roadmap for Semiconductors, *Semiconductor Industry Association*, 1999.
- Twiss, B. C., *Forecasting for Technologists and Engineers: A practical guide for better decisions*, 1992, (Peter Peregrinus Ltd).
- Wagner, C. & Popper, S., Identifying critical technologies in the United States: a review of the federal effort, *Journal of Forecasting no. Special Issue 22*, 2003.
- Willyard, C. H. and McClees, C. W., Motorola's Technology Roadmap Process, *Research Management*, 1987, vol. 30, no. 5, p. 13.

# Strategic Technology Alignment Roadmapping STAR<sup>®</sup>

## Aligning R&D Investments with Business Needs

### IJCIM Paper - Figure captions

Figure 1: Simple company-level technology roadmap

Figure 2: STAR – three phases with their components

Figure 3: Upper levels of a manufacturing taxonomy

Figure 4: An example of a STAR<sup>®</sup> requirements capture hierarchy

Figure 5: An example of a STAR<sup>®</sup> benchmarking exercise

Figure 6: STAR<sup>®</sup> Overall Framework

Figure 7: Project proposal assessment spreadsheet

Figure 8: Technology frontier curve showing fifteen projects (P11 to P25)

Figure 9: Cost/technical maturity chart showing fifteen projects (P11 to P25)

Figure 10: Radar diagram showing fifteen projects (P11 to P25)

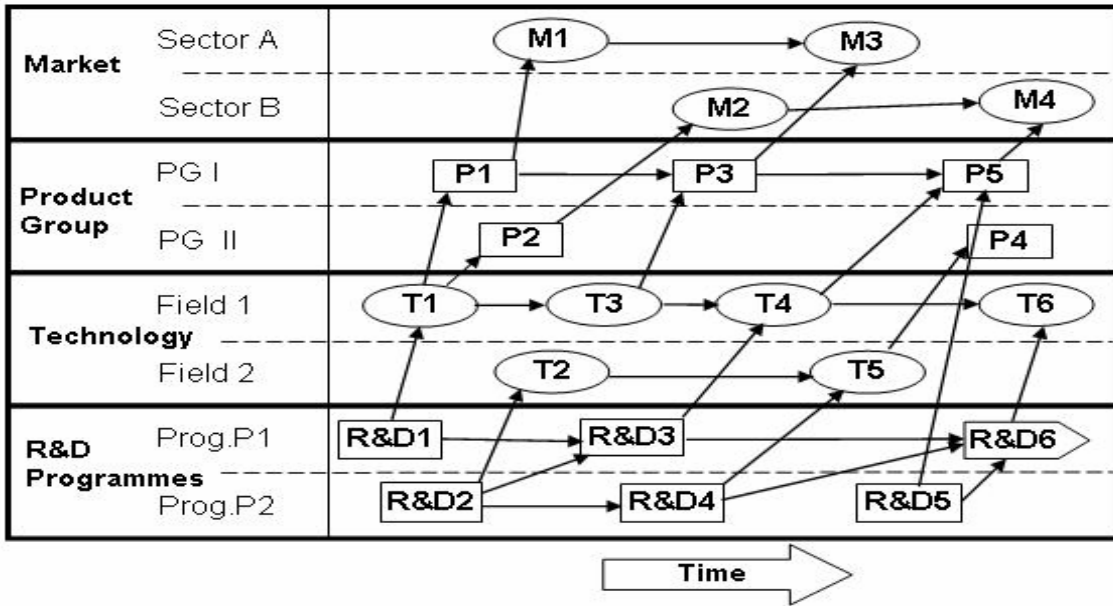

Figure 1: Simple company-level technology roadmap

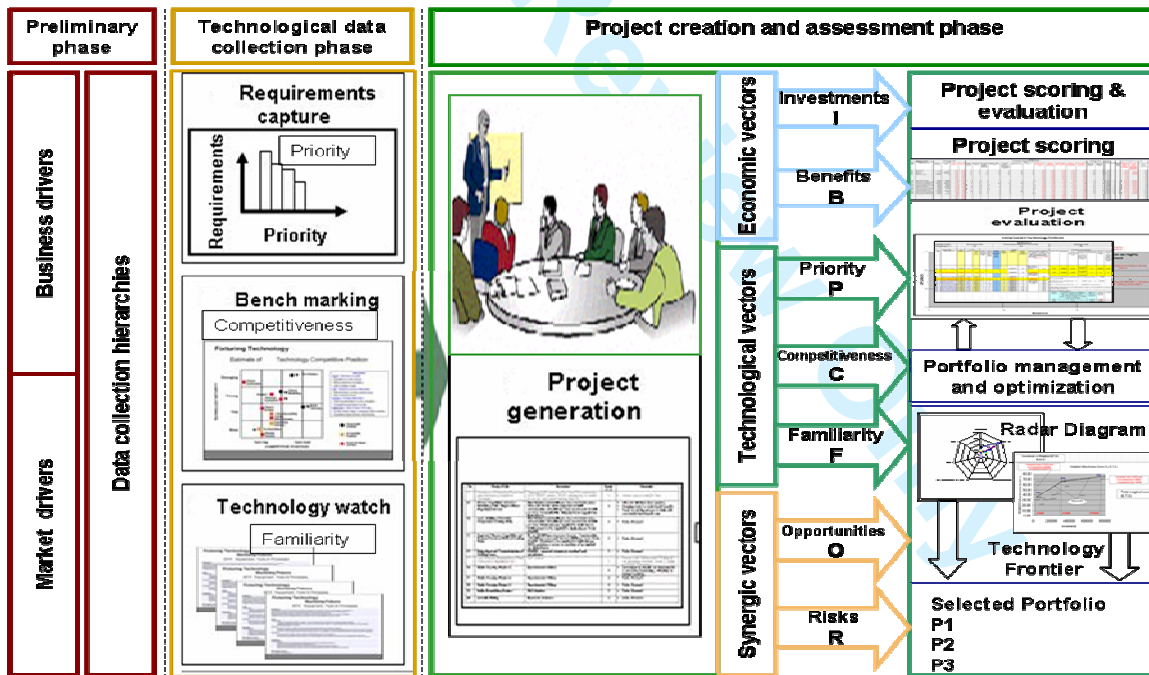

Figure 2: STAR® Overall Framework

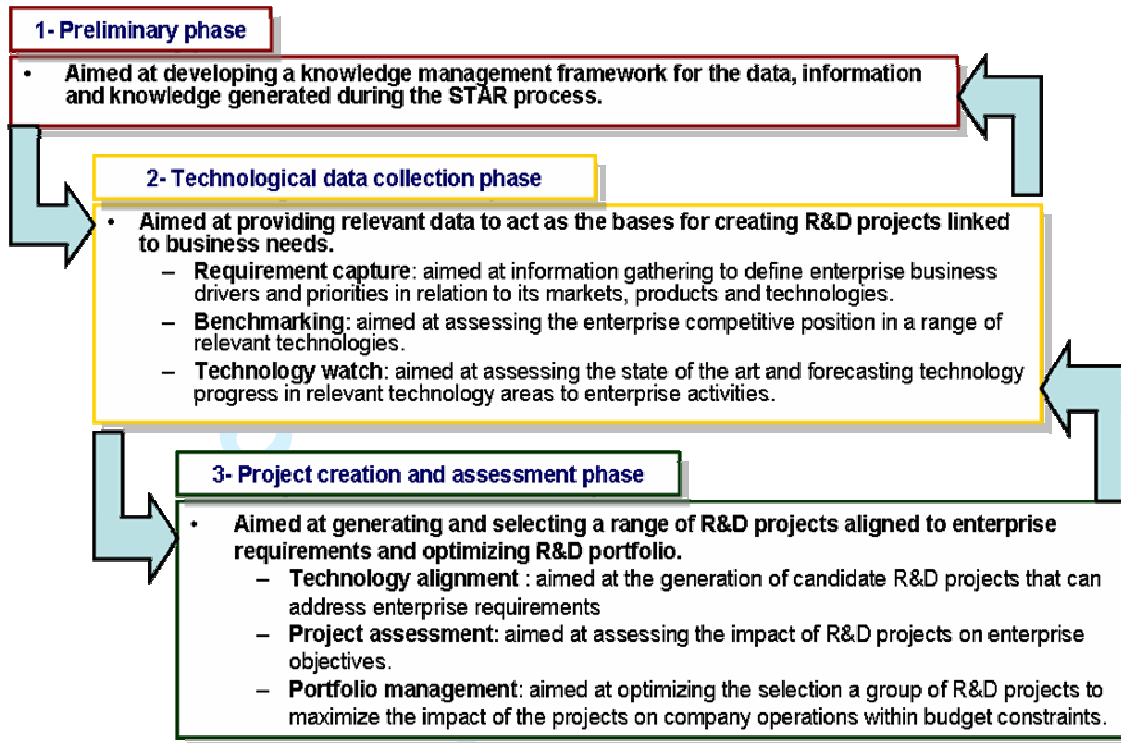

Figure 3: STAR – three phases with their components

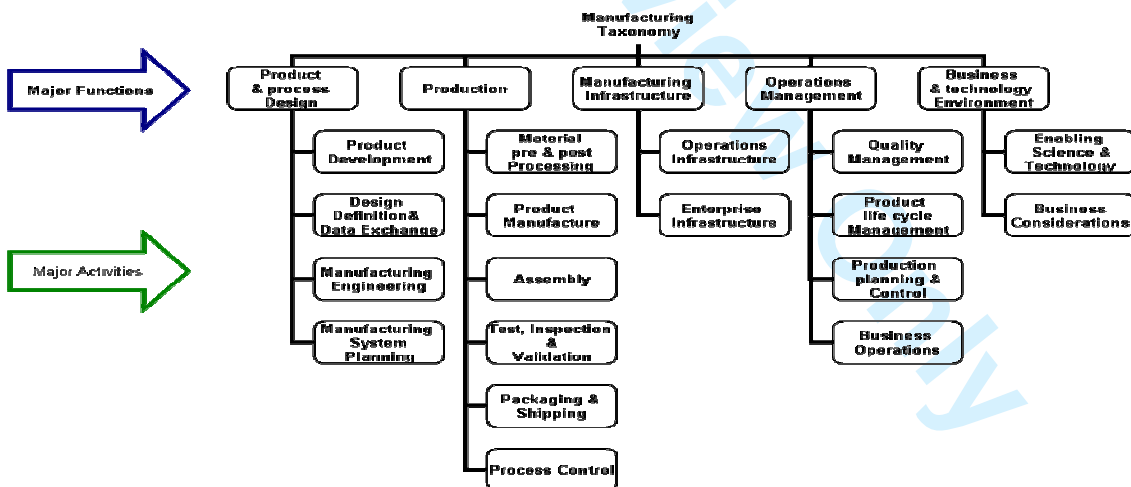

Figure 4: Upper levels of a manufacturing taxonomy



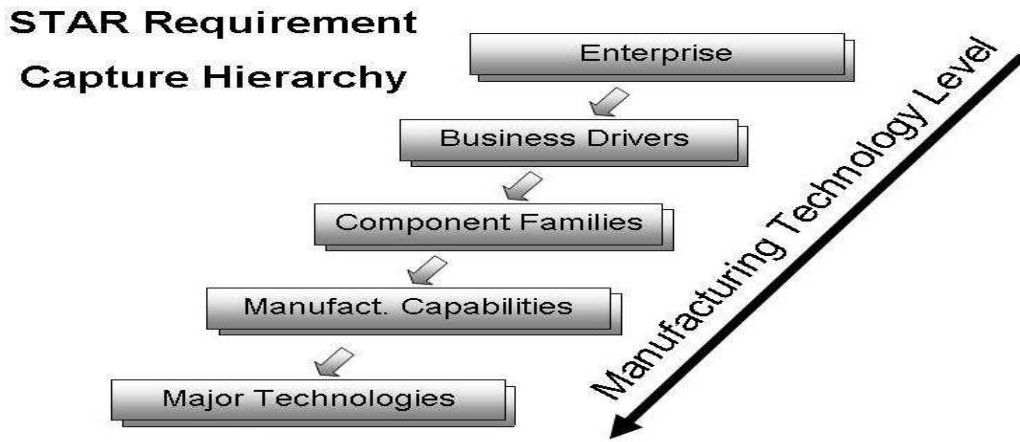

Figure 5: An example of a STAR<sup>®</sup> requirements capture hierarchy

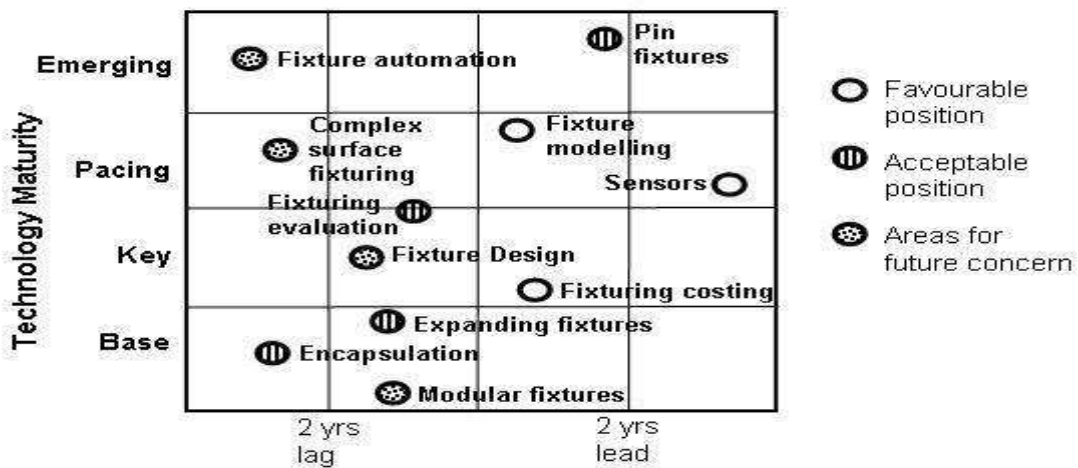

Figure 6: An example of a STAR<sup>®</sup> benchmarking exercise

SHORT STAR		Economics =2 B/I (max 10)			Technology Alignment=(P+C+F)3										Synergy=0-R							
Weighting % ->		50			35										15							
Pjt ID	Project description	Investment (£)	Benefit (£)	Factored investment to benefit ratio (out of 10)	Prior priority (out of 10)	Tech'y priority (out of 10)	K1 multiplier (product desirability) (out of 10)	Tech'y applicability (out of 10)	K2 multiplier (tech'y cat. base, hys, pacing or emerging) (out of 10)	Level of concern (out of 10)	Cap. /10	PP+TP vector (calculated & normalised to /10)	Tech'y priority vector (P) (out of 10)	Competitiveness vector (C) (out of 10)	Tech'y family vector (F) (out of 10)	Tech'y alignment (P+C+F) 3 (out of 10)	Opps /10	Risks /10	Synergy (0-R)3 (out of 10)	Total weighted score (%)	Rank (All)	Rank-financial (Investment) only
P01	All Zeros	0	0	0.00	0	0	0	0	0	0	0	0.00	0.00	0.00	0.00	0.00	0	0	0.00	0.00		
P02	All ones	100000	100000	2.00	1	1	1	1	1	1	1	1.00	1.00	1.00	1.00	1.00	1	1	0.00	13.50		
P03	Max scores	0	2000000	10.00	10	10	10	10	10	10	10	10.00	10.00	10.00	10.00	10.00	10	0	10.00	100.00		
P04	All fives	500000	500000	2.00	5	5	5	5	5	5	5	5.00	5.00	5.00	5.00	5.00	5	5	0.00	27.50		
P05	Tens & zeros	500000	0	0.00	10	0	10	0	10	0	10	7.07	0.00	0.00	8.91	2.97	10	0	10.00	25.59		
				0.00								0.00	0.00	0.00	0.00	0.00			0.00	0.00		
				0.00								0.00	0.00	0.00	0.00	0.00			0.00	0.00		
				0.00								0.00	0.00	0.00	0.00	0.00			0.00	0.00		
				0.00								0.00	0.00	0.00	0.00	0.00			0.00	0.00		
				0.00								0.00	0.00	0.00	0.00	0.00			0.00	0.00		
P11	Ceramic CC line	330000	910000	5.20	8	9	7	9	6	8	7	8.51	8.13	7.31	7.10	7.51	8	3	5.00	59.79	5	7
P12	Auto blank polis	750000	2000000	5.33	9	7	9	7	6	8	7	8.06	7.98	7.68	6.97	7.54	5	6	-1.00	51.67	8	6
P13	Fanblade integr.	200000	550000	5.50	8	6	7	5	6	7	7	7.07	6.28	6.75	6.67	6.57	5	3	2.00	53.49	7	5
P14	Friction stir weld	230000	600000	4.80	7	8	7	8	8	6	5	7.52	7.49	7.09	6.70	7.09	6	2	4.00	54.83	6	8
P15	Nichal alloy d	310000	1250000	8.06	7	8	7	10	6	8	7	7.62	8.07	7.09	6.81	7.32	7	1	6.00	74.96	3	3
P16	Laser marking c	25000	124000	9.92	7	7	7	9	8	8	6	7.00	7.61	7.48	6.95	7.35	5	1	4.00	81.32	1	1
P17	Rapid manufact	220000	550000	4.40	6	8	6	8	6	7	7	7.07	6.98	6.50	6.67	6.71	6	3	3.00	50.00	9	9
P18	Flexible fixturs	80000	120000	3.00	7	9	7	9	6	7	5	8.06	7.98	6.98	6.23	7.06	6	2	4.00	46.72	10	10
P19	Info system for	25000	121000	9.68	6	7	7	6	8	6	5	6.52	6.49	6.84	6.39	6.57	5	2	3.00	75.91	2	2
P20	Anti-corrosion	175000	650000	7.43	7	6	6	6	8	8	6	6.52	6.17	7.07	6.79	6.68	6	2	4.00	66.51	4	4
P21	Manufacturing y	75000	0	0.00	5	5	4	5	4	7	8	5.00	4.64	4.86	5.43	4.98	4	1	3.00	21.92	15	14
P22	Ceramic turbom	525000	250000	0.95	10	8	7	7	4	10	7	9.06	7.63	7.10	6.33	7.02	8	3	5.00	36.82	11	11
P23	Fibre-reinforced	110000	50000	0.91	5	8	4	7	6	10	7	6.67	5.72	6.33	6.54	6.20	8	3	5.00	33.73	13	13
P24	Laser micromat	175000	0	0.00	8	9	6	8	4	8	10	8.51	7.42	6.36	6.98	6.92	8	3	5.00	31.72	14	14
P25	Machining of E	210000	100000	0.95	7	8	6	6	4	7	10	7.52	6.47	5.96	6.70	6.38	7	2	5.00	34.68	12	12

Figure 7: Project proposal assessment spreadsheet

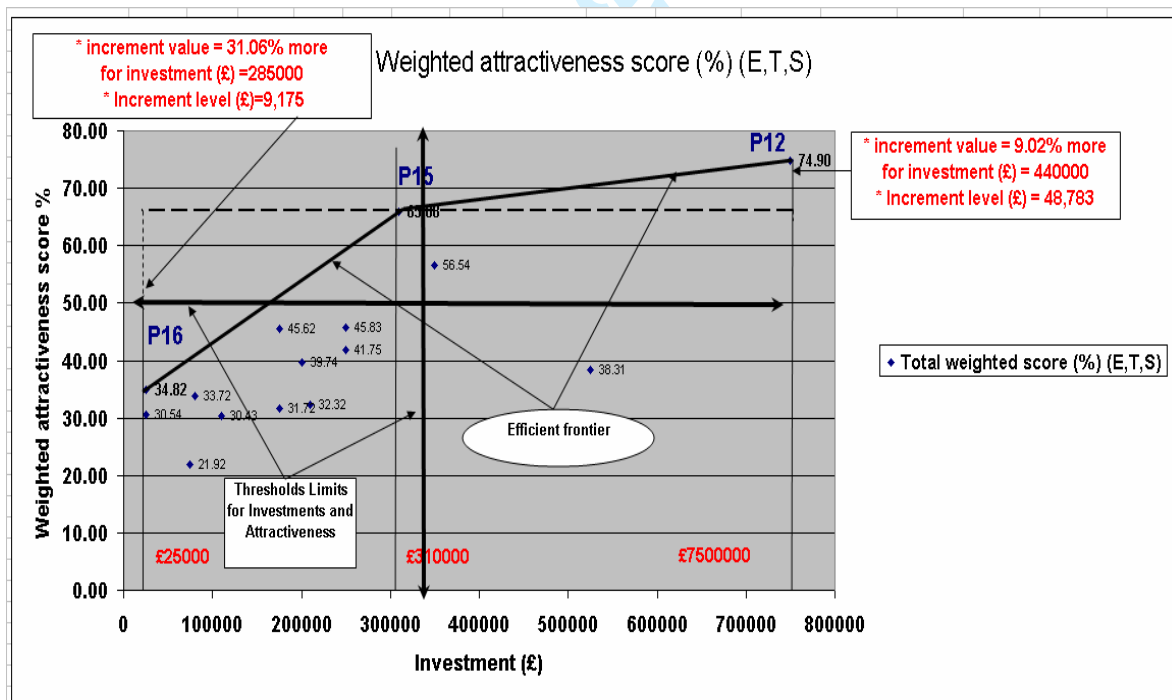

Figure 8: Technology frontier curve showing fifteen projects (P11 to P25)

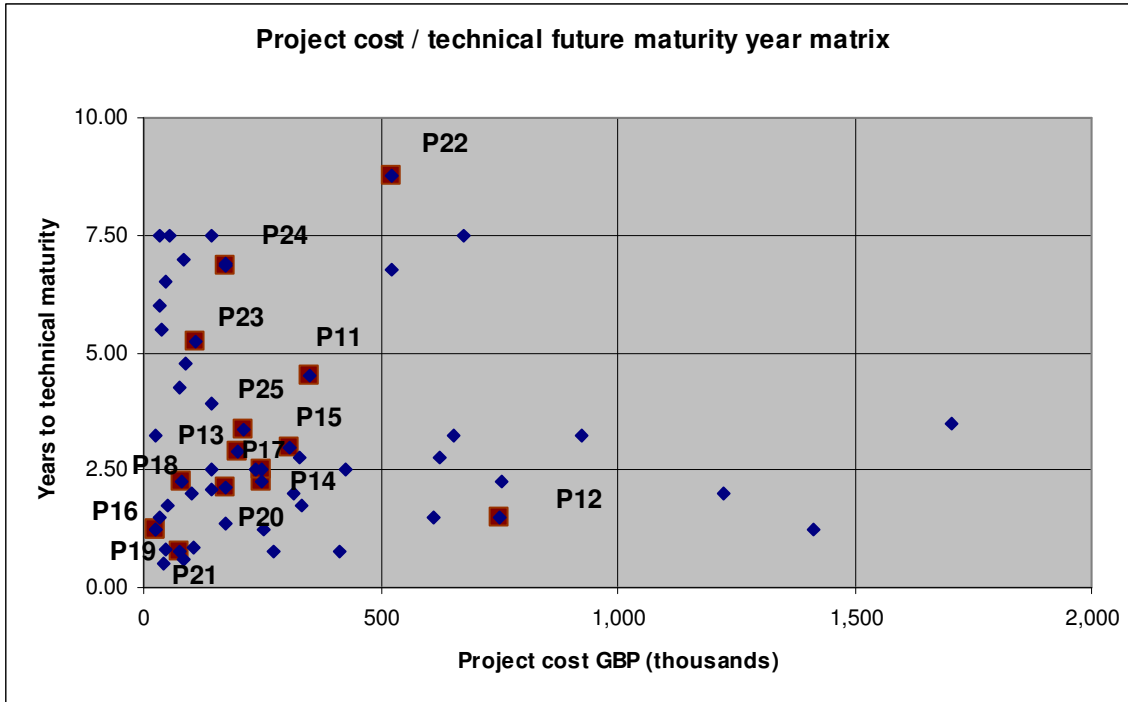

Figure 9: Project cost/timeline scatter diagram showing fifteen projects (P11 to P25)

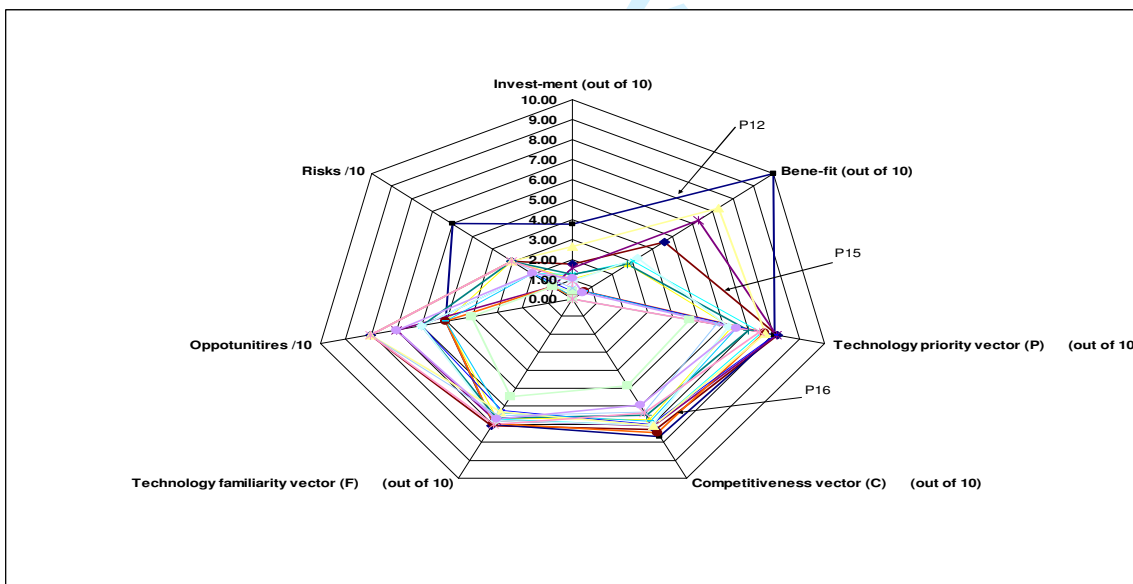

Figure 10: Radar diagram showing fifteen projects (P11 to P25)

Developers	Scope
EIRMA (European Industrial Research Management Association)	Time, product/process characteristics, technologies, skills, science, know-how and resources (EIRMA 1997).
Northwestern University	Market, product and technology, plus a summary to explain action plan and risks.
Cambridge University (T-Plan)	Market, products, technology, resources, customisation of the standard process.
Purdue University Centre for Technology Roadmapping	Web-based technology roadmapping system, made available to research organizations, individuals and industry associations. The resultant roadmaps are retained and made accessible for further research.
University of Nottingham Responsive Manufacturing Group	Technology roadmapping with a focus on R&D investment in manufacturing technology.

**Table I: Examples of roadmapping methodologies**