



HAL
open science

Modelling the spread of Bovine Viral Diarrhoea Virus (BVDV) in a managed metapopulation of cattle herds

Aurélie Courcoul, Pauline Ezanno

► **To cite this version:**

Aurélie Courcoul, Pauline Ezanno. Modelling the spread of Bovine Viral Diarrhoea Virus (BVDV) in a managed metapopulation of cattle herds. *Veterinary Microbiology*, 2010, 142 (1-2), pp.119. 10.1016/j.vetmic.2009.09.052 . hal-00578408

HAL Id: hal-00578408

<https://hal.science/hal-00578408>

Submitted on 20 Mar 2011

HAL is a multi-disciplinary open access archive for the deposit and dissemination of scientific research documents, whether they are published or not. The documents may come from teaching and research institutions in France or abroad, or from public or private research centers.

L'archive ouverte pluridisciplinaire **HAL**, est destinée au dépôt et à la diffusion de documents scientifiques de niveau recherche, publiés ou non, émanant des établissements d'enseignement et de recherche français ou étrangers, des laboratoires publics ou privés.

Accepted Manuscript

Title: Modelling the spread of Bovine Viral Diarrhoea Virus (BVDV) in a managed metapopulation of cattle herds

Authors: Aurélie Courcoul, Pauline Ezanno

PII: S0378-1135(09)00469-6
DOI: doi:10.1016/j.vetmic.2009.09.052
Reference: VETMIC 4609

To appear in: *VETMIC*



Please cite this article as: Courcoul, A., Ezanno, P., Modelling the spread of Bovine Viral Diarrhoea Virus (BVDV) in a managed metapopulation of cattle herds, *Veterinary Microbiology* (2008), doi:10.1016/j.vetmic.2009.09.052

This is a PDF file of an unedited manuscript that has been accepted for publication. As a service to our customers we are providing this early version of the manuscript. The manuscript will undergo copyediting, typesetting, and review of the resulting proof before it is published in its final form. Please note that during the production process errors may be discovered which could affect the content, and all legal disclaimers that apply to the journal pertain.

17 **Abstract (172 words)**

18 In numerous epidemiological models developed within a metapopulation framework, it is
19 assumed that a single infected individual introduced into a patch infects the whole patch
20 and that the proportion of infected individuals into infected patches is consistent over time
21 and among patches. If this approach is relevant for rapidly-spreading pathogens, it is less
22 appropriate for moderately-spreading pathogens, like the Bovine Viral Diarrhoea Virus
23 (BVDV), characterized by a variability in within-patch prevalence. Our objective is to
24 study the respective influence of neighbouring relationships and animal movements on the
25 spread of BVDV in a managed metapopulation of 100 cattle herds. Infection dynamics is
26 represented by two coupled stochastic compartmental models in discrete time: a within-
27 herd and a between-herd models. Animal movements are mechanistically modelled. They
28 largely influence the BVDV persistence, the prevalence in infected herds and the epidemic
29 size. Neighbouring relationships only influence epidemic size. Whatever the neighbouring
30 relationships, the infection does not persist in the metapopulation without animal
31 movement between herds. The proposed model can be easily adapted for different herd
32 contact structures.

33

34 **Keywords: contact network, structured population, epidemic model, migration,**
35 **pestivirus, livestock.**

36

36 **1. Introduction**

37 Bovine Viral Diarrhoea Virus (BVDV) is a pathogen of major concern in Europe. BVDV
38 infection is widespread among cattle herds (Houe, 1999). Of considerable economic impact
39 (Houe, 2003), it is characterized by abortions or congenital deformities, induces milk
40 production losses and growth delays, and increases occurrence of other diseases. As an
41 example, the total annual losses were estimated in Denmark to US\$ 20 millions in 1992
42 (Houe, 1999), while the annual incidence of acute infections was estimated to 34%. To
43 limit BVDV spread and its consequences, control strategies are implemented in several
44 regions in Europe (Greiser-Wilke et al., 2003; Lindberg et al., 2006). However, their
45 efficiency is hard to evaluate or to compare to each other by field observations because no
46 reference situations (without control) is generally available, and because observations on
47 the long term should be performed, which is costly and sometimes unfeasible. Modelling is
48 then a convenient approach to evaluate control strategies of BVDV spread. However, at a
49 regional level, i.e. taking into account interactions between herds, no model of BVDV
50 spread between cattle herds is available yet.

51 Between herds, BVDV spreads mainly through purchases of animals carrying the virus
52 (equivalent to migration or movement in unmanaged systems) and through neighbouring
53 relationships between infected and BVDV-free herds (Lindberg and Alenius, 1999). There
54 are three types of animals carrying the virus. Two types are infectious animals: persistently
55 infected (PI) immunotolerant animals shed the virus in large amounts during their whole
56 life, whereas transiently infected (TI) animals shed the virus in low amounts during a few
57 days (Tremblay, 1996; Houe, 1999). The third type consists of pregnant cows that have
58 been infected and that may carry a PI foetus due to vertical transmission (Fray et al., 2000).

59 Such cows are immune and thus hard to detect by diagnostic tests (Lindberg et al., 2001).
60 The probability to purchase an animal carrying the virus is directly related to the within-
61 herd prevalence in the source herd and to the characteristics of the control strategies
62 implemented (if some are implemented), such as detection tests which can be performed at
63 purchases. If the characteristics of such tests are well known (Beaudeau et al., 2001; Baxi et
64 al., 2006), the within-herd prevalence of infected animals is variable over time and among
65 infected herds. Moreover, introducing an infected animal into a herd does not necessarily
66 lead the infection to spread in that herd (Ezanno et al., 2008). Hence, infected herds
67 heterogeneously contribute to the BVDV regional spread. In terms of control, it may lead to
68 specific issues, as strategies efficiency might be largely influenced by the within-herd
69 prevalence and its variability.

70

71 At a regional scale, a population of cattle herds forms a metapopulation, defined as a set of
72 unstable local populations living each on discrete patches of habitat connected by migrants
73 (Hanski, 1998). A metapopulation dynamics is based on a balance between patch extinction
74 and subsequent patch recolonisation by dispersing individuals. This concept is well-known
75 in ecology and genetics to study dynamics of fragmented populations and gene flow in
76 heterogeneous landscapes (Grenfell and Harwood, 1997). Each metapopulation has its own
77 contact structure. Four types of contacts can be distinguished: migrations or dispersal (an
78 individual moves from one patch to another and does not come back to the initial patch),
79 neighbourhood (individuals in patch i have contacts with individuals in patch k but no
80 individual leaves its own patch), visits (an individual leaves its patch, reaches another one

81 and then comes back to its initial patch) and indirect contacts (individuals do not meet, the
82 pathogen being transmitted by an inert or animal vector or by the air).

83 Recently, epidemiological models have been developed in this framework, taking into
84 account infection dynamics of patches in addition to an extinction-recolonisation balance.

85 In such an approach, each patch is a potential localization for a group of hosts. Hess (1996)
86 was a precursor by conceptualising an epidemiological model based on the Levin's model:
87 migrations of infected individuals were a source of infection for healthy populations. With
88 such a model, the persistence of a metapopulation in the presence of a pathogen can be
89 studied (Hess, 1996; Gog et al., 2002; McCallum and Dobson, 2002). Currently, this kind
90 of models is often used to study pathogen spread and persistence in connected populations,
91 particularly for rapidly-spreading animal diseases such as Avian Influenza (Le Menach et
92 al., 2006). In this case, the infection dynamics is represented at the metapopulation level in
93 a deterministic way without care about what exactly happens within each patch. It is thus
94 assumed that introducing one infected individual into a patch is sufficient to lead to
95 infecting this patch and that the prevalence of infection (proportion of infected individuals)
96 in infected patches is consistent over time (the equilibrium is immediately reached) and
97 among infected patches. If this argument seems adequate for rapidly-spreading pathogens,
98 we can wonder what happens for moderately-spreading pathogens. For example, an
99 infected individual with bovine tuberculosis can disappear long before infecting
100 congenetics. In such a case, infectious statuses have to be defined at the individual level
101 and the within-patch infection dynamics has to be modelled (Jesse et al., 2008). This
102 approach is all the more relevant when heterogeneity in the within-patch infection process
103 is assumed, either over time or among patches (Hess, 1996; Park et al., 2002; Cross et al.,

104 2005). If this kind of models better reflects the variety of situations, it is far more complex.
105 Nevertheless, a lot of major animal pathogens spread moderately, such as BVDV. When
106 studying the spread of such a pathogen, well-adapted epidemiological models have to be
107 developed.

108

109 The objective of this paper is to represent the spread of BVDV in an initially fully
110 susceptible metapopulation of cattle herds. The respective influence of animal movements
111 and neighbouring relationships on the regional BVDV spread and persistence is evaluated
112 using a modelling approach. Such an approach allows to better understand the dynamics of
113 this moderately-spreading, to test a wide range of situations and to evaluate the influence of
114 unobservable parameters.

115

116 **2. The modelling approach**

117 We consider a metapopulation of n small animal populations, each inhabiting a distinct
118 habitat patch. Patches are assumed to be connected by migrations of animals and by
119 neighbouring contacts between patches. Space is assumed to be homogeneous and
120 populations to all have the same number of neighbours.

121 Here we assumed that the within-patch pathogen spread varies among infected patches.

122 Actually, a newly infected animal can quickly disappear (mortality, recovery, migration to
123 another patch) or persist for a long time in a given patch. To take into account this
124 heterogeneity in the within-patch force of infection and the potential effect it may have on
125 the global infection dynamics at the metapopulation level, a within-patch model is coupled
126 with a between-patch model (Fig. 1).

127 Within a patch, a population can be structured into different groups with different contact
 128 structure. For example, young individuals of an age-structured population can be assumed
 129 neither to migrate nor to have neighbouring contacts. Such a population structure influences
 130 the within-population spread of pathogens (Keeling and Rohani, 2008) and should be
 131 accounted for to model the within-patch infection dynamics.

132 As populations are small, the model is stochastic. The resulting model is a patch-based
 133 model in discrete-time, the state of each patch at time t being defined by the number of
 134 animals per health status and per group at this time in the patch. For example, for a SIR
 135 (susceptible / infected / recovered) within-patch model in a population structured into
 136 groups, the local probability of infection in patch (or population) X in group l at time t
 137 depends on the within-group infection process and on the between-group probability of
 138 transmission. Assuming a frequency-dependent infection function, this can be written as:

$$139 \quad p_l^X(t) = 1 - \exp\left(-\Delta\left(\frac{\beta_w I_l^X(t)}{N_l^X(t)} + \sum_{g \neq l, g \in X} \frac{\beta_b I_g^X(t)}{N_g^X(t) N_l^X(t)}\right)\right), \quad (1)$$

140 with β_w the within-group transmission rate of the infection between an infectious and a
 141 susceptible animal, β_b the between-group transmission rate, Δ the length of the time step, g
 142 a group other than group l also belonging to population X , $I_g^X(t)$ the number of infectious
 143 animals in group g in population X at time t , $N_g^X(t)$ the total number of animals in group g
 144 in population X at time t . The between-group transmission function takes into account both
 145 the influenced and the influencing populations. This is convenient in order to model
 146 indirect transmission, by contaminated material for example. In such a case, only a fraction
 147 of population encounters the contaminated material. Hence, the probability of infection per

148 individual depends on the size of the influenced population. Such an infection function has
 149 been proposed to model epidemics in highly mobile populations (Ögren and Martin, 2002),
 150 as well as for modelling the spread of a pathogen in a cattle herd (Ezanno *et al.*, 2007),
 151 which is typically structured into groups (feedlots, reproductive groups, etc.).
 152 Between patches, the pathogen can locally spread by neighbouring contacts. This could be
 153 the case when patches of habitat are contiguous or when a common resource (such as a
 154 temporary pool) is used by several populations. The probability of infection of patch X by
 155 neighbouring relationships is assumed to depend on the prevalence of the infection in
 156 neighbouring populations and to be frequency-dependent:

$$157 \quad P_n^X(t) = 1 - \exp \left(- \beta_n \Delta \frac{\sum_{Y \in \zeta_X} I^Y(t)}{N^X(t) \sum_{Y \in \zeta_X} N^Y(t)} \right), \quad (2)$$

158 with β_n the transmission rate between an infectious animal and a susceptible one belonging
 159 to neighbouring patches, ζ_X the set of neighbours of patch X , $I^Y(t)$ the number of infectious
 160 animals in patch Y at time t , and $N^Y(t)$ the total number of animals in patch Y at time t . As
 161 for the between-group within-population transmission, the proposed function takes into
 162 account the sizes of both the influenced and the influencing populations. Here again, only a
 163 fraction of the animals from a herd are influenced by infected animals from neighbouring
 164 herds at each time period. Contacts between neighbouring herds may involve for example
 165 uncontrolled movements of susceptible animals (escape) or contacts above the fence at
 166 pasture influenced by the available space. Hence, the function has to combine the

167 probability of encountering infected animals of the herd a ($k \frac{P_t^a}{N_t^a}$) and the probability for a
 168 susceptible animal in herd l to be in contact with it ($\frac{\beta_n}{k} \frac{1}{N_t^l}$).

169 Moreover, a global spread of the pathogen between patches is due to migrations of
 170 individuals. Here, explicit movements are modelled using a complete random network, i.e.
 171 animals from a patch can go to any other patches. Actually, in a small patch infected with a
 172 moderately-transmitted pathogen, the prevalence of infection can be low. The movement of
 173 a single individual can thus influence the infection dynamics in both source and destination
 174 patches, especially if the moving individual is the only infected one in its source patch. We
 175 assume that there is no infection during the migration process, i.e. migrants form a pool of
 176 individuals without any contact with other individuals or with each other (Fig. 1).

177

178 **3. Application to BVDV spread between cattle herds**

179 *3.1. Main characteristics of BVDV infection*

180 BVDV is a pestivirus which does not survive well in the environment (Tremblay, 1996).
 181 Direct contacts between animals are then required for transmission of the infection. Thus,
 182 animal purchases and contacts at pasture between animals of neighbouring herds (contact
 183 above the fence or pasture on common land areas) are the most important ways of
 184 introducing BVDV into a herd (Lindberg and Alenius, 1999). Potential introductions by
 185 people or equipment, inoculations during vaccination, artificial reproduction (sperm or
 186 embryos) or insects are assumed to have a negligible impact (Tremblay, 1996).

187 The virus can also be vertically transmitted. Foetuses infected in utero by their mother
188 infected between 40 and 125 days of pregnancy become persistently infected (PI) animals.
189 They shed the virus in large amounts during their whole life (Tremblay, 1996). Moreover,
190 PI dams give birth to PI calves. On the contrary, transiently infected (TI) animals have been
191 horizontally infected. They shed the virus in low amounts during a few days (Houe, 1999).
192 Afterwards, they are considered resistant for their whole life (Brownlie *et al.*, 1987). Their
193 epidemiological importance is generally considered to be weak except that transient
194 infection occurring during the first third of gestation can lead to the future birth of a PI calf,
195 the dam certainly becoming resistant.

196

197 *3.2. Within-herd model*

198 The within-herd model is described in details in Ezanno *et al.* (2007). It is a stochastic
199 compartmental model in discrete-time that represents the BVDV spread in a dairy herd.

200 The herd is structured in 5 groups of animals (calves, young heifers, heifers, lactating cows
201 and dry cows). Animals change groups function of their age and their physiological state.

202 The two kinds of infectious individuals are represented : transiently infected (T) and
203 persistently infected (P). A diagram of this model as well as the related equations are
204 published elsewhere (Ezanno *et al.*, 2007).

205 Direct horizontal transmission occurs between PI or TI animals and susceptible ones of the
206 same group and between PI and susceptible animals of different groups. By extending
207 equation (1) to model the local probability of BVDV infection in population X for group l ,
208 we have:

$$209 \quad P_l^X(t) = 1 - \exp \left(- \Delta \left(\frac{\beta_w^P P_l^X(t)}{N_l^X(t)} + \frac{\beta_w^T T_l^X(t)}{N_l^X(t)} + \sum_{g \neq l, g \in X} \frac{\beta_b^P P_g^X(t)}{N_g^X(t) N_l^X(t)} \right) \right)$$

210 considering the same notations as in equation (1) and with β_w^P the within-group
 211 transmission rate for PI animals, β_w^T the within-group transmission rate for TI animals, β_b^P
 212 the between-group transmission rate only due to PI animals, $Z_g^X(t)$ the number of animals
 213 of status Z in group g in population X at time t , and $N_g^X(t)$ the total number of animals in
 214 group g in population X at time t .

215

216 3.3. Between-herd model

217 We consider a metapopulation of 100 dairy herds assimilated to patches with two ways of
 218 contacts between those patches: neighbouring contacts and animal purchases (comparable
 219 to between-patch migrations).

220 As observed in the field (Ezanno *et al.*, 2006), each dairy herd buy a given number of
 221 heifers per year, the source herd being chosen randomly for each purchase. Animal
 222 purchases lead to a random network structure.

223 The neighbouring contact structure is stated initially and is kept identical over time and for
 224 all realizations of a given scenario. It is a symmetric structure (if A is B neighbour, then B
 225 is A neighbour). For each herd, neighbours are selected among all herds, without
 226 accounting for between-herd distances. As only a small region with a few herds is
 227 modelled, distance is not highly influential. Actually, pastures of a given herd can be
 228 anywhere in the modelled area and thus can be in the neighbourhood of any other herd. As
 229 a result, due to such a fragmented farming landscape, pastures of a given herd can be in the

230 neighbourhood of pastures of two herds which have no contact with each other (A is the
 231 neighbour of B and C, without B and C being neighbours). Hence, the chosen structure is
 232 not transitive. However, the model can be easily adapted to other contact structures,
 233 including a distance-dependent or transitive network structure, by initially specifying the
 234 matrix of neighbouring contacts.

235 Neighbouring contacts are assumed to occur from mid-March to mid-November. Only dry
 236 cows, heifers and young heifers over 6 months are grazing and thus may have neighbouring
 237 contacts. We assume that only PI animals shed the virus in sufficient amount to give rise to
 238 infection of their neighbours at pasture. By extending equation (2) to model the probability
 239 of infection of patch X by neighbouring relationships, we have:

$$240 \quad P_n^X(t) = 1 - \exp \left(- \beta_n \Delta \frac{\sum_{Y \in \zeta_X} P_o^Y(t)}{O^X(t) \sum_{Y \in \zeta_X} O^Y(t)} \right)$$

241 considering the same notation as in equation 2 and with β_n the transmission rate between a
 242 PI animal and a susceptible one belonging to neighbouring patches, $P_o^Y(t)$ the number of PI
 243 animals at pasture in patch Y at time t , and $O^Y(t)$ the total number of animals at pasture in
 244 patch Y at time t .

245

246 *3.4. Parameters and initial conditions*

247 Initially, every herds are of the same size, being composed each of 85 animals (45 cows, 20
 248 heifers and the associated young stock). The size varies over time but each herd cannot
 249 have more than 60 cows and/or 25 heifers, numbers above which cows or heifers randomly

250 leave the herd. Demographic parameters (birth, mortality, slaughter, achievement in AI) are
251 the same for all herds. They are chosen to represent typical Holstein dairy herds (see
252 Ezanno *et al.* (2007) for more details). For sake of simplicity, we assume that all herds
253 introduce the same number of heifers per year and have the same number of neighbours.
254 Because no information is available to rationalize the value taken for the rate of BVDV
255 transmission at pasture, it is taken to be equal to the between-group transmission rate within
256 a herd because both events are closely related. As a result, the within-group within-herd
257 transmission rates are equal to 0.50 and 0.03 per day for the PI and TI animals,
258 respectively. The between-group and between-herd transmission rates are equal to 0.10 per
259 day (transmission only due to PI animals).

260 BVDV is initially introduced in a fully susceptible metapopulation by the purchase of a PI
261 heifer in one herd. No re-introduction is further allowed.

262

263 3.5. Scenarii

264 Three neighbouring contact structures (0, 5 or 10 neighbours per herd) and five purchase
265 intensities (0, 2, 5, 7 or 10 heifers yearly purchased per herd) are modelled to study their
266 relative influence on the regional spread of BVDV, leading to a total of fifteen scenarii. The
267 reference scenario is '5 neighbours per herd and 2 purchases per year per herd'.

268 For each scenario, 150 realizations are run, which is enough to stabilize model outputs
269 (results not shown). We simulate the evolution of the system over a 15-year period. It has to
270 be noted that studying such a managed system on a longer term will not be appropriate
271 because herd structure and management obviously change on such a time scale.

272

273 *3.6. Output*

274 First, we observe the influence of stochastic events on the modelled system by comparing
275 two almost extreme realizations of the reference scenario and the global average of the
276 number PI animals over time in the metapopulation.

277 Second, we analyse the probability of persistence of the metapopulation infection (equal for
278 each scenario at any time interval to the proportion of realizations for which the virus is still
279 present in the metapopulation), the distribution of the metapopulation infection duration
280 and the related probability of pathogen endemicity (assumed when the pathogen persists
281 more than 10 years in the metapopulation), the mean number of infected herds over time in
282 a metapopulation still infected, and the distribution over all realizations of the epidemic size
283 in infected herds (cumulated number of herds that have been infected for at least one time
284 interval).

285

286 **4. Results**

287 As the model is stochastic, the infection dynamics is variable both over time and among
288 realizations for a given scenario. The infection can disappear in a few years or persist over
289 a long time with a high number of persistently infected animals in the metapopulation (as
290 shown for example for the reference scenario in Fig. 2). In the reference scenario, the
291 prevalence of PI animals in the metapopulation reaches a pseudo-equilibrium equal to 8%.

292 The infection does not persist in the metapopulation when no animals are purchased (Fig.
293 3), whereas the probability of persistence is high and maintains over time when animals are
294 purchased. The number of animals that are purchased does not influence the probability of

295 persistence, which is almost the same for 2 to 10 animals yearly purchased per herd (results
296 not shown).

297 Animal purchases also highly influence the duration of the metapopulation infection
298 (Fig. 4a). This duration is shorter without purchases (on average 4.6 years) than with
299 purchases (on average 10.8 years), whatever the number of neighbours. The median
300 duration increases with the number of purchased animals until reaching a maximum
301 duration (equal to the simulated period) after which increasing further the number of
302 purchased animals slightly decreases the median duration (here obtained for 10
303 purchases/year/herd). On the contrary, the neighbouring contacts do almost not influence
304 this output. The related probability of pathogen endemicity is lower than 6% when no
305 animal is purchased, whereas it is larger than 50% when animals are purchased (Fig. 4b),
306 whatever the number of animals purchased and the number of neighbours per herd.

307 Without purchase, the mean number of infected herds in an infected metapopulation
308 decreases to reach extinction on average in 10 years, without any influence of neighbouring
309 contacts (Fig. 5). On the contrary when animals are purchased the average number of
310 infected herds in an infected metapopulation reaches an pseudo-equilibrium, the herd level
311 prevalence being almost equal to 5%. The presence of neighbours slightly increases this
312 prevalence (Fig. 5).

313 Both increasing neighbouring contacts and increasing purchases increase the herd epidemic
314 size (Fig. 6). The median epidemic size only slightly increases with the number of
315 neighbours per herd. However, the number of realizations showing an extreme epidemic
316 size (queue of the distribution) increases with the number of neighbours per herd (Fig. 6).
317 Moreover, until 7 animals are purchased per herd per year, the more animals are purchased,

318 the larger is the epidemic size. As the median infection duration, the epidemic size slightly
319 decreases for a large number of purchases (10 purchases/year/herd).

320

321 **5. Discussion**

322 *5.1 The modelling approach*

323 A stochastic compartmental model in discrete time is proposed, which couples within- and
324 between-patch infection dynamics in a metapopulation framework. Because the model is
325 stochastic, different evolutions of the system over time for a given scenario are possible:
326 the infection can early disappear or persist with a variable number of infected patches and
327 infected individuals. This type of dynamics is important for pathogens which spread
328 moderately in a heterogeneous way, especially in small-size patches in which stochastic
329 events have a major impact (Jesse *et al.*, 2008). However, for such realistic a model, the
330 running time becomes important. Concerning BVDV, it has been shown that the herd
331 structure largely influences the pathogen spread within a herd (Ezanno *et al.*, 2008).
332 Therefore, the within-herd infection and population dynamics should be explicitly
333 modelled. Furthermore, the between-patch contact structure is related to both neighbouring
334 relationships and mechanistically modelled individual migrations. In order to clearly
335 evaluate the effect of both these types of between-patch contact on pathogen spread and
336 persistence, independently of other possible causes of persistence, no reintroduction of the
337 virus in the metapopulation is allowed. Accounting for an external source of infection
338 would have largely contributed to the pathogen persistence (e.g. Fromont *et al.*, 2003; Gog
339 *et al.*, 2002), and would have been appropriate if a pathogen surviving in the environment
340 had been modelled. Actually, for such indirectly transmitted pathogens, a delay may appear

341 between environment contamination and subsequent animal infection, which can occur
 342 even if no infected animal is present. However, in case of directly transmitted pathogens, it
 343 would have led to quite an artificial persistence of the pathogen. For the model to be
 344 extended to the case of indirectly transmitted pathogens, the transmission function should
 345 be modified and a compartment stating the level of environment contamination over time
 346 should be added (e.g. in livestock pathogens within a managed herd, Lurette et al., 2008).

347 In addition, the way subpopulations influence each other is generally modelled with a

348 frequency-dependent function of the form $\lambda_i = \sum_{j=1}^{j=n} \beta_{ij} \frac{I_j}{N_j}$, with β_{ij} the transmission rate

349 between subpopulation i and j , I_j the number of infected individuals in subpopulation j and

350 N_j the total number of individuals in subpopulation j . If such a function has the convenient

351 property of simplifying in case of just one subpopulation to the function of the unstructured

352 model, it seems inappropriate when subpopulations greatly differ in size (Ogren and

353 Martin, 2002). In case of travelling between subpopulations, the fraction of travellers from

354 the source population has to be taken into account as well as the proportion of infected

355 individuals in the destination population. Ogren and Martin (2002) propose the following

356 function: $\lambda_i = \sum_{j=1}^{j=n} \beta_{ij} \frac{1}{N_i} \frac{I_j}{N_j}$, with $\beta_{ij} = \beta M_{ij}$, M_{ij} being the number of travellers between

357 subpopulations i and j . Such a function takes into account the sizes of both the influenced

358 and the influencing populations. In case of managed herds, herd sizes vary among herds.

359 Moreover, not all the animals from a herd are influenced by infected animals from

360 neighbouring herds at each time period. Hence, such a function appears to be appropriate to

361 model the between-herd transmission when direct contacts between animals are involved.

362 In the absence of knowledge on the intensity of contacts over the fence at pasture, the
363 between-group transmission rate is assumed to be the same within-herd and between-herd.
364 However, within a herd, between-group transmission involves indirect contacts like
365 contaminated equipments, whereas between herds, direct contacts are concerned during
366 which transmission is frequent. This can lead to underestimate the probability of infection
367 at pasture.

368 The neighbouring contact structure is a symmetric structure but not a transitive one (even if
369 A is the neighbour of B and C, B and C have not a higher probability of being neighbours).
370 It is kept identical over time and for all realizations of a given scenario. As only a small
371 region with a few herds is modelled, distance can be assumed not to be highly influential.
372 In addition, in farms, pastures are often scattered in the countryside and sometimes located
373 far from the farm. Hence, even if A has a pasture contiguous to one of farm B and another
374 contiguous to one of farm C, B and C are likely not to have neighbouring pastures. As a
375 result, we do not represent space as continuous or as a grid made of contiguous cells of
376 habitat, but place our modelling work in the metapopulation framework. In such a
377 framework, moreover, no edge effect are encountered as space is not explicitly modelled. In
378 contrast, in ecology, patches can be spatially aggregated in clusters (Matthews *et al.* 2003;
379 Favier *et al.*, 2005), and distance may play a major role in pathogens spread (Keeling *et al.*,
380 2001), as for example in vector-borne diseases (Tran and Raffy, 2006). Therefore, for areas
381 of larger sizes or for a biological system explicitly related to space, the proposed model
382 should be extended to represent geographical clusters, i.e. sets of patches in which
383 neighbourhood contacts are more frequent, which could be more spatially realistic. Such an

384 explicit representation of space can be easily incorporated in our model by modifying the
385 neighbouring matrix.

386 In our approach, we consider a homogeneous exposure to infection at pasture due to
387 neighbouring relationships. We assume that all individuals from a given patch are
388 consistently exposed to infectious individuals of all neighbours. This assumption is
389 appropriate if contacts between individuals from neighbouring patches occur because
390 individuals all use a common resource such as water, food or cover, because of random
391 local movements of individuals among neighbouring patches, or because of frequent
392 changes in neighbours. Here, we are in this latter case, pasture turn-over leading to
393 homogenizing infection exposure at pasture. However, in some other cases, the contact
394 related to neighbouring relationships may be heterogeneous, some specific groups of
395 individuals from a patch meeting some specific groups from other patches. This is
396 particularly true concerning wild structured populations, for example because of sexual
397 segregation such as in deer (Bonenfant *et al.*, 2004) which leads to a heterogeneous contact
398 structure between males and females.

399

400 Like in the island model of Hess (1996), animal movements are random in the proposed
401 model, such that each patch can be reached from any other patch. This assumption is realistic
402 here as more than 90% of the pairs between dairy herds which do not have any fattening
403 unit on a given year are not renewed the next year (Ezanno *et al.*, 2006). Hence, there is no
404 preference in animal exchanges. However, in some managed populations, herds can sell
405 (buy) animals preferentially to (in) given herds. Some authors thus consider that individuals
406 migrate between patches function of the localization (Matthews *et al.* 2003) or the carrying

407 capacity (Fulford *et al.* 2002) of patches. Such a random pattern in animal movements can
408 be adapted to more specific networks by specifying the purchase / movement matrix: for
409 each herd, a set of herds is defined in which animals can be purchased. This would improve
410 the model realism when animal movements are not random (Keeling and Eames, 2005).

411

412 *5.2 BVDV spread and persistence*

413 The model has been applied to modelling the spread of BVDV in a bovine metapopulation
414 in order to study the persistence of such a directly transmitted and moderately-spreading
415 pathogen. When only neighbouring relationships are involved in the between-herd contact
416 structure, the infection does not persist within a metapopulation of 100 dairy herds without
417 fattening units. Purchases are required. However, even with few animal movements and
418 assuming no further reintroduction of the pathogen after the initial contamination of the
419 metapopulation, the infection highly persists over time, which is coherent with field
420 observations. In Brittany (France) for example, BVDV infection is assumed to be endemic
421 and even dairy herds introducing almost no animal may be infected (Joly, pers. comm.
422 2007).

423 A non linear relationships between the median epidemic duration and animal movements
424 has been recently highlighted using a stochastic SIR model in metapopulation (Jesse *et al.*,
425 2008). The median epidemic duration first increases with an increasing movement rate,
426 then decreases for intermediate values until the movement rate becomes large enough to
427 permit an endemic behaviour of the infection. Here, we observe the same tendency using a
428 far more complex model applied to a realistic biological system and pathogen, even for
429 only very few between-herd animal movements.

430 In the model, the prevalence of infected herds within the metapopulation is lower than 6%.
431 This is consistent with field observations made in Brittany (France): before control
432 strategies have been implemented, around 10% of the dairy herds (with and without
433 fattening units) had at least one persistent infected animal (Joly, pers. comm. 2007).
434 Moreover, in most infected herds, the prevalence of infected individuals is low, which
435 could have consequences on virus screening. A large number of animals should be tested
436 before ensuring an area to be BVDV-free. In the model, if the average herd level and
437 individual level prevalences are low, they highly vary among realizations of a given
438 scenario. This is consistent with literature: from 37 to 100% of the herds of a country could
439 contain seropositive animals (Houe, 1999). Hence, our model catches the heterogeneity in
440 the BVDV dynamics in a realistic way.

441

442 *5.3 Application to BVDV control*

443 We study how neighbouring contacts and animal movements may influence the dynamics
444 of a moderately spreading pathogen in a metapopulation, applied to BVDV spread among
445 dairy herds. Our model shows that animal movements highly contribute to the persistence
446 of the infection and to the herd level prevalence. Without any purchase, the average number
447 of infected herds in an infected metapopulation decreases and extinction may be reached in
448 less than 10 years, whereas only few animal movements are needed to lead the infection to
449 persist. However, animals of any health states are allowed to be exchanged between herds,
450 whereas control strategies may be implemented in the field to reduce the risk of introducing
451 infected animals within uninfected herds. In fact, preventing re-introduction of the infection
452 in free herds because of movements of animals is one of the central elements of control

453 strategies (Lindberg *et al*, 2006). This can be achieved by defining herd status towards
454 BVDV and by introducing trade regulations for such certified herds: the latter have to buy
455 animals only in herds of equivalent or better status. Testing individuals before purchase is
456 another way to prevent from introducing PI animals. It seems therefore valuable to further
457 evaluate such strategies using a modelling approach, especially in the case of endemic
458 infection. In particular, whereas neighbouring relationships have been shown here to only
459 slightly influence BVDV epidemic size, we can wonder if their influence will change when
460 certification of herds or tests on purchased animals will be systematically implemented.

461

462 **6. Acknowledgments**

463 This work was carried out with the financial support of the « ANR- Agence Nationale de la
464 Recherche - The French National Research Agency » under the « Programme Agriculture
465 et Développement Durable », project « ANR-05-PADD-014, ACDUQ ». The authors
466 would like to thank F. Beaudeau and H. Seegers for valuable comments on this paper.

467

468 **7. Conflict of interest statement**

469 None.

470

471 **8. References**

472 Baxi M., McRae D., Baxi S., Greiser-Wilke I., Vilcek S., Amoako K., Deregt D. 2006. A
473 one-step multiplex real-time RT-PCR for detection and typing of bovine viral diarrhea
474 viruses. *Vet. Microbiol.* **116**, 37–44.

- 475 Beaudreau F., Belloc C., Seegers H., Assié S., Sellal E., Joly A. 2001. Evaluation of a
476 blocking ELISA for the detection of bovine viral diarrhoea virus (BVDV) antibodies in
477 serum and milk. *Vet. Microbiol.* **80**, 329-337.
- 478 Bonenfant C., Loe L.E., Mysterud A., Langvatn R., Stenseth N.C., Gaillard J-M., Klein F.
479 2004. Multiple causes of sexual segregation in European red deer: enlightenments from
480 varying breeding phenology at high and low latitude. *Proc. R. Soc. Lond. B* **271**, 883–
481 892.
- 482 Brownlie J, Clarke MC, Howard CJ, Popock DH. 1987. Pathogenesis and epidemiology of
483 bovine virus diarrhoea virus infection of cattle. *Ann. Rech. Vét.* **18**, 157-166.
- 484 Cross P.C., Lloyd-Smith J.O., Johnson P.L.F., Getz W.M. 2005. Duelling timescales of
485 host movement and disease recovery determine invasion of disease in structured
486 populations. *Ecol. Lett.* **8**, 587-595.
- 487 Ezanno P., Fourichon C., Beaudreau F., Seegers H. 2006. Between-herd movements of
488 cattle in Bretagne and risk of introducing infected animals. *Anim. Res.* **55**, 189-208.
- 489 Ezanno P., Fourichon C., Seegers H. 2008. Effect of herd structure and type of virus
490 introduction on the spread of bovine viral diarrhoea virus (BVDV) within a dairy herd.
491 *Vet. Res.* **39**:39.
- 492 Ezanno P., Fourichon C., Viet A-F., Seegers H. 2007. Sensitivity analysis to identify key-
493 parameters in modelling the spread of bovine viral diarrhoea virus in a dairy herd. *Prev.*
494 *Vet. Med.* **80**, 49-64.
- 495 Favier C., Schmit D., Müller-Graf C.D.M., Cazelles B., Degallier N., Mondet B., Dubois
496 M.A. 2005. Influence of spatial heterogeneity on an emerging infectious disease: the
497 case of dengue epidemics. *Proc. R. Soc. B* **272**, 1171–1177.

- 498 Fray M.D., Paton D.J., Alenius S. 2000. The effects of bovine viral diarrhoea virus on cattle
499 reproduction in relation to disease control. *Anim. Reprod. Sci.* **60-61**, 615-627.
- 500 Fromont E, Pontier D, Langlais M. 2003. Disease propagation in connected host
501 populations with density-dependent dynamics : the case of the feline leukemia virus. *J.*
502 *Theor. Biol.* **223**, 465-475.
- 503 Fulford GR, Roberts MG, Heesterbeek JAP. 2002. The metapopulation dynamics of an
504 infectious disease : tuberculosis in possums. *Theor. Popul. Biol.* **61**, 15-29.
- 505 Gog J, Woodroffe R, Swinton J. 2002. Disease in endangered metapopulations : the
506 importance of alternative hosts. *Proc. Biol. Sci.* **269**, 671-676.
- 507 Greiser-Wilke I, Grummer B, Moennig V. 2003. Bovine viral diarrhoea eradication and
508 control programmes in Europe, *Biologicals* **31**, 113-118.
- 509 Grenfell BT, Harwood J. 1997. (Meta)population dynamics of infectious diseases. *TREE*
510 **12**, 395-399.
- 511 Hanski I. 1998. Metapopulation dynamics. *Nature* **396**, 41-49.
- 512 Hess G. 1996. Disease in metapopulation models : implications for conservation. *Ecology*
513 **77**, 1617-1632.
- 514 Houe H. 1999. Epidemiological features and economical importance of bovine virus
515 diarrhoea virus (BVDV) infections. *Vet. Microbiol.* **64**, 89-107.
- 516 Houe H. 2003. Economic impact of BVDV infection in dairies. *Biologicals* **31**, 137-143.
- 517 Jesse M., Ezanno P., Davis S., Heesterbeek J.A.P. 2008. A fully coupled, mechanistic
518 model for infectious disease dynamics in a metapopulation: movements and epidemic
519 duration. *J. Theor. Biol.* (in press).

- 520 Keeling M.J., Eames K.T.D. 2005. Networks and epidemic models. *J. R. Soc. Interface* **2**,
521 295–307.
- 522 Keeling M.J., Rohani P. 2008. Modeling infectious diseases in humans and animals.
523 Princeton University Press, Princeton, USA.
- 524 Keeling M.J., Woolhouse M.E.J., Shaw D.J., Matthews L., Chase-Topping M., Haydon
525 D.T., Cornell S.J., Kappey J., Wilesmith J., Grenfell B.T. 2001. Dynamics of the 2001
526 UK Foot and Mouth Epidemic: Stochastic Dispersal in a Heterogeneous Landscape.
527 *Science* **294**, 813.
- 528 Le Menach A, Vergu E., Grais R.F., Smith D.L., Flahault A. 2006. Key strategies for
529 reducing spread of avian influenza among commercial poultry holdings: lessons for
530 transmission to humans. *Proc. R. Soc. B.* **273**, 2467–2475.
- 531 Lindberg A., Alenius S. 1999. Principles for eradication of bovine viral diarrhoea virus
532 (BVDV) infections in cattle populations. *Vet. Microbiol.* **64**,197-222.
- 533 Lindberg A., Brownlie J., Gunn G.J., Houe H., Moennig V., Saatkamp H.W., Sandvik T.,
534 Valle P.S. 2006. The control of bovine viral diarrhoea virus in Europe: today and in the
535 future. *Rev.- Off. Int. Epizoot.* **25**, 961–979.
- 536 Lindberg A., Groenendaal H., Alenius S., Emanuelson U. 2001. Validation of a test for
537 dams carrying foetuses persistently infected with bovine viral diarrhoea virus based on
538 determination of antibody levels in late pregnancy. *Prev. Vet. Med.* **51**, 199–214.
- 539 Lurette A., Belloc C., Touzeau S., Hoch T., Ezanno P., Seegers H., Fourichon C. 2008.
540 Modelling Salmonella spread within a farrow-to-finish pig herd. *Vet. Res.* **39**:49.

- 541 Matthews L., Haydon D.T., Shaw D.J., Chase-Topping M.E., Keeling M.J., Woolhouse
542 M.E.J. 2003. Neighbourhood control policies and the spread of infectious diseases. Proc.
543 Biol. Sci. **270**,1659-1666.
- 544 McCallum H., Dobson A. 2002. Disease, habitat fragmentation and conservation. Proc.
545 Roy. Soc. B **269**, 2041-2049.
- 546 Ögren P., Martin C.F. 2002. Vaccination strategies for epidemics in highly mobile
547 populations. Appl. Math. Comput. **127**, 261-276.
- 548 Park A.W., Gubbins S., Gilligan C.A. 2002. Extinction times for closed epidemics: the
549 effects of host spatial structure. Ecol. Lett. **5**, 747-755.
- 550 Tran A., Raffy M. 2006. On the dynamics of dengue epidemics from large-scale
551 information. Theor. Popul. Biol. **69**, 3–12.
- 552 Tremblay R. 1996. Transmission of bovine viral diarrhea virus. Vet. Med. **91**, 858-866.
553

553 **Figure legends**

554 **Figure 1:** Model diagram for a SIR (susceptible/infectious/recovered) infection dynamics
 555 within patch x structured into juveniles (group 1) and adults (group 2), accounting for
 556 infection within and between groups and for between-patch migrations, with a the mean
 557 juvenile stage duration, b the birth rate, $1/\gamma$ the mean infectious period duration, μ the
 558 mortality rate, p_1^x the infection rate in age class l ($l = 1$ or 2) in patch x , P_n^x the infection
 559 rate by neighbouring contacts in patch x , m_{in} and m_{out} the migration rates into and from a
 560 patch. Migrants form a pool of individuals (Z_l^m for migrants in state Z and group l) having
 561 no contact with each other, mimicking a complete random network.

562 **Figure 2:** Influence of stochastic events on the number of persistently-infected (PI) animals
 563 in the metapopulation over time, as shown by two extreme realizations (thin black and grey
 564 lines) of the reference scenario (5 neighbours and 2 animals purchased per herd per year)
 565 compared to the average over 150 realizations (bold line).

566 **Figure 3:** Probability of infection persistence in the metapopulation according to the
 567 number of neighbours per herd, without purchase vs. with 5 animals purchased per herd per
 568 year.

569 **Figure 4:** Infection duration of the metapopulation: (a) distribution of the duration (in
 570 years) according to the number of animals purchased per herd per year and to the number of
 571 neighbours per herd (–: median; +: average; □: percentile 0.25 to 0.75; O: lowest and
 572 highest values; -: percentile 0.10 and 0.90); (b) probability of endemicity defined as the
 573 proportion of realizations showing an infection duration longer than 10 years.

574 **Figure 5:** Average number of infected herds in a metapopulation still infected according to
575 the number of neighbours per herd, without purchase vs. with 5 animals purchased per herd
576 per year.

577 **Figure 6:** Distribution of the herd epidemic size (cumulative number of infected herds over
578 the simulation period) according to the number of animals purchased per herd per year and
579 to the number of neighbours per herd (–: median; +: average; □: percentile 0.25 to 0.75; O:
580 lowest and highest values; -: percentile 0.10 and 0.90).

581

Accepted Manuscript

581 **Short title for page headings:** BVDV spread in a bovine metapopulation

582

Accepted Manuscript

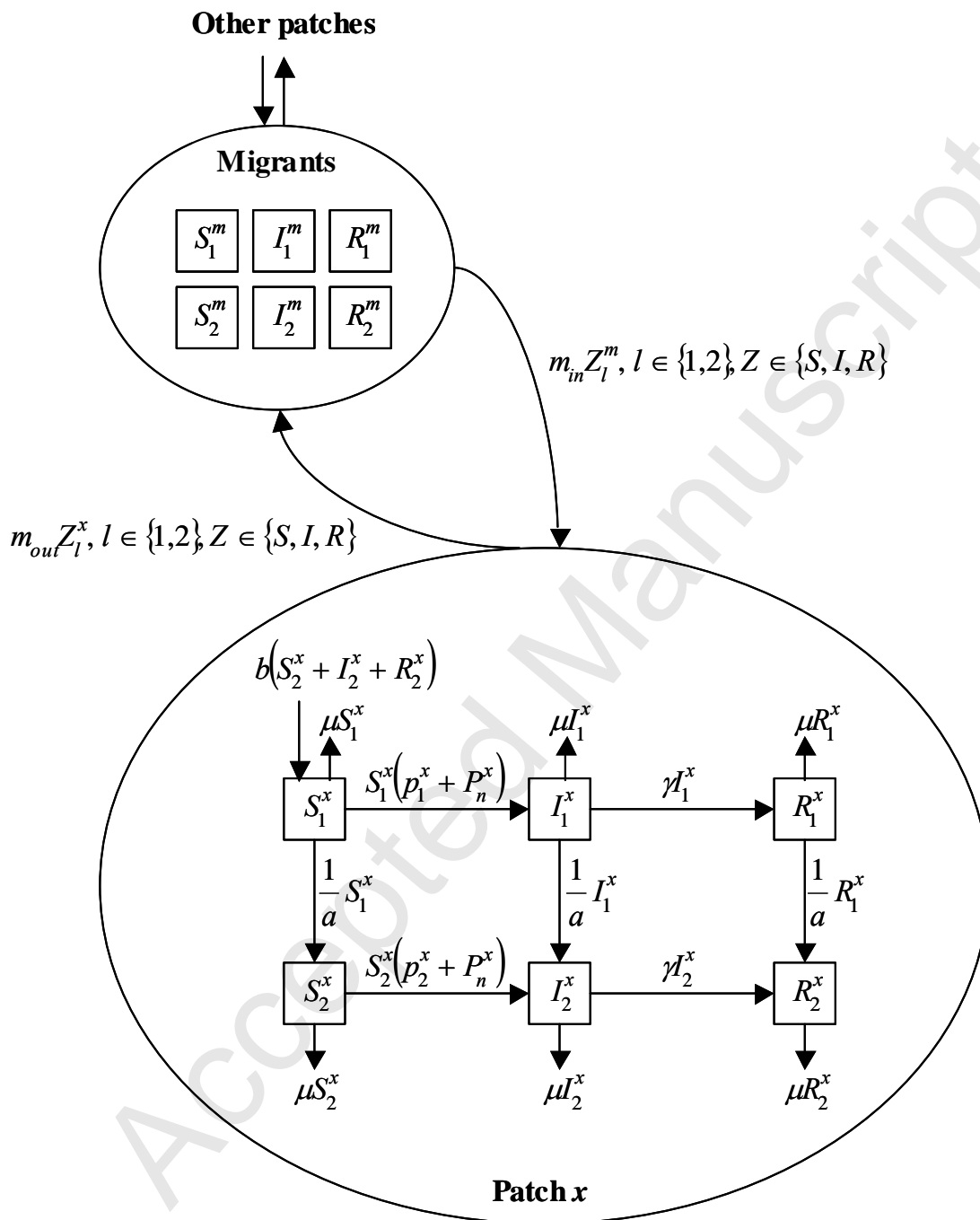

582

583

584 Figure 1

585

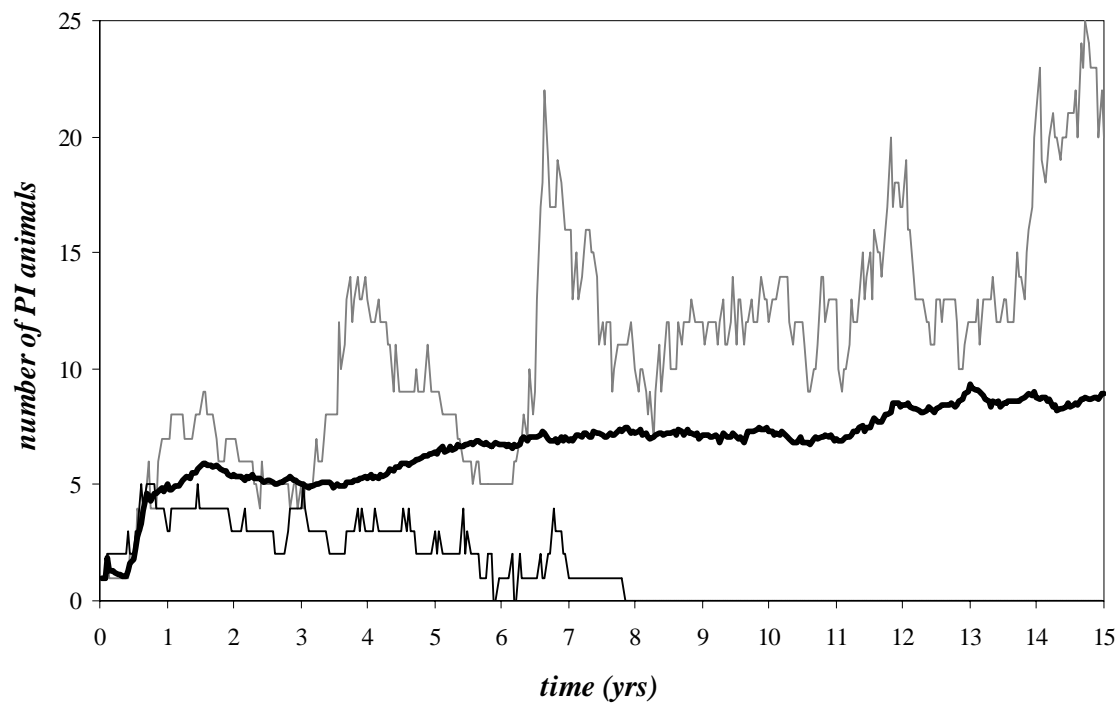

585

586 Figure 2

587

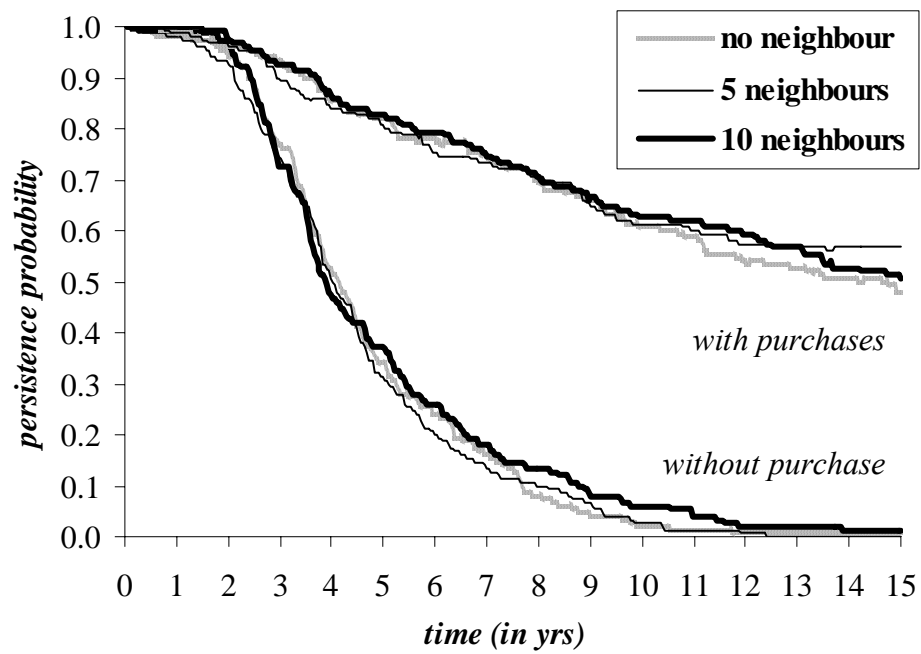

587

588 Figure 3

589

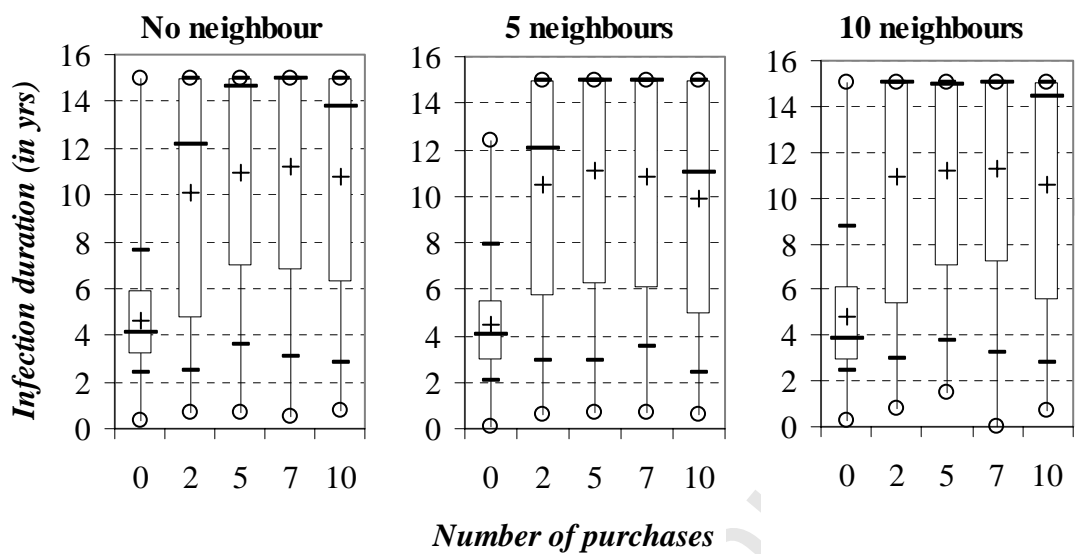

589

(a)

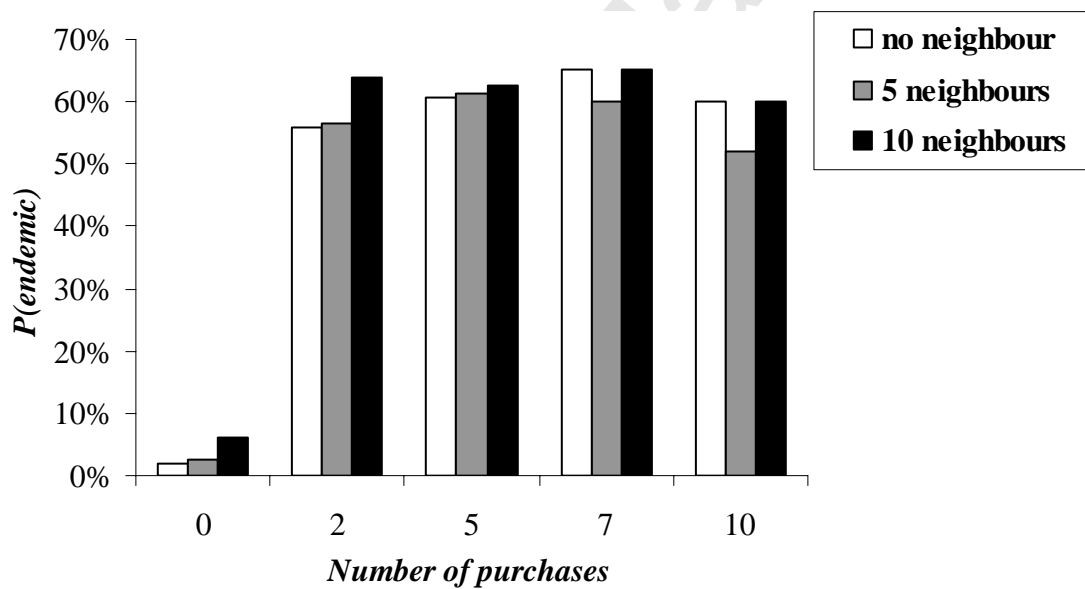

590

(b)

591 Figure 4

592

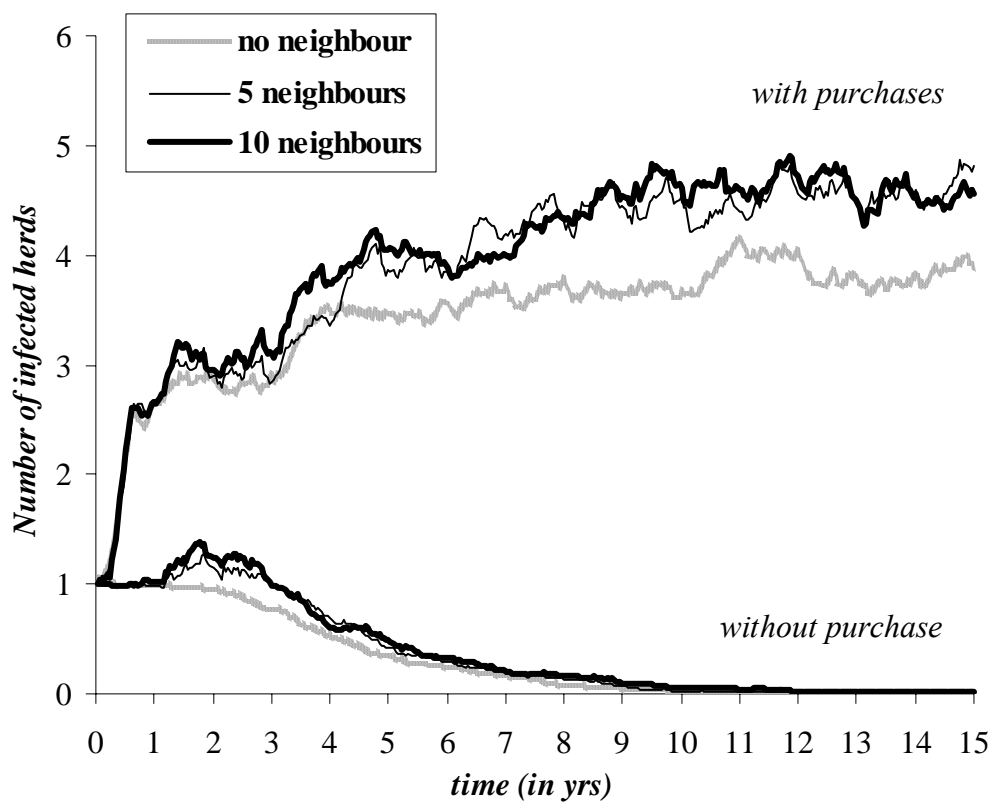

592

593

594

Figure 5

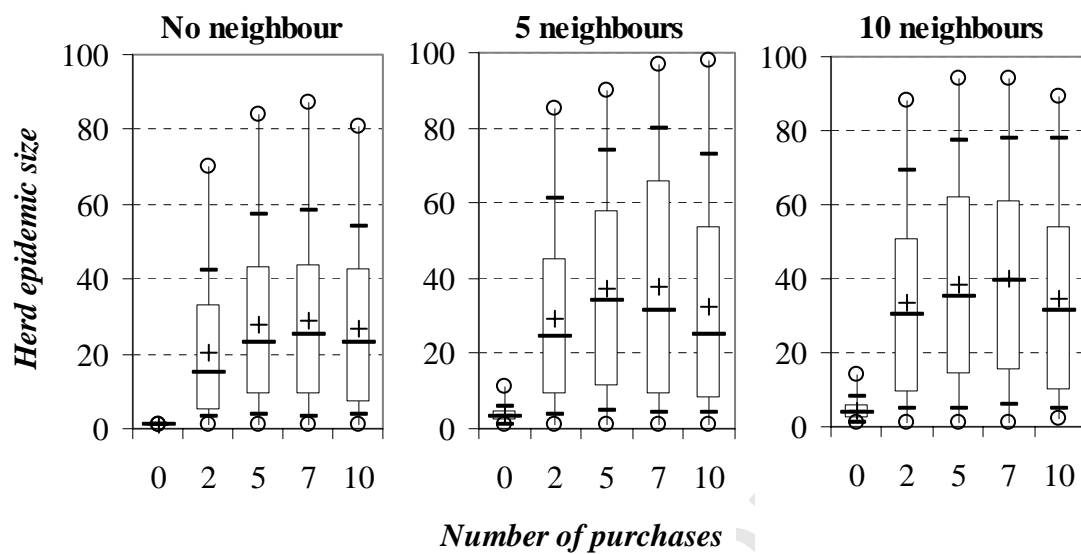

594

595 Figure 6