



**HAL**  
open science

# Analysis of the tensile behaviour of viscoelastically prestressed polymeric matrix composites

Jody W.C. Pang, Kevin S. Fancey

► **To cite this version:**

Jody W.C. Pang, Kevin S. Fancey. Analysis of the tensile behaviour of viscoelastically prestressed polymeric matrix composites. *Composites Science and Technology*, 2009, 68 (7-8), pp.1903. 10.1016/j.compscitech.2007.12.018 . hal-00575240

**HAL Id: hal-00575240**

**<https://hal.science/hal-00575240>**

Submitted on 10 Mar 2011

**HAL** is a multi-disciplinary open access archive for the deposit and dissemination of scientific research documents, whether they are published or not. The documents may come from teaching and research institutions in France or abroad, or from public or private research centers.

L'archive ouverte pluridisciplinaire **HAL**, est destinée au dépôt et à la diffusion de documents scientifiques de niveau recherche, publiés ou non, émanant des établissements d'enseignement et de recherche français ou étrangers, des laboratoires publics ou privés.

## Accepted Manuscript

Analysis of the tensile behaviour of viscoelastically prestressed polymeric matrix composites

Jody W.C. Pang, Kevin S. Fancey

PII: S0266-3538(08)00002-X  
DOI: [10.1016/j.compscitech.2007.12.018](https://doi.org/10.1016/j.compscitech.2007.12.018)  
Reference: CSTE 3937

To appear in: *Composites Science and Technology*

Received Date: 1 October 2007  
Revised Date: 14 December 2007  
Accepted Date: 22 December 2007

Please cite this article as: Pang, J.W.C., Fancey, K.S., Analysis of the tensile behaviour of viscoelastically prestressed polymeric matrix composites, *Composites Science and Technology*(2008), doi: [10.1016/j.compscitech.2007.12.018](https://doi.org/10.1016/j.compscitech.2007.12.018)

This is a PDF file of an unedited manuscript that has been accepted for publication. As a service to our customers we are providing this early version of the manuscript. The manuscript will undergo copyediting, typesetting, and review of the resulting proof before it is published in its final form. Please note that during the production process errors may be discovered which could affect the content, and all legal disclaimers that apply to the journal pertain.



## Analysis of the tensile behaviour of viscoelastically prestressed polymeric matrix composites

Jody W.C. Pang, Kevin S. Fancey\*

Department of Engineering, University of Hull, HU6 7RX, UK

### Abstract

A novel composite material is reported, in which tension, applied to polymeric fibres, is released prior to moulding them into a matrix. Following matrix solidification, compressive stresses imparted by the viscoelastically strained fibres impede crack propagation. Previous Charpy impact studies had demonstrated that these viscoelastically prestressed composites could absorb typically 25-30% more energy than control (unstressed) counterparts and the current study focuses on their tensile behaviour as a function of fibre volume fraction,  $V_f$ . Tensile testing was performed on continuous unidirectional nylon 6,6 fibre – epoxy resin samples. Compared with control counterparts, the results showed that viscoelastic prestressing improved tensile properties, the effects being  $V_f$  - dependent. Increases in tensile strength, modulus and energy absorbed (to 0.25 strain) exceeded 15%, 30% and 40% respectively at an optimum  $V_f$ , this being ~35-40%. Strain-to-failure was reduced by 10-20%, thereby lowering any improvement in tensile toughness (energy absorbed to fracture) to <10%. Mechanical properties of the fibres themselves were not significantly influenced by the treatment used for generating composite prestress, and we propose that the observed improvements to tensile properties may be attributed to: (i) direct contribution from compressive stress, (ii) attenuation of the dynamic overstress effect on fibre fracture and

---

\* Corresponding author. Tel.: +44 1482 465071; fax: +44 1482 466664.  
E-mail address: k.s.fancey@hull.ac.uk

(iii) improved mechanical integrity through a more collective response from fibres to tensile loads.

*Keywords:* A. Polymer-matrix composites (PMCs); B. Mechanical properties; C. Residual stress; Viscoelasticity.

ACCEPTED MANUSCRIPT

## 1. Introduction

In contrast with the concept of prestressed concrete structures, the principle of exploiting purposely induced (compressive) prestress in polymeric matrix composites (PMCs) is relatively recent. Conventionally, prestressed PMCs (PPMCs) can be produced by applying and maintaining tension on glass fibres as the surrounding resin matrix cures. For beam-shaped geometries, this elastic prestressing method has been found to increase impact resistance by up to 33%, when compared with unstressed (control) counterparts [1]. A similar increase in flexural stiffness and strength is also reported [2]. Another study [3] indicates that increases of ~25% for tensile strength and ~50% for (tensile) elastic modulus can be achieved. These improvements, using E-glass fibre in epoxy resin, have been attributed to mechanisms involving compressive stresses within the matrix which (i) impede crack propagation and (ii) reduce composite strain resulting from external tensile and bending loads [1-3].

This paper focuses on further investigations into the mechanical properties of a novel form of PPMC. The novelty involves stretching polymeric fibres under a load, for a period of time, to induce creep; the load is subsequently released prior to moulding the fibres into a resin matrix. A significant proportion of the fibre deformation is viscoelastic and, when the matrix solidifies, compressive stresses are imparted by the viscoelastically strained fibres as they attempt recovery against the surrounding (solid) matrix material. This viscoelastically generated compressive prestress improves impact toughness: using nylon 6,6 fibres in a polyester resin matrix, Charpy tests have demonstrated that viscoelastically prestressed samples can absorb typically 25-30% more impact energy than their control (unstressed) counterparts, with some tests showing up to 50% improvement [4-7]. In contrast with (conventional) elastic

prestressing, the viscoelastic prestress technique offers the following benefits. First, the fibre stretching and moulding operations are de-coupled, enabling more flexible fabrication procedures and facilitating the production of complex component geometries. Second, should there be a tendency for the prestress effect to deteriorate due to localised matrix creep effects near the fibre-matrix interface, longer term recovery mechanisms within the polymeric fibres will be expected to counteract this [6].

To demonstrate viability of the viscoelastic prestressing concept, research has focused on nylon 6,6 fibres (a common fibre material with good mechanical properties), as a precursor to research with other fibres. Subjecting nylon 6,6 fibres to a 24 h tensile creep stress of ~350 MPa produces ~12% strain (there are no fibre fractures). Releasing the stress removes the contribution from elastic strain, leaving a residual recovery strain that decreases only very slowly with time, i.e. ~3% (initial), ~2.5% (2 h) and ~2% (100 h) [4-7]. Consequently, there is no significant difference between the diameters of recovering fibres and unstressed (control) fibres [4]. Accelerated ageing (by time-temperature superposition) to an equivalent of 100 years at 20°C, has shown that viscoelastic recovery mechanisms within the fibres remain active, the strain contribution from viscous flow being negligible ( $<10^{-4}$  %) [7]. This is further supported by observing the long-term force generated from viscoelastic recovery, the mechanisms being associated with thermally activated slippage of molecular segments controlling the release rate of stored elastic energy [8]. By subjecting composite samples to accelerated ageing, the influence of these long-term viscoelastic recovery mechanisms on mechanical performance has also been demonstrated, in that the improvement in impact toughness resulting from viscoelastic prestressing is not observed to deteriorate over a 100 year timescale [7].

To date, evaluating the mechanical performance of viscoelastic PPMCs has been limited to the impact testing of composite samples with very low fibre volume fraction ( $V_f$ ). Further to an initial study [9], this paper investigates the tensile properties of these PPMCs over a range of  $V_f$  values, using epoxy resin as matrix material. An investigation is also made to determine whether the tensile properties of the fibres themselves are changed as a result of the stretching treatment. Clearly, if such changes (e.g. work-hardening) are unknown, erroneous inferences could be made with regard to the influence of viscoelastic prestressing effects in composite samples.

## 2. Experimental

### 2.1 Production of samples

Batches of composite samples required two sets of rectangular specimens, one set being viscoelastically prestressed 'test' samples, the other comprising unstressed, but otherwise identical, 'control' samples. Fibre reinforcement consisted of continuous multi-filament nylon 6,6 yarn (Goodfellow Cambridge Ltd) with 140 filaments, 27.5  $\mu\text{m}$  filament diameter. Two identical lengths of as-received yarn (one 'test' the other 'control') were simultaneously annealed at 150°C for 0.5 h to remove previous thermal/stress history [5]. The designated test yarn was then subjected to 349 MPa tensile stress for 24 h, using a bespoke fibre stretching facility, whilst the control yarn was positioned in close proximity for exposure to the same ambient conditions (20-21.5°C, 30-40% RH). Prior to moulding, test and control yarns were each folded and cut into multiple lengths and then combed into flat ribbons.

A bisphenol-A based, low viscosity epoxy resin with good optical transparency (ABL-Stevens Resin & Glass, U.K.) was used with polyoxyalkyleneamine base hardener catalyst. This was a room temperature-curing resin, the gel time being ~15 h at 20°C. Unidirectional continuous fibre - resin samples were prepared using a leaky mould method (Figure 1), based on principles from Ladizesky and Ward [10]. In addition, the mould was designed so that sections could be removed to facilitate the demoulding process. Two identical moulds were used for each batch, to enable simultaneous preparation of test and control samples from the same resin mix. Immediately following mould assembly, weights were positioned on top of the moulds; this enabled excess resin to flow from each (open) mould end to obtain the correct sample thickness (as determined by the spacers in Figure 1). The moulding procedure was completed within 0.5 h of the fibre stretching process. Following demoulding, the resulting test and control composite strip lengths were each cut into two samples.

## 2.2 *Photographic studies*

Scanning electron microscopy (SEM) and optical microscopy (OM) were used to obtain photographic evidence of effects that could adversely influence composite sample characteristics. The principal concern was to ensure that there would be no differences between test and control samples, other than those from prestress effects. SEM was used to investigate possible topographical changes in test yarn fibres following the applied creep stress. Composite sample cross sections (cut from the centre of the moulded strip, between the two samples designated for tensile testing) were studied by OM, for matrix features and fibre spatial distribution.



### 2.3 Fibre tensile tests

A TA Instruments Q800 Dynamic Mechanical Analyser (DMA) with software was used for this purpose. This enabled a single filament, extracted from the nylon yarn, to be tensile tested at a controlled ambient temperature (20°C). The DMA was operated in force-controlled tension mode, the ramp force rate being 0.25 Nmin<sup>-1</sup>. Monofilaments were selected at random; the nominal fibre length was 35 mm and a 15 mm gauge length was used. Tensile tests were performed on sets of filaments at 24, 120, 168 and 1344 h after the stretching process, each set comprising five test and five control filaments. Tensile strength and strain-to-failure (STF) values were measured.

### 2.4 Tensile tests on composite samples

Each moulded batch comprised two test and two control samples, prepared according to CRAG [11]. Sample dimensions were 200 x 10 x 1 mm. To determine the influence of fibre content on composite tensile properties, batches had  $V_f$  values of 16%, 28%, 41% and 53%, and typically, three batches were tested at each  $V_f$  value. All batches were tested at 20-21°C, 430 h after moulding. Testing was performed using a Lloyd LR100K machine (with analysis software) at a loading rate of 5mm/min. Stress/strain curves provided data on tensile strength, STF, modulus, strain-limited toughness and tensile toughness. Here, strain-limited toughness is defined as the energy/unit volume absorbed to a fixed strain (0.25) and is calculated from the area under the stress-strain curve. This is a more relevant performance parameter for deflection-limited design than the tensile toughness, the latter being calculated to total composite tensile failure.

### 3. Results and discussion

#### 3.1 Photographic analysis

Figure 2 shows the topographical characteristics typical of the test and control fibres. The longitudinal features observed in both fibre groups are considered to be from the original fibre manufacturing process. Most importantly, there appears to be no difference in surface features between the test and control groups that could influence fibre-matrix bonding, and this supports earlier findings [4].

Composite cross sections, from 28%  $V_f$  samples, are shown in Figure 3. These sections have characteristics representing all samples, as they show areas with no fibres and also regions of fibre clustering, in common with samples of lower and higher  $V_f$  values respectively. There are no discernible differences between test and control sections, either in terms of matrix features or fibre spatial distribution.

#### 3.2 Fibre tensile tests

Table 1 summarises the results. Fibre clamping problems led to the premature failure of one filament in each of the 168 and 1344 h control groups, thus sample number was reduced to four in these cases. There are slight variations in tensile strength and STF at different age values; also both test and control STF values indicate a possible increase with time. It is well known that moisture can have a plasticising effect on nylon fibres, and local variations in humidity at the time of testing and/or

progressive moisture absorption during storage (in sealed polyethylene bags) may have contributed to these variations.

The overall means from test and control groups in Table 1 are similar for both strength and STF data, suggesting that the effect of the stretching process on fibre tensile properties could be insignificant. A more rigorous approach using hypothesis tests (two-tailed) at each age value has also been performed. These have revealed no difference between the test and control population means (strength and STF) to a significance level of 2%. At 5% significance level, only the tensile strength data at 24 h indicate a possible difference between the test and control population means. Therefore, subjecting test fibres to the stretching treatment does not cause any significant change in the tensile properties (such as work-hardening effects), relative to corresponding control (unstretched) fibres. Moreover, no changes have been observed in the surface features between test and control fibres (Figure 2). Thus it can be inferred that any improvements to the mechanical properties observed from a composite test sample, compared with its control counterpart, must be attributed to compressive prestress effects within the composite rather than changes to the mechanical properties of the fibres themselves.

### 3.3 Composite tensile tests

Figure 4 represents typical stress-strain curves from a batch of test and control composite samples. At this  $V_f$  value (28%), there is clear evidence that the test samples show increased strength and stiffness. Owing to curve shape, stiffness has been represented by a modulus value determined from the linear region, as shown. The modulus provides a measure of stiffness from elastic and (in common with polymeric

materials) viscoelastic contributions to deformation. This is supported by finding that ~90% of the STF determined at the time of testing had subsequently recovered (elastically and viscoelastically) in all samples when measured several months after the tests were performed. Thus only ~10% of the STF can be attributed to plastic deformation.

Tensile strength data as a function of  $V_f$  are shown in Figure 5 and Table 2. Clearly strength values increase with  $V_f$ ; however, although test and control samples are similar for  $V_f$  at 16% and 53%, the prestressed samples have higher strengths at the intermediate  $V_f$  values. As indicated by the curve in Figure 6, there appears to be an optimum value for  $V_f$  (~35%) at which the increase in strength from prestressing is maximised. We suggest that this can be attributed to the competing roles of fibres and matrix, which are determined by their respective cross-sectional areas: too few fibres will result in less compressive stress within the matrix; conversely, too many fibres will reduce the cross-sectional area over which the compressive stress can function.

From Table 2, the increase in strength for the test samples at 28% and 41%  $V_f$  is 30 MPa and 49 MPa respectively, and it can be inferred from this information and the curve in Figure 6 that the maximum increase in tensile strength could be ~50 MPa. Improved strength may simply be attributed to the need for a tensile load to overcome compressive forces within the matrix, thereby impeding tensile failure mechanisms, such as matrix cracking and fibre fracture. From viscoelastic force measurement studies [8] however, we estimate that the axial stress exerted by the fibres on the matrix would not exceed ~10 MPa at the age the samples were tested (430 h). Thus the observed increases in strength are substantially greater than any compressive stress imparted to the matrix that would have to be overcome during tensile testing. Clearly, there must be contributions to composite strength in addition to the direct effects of matrix

compression. From Sections 3.1 and 3.2, it would be difficult to attribute the additional strength increase to changes in tensile properties or surface topography of the nylon fibres, and it is interesting to note that the effect can also be observed in data [3] from elastic prestressing using glass fibres. For values of composite prestress up to 50 MPa, samples in Ref. [3] with 35-45%  $V_f$  can be seen to exhibit increases in tensile strength (relative to equivalent samples with zero prestress) that are substantially greater than the applied prestress. This suggests that the phenomenon is not limited to a particular fibre-matrix system or method of prestressing.

For brevity, we will define the contribution from direct effects of matrix compression as mechanism (i). We suggest that additional contributions to composite strength may arise from two further mechanisms, i.e. (ii) and (iii). Mechanism (ii) relates to the phenomenon described by Manders and Chou [12], which can be summarised as follows. The failure of a fibre within a composite of aligned fibres causes a stress wave to propagate outwards, and this subjects neighbouring fibres to a dynamic (oscillatory) overstress. The dynamic contribution decays with time to a static stress concentration. Since the overstress generally exceeds the static effect, the probability of adjacent fibres also failing is increased, thereby weakening the composite. For mechanism (ii), we propose that the stress fields created by viscoelastically strained fibres (that impart compression to the matrix) may attenuate the stress wave effect, thereby reducing the probability of collective fibre failure. Thus in addition to mechanism (i), there could be a contribution from mechanism (ii) to the observed increases in tensile strength.

Mechanism (iii) relates to an effect proposed by Motahhari and Cameron [2], in that fibres in a prestressed composite can contribute much more effectively to load support. This arises from the ability of taut and straightened fibres to respond

instantaneously and more collectively to an applied load. Therefore, as the load increases, variations in the levels to which individual fibres are deformed will be reduced, so that subsequent fibre fractures should proceed less progressively. This, relative to a composite with no prestress, will provide higher strength and less sample displacement during the fibre fracture process. The mechanism was proposed for elastically prestressed composites subjected to flexural loads in Ref. [2], and, although a viscoelastically prestressed composite may exhibit some waviness in fibre lay, the fibres are taut and would therefore respond quickly and more collectively to tensile loads, improving mechanical integrity. It should be noted that no significant deviations in fibre alignment (along sample length) could be observed in our composite batches. Thus mechanism (iii) could apply to the current situation and therefore contribute to increased tensile strength.

The modulus, toughness and STF data in Figures 6 – 8 and Tables 2 and 3 may also be explained through the mechanisms discussed above. The trend in the modulus data of Figures 6 and 7 has similarities with the strength data, the increase from prestressed samples exceeding 30% at 41%  $V_f$ . Although mechanism (i) must have a significant role, some contribution from mechanism (iii) would also be expected, since improved mechanical integrity (through a more collective response from fibres to tensile loads) will increase composite resistance to deformation.

The strain-limited toughness data in Figures 6 and 8 show similar characteristics to the modulus results, and the increase exceeds 40% at 28% and 41%  $V_f$ . This is not surprising, since the toughness, defined here to a fixed strain (0.25), will return a large value from a steep stress-strain curve. Therefore, the explanation for increased toughness can, as with the modulus data, be related to mechanisms (i) and (iii); i.e. more work is required from tensile loads to counteract increased composite resistance to

deformation, which arises from compressive stress and the more collective response of fibres.

The STF values for test samples are consistently lower than the control counterparts in Table 2 by 10-20%. This may be attributed to the less progressive extension and fracture of fibres in the test samples, i.e. mechanism (iii). In contrast with the strain-limited toughness data, tensile toughness (to failure) will be sensitive to STF values. Table 3 indicates that tensile toughness is actually reduced in the test samples at 16% and 53%  $V_f$ . At these  $V_f$  values, viscoelastically induced prestressing provides no increase in strength, hence lower STF values will reduce the area under the stress-strain curve, resulting in lower tensile toughness. The effect of reduced STF also limits the increase in tensile toughness at the intermediate  $V_f$  values, these being 8% (28%  $V_f$ ) and 2% (41%  $V_f$ ) from data in Table 3.

#### 4. Conclusions

By performing tensile tests on viscoelastically prestressed composites and individual nylon 6,6 fibres, we have found (relative to control counterparts) the following:

1. Mechanical properties of the fibres themselves, and their topographical characteristics, are not significantly influenced by the stretching treatment used for generating prestress in the composite material.
2. Viscoelastically induced prestressing increases tensile strength, modulus and toughness, the effects being  $V_f$  - dependent. The optimum  $V_f$  value for maximum increase in these properties was indicated to be ~35-40%.

3. Maximum increases in tensile strength, modulus and strain-limited toughness, resulting from prestressing, were found to exceed 15%, 30% and 40% respectively.
4. The strain-to-failure for prestressed samples was reduced by 10-20%, thereby lowering any improvement in tensile toughness (energy absorbed to fracture) to <10%.

We suggest that the  $V_f$  dependency leading to an optimum value can be attributed to the competing roles of the fibres (that generate the compressive stress) and the matrix (over which the compressive stress can function). The increase in tensile strength is substantially higher than the value that would be expected from the direct action of compressive stress alone, and additional indirect contributions resulting from prestress are proposed; these involve attenuation of the dynamic overstress effect on fibre fracture and improved mechanical integrity (through a more collective response from fibres to tensile loads). Such mechanisms may also be used to explain changes observed in the other tensile properties.

This work demonstrates that viscoelastically prestressed composites can, in addition to increased impact toughness, provide the opportunity for improved tensile properties, without the need to increase mass or section dimensions.

### **Acknowledgements**

The authors would like to thank The Leverhulme Trust for financial support (Grant Ref. F/00181/K). Special thanks to Professor Ken Swift and Dr Daxue Sun for



useful discussions, Dr Mike Fagan for facilitating the DMA work, and to Mrs Sue Taft and Mr Garry Robinson for their technical support.

ACCEPTED MANUSCRIPT

**References**

- [1] Motahari S, Cameron J. Impact strength of fibre pre-stressed composites. *J Reinf Plast Comp* 1998; 17(2):123-130.
- [2] Motahari S, Cameron J. Fibre prestressed composites: improvement of flexural properties through fibre prestressing. *J Reinf Plast Comp* 1999; 18(3):279-288.
- [3] Hadi AS, Ashton JN. On the influence of pre-stress on the mechanical properties of a unidirectional GRE composite. *Comp Struct* 1998; 40(3-4):305-311.
- [4] Fancey KS. Investigation into the feasibility of viscoelastically generated pre-stress in polymeric matrix composites. *Mater Sci Eng A* 2000; 279:36-41.
- [5] Fancey KS. Prestressed polymeric composites produced by viscoelastically strained nylon 6,6 fibre reinforcement. *J Reinf Plast Comp* 2000; 29(15):1251-1266.
- [6] Fancey KS. Fibre-reinforced polymeric composites with viscoelastically induced prestress. *J Adv Mater* 2005; 37(2):21-29.
- [7] Pang JWC, Fancey KS. An investigation into the long-term viscoelastic recovery of Nylon 6,6 fibres through accelerated ageing. *Mater Sci Eng A* 2006; 431:100-105.
- [8] Pang JWC, Lamin BM, Fancey KS. Force measurement from viscoelastically recovering Nylon 6,6 fibres. *Mater Lett* 2007; doi: 10.1016/j.matlet.2007.09.061.
- [9] Pang JWC, Fancey KS. An evaluation of viscoelastically prestressed polymeric matrix composite materials. 28<sup>th</sup> SAMPE Europe International Conference, Paris, France, 2-4 April 2007, p. 664-669.
- [10] Ladizesky NH, Ward IM. Ultra-high-modulus polyethylene fibre composites: I-The preparation and properties of conventional epoxy resin composites. *Comp Sci Tech* 1986; 26:129-164.
- [11] Curtis PT, editor. CRAG test methods for the measurement of engineering properties of fibre reinforced plastics. Royal Aerospace Establishment Technical Report TR88012, UK, 1988, Part 3, p.21.
- [12] Manders PW, Chou TW. Enhancement of strength in composites reinforced with previously stressed fibres. *J Comp Mat* 1983; 17:26-44.

**Figure captions**

Fig. 1. Schematic of the leaky mould principles for sample preparation with dimensions (in mm) used for this work.

Fig. 2. SEM micrographs of test and control nylon 6,6 fibres, subjected to the annealing and creep conditions used for composite sample preparation. Both fibre groups were annealed simultaneously; micrographs were taken 385 h after stretching the test fibres.

Fig. 3. Optical micrograph (polished) sections of test and control composite samples at 28%  $V_f$ .

Fig. 4. Tensile stress-strain plots for a batch of test (prestressed) and control samples showing typical curve shape; samples with 28%  $V_f$ . Strain-limited toughness is determined from the shaded area under each curve.

Fig. 5. Influence of fibre volume fraction on tensile strength of test samples compared with control counterparts. Error bars indicate standard error of the mean.

Fig. 6. Dependence of tensile properties of test samples relative to control counterparts, as a function of fibre volume fraction.

Fig. 7. Influence of fibre volume fraction on tensile modulus of test samples compared with control counterparts. Error bars indicate standard error of the mean.

Fig. 8. Influence of fibre volume fraction on strain-limited toughness of test samples compared with control counterparts.. Error bars indicate standard error of the mean.

Table 1

Summary of Nylon 6,6 single filament results; S.E is the standard error of the mean.

Age (h)	Mean Tensile Strength (TS) and Strain-to-failure (STF)			
	Test		Control	
	TS $\pm$ S.E (MPa)	STF $\pm$ S.E (%)	TS $\pm$ S.E (MPa)	STF $\pm$ S.E (%)
<b>24</b>	924 $\pm$ 25	28.8 $\pm$ 2.0	1008 $\pm$ 24	29.4 $\pm$ 1.8
<b>120</b>	968 $\pm$ 44	26.8 $\pm$ 0.5	910 $\pm$ 46	29.2 $\pm$ 2.4
<b>168</b>	1071 $\pm$ 43	32.5 $\pm$ 1.0	1056 $\pm$ 42*	38.9 $\pm$ 2.8
<b>1344</b>	956 $\pm$ 37	39.4 $\pm$ 3.5	926 $\pm$ 31*	35.9 $\pm$ 2.2
<b>Mean</b>	980 $\pm$ 37	31.9 $\pm$ 1.8	975 $\pm$ 35	33.4 $\pm$ 2.3

\* Sample number reduced to four due to premature failure of one filament from clamping arrangement.

Table 2

Summary of strength, strain-to-failure and modulus data from tensile tests on

composite samples; S.E is the standard error of the mean.

$V_f$ (%)	Tensile strength ± S.E (MPa)		Strain-to-failure ± S.E (%)		Modulus ± S.E (MPa)	
	Test	Control	Test	Control	Test	Control
	<b>16</b>	130 ± 3	130 ± 2	28.9 ± 0.7	36.0 ± 1.0	642 ± 20
<b>28</b>	252 ± 7	222 ± 10	29.5 ± 0.8	32.6 ± 0.8	1441 ± 53	1180 ± 115
<b>41</b>	379 ± 6	330 ± 5	27.4 ± 0.8	31.5 ± 0.2	2145 ± 36	1637 ± 32
<b>53</b>	417 ± 12	418 ± 16	27.3 ± 0.4	32.8 ± 2.8	2519 ± 44	2073 ± 42

Table 3

Mean energy absorbed to 25% strain (strain-limited toughness) and energy absorbed to fracture (tensile toughness) from tensile tests on composite samples; S.E is the standard error of the mean.

$V_f$ (%)	Energy absorbed to 25% strain $\pm$ S.E (kJm <sup>-3</sup> )		Energy absorbed to fracture $\pm$ S.E (kJm <sup>-3</sup> )	
	Test	Control	Test	Control
16	16590 $\pm$ 209	13374 $\pm$ 190	21595 $\pm$ 897	26677 $\pm$ 1414
28	27223 $\pm$ 747	19360 $\pm$ 373	39076 $\pm$ 886	36182 $\pm$ 2467
41	40129 $\pm$ 149	28183 $\pm$ 651	48395 $\pm$ 2390	47385 $\pm$ 416
53	42556 $\pm$ 352	32085 $\pm$ 981	57014 $\pm$ 905	63931 $\pm$ 1550

Figure 1

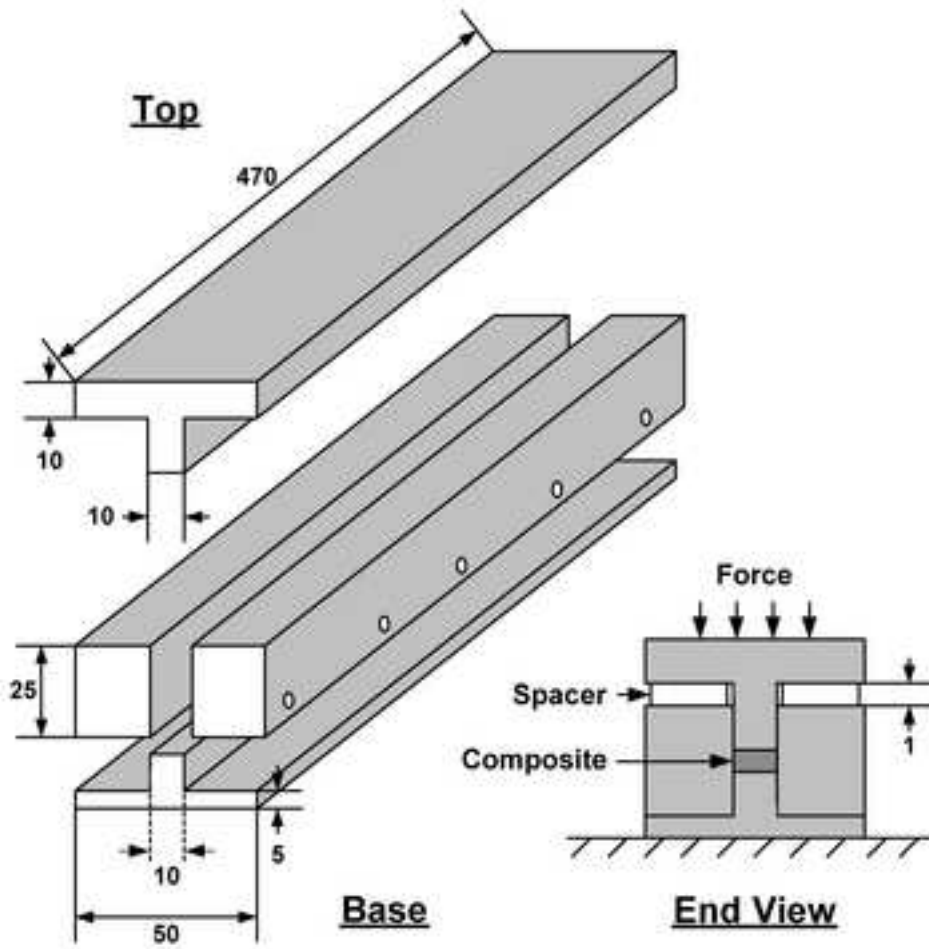

Figure 2

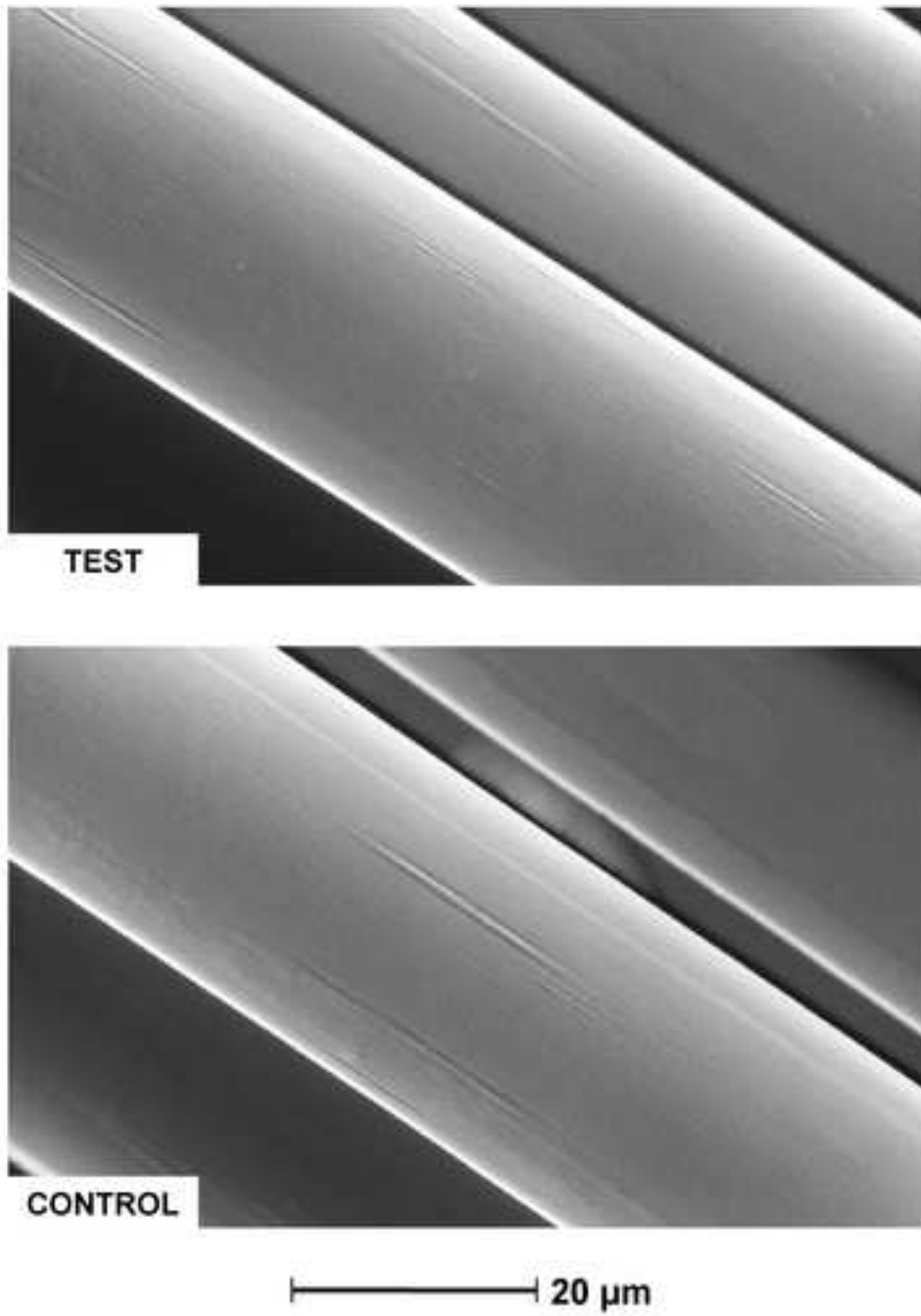



Figure 3

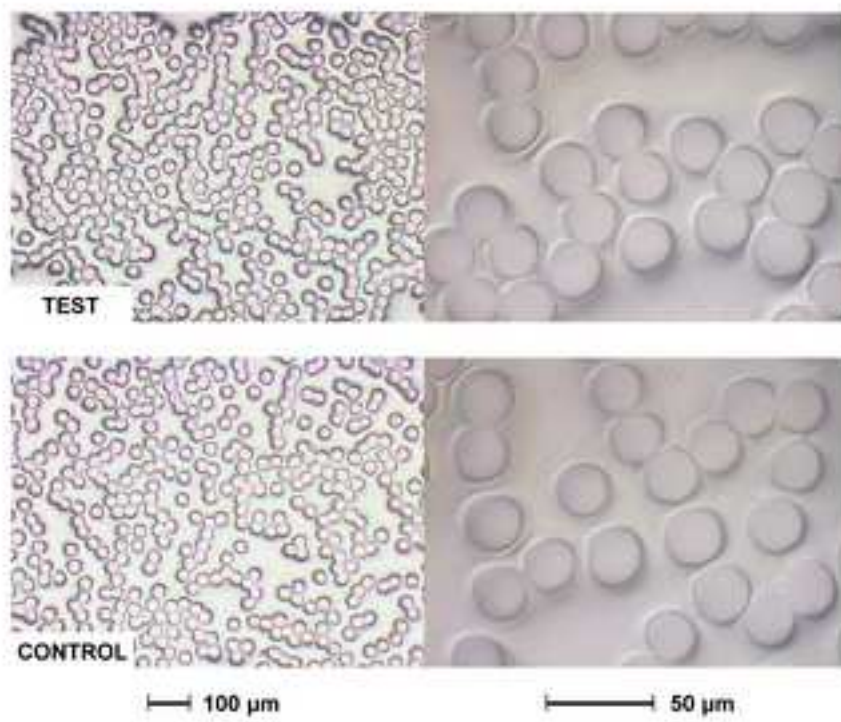

Figure 4

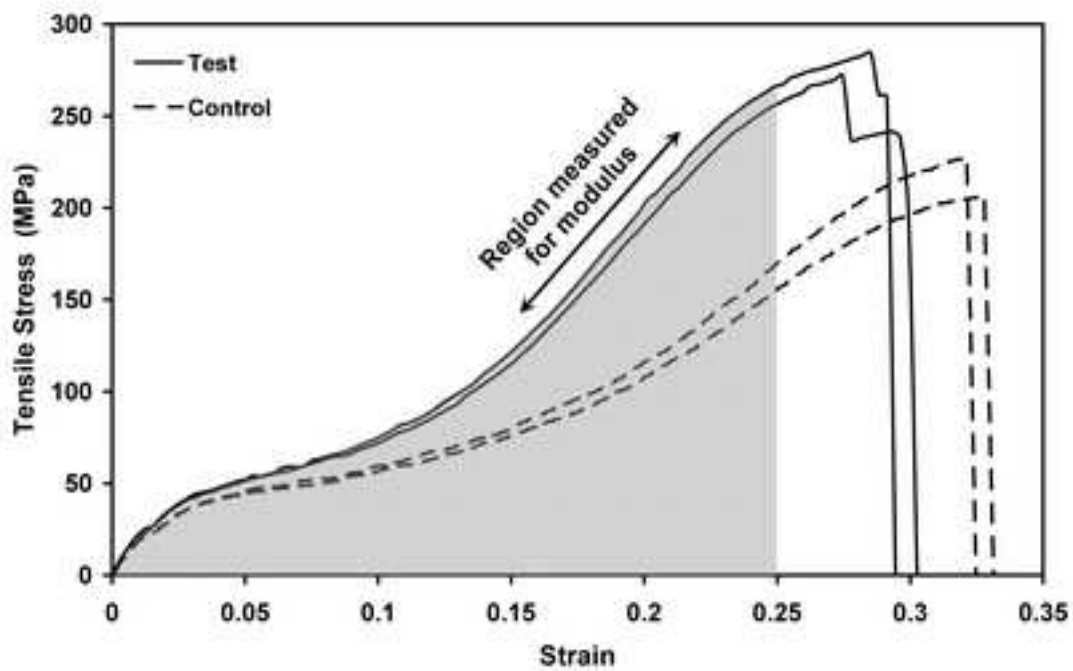

Figure 5

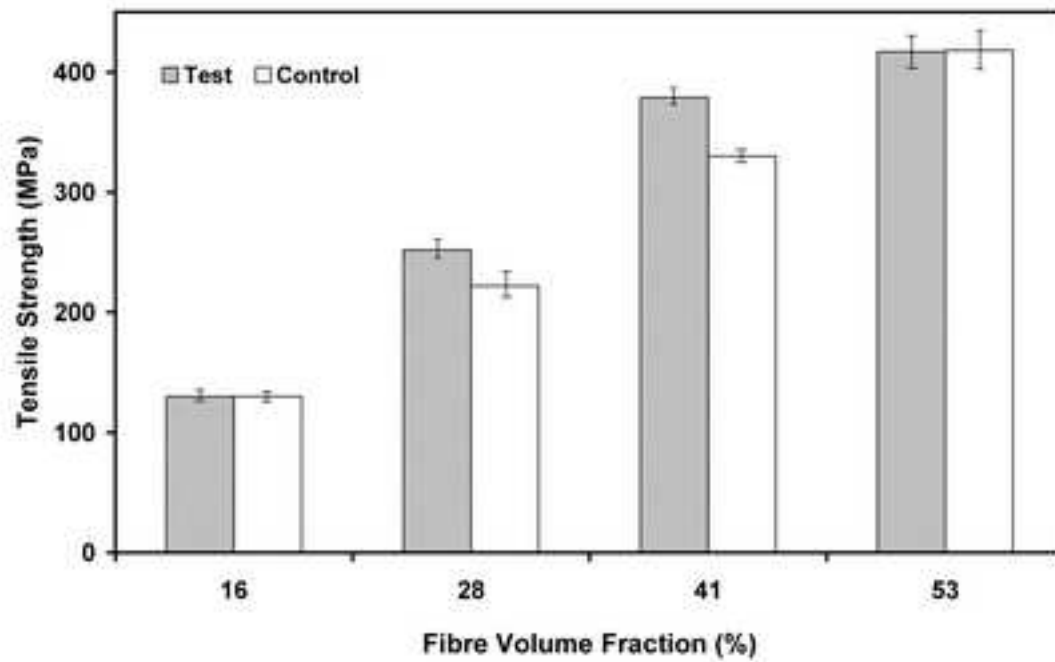

Figure 6

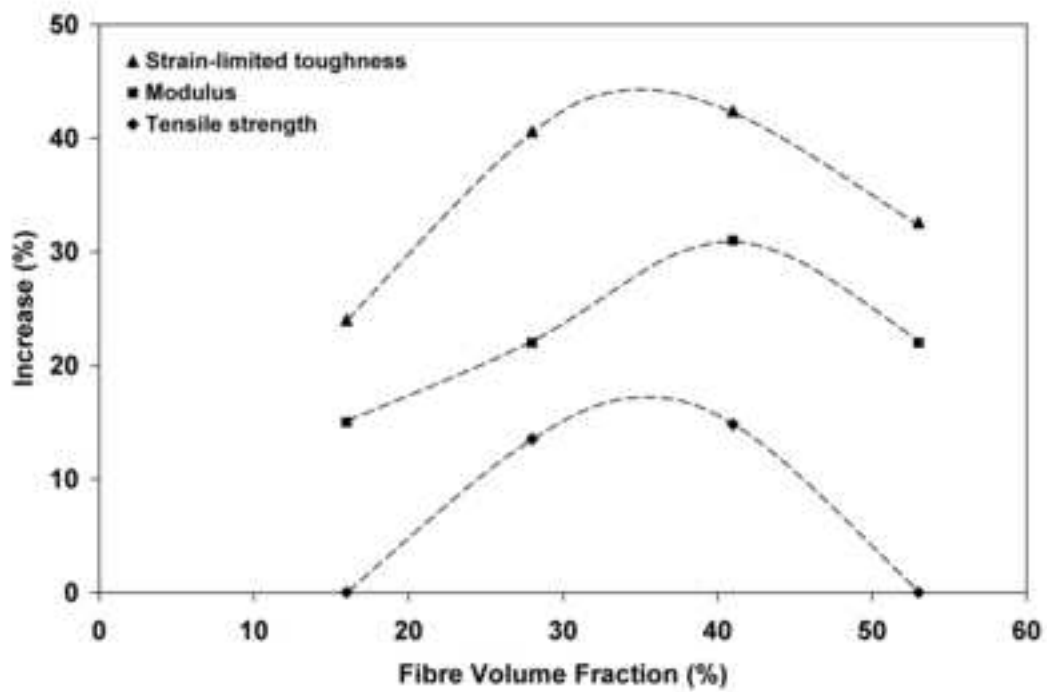

Figure 7

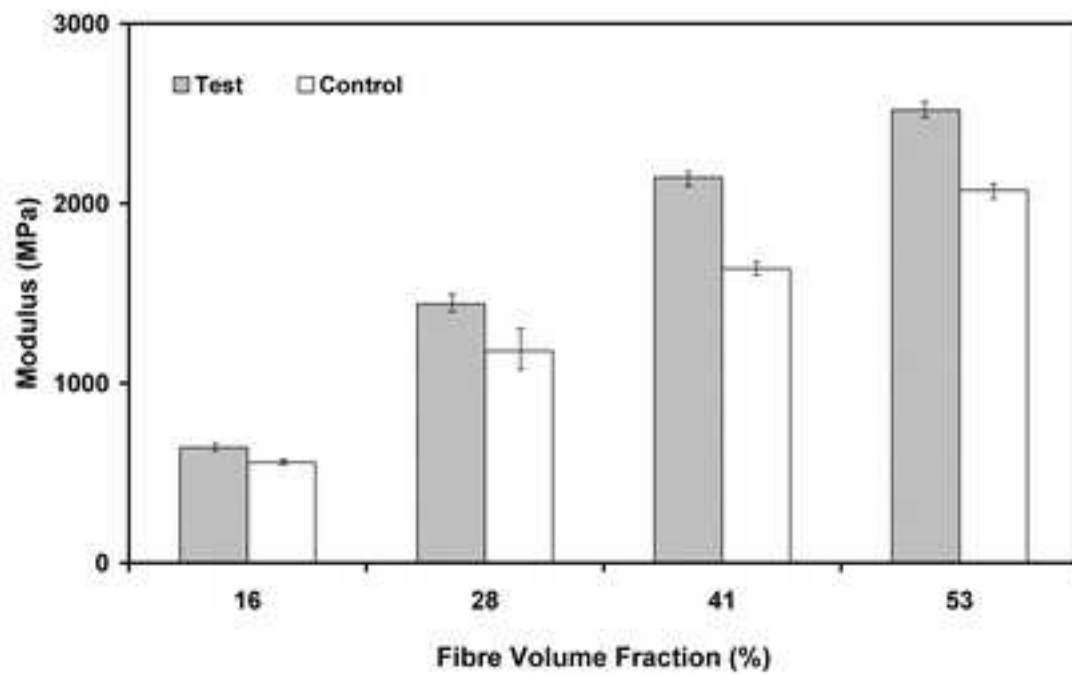

Figure 8

