



HAL
open science

Zonal shear and super-rotation in a magnetized spherical Couette-flow experiment

Daniel Brito, Thierry Alboussiere, Philippe Cardin, Nadège Gagnière, Dominique Jault, Patrick La Rizza, Jean-Paul Masson, Henri-Claude Nataf, Denys Schmitt

► **To cite this version:**

Daniel Brito, Thierry Alboussiere, Philippe Cardin, Nadège Gagnière, Dominique Jault, et al.. Zonal shear and super-rotation in a magnetized spherical Couette-flow experiment. *Physical Review E : Statistical, Nonlinear, and Soft Matter Physics*, 2011, 83 (6), pp.066310. 10.1103/PhysRevE.83.066310 . hal-00569377v2

HAL Id: hal-00569377

<https://hal.science/hal-00569377v2>

Submitted on 16 May 2011

HAL is a multi-disciplinary open access archive for the deposit and dissemination of scientific research documents, whether they are published or not. The documents may come from teaching and research institutions in France or abroad, or from public or private research centers.

L'archive ouverte pluridisciplinaire **HAL**, est destinée au dépôt et à la diffusion de documents scientifiques de niveau recherche, publiés ou non, émanant des établissements d'enseignement et de recherche français ou étrangers, des laboratoires publics ou privés.

1 **Zonal shear and super-rotation in a magnetized spherical Couette**
2 **flow experiment**

3 D. Brito

4 *Laboratoire des Fluides Complexes et leurs Réservoirs,*
5 *Université de Pau et des Pays de l'Adour,*
6 *CNRS, BP 1155, 64013 Pau Cedex France**

7 T. Alboussière,[†] P. Cardin, N. Gagnière, D. Jault, P.

8 La Rizza, J.-P. Masson, H.-C. Nataf, and D. Schmitt

9 *Institut des Sciences de la Terre, CNRS,*
10 *Observatoire de Grenoble, Université Joseph-Fourier,*
11 *Maison des Géosciences, BP 53, 38041 Grenoble Cedex 9, France*

12 (Dated: May 23, 2011)

Abstract

We present measurements performed in a spherical shell filled with liquid sodium, where a 74 mm-radius inner sphere is rotated while a 210 mm-radius outer sphere is at rest. The inner sphere holds a dipolar magnetic field and acts as a magnetic propeller when rotated. In this experimental set-up called *DTS*, direct measurements of the velocity are performed by ultrasonic Doppler velocimetry. Differences in electric potential and the induced magnetic field are also measured to characterize the magnetohydrodynamic flow. Rotation frequencies of the inner sphere are varied between -30 Hz and +30 Hz, the magnetic Reynolds number based on measured sodium velocities and on the shell radius reaching to about 33. We have investigated the mean axisymmetric part of the flow, which consists of differential rotation. Strong super-rotation of the fluid with respect to the rotating inner sphere is directly measured. It is found that the organization of the mean flow does not change much throughout the entire range of parameters covered by our experiment. The direct measurements of zonal velocity give a nice illustration of Ferraro's law of isorotation in the vicinity of the inner sphere where magnetic forces dominate inertial ones. The transition from a Ferraro regime in the interior to a geostrophic regime, where inertial forces predominate, in the outer regions has been well documented. It takes place where the local Elsasser number is about 1. A quantitative agreement with non-linear numerical simulations is obtained when keeping the same Elsasser number. The experiments also reveal a region that violates Ferraro's law just above the inner sphere.

* formerly member of the geodynamo team (Institut des Sciences de la Terre); daniel.brito@univ-pau.fr

† now at : Laboratoire de Sciences de la Terre, Universit de Lyon, ENS de Lyon, CNRS, Lyon, France

13 I. INTRODUCTION

14 The Earth's fluid core below the solid mantle consists of a 3480 km-radius spherical cavity
15 filled with a liquid iron alloy. A 1220 km-radius solid inner core sits in its center. It has
16 been accepted since the 1940's [1, 2] that the flows stirring the electrically conducting liquid
17 iron in the outer core produce the Earth's magnetic field by dynamo action. The fluid
18 motion is thought to originate from the cooling of the Earth's core, which results both in
19 crystallization of the inner core and in convection in the liquid outer core [3].

20 The last decade has seen enormous progress in the numerical computation of the geo-
21 dynamo problem after the first simulation of a dynamo powered by convection [4–7]. It
22 is however still unclear why many characteristics of the Earth's magnetic field are so-well
23 retrieved with simulations [8] since the latter are performed with values of important di-
24 mensionless parameters that differ much from the appropriate values for the Earth's core.
25 The main numerical difficulty is the simultaneous computation of the velocity, the magnetic
26 and the temperature fields with realistic diffusivities, respectively the fluid viscosity, the
27 magnetic and the thermal diffusivities. Those differ indeed by six orders of magnitude in
28 the outer core [9]; such a wide range is at present out of reach numerically, the simulations
29 being performed at best with two orders of magnitude difference between the values of the
30 diffusivities. An experimental approach of the geodynamo is, in that respect, promising since
31 the fluid metals used in experiments have physical properties, specifically diffusivities, very
32 close to the properties of the liquid iron alloy in the Earth's outer core. Moreover, experi-
33 ments and simulations are complementary since they span different ranges of dimensionless
34 parameters.

35 Magnetohydrodynamics experiments devoted to the dynamo study have started some 50
36 years ago (see the chapter authored by Cardin and Brito in [10] for a review). To possibly
37 induce magnetic fields, the working fluid must be liquid sodium in such experiments. Sodium
38 is indeed the fluid that best conducts electricity in laboratory conditions. A breakthrough
39 in these dynamo experiments occurred at the end of 1999 when amplification and saturation
40 of an imposed magnetic field were measured for the first time in two experiments, in Riga
41 [11] and in Karlsruhe [12]. The common property of those set-ups was to have the sodium
42 motion very much constrained spatially, in order to closely follow fluid flows well known
43 analytically to lead to a kinematic dynamo, respectively the Ponomarenko flow [13] and the

44 G.O. Roberts flow [14]. More recently, the first experimental dynamo in a fully turbulent
45 flow was obtained in a configuration where two crenelated ferromagnetic rotating discs drive
46 a von Kàrmàn swirling flow in a cylinder [15]. Earth's like magnetic field reversals were
47 also obtained in this experimental dynamo [16]. Other similar experiments have been run
48 where sodium flows are driven by propellers in a spherical geometry [17, 18]. In order to
49 emphasize the specificity of the experimental study presented in the present paper, it is
50 worth mentioning two common features of the previously mentioned sodium experiments:
51 the forcing of the sodium motion is always purely mechanical and the magnetic field is *weak*
52 in the sense that Lorentz forces are small compared to the non-linear velocity terms in the
53 equation of motion [19].

54 The experiment called *DTS* for "Derviche Tourneur Sodium" has been designed to in-
55 vestigate a supposedly relevant regime for the Earth's core, the magnetostrophic regime
56 [20–22] where the ratio of Coriolis to Lorentz forces is of the order one. The container made
57 of weakly conducting stainless steel is spherical and can rotate about a vertical axis. An
58 inner sphere consisting of a copper envelope enclosing permanent magnets is placed at the
59 center of the outer sphere; the force free magnetic field produced by those magnets enables
60 to explore dynamical regimes where Coriolis and Lorentz forces are comparable. The sodium
61 motion in the spherical gap is driven by the differential rotation between the inner sphere
62 and the outer sphere, unlike in the Earth's core where the iron motion is predominantly
63 driven by convection [23] and maybe minorly by differential rotation of the inner core [24].

64 The *DTS* experiment has not been designed to run in a dynamo regime. It has instead
65 been conceived as a small prototype of a possible future large sodium spherical dynamo
66 experiment which would benefit from its results. Note that meanwhile Daniel Lathrop and
67 collaborators have built a 3m-diameter sodium spherical experiment with an inner sphere
68 differentially rotating with respect to the outer sphere, like in *DTS*. Schaeffer, Cardin and
69 Guervilly [25, 26] have shown numerically that a dynamo could occur in a spherical Couette
70 flow at large Rm in a low magnetic Prandtl number fluid such as sodium ($Pm = \nu/\lambda$, see
71 TABLE I).

72 Numerical simulations in a *DTS*-type configuration [27–29] of Couette spherical flows
73 with an imposed magnetic field all show azimuthal flows stabilized by magnetic and rotation
74 forces. Using electric potential measurements along a meridian of the outer sphere boundary,
75 we concluded in our first report of *DTS* experimental results [30] that the amplitude of the

76 azimuthal flow may exceed the velocity of sodium in solid body rotation with the inner
77 sphere, as predicted theoretically in the linear regime [31].

78 The *DTS* experiment offers a tool to investigate non uniform rotation of an electrically
79 conducting fluid in the presence of rotation and magnetic forces. The differential rotation
80 of a body permeated by a strong magnetic field and the waves driven by the non uniform
81 rotation have received considerable attention since the work of Ferraro [32, 33]. Indeed,
82 the absence of solid envelopes makes non uniform rotation possible in stars, where it plays
83 an important role in the mixing of chemical elements [34], in contrast with the case of
84 planetary fluid cores. Ferraro found that the angular rotation in an electrically conducting
85 body permeated by a steady magnetic field symmetric about the axis of rotation tends to
86 be constant along magnetic lines of force. MacGregor and Charbonneau [35] illustrated this
87 result and showed, in a weakly rotating case, that Ferraro’s theorem holds for $\text{Ha} \gg 1$ (Ha ,
88 the Hartmann number, measures the magnetic strength, see TABLE II). An intense magnetic
89 field, probably of primordial origin, is the key actor in the transfer of angular momentum
90 from the solar radiative interior to the convection zone [36, 37]. Finally, in a geophysical
91 context, Aubert recently found, investigating zonal flows in spherical shell dynamos, that
92 Ferraro’s law of isorotation gives a good description of the geometry of the zonal flows of
93 thermal origin [38].

94 In the second study of the *DTS* experiment [39], we investigated azimuthal flows when
95 both the inner boundary and the outer boundary are rotating but at different speeds, using
96 Doppler velocimetry and electric potential measurements. Specifically, we discussed the
97 transition between the outer geostrophic region and the inner region where magnetic forces
98 dominate. Extending the asymptotic model of Kleorin et al. [40], we could explain the
99 shape of the measured azimuthal velocity profiles. We had to use a specific electric potential
100 difference as a proxy of the differential rotation between the two spheres as, unfortunately,
101 the electrical coupling between the liquid sodium and the copper casing of the interior
102 magnets was apparently both imperfect and unreliable. Finally, we reported in on our third
103 article [41] about the *DTS* experiment the presence of azimuthally traveling hydromagnetic
104 waves that we inferred mainly from electric potential measurements along parallels.

105 We investigate here again the main flows when the outer sphere is at rest. Our new study
106 benefits from a comparison with our earlier work [39] for a rotating outer sphere. There is no
107 need any more to use an indirect measure of the global rotation of the fluid as the electrical

108 coupling between liquid sodium and copper has become unimpaired. Furthermore, the *DTS*
109 experiment has been equipped with a host of new measurement tools. The flow amplitude
110 is measured along 7 different beams using Doppler velocimetry. Assuming axisymmetry, we
111 have thus been able to map the azimuthal flow in most of the fluid. It turns out that the
112 electric potential differences evolve monotonically with the inner core rotation but cannot
113 be interpreted directly as a measure of the velocity below the outer viscous boundary layer.
114 We have also entered a probe inside the cavity to measure the induced magnetic field in
115 the interior. The dense measurements in the *DTS* experiment give a nice illustration of
116 the Ferraro law of isorotation [32] in the inner region where magnetic forces dominate. In the
117 outer region, we retrieve axially invariant azimuthal flow as the Proudman-Taylor theorem
118 holds there, even though the outer sphere is at rest. The variation of the geostrophic velocity
119 with the distance to the axis differs nevertheless from the case of a rotating outer sphere as
120 recirculation in the outer Ekman layer plays an important role in the latter case.

121 The organisation of the paper is as follows. In section II, we describe the experimental set-
122 up and the techniques that we use to measure the magnetic, electric and velocity fields; we
123 illustrate them with a discussion of a typical experimental run. In section III, we present the
124 governing equations and the relevant dimensionless numbers of the experiment. We devote
125 one section of the article to the observation of differential rotation and another one to the
126 meridional circulation. Then, the experimental measurements are compared to numerical
127 simulations of *DTS*. We summarize and discuss the results of our study in section VII.

128 **II. THE *DTS* EXPERIMENT**

129 **A. The experimental set-up**

130 The *DTS* experimental set-up [30, 39, 41] is shown in FIG. 1. It has been installed in a
131 small building purpose-designed for sodium experiments.

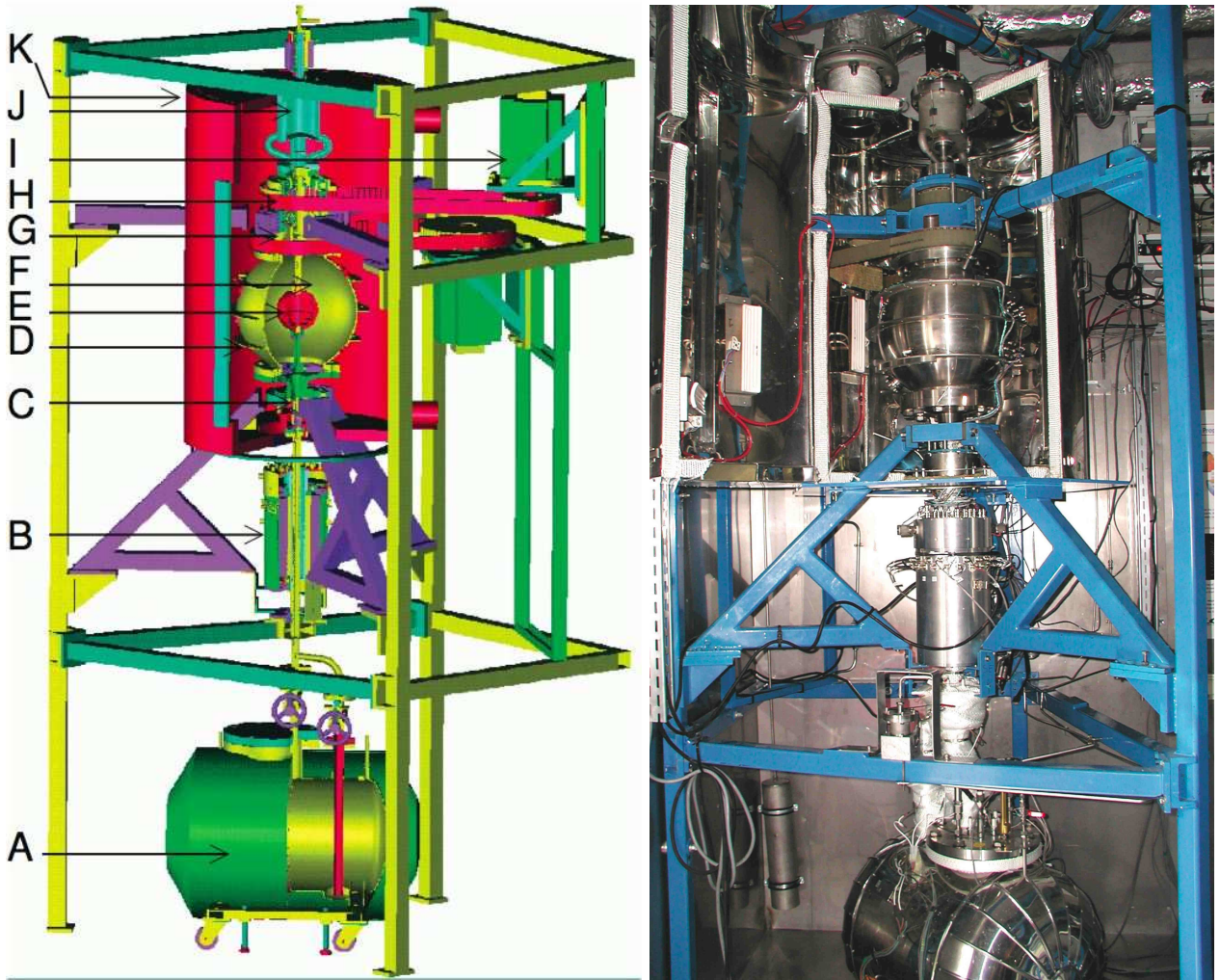

FIG. 1. (Color online) Diagram and picture of the experimental set-up. A: moveable sodium reservoir, B: shielded electric slip-ring, C: electromagnetic valve, D: outer sphere, E: magnetized rotating inner sphere, F: spherical shell containing liquid sodium, G: magnetic coupling entraining the inner sphere shaft, H: crenelated belt, I: brushless electric motor driving the inner sphere, J: expansion tank for sodium, K: thermostated chamber. The total height of the set-up is 3.9 m.

132 As shown in FIG. 1, liquid sodium is contained in a spherical shell between an outer

133 sphere and an inner sphere. The radius of the outer sphere is $a = 210$ mm and that of the
134 inner sphere $b = 74$ mm. The outer sphere is made of stainless steel and is 5 mm thick.
135 The copper inner sphere (FIG. 2 and FIG. 3) contains magnetized Rare-Earth cobalt bricks
136 assembled such that the resulting permanent magnetic field is very close to an axial dipole
137 of moment intensity 700 Am^2 , with its axis of symmetry aligned with the axis of rotation.
138 The magnetic field points upward along the rotation axis and its magnitude ranges from 345
139 mT at the poles of the inner sphere down to 8 mT at the equator of the outer sphere.

140 Sodium is kept most of the time in the reservoir at the bottom of the set-up. When
141 needed to run an experiment, sodium is melted and pushed up from that reservoir into the
142 spherical shell by imposing an overpressure of Argon in the reservoir. When liquid sodium
143 reaches the expansion tank at the top of the spherical shell, an electromagnetic valve located
144 just below the sphere (see FIG. 1) is locked such that sodium is kept in the upper part during
145 experiments. In case of emergency, the valve is opened and sodium pours directly into the
146 reservoir.

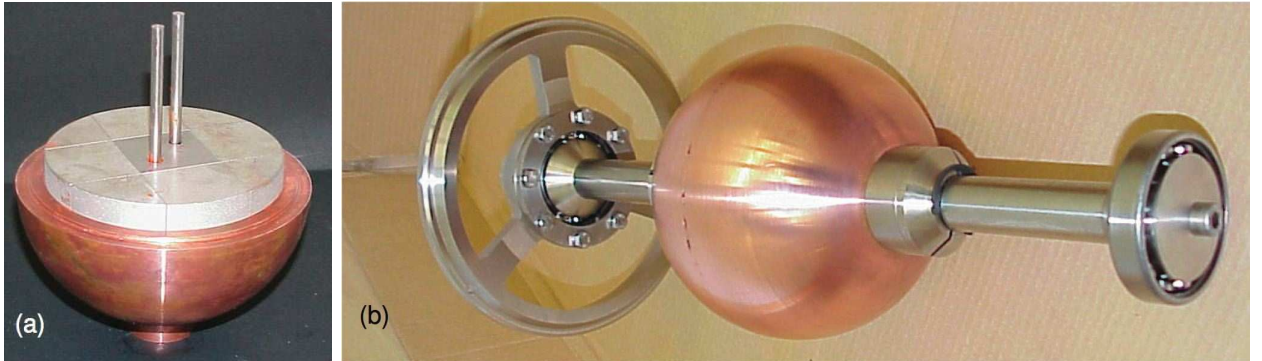

FIG. 2. (Color online) (a) Picture of one hemisphere of the inner sphere. Different pieces of magnets in gray are assembled in the bulk of the inner sphere. (b) View from the side of the inner sphere and its rotating shaft. Note that the wheels at the top and bottom (only one is shown in the picture) of the rotating shaft are attached to the outer sphere.

147 The central part of the experiment is air-conditioned in a chamber maintained at around
148 130°C during experiments: four 1 kW infrared radiants disposed around the outer sphere
149 heat the chamber, whereas cold air pumped from outside cools the set-up when necessary.
150 Liquid sodium is therefore usually kept some 30°C above its melting temperature during
151 experiments. Some physical properties of sodium relevant to our study are listed in TABLE I.

TABLE I. Physical properties of pure liquid sodium at 130°C (Documents from CEA, Commissariat à l’Energie Atomique et aux énergies alternatives). *The sound velocity in sodium has been precisely measured in the present study using the UDV apparatus.

ρ	density	$9.3 \cdot 10^2 \text{ kg m}^{-3}$
σ	electric conductivity	$9 \cdot 10^6 \text{ } \Omega^{-1} \text{ m}^{-1}$
ν	kinematic viscosity	$6.5 \cdot 10^{-7} \text{ m}^2 \text{ s}^{-1}$
η	magnetic diffusivity	$8.7 \cdot 10^{-2} \text{ m}^2 \text{ s}^{-1}$
c	sound velocity*	$2.45 \cdot 10^3 \text{ m s}^{-1}$

152 The whole volume containing sodium, from the reservoir tank up to the expansion tank is
 153 kept under Argon pressure at all times in order to limit oxidization of sodium.

154 The rotation of the inner sphere, between $f = -30 \text{ Hz}$ and $f = 30 \text{ Hz}$, is driven by
 155 a crenelated belt attached to a 11 kW brushless motor (SGMH-1ADCA61 from Yaskawa
 156 Electric Corporation, Tokyo, Japan). The belt entrains a home-made magnetic coupler
 157 located around the inner sphere shaft as seen in FIG. 1. The coupler is composed of an
 158 array of magnets located outside the sodium container, another array of magnets inside the
 159 container being immersed in liquid sodium. The inner magnets are anchored to the rotating
 160 shaft of the inner sphere such that when the belt is rotated outside, the inner sphere is
 161 rotated as well. Such a coupler has the advantage of not requiring any rotating seal in liquid
 162 sodium. Torque values up to about 70 N·m have been efficiently transmitted through this
 163 coupler in the experiment.

164 B. Measurements

165 1. Ultrasonic Doppler velocimetry

166 We use UDV ultrasonic Doppler velocimetry [42] in order to measure liquid sodium ve-
 167 locities in the spherical shell. This non intrusive technique has been intensively used in our
 168 group for the last decade, in particular in rotating experiments performed either in water
 169 or in liquid metals [43–46]. The technique consists in the emission from a piezoelectric
 170 transducer of a succession of bursts of ultrasonic waves that propagate in the fluid. When

171 the wave encounters a particle with a different acoustic impedance, part of the ultrasonic
 172 wave is backscattered towards the transducer. The time elapsed between the emitted and
 173 the reflected waves and the change in that time respectively give the position of the par-
 174 ticle with respect to the transducer and the fluid velocity along the beam direction. Data
 175 processing is internal to the DOP2000 apparatus (<http://www.signal-processing.com>,
 176 Signal Processing company, Lausanne, Switzerland).

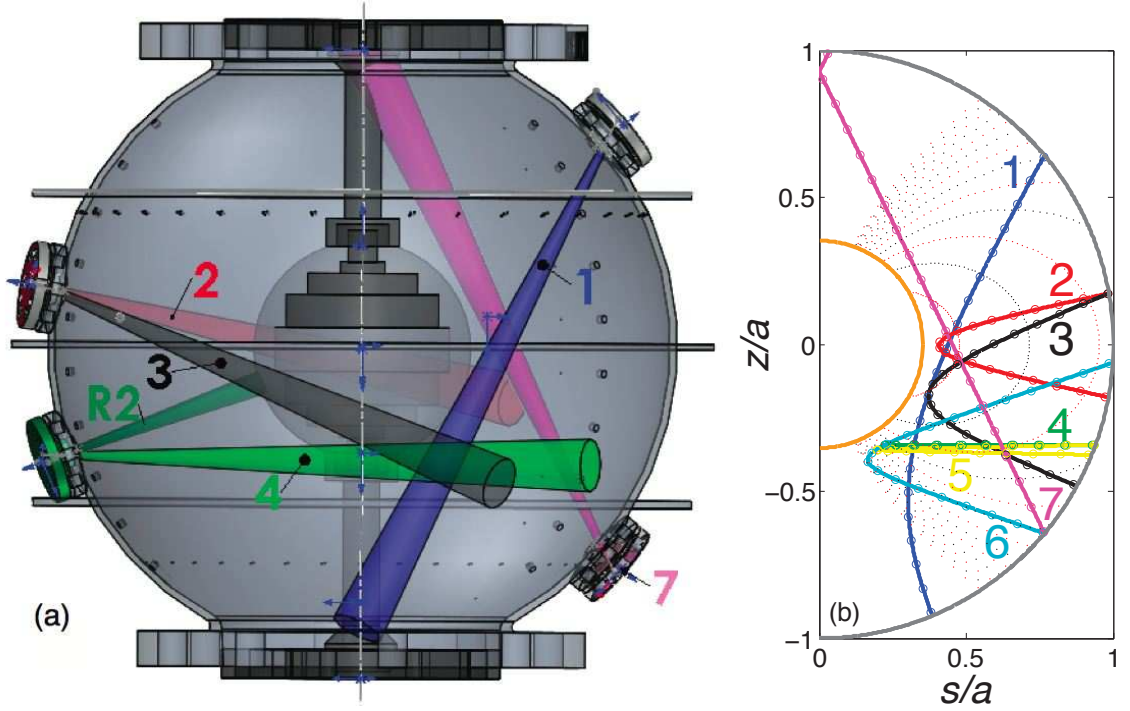

FIG. 3. (Color online) (a) 3D perspective view of the outer sphere and its interior. Caps at various latitudes hold ultrasonic velocity probes to perform UDV. The divergent ultrasonic beams emitted from each cap are shown in perspective with different colors (and numbers for the grayscale version). The five superimposed horizontal slices of magnets are assembled in the heart of the inner sphere. Differences in electric potential are measured between points from latitude $+45^\circ$ to latitude -45° , with steps of 10° (holes along a meridian at the right of the Figure). (b) Meridional view of the normalized coordinates $(s/a, z/a)$ covered by the ultrasonic trajectories numbered from 1 to 7. Some of the corresponding rays are plotted in (a) with the same color code (same numbers). The distance d from the outer sphere along the ultrasonic beam is marked by small dots drawn every 20 mm. The dotted lines are field lines of the imposed dipolar magnetic field.

177 The ultrasonic probes are held in circular stainless steel caps attached to the outer sphere,

178 as shown in FIG. 3(a). There are six locations with interchangeable caps on the outer
 179 sphere such that fluid velocities can be measured from any of these different positions. The
 180 thickness of the stainless steel wall between the probes and liquid sodium has been very
 181 precisely machined to 1.4 mm in order to insure the best transmission of energy from the
 182 probe to the fluid [47]. Small sodium oxides and/or gas bubbles are present and backscatter
 183 ultrasonic waves as in gallium experiments [46]. We keep the surface of the caps in contact
 184 with sodium as smooth and clean as possible to perform UDV measurements.

185 We use high temperature 4 MHz ultrasonic transducers (TR0405AH from Signal Pro-
 186 cessing) 10 mm long and 8 or 12 mm in diameter (piezoelectric diameter 5 or 7 mm). The
 187 measurements shown throughout the paper were performed with pulse repetition frequency
 188 (*prf*) varying from 3 kHz to 12 kHz and with a number of *prf* per profile varying from 8 to
 189 128. A present limitation of this UDV technique is that the maximum measurable veloc-
 190 ity obeys the following function $u_{\max} = c^2/4f_e P_{\max}$ where c is the ultrasonic velocity of the
 191 medium, f_e is the emitting frequency, and P_{\max} is the maximum measurable depth along
 192 the velocity profile. Applying this relationship to the parameters used in *DTS*, $P_{\max} \simeq 200$
 193 mm (approximative length of the first half of the beam in Figure 3) and $f_e = 4$ Mhz, the
 194 maximum measurable velocity is of the order 2.2 m/s. In particular cases, it is possible to
 195 overcome this limitation by using aliased profiles of velocity [43] as shown later in the paper.
 196 The spatial resolution of the velocity profiles is about 1 mm, and the velocity resolution is
 197 about 0.5%, or better for the aliased profiles.

198 We have measured both the radial and oblique components of velocity in the bulk of the
 199 spherical shell. The radial measurements were performed from the latitudes $+10^\circ$, -20° and
 200 -40° . The oblique measurements were performed from different locations and in different
 201 planes, along rays that all deviate from the radial direction by the same angle (24°). Thus,
 202 they all have the same length in the fluid cavity. At the point of closest approach, the rays
 203 are 11 mm away from the inner sphere. The seven oblique beams used in *DTS* are sketched
 204 in FIG. 3(b). The way to retrieve the meridional and azimuthal components of the velocity
 205 field along the ultrasonic beam is detailed in the Appendix.

206 We use UDV measurements to confirm the strong magnetic coupling between the inner
 207 rotating sphere and sodium. In a smaller version of *DTS* performed in water, maximum
 208 angular velocities (normalized by that of the inner sphere) of the order 0.16 are obtained
 209 for a hydrodynamic Reynolds number of 10^5 in the vicinity of the equatorial plane, close

210 to the rotating inner sphere [26]. For similar Re in *DTS*, sodium is in super-rotation close
211 to the inner rotating sphere and maximum measured velocities are instead around 1.2 (see
212 FIG. 11(b) for example).

213 2. *Magnetic field inside the sphere*

214 The measurement technique described so far does not requires probes that protrude inside
215 the sphere. In order to measure the magnetic field inside the sphere, in the liquid, we have
216 installed magnetometers inside a sleeve, which enters deep into the liquid. The external
217 dimensions of the sleeve are 114 mm (length inside the sphere) and 16 mm (diameter). It
218 contains a board equipped with high-temperature Hall magnetometers (model A1384LUA-T
219 of Allegro Microsystems Inc). We measure the radial component of the magnetic field at
220 radii (normalized by a the inner radius of the outer sphere) 0.93 and 0.74. The orthoradial
221 component is measured at 0.97 and 0.78, and the azimuthal component at 0.99, 0.89, 0.79,
222 0.69, 0.60 and 0.50. The sleeve is mounted in place of a removable port (at a latitude of
223 either 40° , 10° or -20°). A top view of the sleeve is shown in FIG. 6. The measured voltage
224 is sampled at 2000 samples/second with a 16-bit 250 kHz PXI-6229 National Instruments
225 acquisition card. The precision of the measurements (estimated from actual measurements
226 when $f = 0$) is about $140 \mu\text{T}$, and corresponds to about 20 unit bits of the A/D converter.
227 Magnetic fields up to 60 mT have been measured.

228 3. *Differences in electric potentials on the outer sphere*

229 Differences in electric potentials are measured along several meridians and along one
230 parallel of the outer sphere [30, 39, 41]. In the present study, we are interested in the
231 measurements performed along meridians since they are linked to the azimuthal flow velocity
232 u_φ (we denote (r, θ, φ) the spherical coordinates). The measurements are performed between
233 successive electrodes located from -45° to $+45^\circ$ in latitude, with electrodes 10° apart as
234 sketched in FIG. 3(a). We note $\Delta V_{40} = V_{45} - V_{35}$ the difference between the electric potential
235 at latitudes 45° and 35° . Electric potentials are measured by electrodes soldered to brass
236 bolts 3 mm long, those being screwed into 1 mm-diameter, 4 mm-deep blind holes drilled in
237 the stainless steel wall of the outer sphere. The measured voltage is filtered by an RC anti-

238 aliasing 215 Hz low-pass filter and then sampled at 1000 samples/second with a 16-bit 250
 239 kHz PXI-6229 National Instruments acquisition card. The precision of the measurements
 240 (estimated from actual measurements at $f = 0$) is about $80 \mu\text{V}$, and corresponds to about
 241 10 unit bits of the A/D converter. Electric potential differences up to 7 mV have been
 242 measured.

243 Denoting \mathbf{E} the electric field, we introduce the electric potential V through $\mathbf{E} = -\nabla V$,
 244 which is valid in a steady state. Then, the electric potential measurements are analysed using
 245 Ohm's law for a moving conductor, $\mathbf{j} = \sigma (\mathbf{u} \times \mathbf{B} + \mathbf{E})$ where σ is the electric conductivity,
 246 \mathbf{j} the electric current density vector, \mathbf{u} the velocity field and \mathbf{B} the magnetic field. If the
 247 meridional electric currents j_θ are small compared to $\sigma u_\varphi B_r$ in the fluid interior and away
 248 from the equatorial plane where $B_r = 0$, and if the viscous boundary layer adjacent to the
 249 outer sphere is thin, which ensures the continuity of E_θ through the layer, then the measured
 250 differences in electric potential depend on the product of the local radial magnetic field B_r
 251 by u_φ , the azimuthal fluid velocity:

$$\frac{\Delta V}{a\Delta\theta} = u_\varphi B_r, \quad (1)$$

252 where $\Delta\theta = 10^\circ$ is the angle between two electrodes. However, we shall question below the
 253 assumption on the smallness of j_θ , referred to as the frozen flux hypothesis.

254 4. *Velocity and torque measured from the motor driving the inner sphere*

255 The electronic drive of the motor entraining the inner sphere delivers an analog signal
 256 for its angular velocity and its torque. We checked and improved the velocity measurement
 257 by calibrating it using a rotation counter, which consists of a small magnet glued on the
 258 entrainment pellet and passing once per turn in front of a magnetometer. The torque signal
 259 is used to infer the power consumption in section II D.

260 C. **A typical experiment : a complete set of measurements**

261 A complete set of measurements performed during a typical experiment is analyzed below.
 262 The run was chosen to illustrate the various measurements but also to depict how the
 263 different observables evolve with f . During that run of 600 seconds, the inner sphere was

264 first accelerated from 0 to $f = 30$ Hz in around 120 seconds, then decelerated back to 0 during
 265 120 seconds. The inner sphere was then kept at rest for about 100 seconds and accelerated
 266 in the opposite direction to $f = -30$ Hz in 120 seconds. It returned to zero rotation in 120
 267 seconds again. That cycle of rotation is shown in FIG. 4. The torque delivered by the inner
 268 sphere motor is also shown and evolves clearly non-linearly during those cycles.

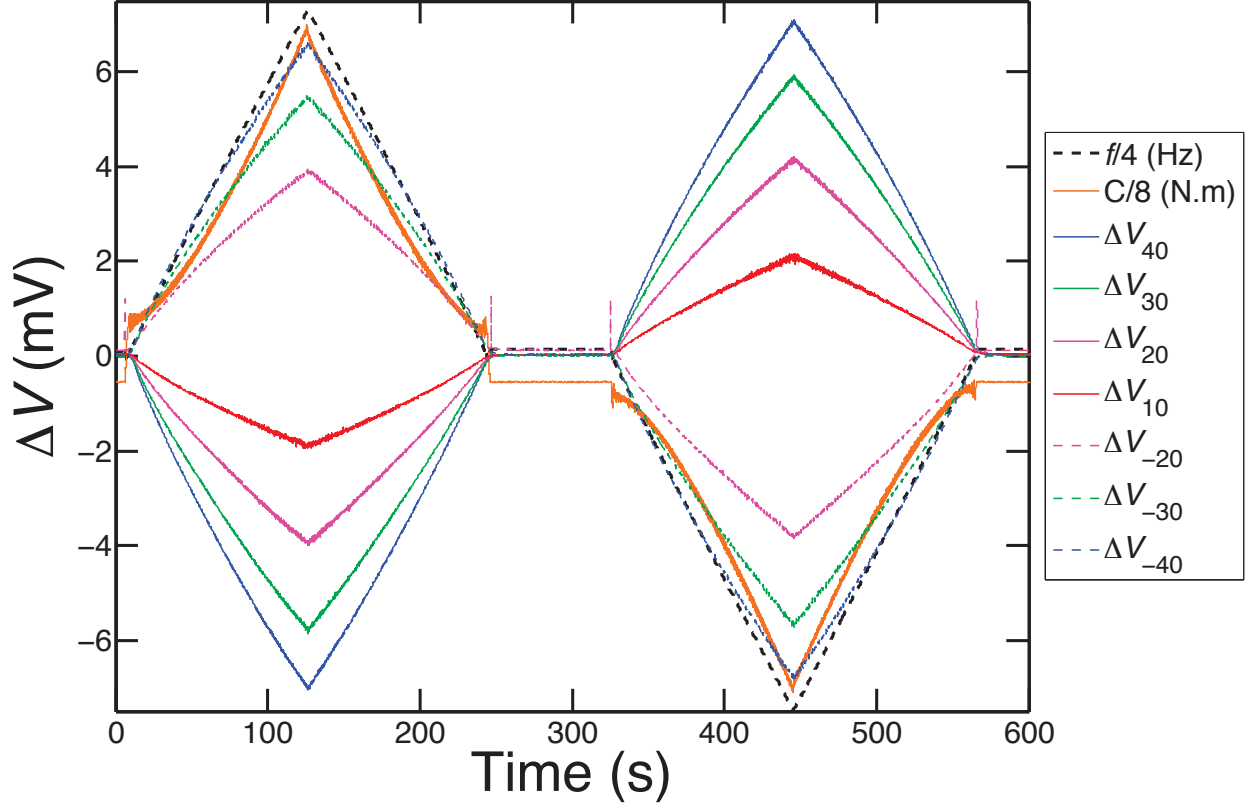

FIG. 4. (Color online) Records of the inner core rotation frequency f , torque C and differences in electric potential ΔV_{40} , ΔV_{30} , ΔV_{20} , ΔV_{10} , ΔV_{-20} , ΔV_{-30} , ΔV_{-40} as a function of time. The subscript denotes the latitude (in degrees) of the electric potential difference.

269 FIG. 4 shows electric potential records (see part II B 3) obtained during this experiment
 270 and time averaged over 0.1 s windows. The differences of potential vary in sync with the
 271 inner sphere rotation frequency as expected if the various ΔV 's measure the differential
 272 rotation between the liquid sodium and the outer sphere to which the electrodes are affixed
 273 (II B 3). However, it is also apparent that the fluid rotation as measured from the ΔV 's does
 274 not increase linearly with the inner sphere frequency. We interpret it as an indication that
 275 braking at the outer boundary, which opposes the entrainment by the inner core rotation,

276 varies non linearly with the differential rotation. As expected, records from electrodes pairs
277 are anti-symmetrical with respect to the equator, since the forcing is symmetrical while the
278 radial component of the imposed magnetic field changes sign across the equator.

279 FIG. 5 shows the fluid velocity $u(d)$ measured by UDV during the first half of the exper-
280 iment along the ray 6 as a function of time and distance. Velocity profiles were recorded
281 along a total distance $d \simeq 80$ mm. As demonstrated in FIG. 5(b), the velocity is aliased
282 since the maximum measurable velocity, for the ultrasonic frequency used during the exper-
283 iment, is exceeded. Since the azimuthal velocity profiles are quite simple in shape, it has
284 been straightforward to unfold those profiles and retrieve the correct amplitudes as shown in
285 FIG. 5(c). The evolution with f is similar to that of the electrodes, but indicates a stronger
286 leveling-off as f increases.

287 FIG. 6 shows the magnetic field induced inside the fluid during the typical experiment.
288 The measurements are taken in the sleeve placed at 40° latitude. The induced azimuthal field
289 in FIG. 6 (a) is measured at 6 different radii (given in section II B 2). Its intensity reaches
290 60 mT near the inner sphere and gets larger than the imposed dipole in some locations.
291 Note the simple evolution with f , which contrasts with that of the electric potentials and
292 velocities in that it increases with an exponent close to 1. The induced meridional field
293 (FIG. 6) is some 20 times weaker. It is dominated by fluctuations, and does not change
294 sign when f does. Note that the evolution with f is not monotonic. Similar behaviors are
295 observed at latitudes 10° and -20° .

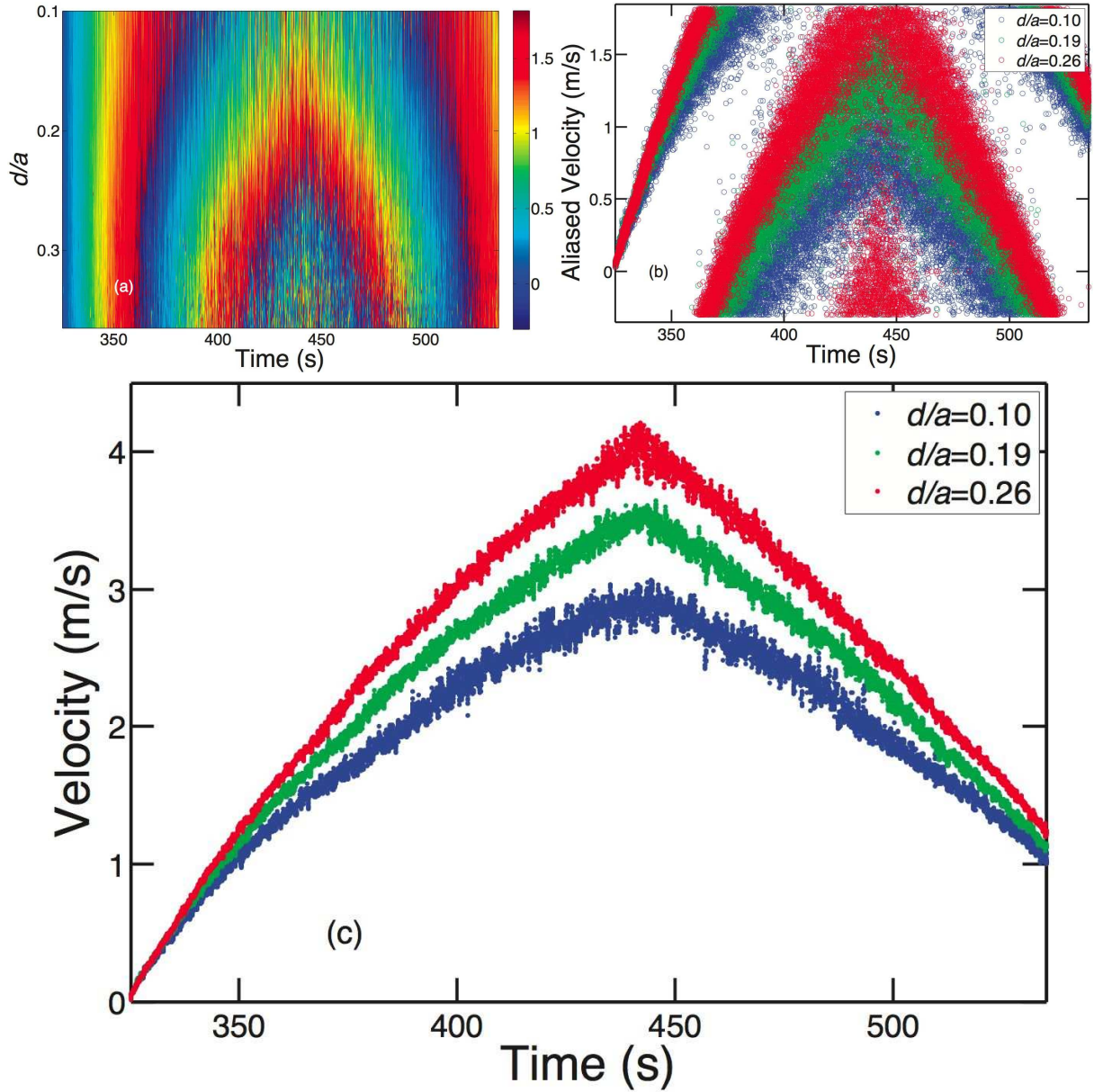

FIG. 5. (Color online) UDV measurements performed along the ray number 6 (see FIG. 3) during the second half of the typical experiment when the inner sphere was rotated from rest to -30 Hz and then back to rest. (a) Spatio-temporal representation of the measured velocity, given by the color scale (in m/s). (b) Velocity at three distances from the probe as a function of time, extracted from the spatio-temporal shown in (a). The velocity profiles are clearly aliased since the profiles are discontinuous. (c) After applying a median time-filtering window of 0.2 s and unfolding the profiles, the correct velocities are retrieved as a continuous function of time.

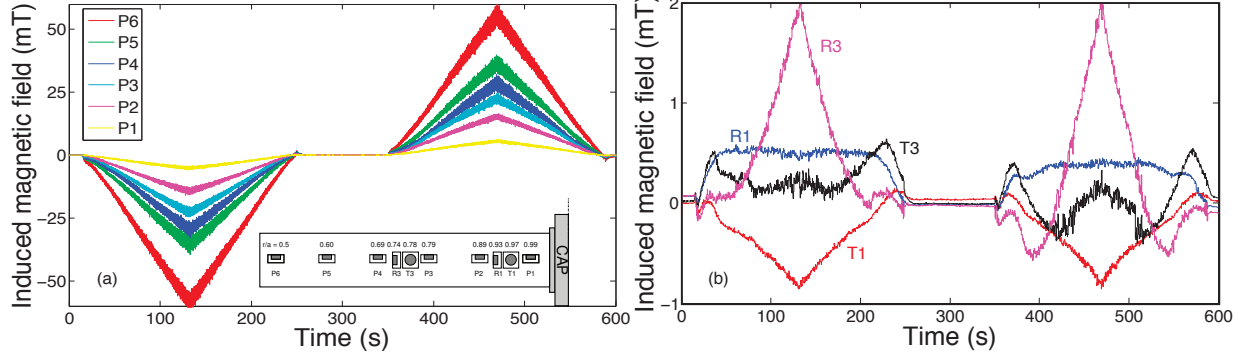

FIG. 6. (Color online) (a) Azimuthal b_ϕ , (b) radial b_r and orthoradial b_θ induced magnetic field at a latitude of 40° in the sleeve at different radial positions recorded during the two triangles sequence of FIG. 4. A top view of the sleeve at the bottom of (a) gives the radial position and the orientation of the various Hall magnetometers. The intensity of the induced azimuthal field reaches 60 mT near the inner sphere and has the sign of $-f$. The fluctuations reach about 10% of the mean. The meridional components of the induced magnetic field are much weaker and dominated by fluctuations, which have been filtered out here (0.2 Hz low-pass filter).

296 **D. Power scaling**

297 The power dissipated by the flow is shown in FIG. 7 as a function of the rotation frequency
298 f . It is computed from the product $\Gamma \times 2\pi f$, where Γ is the torque retrieved from the motor
299 drive. We subtracted the power measured with an empty shell (dash-dot curve) to eliminate
300 power dissipation in the mechanical set-up. The dissipation in the fluid reaches almost 8 kW
301 for the highest rotation frequency of the inner sphere ($f = \pm 30$ Hz). The small spread of
302 the data dots indicates that power fluctuations are small. The continuous line is the record
303 of power versus f when the inner sphere is ramped from 0 to -30 Hz as in FIG. 4. The
304 corresponding increase in kinetic energy only slightly augments power dissipation.

305 Power dissipation is found to scale as $f^{2.5}$, which does not differ from the scaling obtained
306 in the laminar numerical study of section VI. There, it is explained as the result of the
307 balance between the magnetic torque on the inner sphere and the viscous torque on the
308 outer sphere, assuming that the fluid angular velocity below the outer viscous boundary
309 layer is of the order of the inner sphere angular velocity. Although the outer boundary layer
310 displays strong fluctuations, the situation is completely different from Taylor-Couette water
311 experiments [48].

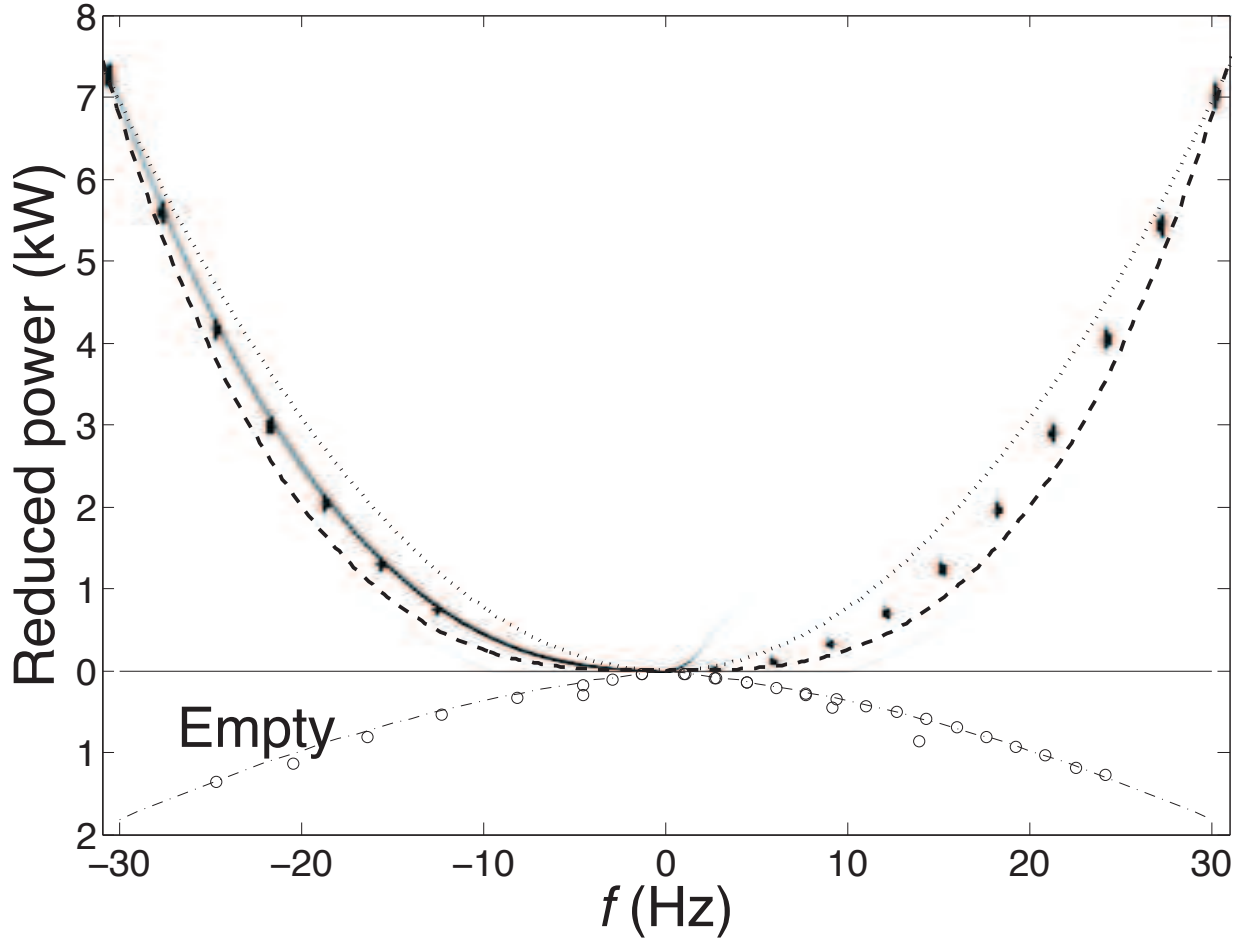

FIG. 7. Power dissipated by the flow in *DTS*. The data dots are from measurements of the motor torque for plateaus at given f . The dissipation in the mechanical set-up has been removed. It is obtained by rotating the inner sphere before filling the shell with sodium. It is drawn here upside-down in the lower panel (empty symbols) and can be fit by $\mathcal{P}_{\text{empty}}(\text{W}) = 4 \times |2\pi f| + 0.03 \times (2\pi f)^2$ (dash-dot curve). Dissipation in the flow scales as $f^{2.5}$, and is here compared with f^2 (dotted line) and f^3 (dashed line).

312 III. GOVERNING EQUATIONS

A spherical shell of inner radius b and outer radius a is immersed in an axisymmetric dipolar magnetic field \mathbf{B}_d :

$$\mathbf{B}_d(r, \theta, \varphi) = B_0 \left(\frac{b}{r}\right)^3 [2 \cos \theta \mathbf{e}_r + \sin \theta \mathbf{e}_\theta],$$

313 where (r, θ, φ) are spherical coordinates. The outer boundary is kept at rest and the inner
 314 sphere rotates with the constant angular velocity $\Omega = 2\pi f$ along the same axis as the dipole
 315 field that it carries. We assume that the electrically conducting fluid filling the cavity is
 316 homogeneous, incompressible and isothermal. We further assume that the flow inside the
 317 cavity is steady.

318 The inner body consists of a magnetized innermost core enclosed in an electrically con-
 319 ducting spherical solid envelope of finite thickness d_b . We choose b as unit length, $b\Omega$ as unit
 320 velocity, $\rho b^2 \Omega^2$ as unit pressure, and $b^2 \Omega B_0 / \eta = \text{Rm} B_0$ as unit of induced magnetic field \mathbf{b}
 321 ($\mathbf{B} = \mathbf{B}_d + \text{Rm} \mathbf{b}$). Then, the equations governing the flow \mathbf{u} and the induced magnetic field
 322 are:

$$\nabla \cdot \mathbf{u} = 0 \tag{2}$$

$$\nabla \cdot \mathbf{b} = 0 \tag{3}$$

$$(\mathbf{u} \cdot \nabla) \mathbf{u} = -\nabla p + \Lambda ((\mathbf{B}_d \cdot \nabla) \mathbf{b} + (\mathbf{b} \cdot \nabla) \mathbf{B}_d) + \text{Re}^{-1} \nabla^2 \mathbf{u} \tag{4}$$

$$\nabla^2 \mathbf{b} = -\nabla \times (\mathbf{u} \times \mathbf{B}), \tag{5}$$

323 where p is a modified pressure. The notation Λ refers to the Elsasser number, classically
 324 used for rotating flows in the presence of a magnetic field. That number Λ compares the
 325 magnetic and inertial forces in the vicinity of the magnetized inner sphere. In the shell
 326 interior, the two forces are better compared by a "local" Elsasser number: $\Lambda_l = (b/r)^6 \Lambda$
 327 (with $(b/a)^6 \simeq 1.83 \cdot 10^{-3}$). Finally, it is of interest to introduce the Hartmann number
 328 Ha that compares the magnetic and viscous forces. We have $\text{Ha} = (\Lambda \text{Re})^{1/2}$. In the shell
 329 interior, the number $(b/r)^3 \text{Ha}$ is more appropriate to compare the two forces. Typical values
 330 of these dimensionless numbers can be found in TABLE II.

331 The set of equations (2-5), where the non linear terms are neglected, was the subject
 332 of the analytical study of Dormy et al. [31] that described how the differential rotation

TABLE II. Typical values of the dimensionless numbers in the *DTS* experiment, computed for $f = \Omega/2\pi = 25$ Hz.

Re	$b^2\Omega/\nu$	$1.3 \cdot 10^6$
Rm	$b^2\Omega/\eta$	10
Λ	$\sigma B_0^2/\rho\Omega$	1.9
Ha	$(\text{Re}\Lambda)^{1/2}$	$1.6 \cdot 10^3$

333 between the fluid interior and the outer sphere drives an influx of electrical currents from
 334 the mainstream into the outer viscous Hartmann boundary layer. Electrical currents flow
 335 along the viscous boundary layer and return to the conducting inner body along a free shear
 336 layer located on the magnetic field line tangent to the outer boundary at the equator. As
 337 these electrical currents cannot flow exactly parallel to the magnetic field line, they produce
 338 a Lorentz force, which sustains "super-rotation" of the fluid. Recent studies have extended
 339 the analysis to the case of a finitely conducting outer sphere [49, 50]. On increasing the
 340 conductance of the container, Dormy et al. (2010) found that more and more electrical
 341 currents leak into the solid boundary and the super-rotation rate gets as large as $O(\text{Ha}^{1/2})$.
 342 Though the analytical results have set the stage for the interpretation of the experimental
 343 results, the neglected non linear effects are crucial in the *DTS* experiment, even for the
 344 smallest rate of rotation of the solid inner body.

345 Upon reversal of Ω , u_φ and b_φ change into $-u_\varphi$ and $-b_\varphi$ whilst the other components of
 346 \mathbf{u} and \mathbf{b} are kept unchanged.

347 IV. DIFFERENTIAL ROTATION

348 A. Transition between the Ferraro and geostrophic regimes

349 In this section, we use the UDV records to delve into the geometry of isorotation surfaces.

350 The L number associated to each dipolar magnetic field line enters the equation of the
351 surfaces spanned by dipolar lines of force:

$$r = L \sin^2 \theta . \quad (6)$$

352 Accordingly, L gives the radius of the intersection of the magnetic field line with the
353 equatorial plane. The notation L refers to the L-value (or L-shell parameter) widely used to
354 describe motions of low energy particles in the Earth's magnetosphere. FIG. 8 shows that,
355 for $L \leq 2.7$, the angular velocity measured along rays 2 and 3, which are the most appropriate
356 to map the azimuthal velocity field, is, to a large extent, a function of L only. Thus, the
357 angular velocity does not vary along magnetic field lines near the inner sphere, where the
358 magnetic field is the strongest. We interpret this result as a consequence of Ferraro's theorem
359 of isorotation. The latter is written:

$$\mathbf{B}_d \cdot \nabla \left(\frac{u_\varphi}{s} \right) = 0. \quad (7)$$

360 It is obtained from the φ component of the induction equation for steady fields, ignoring
361 magnetic diffusion. Although often invoked in the framework of ideal MHD (where magnetic
362 diffusion is negligible), Ferraro's law does not require a large Rm [51]. It implies that there
363 is no induced magnetic field and that, as a consequence, the magnetic force is exactly zero.
364 More precisely, deviations from this law lead to the induction of a magnetic field, which
365 produces a magnetic force that tends to oppose this induction process. Writing $\mathbf{u} = \mathbf{u}_0 + \mathbf{u}_1$,
366 where \mathbf{u}_0 obeys the equation (7), we obtain $b \approx u_1$ from (5). Then, the momentum equation
367 (4) yields $u_1 \approx (\text{Re}\Lambda)^{-1} u_0 = \text{Ha}^{-1} u_0$ (as numerically verified in [35]) when the inertial term,
368 on the left hand side, can be neglected. Ferraro's law of isorotation, though, is not the only
369 way to cancel the magnetic force. In the presence of electric currents parallel to the magnetic
370 field, the magnetic force remains zero and the equation (7) can be violated [50, 51]. For the
371 geometry of the *DTS* experiment, it cannot happen along the innermost dipolar field lines
372 that join the two hemispheres, without touching the outer sphere. Indeed, symmetry with
373 respect to the equatorial plane E implies that the currents do not cross E.

374 Thus, the observation of a velocity field obeying Ferraro's law is a symptom that magnetic
 375 forces predominate in that region. Note that the fact that the two legs of the profile along
 376 ray 2 show similar velocities even for large L only probes the symmetry of the flow with
 377 respect to the equatorial plane.

379 Now, FIG. 9 shows that for $s \geq 0.6$ the azimuthal velocity is largely a function of s
 380 only. There, the Proudman-Taylor theorem holds and azimuthal flows are geostrophic as
 381 the inertial forces predominate. In contrast with the case of a rotating outer sphere (see
 382 Figure 7 in [39]), there is no region of uniform rotation: zonal velocities are z -independent
 383 but vary with the distance to the z axis.

384 The transition between the Ferraro and geostrophic regimes (FIG. 10) occurs at smaller
 385 distances from the axis as the rotation frequency of the inner core increases (unfortunately,
 386 we cannot get reliable UDV data for larger f). It takes place where the local Elsasser number
 387 Λ_l , which compares the magnetic and inertial forces, is of order 1. It is noteworthy that
 388 the Elsasser number Λ defines the location (cylindrical radius) where $\Lambda_l = 1$. The surface
 389 $\Lambda_l = 1$ separates two regions of the fluid cavity. Inside this surface, the magnetic forces
 390 predominate whether outside it the rotation forces are the most important ones. Finally,
 391 the value of Λ largely defines the geometry of isorotation surfaces.

392 In the geostrophic region, magnetic stress integrated on the geostrophic cylinders remains
 393 strong enough to overcome the viscous friction at the outer boundary and to impart a rapid
 394 rotation to the fluid but becomes weaker than the Reynolds stress (which can be represented
 395 as a Coriolis force). As a result, the fluid angular velocity is still of the order of the angular
 396 velocity of the inner sphere and the velocities are predominantly geostrophic.

397 B. Inversion of velocity profiles

398 Flow velocity is constrained by its projection on the several ultrasonic rays that we
 399 shoot. We invert the Doppler velocity profiles for the large scale mean flow, assuming that
 400 the steady part of the flow is symmetric about the axis of rotation and with respect to the
 401 equatorial plane. A poloidal/toroidal decomposition,

$$\mathbf{u} = u_\varphi \mathbf{e}_\varphi + \nabla \times (u_p \mathbf{e}_\varphi), \quad (8)$$

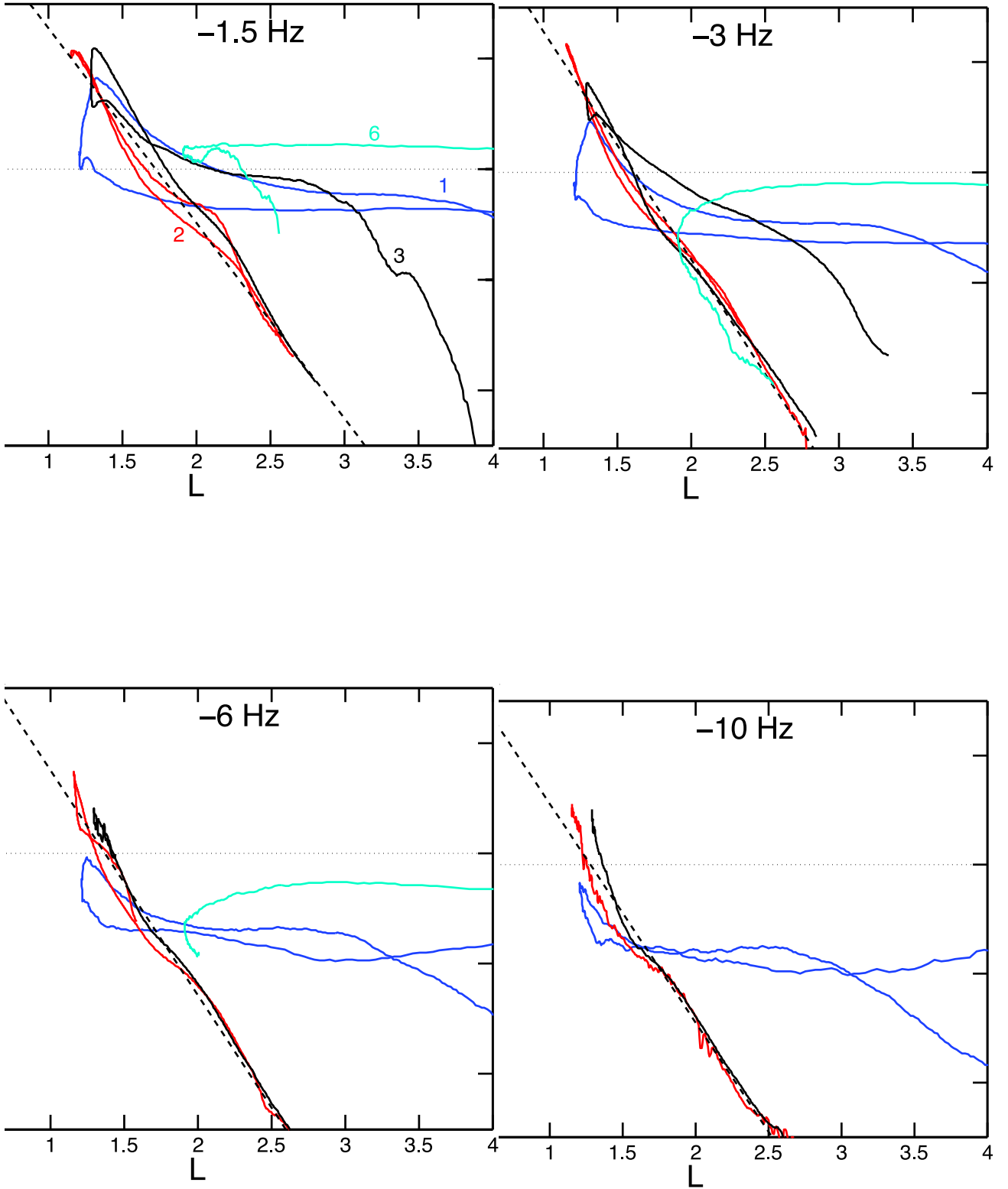

FIG. 8. (Color online) Rotation frequency of the fluid sodium over the inner sphere rotation frequency as a function of the magnetic field lines L for four ultrasonic velocity profiles (trajectories 1, 2, 3 and 6, with the same color code as in FIG 3) and four inner sphere rotation frequencies ($f = -1.5, -3, -6$ and -10 Hz). The dashed line is a straight line to help the eye.

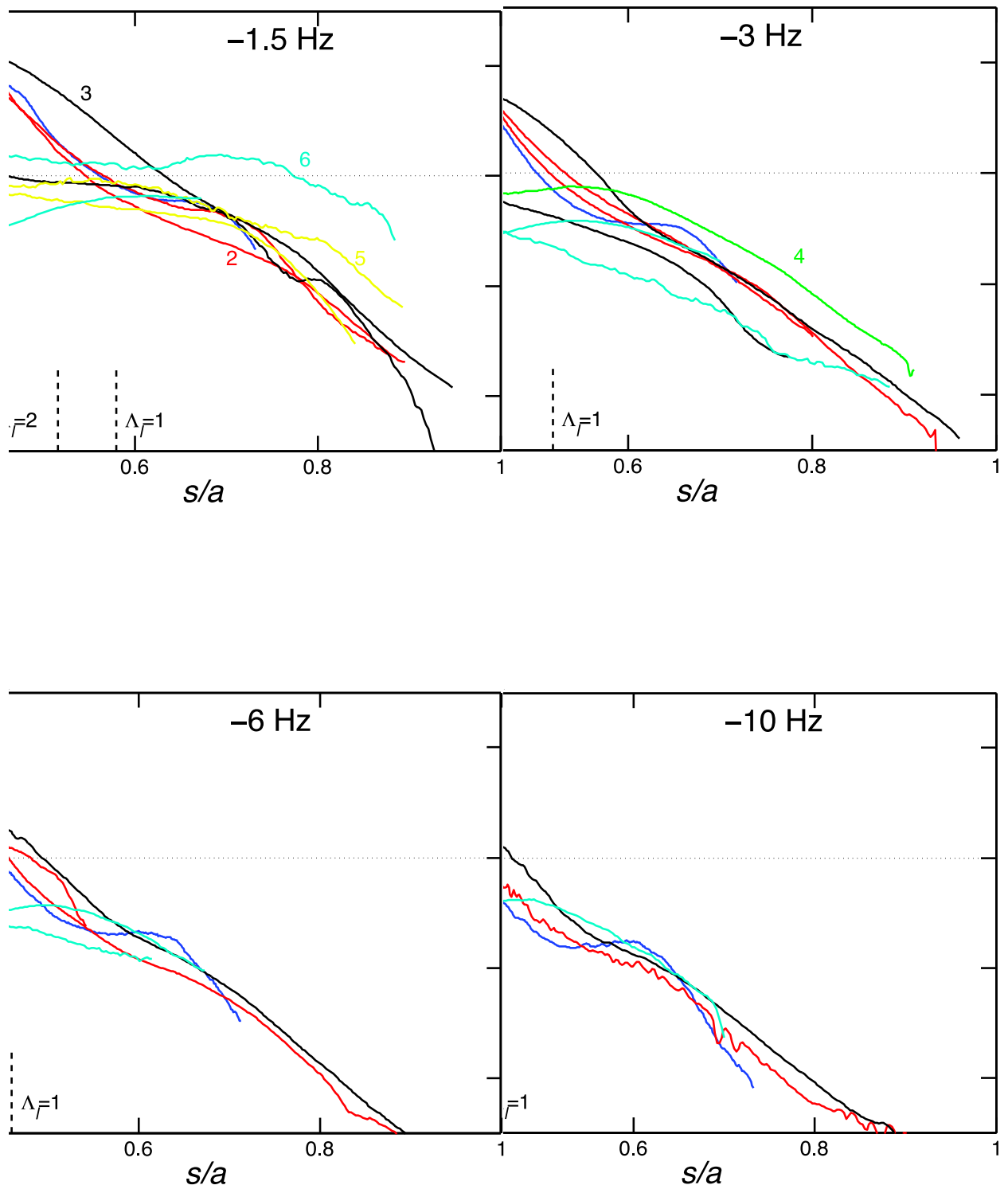

FIG. 9. (Color online) Rotation frequency of the fluid sodium normalized by the inner sphere rotation frequency as a function of s , for various ultrasonic velocity profiles and four inner sphere rotation frequencies ($f = -1.5, -3, -6$ and -10 Hz). The colors of the profiles (numbers) follow the conventions laid out in FIG. 3.

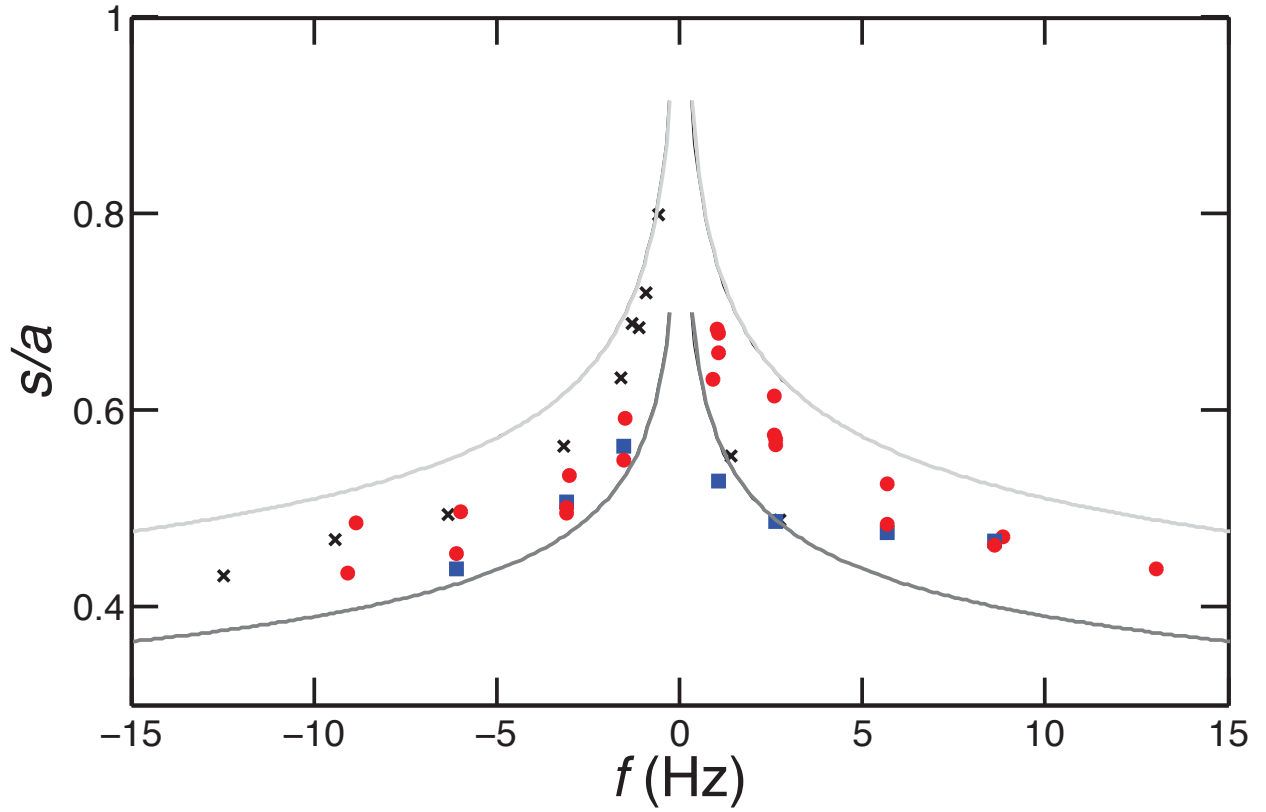

FIG. 10. (Color online) Normalized cylindrical radius s/a along the UDV trajectories number 1 (blue square), 2 (red circle) and 3 (black cross) where $f_{fluid} = f$ (*i.e.* $f^* = 1$) as a function of the inner sphere rotation frequency. Pale line : $\Lambda_l = 0.5$, Dark line : $\Lambda_l = 2.5$.

402 is employed. We first consider the azimuthal velocity u_φ , which is expanded in associated
 403 Legendre functions with odd degree and order 1, *i.e.*

$$u_\varphi(r, \theta) = \sum_{l=0}^{l_{max}} u_\varphi^l(r) P_{2l+1}^1(\cos \theta) . \quad (9)$$

404 The functions $u_\varphi^l(r)$ are decomposed into a sum from $k = 0$ to k_{max} of Chebyshev poly-
 405 nomials of the second kind on the interval $[0, 1]$ mapped onto the interval $[b/a, 1]$, *i.e.* the
 406 fluid domain. The azimuthal velocity is not constrained to vanish at the inner and outer
 407 boundaries, in order to account for the presence of thin unresolved boundary layers.

408 Azimuthal velocities are more than 10 times larger than the poloidal (*i.e.* meridional)
 409 velocities. Nevertheless, the latter projects onto the ultrasound rays. We take the difference
 410 of the profiles acquired for f and $-f$ in order to eliminate this small contribution (the
 411 meridional circulation does not change sign while the azimuthal velocity does).

412 FIG. 11 shows the isovalues of angular frequency f^* inverted for $f = \pm 3$ Hz, with
 413 $l_{max} = 3$ and $k_{max} = 7$. A crescent of super-rotation is present near the inner sphere.
 414 There, isorotation contours roughly follow magnetic field lines, in agreement with Ferraro's
 415 theorem, as anticipated above. At larger cylindrical distance from the inner sphere, the
 416 flow becomes geostrophic: the contour lines are vertical. We note that angular velocities
 417 just above the north pole of the inner sphere do not comply with Ferraro's law. Instead,
 418 velocities decrease to quite low values inside the cylinder tangent to the inner sphere. Such
 419 violations have been shown to occur when the electric conductivity of boundaries is high
 420 [50, 51]. We speculate that we might be in this situation inside the tangent cylinder because
 421 the opening of the sphere at the top and bottom (see FIG. 3) replaces the poorly conducting
 422 stainless steel wall by sodium.

423 FIG. 11 compares the synthetic angular velocity profiles to the observed Doppler velocity
 424 profiles along the various rays. Note that super-rotation is clearly visible in the raw profiles.
 425 The drop in velocity just above the inner sphere is constrained by profiles 4 (green) and 6
 426 (cyan), but its vertical extent is not.

427 C. f_{fluid} deduced from differences in electric potential and from UDV

428 As in the previous study of *DTS* with rotating outer sphere [39], we observe that the
 429 amplitudes of the differences in electric potential ΔV 's vary linearly with ΔV_{40} , the pro-

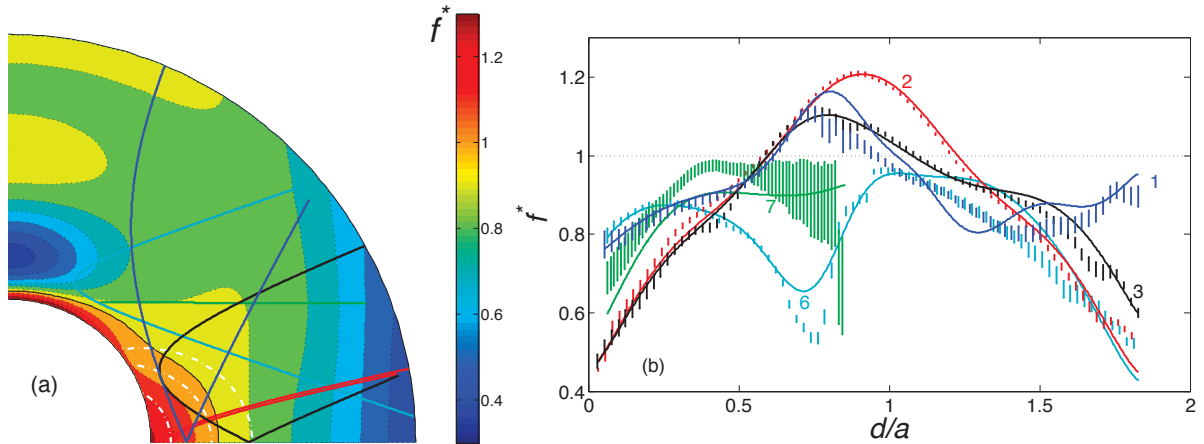

FIG. 11. (Color online) (a) Reconstructed isovalue map of fluid angular frequency f^* (the fluid angular frequency normalized by f) at $f = \pm 3$ Hz in a meridional plane, assuming axisymmetry and symmetry with respect to the equator. Three dipolar field lines (dash-dot white) are superimposed in the angular velocity maps. Super-rotation ($f^* \gtrsim 1$) is clearly visible near the inner sphere, where the Ferraro law of isorotation applies. Contours become vertical further away, where geostrophy dominates. The fluid frequency is higher than 0.4 everywhere except in thin unresolved boundary layers. The color lines are the projection in the upper half (s, z) plane of the ultrasonic rays used in the inversion (see FIG. 3). (b) Comparison between the measured ultrasonic Doppler f^* (shown by their error bars) and the synthetic profiles (solid lines) computed from the angular frequency map of (a) for $f = \pm 3$ Hz. The x -axis gives the distance along the ray (in a units). The corresponding rays are plotted in (a) with the same color code (and indicated with trajectory numbers referring to FIG. 3).

430 portionality factor increasing from the equator toward the poles due in particular to the
 431 increase of B_r in formula (1). We show however in the present study that measuring the
 432 electric potential does not yield a reliable indicator of the angular velocity f^* using formula
 433 (1). In FIG. 12, we compare the normalized fluid angular velocity f^* retrieved from the
 434 ΔV 's, for four different latitudes, to f^* obtained directly by UDV at the nearest measured
 435 point, around $d/a = 0.1$. The frequencies f^* obtained from ΔV and from UDV in FIG. 12,
 436 would be similar if both measurement techniques were only sensitive to u_φ in the interior
 437 below the outer viscous boundary layer. The strong discrepancy between these two sets of
 438 frequencies reveals instead that the outer boundary layer in *DTS* cannot simply be reduced
 439 to a Hartmann layer, outside of which the meridional currents j_θ can be neglected. We

440 further discuss this point in the numerical part VI.

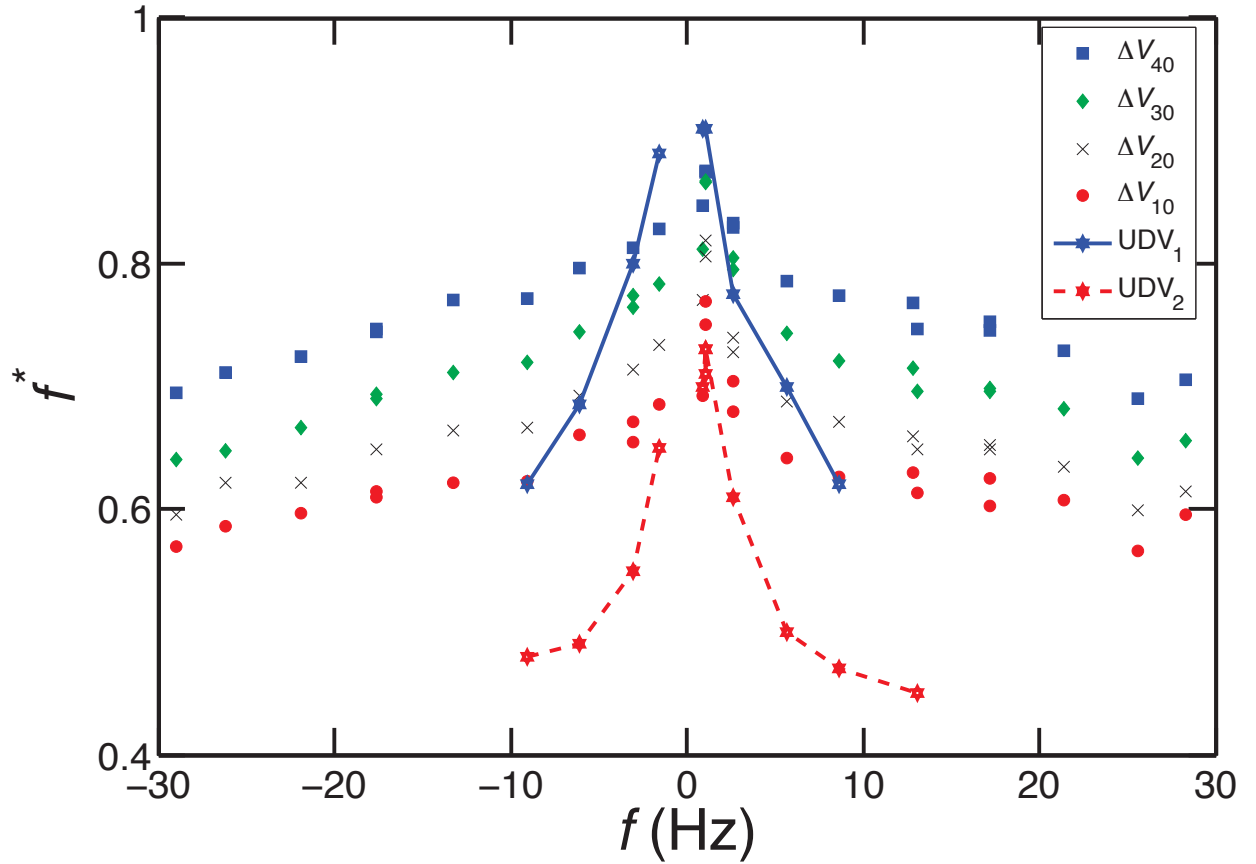

FIG. 12. (Color online) f^* deduced from the measurements of ΔV using formula (1). Blue line : f^* value obtained with UDV measurements on the trajectory number 1 at the distance $d/a = 0.1$. Dashed red line : f^* value obtained with UDV measurements on the trajectory number 2 for $d/a = 0.1$.

441 V. MERIDIONAL CIRCULATION

442 The meridional circulation is constrained from Doppler velocity profiles of the radial ve-
 443 locity (shot along the radial direction), from profiles shot in a meridional plane, and from the
 444 projection of the meridional velocity on "azimuthal" shots. The latter is obtained by taking
 445 the sum of the profiles acquired for f and $-f$, in order to eliminate the azimuthal contribu-
 446 tion. The same is done for the radial and meridional profiles to remove any contamination
 447 from azimuthal velocities.

448 The poloidal velocity scalar u_P of equation (8) is expanded in associated Legendre func-
 449 tions with even degree and order 1, *i.e.*

$$u_P(r, \theta) = \sum_{l=0}^{l_{max}} u_P^l(r) P_{2l}^1(\cos \theta). \quad (10)$$

450 The radial u_r and orthoradial u_θ components of velocity are then obtained as:

$$u_r(r, \theta) = \sum_{l=0}^{l_{max}} \frac{u_P^l(r)}{r} \frac{1}{\sin \theta} \frac{d}{d\theta} (\sin \theta P_{2l}^1(\cos \theta)). \quad (11)$$

451

$$u_\theta(r, \theta) = - \sum_{l=0}^{l_{max}} \left(\frac{u_P^l(r)}{r} + \frac{du_P^l(r)}{dr} \right) P_{2l}^1(\cos \theta). \quad (12)$$

452 The functions $u_P^l(r)$ are decomposed into a sum of $\sin(k\pi(r - b/a)/(1 - b/a))$ from $k = 0$
 453 to k_{max} . The radial velocity is thus constrained to vanish at the inner and outer (rigid)
 454 boundaries, but the orthoradial velocity is not, in order to account for the presence of thin
 455 unresolved boundary layers. FIG. 13 shows the streamlines of the meridional circulation
 456 inverted for $f = \pm 3$ Hz, with $l_{max} = 4$ and $k_{max} = 8$. The fluid is centrifuged from the
 457 inner sphere in the equatorial plane and moves north in a narrow sheet beneath the outer
 458 boundary. It loops back to the inner sphere in a more diffuse manner. Meridional velocities
 459 are more than ten times weaker than azimuthal velocities.

460 FIG. 14 compares the synthetic radial and meridional profiles to the observed Doppler
 461 velocity profiles along the various rays. Velocities are normalized by $2\pi f a$.

462 Over a decade (from $f = 1.5$ Hz to $= 15$ Hz), radial velocities are consistently centrifugal
 463 at 10° latitude and centripetal at 40° , and are roughly proportional to f . The radial profiles
 464 at 20° are more complex and evolve with f , indicating a non-monotonic evolution of the
 465 meridional circulation, also evidenced by the records of the r and θ components of the
 466 induced magnetic field inside the fluid (see FIG. 6). FIG. 15 compiles the *rms* value of
 467 radial velocity at 20° for various f . Note that the fluctuations are larger than this value,
 468 which is almost 50 times smaller than azimuthal velocities.

469 VI. COMPARISON WITH NUMERICAL SIMULATIONS

470 Two previous numerical studies are particularly relevant to our work. Hollerbach et al.
 471 studied exactly the *DTS* configuration but for values of Λ much larger than its value in the
 472 experiment [29]. They focus their study on the modification of the linear solution by inertial

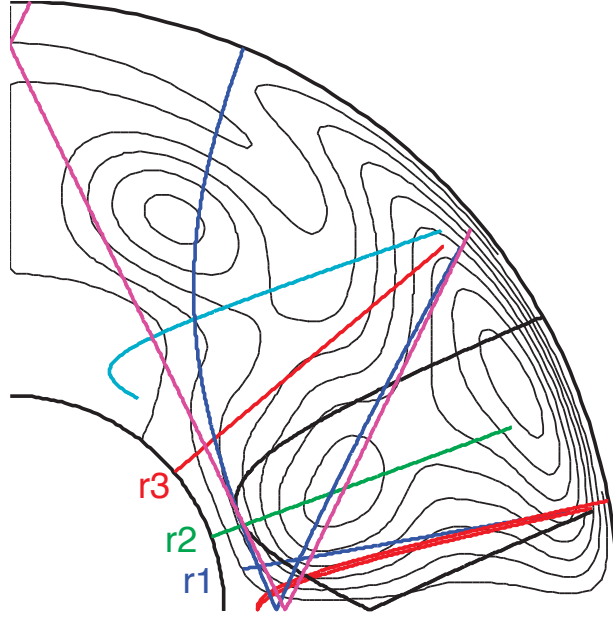

FIG. 13. (Color online) Reconstructed stream lines of the meridional circulation at $f = \pm 3$ Hz in a meridional plane, assuming axisymmetry and symmetry with respect to the equator. The interval between lines is 1.6×10^{-3} . The fluid is centrifuged away from the inner sphere in the equatorial region and moves up to the pole along the outer boundary. The color lines are the projection in the upper half (s, z) plane of the ultrasonic rays used in the inversion.

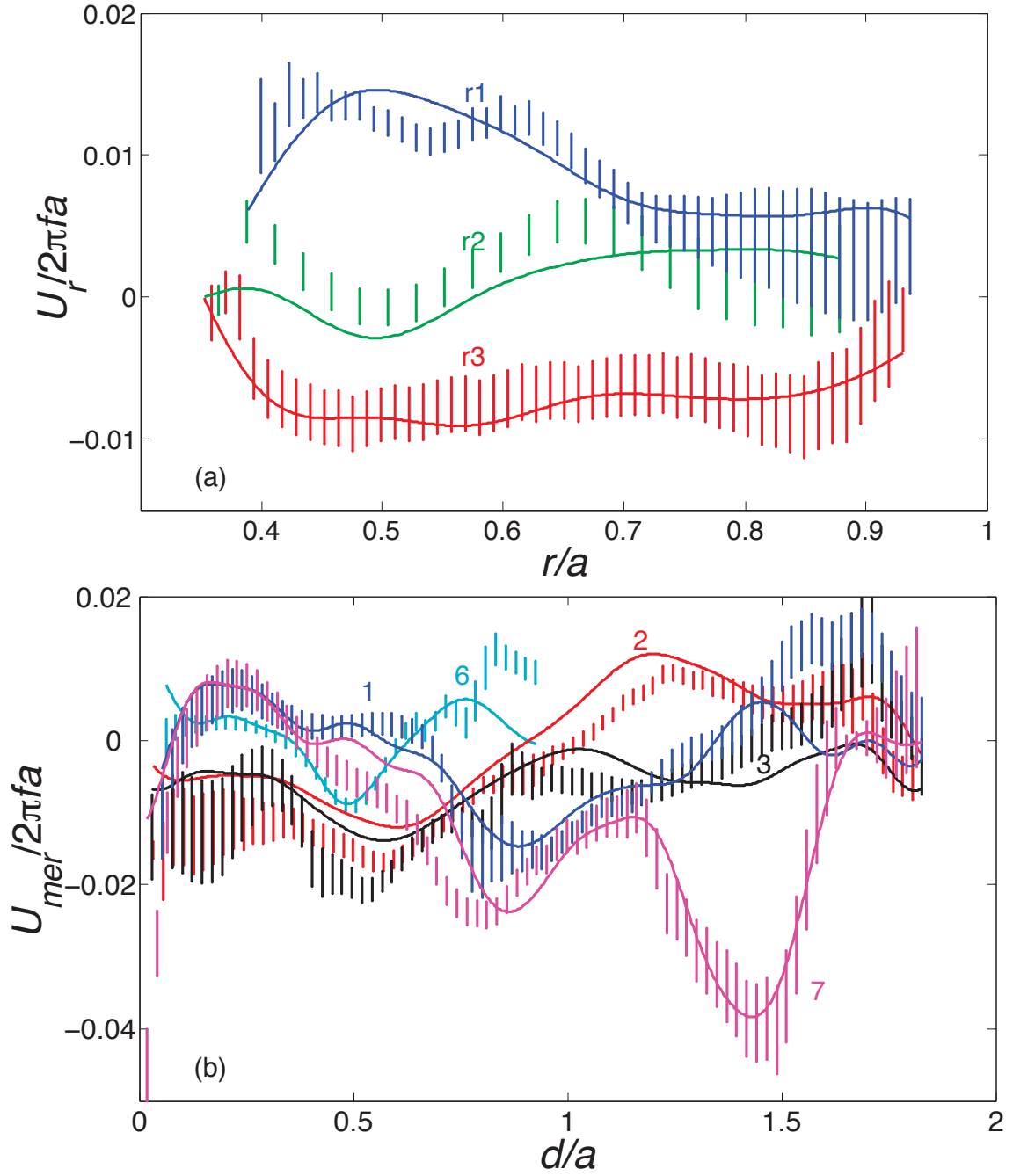

FIG. 14. (Color online) Comparison between the measured ultrasonic Doppler velocity profiles (shown by their error bars) and the synthetic profiles (solid lines) computed from the meridional circulation map of FIG. 13 for $f = \pm 3$ Hz. (a) Radial profiles along the radial direction r_1 , r_2 and r_3 shown in FIG. 13. (b) "Azimuthal" profiles. The contribution from the azimuthal flow has been removed by taking the sum of profiles acquired for f and $-f$. The x -axis gives the distance along the ray (in a units) and the y -axis is the velocity measured along the ray, adimensionalized by $2\pi f a$. The corresponding rays are plotted in FIG. 13 with the same color code (for the grayscale version, the trajectory numbers in (b) refers to those in FIG. 3).

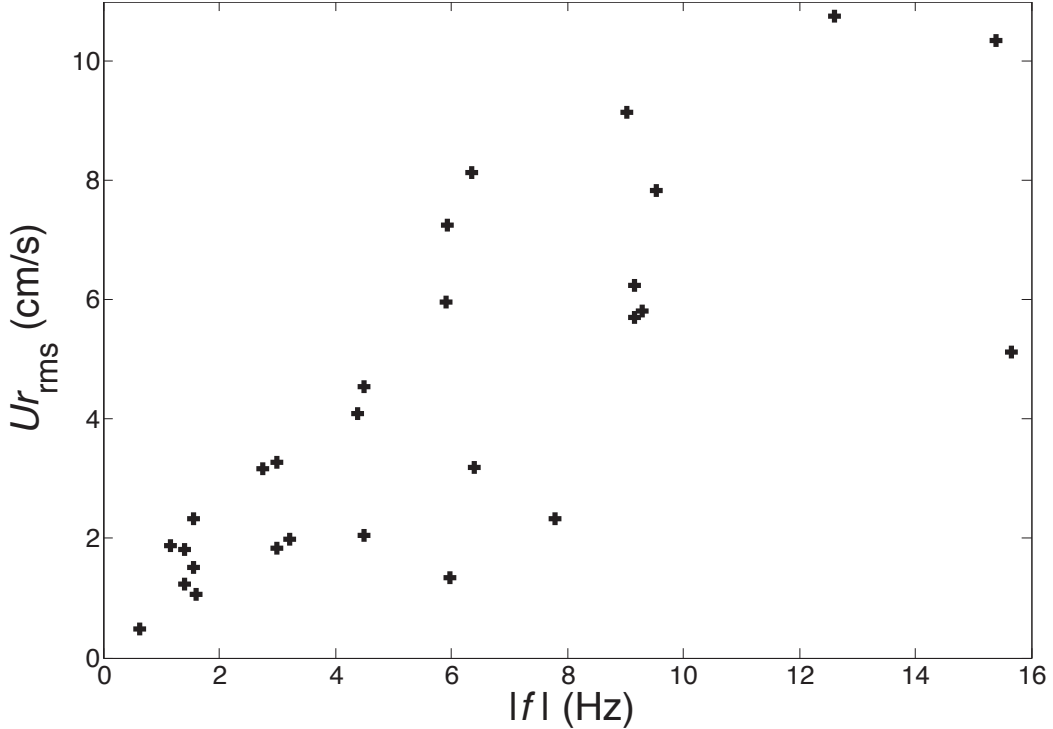

FIG. 15. Compilation of the *rms* radial velocity amplitude as a function of the absolute value of f . The *rms* velocity is computed from Doppler velocimetry profiles shot at a latitude of 20° , from 3 cm beneath the outer shell down to the inner sphere (to avoid spurious values close to the outer boundary). Radial velocity is roughly proportional to f but there is a large dispersion, as the shape of the profiles changes with f . Note that for $f = 10$ Hz, the tangential velocity on the inner sphere reaches 465 cm/s.

473 effects, stressing that the magnetic field line tangent to the outer sphere at the equator loses
474 its significance in the non linear regime. As a result of the relatively large value of Λ , the
475 inertial effects remain too weak -when the outer sphere is at rest- to make a geostrophic
476 region arise at large distances from the axis. The solutions of Garaud [52] (see the figures
477 7 and 11) for a slightly different problem do show the transition between a Ferraro and a
478 geostrophic regions. In her model, which pertains to the formation of the solar tachocline,
479 a dipolar magnetic field permeates a thick spherical shell as in *DTS*, the rotation of the
480 outer boundary is imposed and the rotation of the inner boundary is a free parameter: a
481 condition of zero torque is imposed on that boundary. Numerical models [29, 39] of the
482 *DTS* experiment when the outer sphere is rotating also clearly show a Ferraro region near

483 the inner sphere where the magnetic field is strong and a geostrophic region in the vicinity
 484 of the equator of the outer sphere. We argue below that all these results obtained for a
 485 rotating outer sphere provide us with a useful guide to interpret the numerical solutions
 486 when the outer sphere is at rest.

487 **A. The numerical model**

488 The model consists of four nested spherical layers (see FIG. 16). The fluid layer is enclosed
 489 between a weakly conducting outer container and a central solid sphere comprised of an inner
 490 insulating core and of a strongly conducting outer envelope.

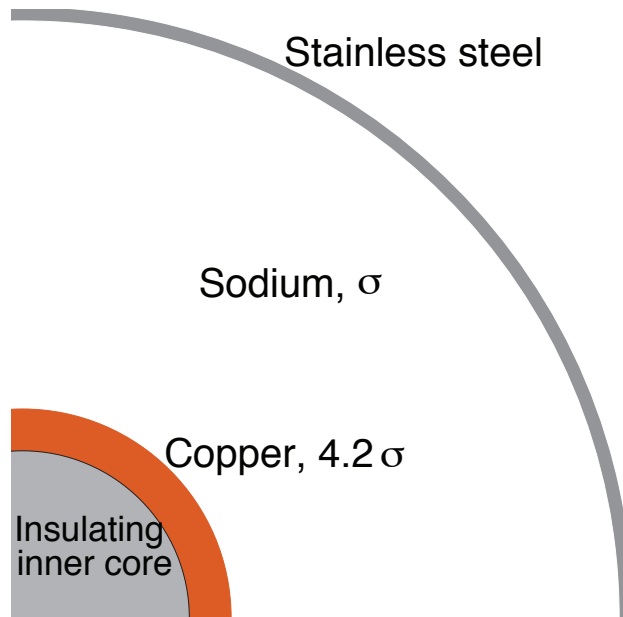

FIG. 16. (Color online) Geometry of the numerical model. The relative conductance of the solid outer shell is $\sigma_b \delta / \sigma a = 1/336$, with σ_b and δ respectively the conductivity and the thickness of the outer sphere. It reproduces the experimental value with σ_b chosen as the conductivity of stainless steel at 140°C. The conductivity ratio between the layers 2 and 3 reproduces the ratio (4.2) between the conductivity of copper and sodium.

491 The velocity field is decomposed as stated in the definitions (8) and (9). The variables
 492 $u_\varphi^l(r)$ and $u_p^l(r)$ are then discretized in radius. Analogous decompositions of variables de-
 493 noted $b_\varphi^l(r)$ and $b_p^l(r)$ are employed to represent the induced magnetic field. The truncation
 494 level l_{max} (see (9)) is 120 and at least 450 unevenly spaced points are used in the radial

495 direction. Specifically, the density of points strongly increases close to the boundaries in
496 order to resolve the viscous boundary layers.

497 The equations (4) and (5), modified to include all the non linearities and the time deriva-
498 tives of \mathbf{u} and \mathbf{b} , are transformed into equations for u_φ^l , u_p^l , b_φ^l and b_p^l . We treat the non linear
499 terms explicitly. To advance from one time step to the next, we use an Adams-Bashforth
500 method. Diffusive terms, however, are treated implicitly. Finally, Laplace's equation in
501 spherical coordinates separates which makes it easy to write the magnetic boundary condi-
502 tions.

503 The dimensionless numbers Re and Λ are chosen so that steady solutions exist and are
504 stable, with $Pm \ll 1$ (Pm enters the definition of the unit induced field). We strive to repro-
505 duce the experimental values of Λ and R_m . Solutions are obtained after time-stepping the
506 equations until a stationary or periodic state is reached. They have been successfully com-
507 pared to solutions obtained with another numerical code PARODY, which is not restricted
508 to axisymmetric variables [26, 53].

509 It is not possible to simulate the Reynolds number of the experiment, which is about 10^6 .
510 For the experimental range of Λ , steady solutions are obtained with $Re \sim 10^3$.

511 B. Steady axisymmetric solutions

512 FIG. 17 displays a typical solution for the angular and meridional velocities that illustrates
513 well the experimental results. The fluid rotates faster than the magnetized inner body in its
514 vicinity. There, the angular velocity is constant along magnetic field lines of force. Further
515 away of the inner core, the zonal shear becomes almost geostrophic. In addition to these
516 features that we have retrieved from the experimental results, the numerical solution displays
517 recirculation in the outer boundary layer at high latitude. There, the interior flow largely
518 consists in rigid rotation and the boundary layer has the characteristics of a Bödewadt layer
519 with a region of enhanced angular rotation.

520 For large enough Re (*e.g.* $(a/b)^2 Re = 10^4$ with $(b/a)^2 Ha = 20$), circular waves are
521 present in the Bödewadt layer, above 60° of latitude. They propagate towards the axis.
522 Similar waves had been reported before in simulations of the flow between a rotating and
523 a stationary disk in the absence of a magnetic field [54]. There, they eventually die out.
524 Thus, the persistence of propagation of circular waves in the boundary layer attached to the

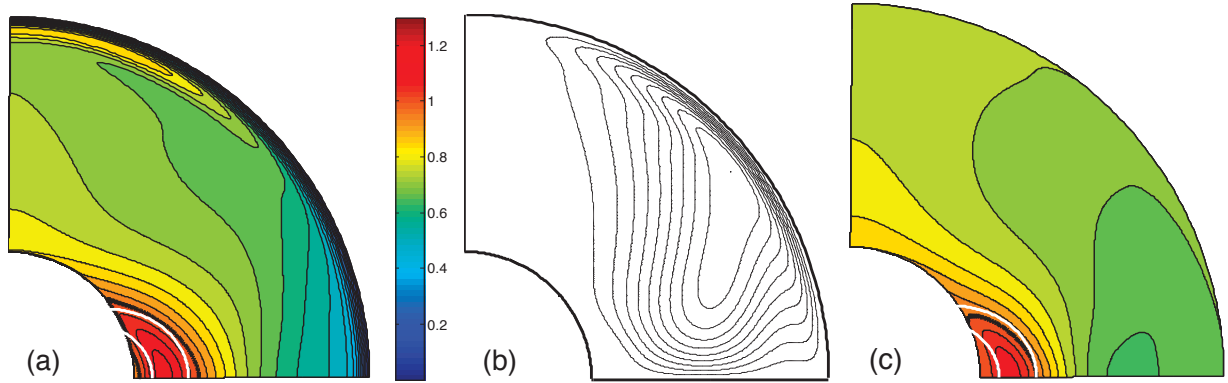

FIG. 17. (Color online) (a) Angular and (b) meridional velocity in a meridional plane for $Re = 9.5 \cdot 10^2$, $Ha = 163$, and $Pm = 10^{-3}$. (c) angular velocity estimated from V , using (1). Two dipolar field lines (white) are superimposed in the angular velocity maps, and the thick black contour line is where the angular velocity is unity.

525 sphere at rest may be attributed to the presence of a magnetic field. On the other hand,
 526 these waves arise for larger Re as Ha is augmented. Their emergence delimits the domain
 527 of steady solutions.

528 We have checked that the thickness of the outer boundary layer in the numerical solution
 529 scales as $\Omega^{-1/2}$. Note that it corresponds to 3 mm for $\Omega = 1.5 \text{ s}^{-1}$ and the viscosity of
 530 liquid sodium. The fluid rotation is driven by the electromagnetic torque acting at the inner
 531 boundary against the viscous torque at the outer boundary. We have found that both the
 532 viscous torque on the inner surface and the electromagnetic torque on the outer surface are
 533 negligible. Comparing different simulations, we have also checked that the main viscous
 534 torque scales as $\sim \Omega^{3/2}$, as expected from the thickness of the Bödewadt layer. Thus, the
 535 power required to drive the fluid rotation scales as $\Omega^{5/2}$, as does the experimentally measured
 536 power, and torque measurements do not give indications on turbulence (see section IID).

537 The angular rotation just below the outer viscous layer scaled by the inner core angular
 538 rotation decreases with Re in agreement with the experimental results. On the other hand,
 539 the angular rotation that would be inferred from the electric potential differences calculated
 540 at the outer surface using expression (1) increases with Re . FIG. 17(c) displays the angu-
 541 lar velocity as estimated from the electric potential, according to equation (1). It can be
 542 compared to FIG. 17(a). The actual shear is well retrieved where the magnetic force pre-
 543 dominates, in the region where Ferraro's law of isorotation holds. There, the electric current

544 density \mathbf{j} is limited by the strength of the magnetic force, which needs to be balanced by an-
545 other force. That restriction makes it possible to neglect \mathbf{j} in Ohm's law. Then, predictions
546 made from (1) are correct. On the other hand, the actual shear is not well recovered in the
547 geostrophic region where the electric current density is not limited by the strength of the
548 magnetic field. There, the frozen-flux relation (1) can be violated. We thus explain why the
549 electric potential measurements at the surface of the *DTS* experiment do not yield a good
550 prediction of the angular velocity immediately below the outer viscous boundary layer.

551 Our first discussion [30] of the electric potential measurements was based on a numerical
552 model calculated for the experimental values of Ha and thus for too large values of Λ . As a
553 result, the magnetic force, in the numerical model, was dominant in the entire fluid layer and
554 the frozen-flux relationship (1) was verified, at least away from the equator where $B_r = 0$.
555 However, equation (1), becomes less and less valid as Re is increased and Λ decreased, in
556 agreement with the divergence that has been experimentally observed (see the FIG. 12)
557 between the angular velocity calculated from (1) and the actual velocity.

558 Incidentally, cranking up the rotation of the magnetized inner sphere stabilizes the fluid
559 circulation, at least within a certain parameter range. We have calculated the time-averaged
560 solution (not shown) for the same parameters as the steady solution illustrated by FIG. 17,
561 but for a lower Re . Both the flow and the induced magnetic field are periodic for this set of
562 parameters. A second meridional roll, which is centripetal in the equatorial plane, turns up
563 in the outer region. There, it creates a disk-shaped region where the rotation is slow and
564 the solution is strikingly different from the almost geostrophic solution (FIG. 17) obtained
565 for a slightly larger value of Re .

566 **C. Comparison between numerical simulations and experimental results**

567 We find that reproducing the Elsasser number Λ , rather than a combination of Λ and Re
568 such as the Hartmann number $\text{Ha} = (\text{Re}\Lambda)^{1/2}$, is the key factor to recover the experimental
569 results. The parameters for the solution displayed in FIG. 17 correspond to $\Lambda = 28$, which
570 is the appropriate value for experiments with $\Omega = 1.5 \text{ s}^{-1}$. With $\text{Pm} = 10^{-3}$, the value of
571 the magnetic Reynolds number is about right. It remains too small for the poloidal field to
572 be much different from the imposed dipole field (again for the parameters of FIG. 17).

573 FIG. 18 shows that numerical solutions are able to satisfactorily reproduce the ultrasonic
574 measurements of angular velocity, obtained for the same values of Λ , as expected from the
575 similitude of the angular velocity maps 11 and 17. The simulated velocities have weaker
576 amplitude than the measured ones in much of the fluid though. We have checked that
577 increasing Re , whilst keeping Λ constant, favours enhanced corotation between the fluid
578 and the inner core. As our calculations are for much smaller Re than the values realized in
579 the experiment, that result may explain the remaining discrepancy between measured and
580 simulated velocities.

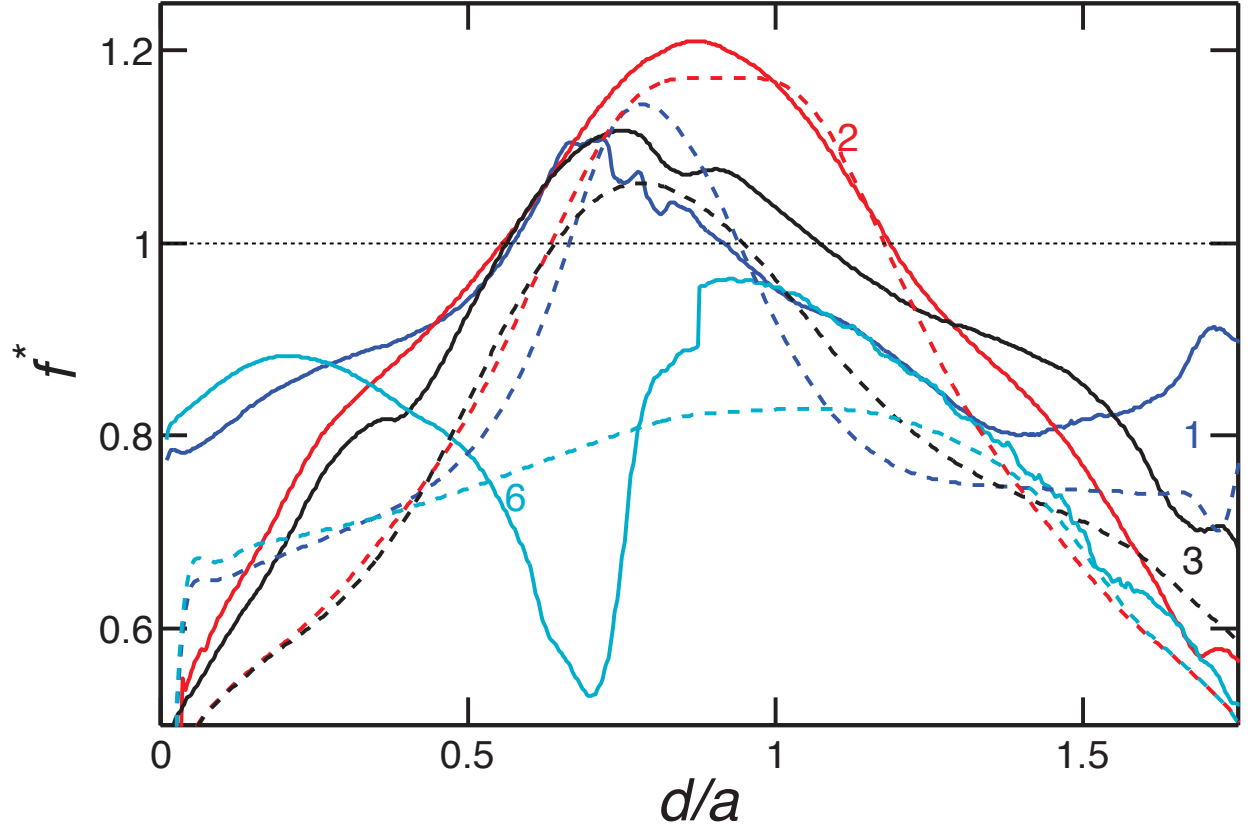

FIG. 18. (Color online) Angular velocity along the ultrasonic rays as a function of the distance from the probe: measured (solid lines, 3 Hz, $\Lambda = 16$) and retrieved from a time-averaged numerical solution (dashed lines, $\text{Re} = 1.5 \cdot 10^3$, $\text{Ha} = 163$, $\text{Pm} = 10^{-3}$, $\Lambda = 18$). The color lines refers to those used to define the ultrasonic beams in the FIG. 3 (the numbers also refers to the ultrasonic beams numbers defined in the FIG. 3). The error bars of the experimental data are shown in FIG. 11.

581 VII. DISCUSSION AND CONCLUSION

582 In the presence of an imposed magnetic field, which favors solid body rotation, the inertial
583 forces largely reduce to a Coriolis force, even for large Reynolds numbers. Experimental
584 results can thus be interpreted using a single dimensionless number, the Elsasser number.
585 In that respect, experimental results obtained with global rotation [39] provide a better
586 guide to interpreting the present results than the linear situation studied by Dormy et al.
587 [28, 31]. We estimate that, in *DTS*, the rotation frequency f should be less than 0.1 Hz for
588 the latter to be approached.

589 Experiments have been conducted with the inner sphere rotating in the range -30 Hz
590 $\leq f \leq 30$ Hz. We have been able to map extensively the shear in the fluid cavity from
591 ultrasonic Doppler velocimetry for $|f| \leq 10$ Hz. Our observations provide a very clear
592 experimental illustration of Ferraro's law of isorotation, demonstrating the predominance
593 of magnetic forces near the inner sphere. They also exhibit a strong super-rotation: in the
594 region where magnetic forces dominate, the fluid angular velocity gets 30% larger than that
595 of the inner sphere. This contrasts with the results obtained by Dormy et al. [28] when
596 global rotation is present, which indicate that the phenomenon of super-rotation is hindered
597 by the Coriolis force. The experimental results obtained in our previous study with global
598 rotation [39] could not address this issue and we plan to run additional experiments for that
599 purpose.

600 The experiments also display a clear violation to Ferraro's law: quite low angular velocities
601 are observed just above the inner sphere, where the magnetic field is strongest (see FIG. 11).
602 We suspect that this is due to the presence of sodium at rest at the top and bottom of the
603 cylinder tangent to the inner sphere. Indeed, such violations have been shown to occur when
604 the electric conductivity of boundaries is high [50, 51].

605 We could follow the evolution of induced magnetic field, electric potentials and power
606 across the full range of forcing. In a first approximation, all observables associated with the
607 azimuthal flow (which dominates) can be described by a universal solution, both velocities
608 and induced magnetic field scaling with f . In a second approximation, the increase of the
609 dimensional fluid velocity with f thins the viscous boundary layer at the outer sphere and
610 increases friction accordingly, thus reducing the adimensional velocity of the fluid inside
611 the sphere. At the same time, the effective Coriolis force that results from the non-linear

612 $(\mathbf{u} \cdot \nabla)\mathbf{u}$ term increases with respect to the (linear) Lorentz force: the geostrophic region
 613 extends further towards the inner sphere. This explains that the fluid velocity increases with
 614 f less rapidly than f (FIG. 5) at large f whilst the torque instead increases more rapidly
 615 than f (FIG. 4) (the electric potentials follow an intermediate trend). The outer friction
 616 torque is balanced by the magnetic torque at the inner boundary. This is consistent with
 617 an increase of the induced magnetic field, near the solid inner body, that is steeper than f
 618 (see FIG. 6). On the other hand, the description of Nataf and Gagnière [55] pertains to the
 619 region where the shear is geostrophic. There, the increased torque at the outer boundary is
 620 balanced by the magnetic torque on the geostrophic cylinders in the interior, which results
 621 from the shearing of the imposed dipolar field. The direct measurement of the velocity (up to
 622 10 Hz, see FIG. 9) shows that the adimensionalized shear does not change significantly with
 623 f even though the velocity itself decreases. In addition, the induced azimuthal magnetic
 624 field that we measure inside the sphere (FIG. 6), for the whole range of f , increases more
 625 rapidly than f . At large f , we observe that b_φ gets larger than the imposed dipolar field in
 626 much of the fluid layer. Eventually, this induced field is large enough to modify the overall
 627 magnetic field, and the resulting flow.

628 This last regime, only achieved because the magnetic Reynolds number is large enough,
 629 is probably the most interesting one. Unfortunately, we cannot directly measure the flow
 630 velocities with the ultrasound technique at these very large f . Less direct techniques are
 631 now required to investigate the zonal shear for $f > 10$ Hz. Inertial waves modified in the
 632 presence of the dipolar and the induced magnetic fields have been inferred from records of
 633 the electric potential along parallels at the surface [41] and of the magnetic field along a
 634 meridian. Both their period and their wavenumber vary with the geometry of the differential
 635 rotation in the cavity. Hopefully, it will be possible to invert the zonal shear from the records
 636 of magneto-inertial waves.

637 Guided by the numerical model, we find that electric field measurements are difficult to
 638 interpret, particularly in the equatorial region where the radial magnetic field B_r vanishes.
 639 The frozen-flux approximation (1) holds when there is a mechanism that keeps under control
 640 the strength of the electrical currents [56]. This is the reason why the magnetic Reynolds
 641 number Rm is not relevant to discuss the validity of the frozen-flux approximation in our
 642 quasi-steady experiment. That approximation has predictive power, instead, in regions
 643 where the magnetic force is dominating. In the *DTS* experiment, it corresponds to the

644 inner region close to the magnet where $\Lambda \geq 1$.

645 In a geophysical context, a similar approach is routinely used [57] to invert the velocity
646 field at the Earth's core surface from models of the time changes of the geomagnetic field,
647 the so-called secular variation. Taking the example of a quasi steady state, this geophysical
648 application has been criticized from a strictly kinematic standpoint [58]. We reckon in-
649 stead that it is necessary to consider the balance of forces to decide whether the frozen-flux
650 hypothesis holds, at least for a quasi steady state as illustrated by the *DTS* experiment.

651 Features of the experiment that only depend upon dimensionless numbers that do not
652 involve diffusivities have been simulated numerically. An analogous explanation has been
653 put forward to explain the intriguing successes of geodynamo simulations [5].

654 **ACKNOWLEDGMENTS**

655 The *DTS* project has been supported by Fonds National de la Science, Agence Nationale
656 de la Recherche (Research program VS-QG, grant number BLAN06-2.155316), Institut Na-
657 tional des Sciences de l'Univers, Centre National de la Recherche Scientifique, and Université
658 Joseph-Fourier. We are thankful to Dominique Grand and his colleagues from *SERAS* who
659 conducted the design study of the mechanical set-up. The magnetic coupler was computed
660 by Christian Chillet. We thank two anonymous referees for useful comments.

661 **Appendix: Angular and meridional velocity along the ultrasonic oblique rays**

662 The seven oblique ultrasonic rays shot in *DTS* are sketched in FIG. 3. We define the
 663 declination D as the angle between the beam and the meridional plane (D counted positively
 664 eastwards), the inclination I as the angle between the projected beam in the meridional plane
 665 and the radial direction (I counted positively upwards) and λ as the latitude of the ultrasonic
 666 probe. Using those definitions, TABLE III give the characteristics of the beams.

TABLE III. Latitude λ , inclination I , and declination D (in degrees) at the origin of the shots
 (on the outer sphere) of the oblique ultrasonic beams in *DTS*.

Trajectory number and color	λ	I	D
1, blue	40	21.1	11.7
2, red	10	2.2	23.9
3, black	10	12.5	-20.6
4, green	-20	20	-13.5
5, yellow	-20	21.1	-11.7
6, cyan	-40	21.1	11.7
7, magenta	-40	-24	0

667 **1. Angular velocity**

668 Along these oblique beams, the projection $u(d)$ (d is the distance from the probe) of the
 669 velocity is a combination of the components u_r , u_θ and u_φ of the total velocity field. Velocity
 670 $u(d)$ is counted positive in the shooting direction. We assume that the mean fluid flow is
 671 axisymmetric, and also $(u_r, u_\theta) \ll u_\varphi$, the meridional velocities amplitude in *DTS* being less
 672 than 10% the amplitude of the azimuthal velocities. Using projections along the beam, we
 673 retrieve the angular velocity $\omega(d)$ along trajectories 1 to 6 using the following relationship

$$\omega(d) = -\frac{u(d)}{a \cos \lambda \sin D}. \quad (\text{A.1})$$

674 **2. Meridional velocity**

675 We have also exploited the observation that the meridional velocity does not change sign
 676 when the rotation of the inner sphere is reversed - it remains centrifugal in the equatorial
 677 plane - whereas the angular velocity does change sign. Thus, combining measurements
 678 obtained with two opposite rotation rates of the inner core, we can separate azimuthal and
 679 meridional velocities.

680 Assuming now that the mean meridional velocity is axisymmetric and using projections,
 681 we can retrieve the radial velocity

$$u_r(d) = \frac{u(d)r(d)}{d - a \cos D \cos I}, \quad (\text{A.2})$$

682 and the orthoradial velocity

$$u_\theta(d) = \frac{u(d)r(d)s(d)}{a[a \cos D \cos \lambda \sin I - d \cos^2 D \cos(\lambda + I) \sin I + d \sin^2 D \sin \lambda]}, \quad (\text{A.3})$$

683 where $r(d) = \sqrt{x^2 + y^2 + z^2}$ is the spherical radius and $s(d) = \sqrt{x^2 + y^2}$ is the cylindrical
 684 radius at the measurement point. They (x, y, z) coordinates of the measurement point are
 685 given by:

$$x(d) = a \cos \lambda - d \cos D \cos(\lambda + I) \quad (\text{A.4})$$

$$y(d) = -d \sin D \quad (\text{A.5})$$

$$z(d) = a \sin \lambda - d \cos D \sin(\lambda + I) \quad (\text{A.6})$$

686 [1] W. M. Elsasser, Phys. Rev., **69**, 106 (1946).
 687 [2] W. M. Elsasser, Phys. Rev., **70**, 202 (1946).
 688 [3] J. Verhoogen, *Energetics of the Earth* (National Academy of Sciences, Washington, 1980).
 689 [4] G. A. Glatzmaier and P. H. Roberts, Nature, **377**, 203 (1995).
 690 [5] U. Christensen and J. Aubert, Geophys. J. Int., **166**, 97 (2006).
 691 [6] F. Takahashi, M. Matsushima, and Y. Honkura, Phys. Earth Planet. Inter., **167**, 168 (2008).
 692 [7] A. Sakuraba and P. Roberts, Nature Geoscience (2009).
 693 [8] E. Dormy, J.-P. Valet, and V. Courtillot, Geochem. Geophys. Geosyst., **1** (2000).

- 694 [9] J.-P. Poirier, *Introduction to the Physics of the Earth's Interior* (Cambridge University Press,
695 Cambridge, UK, 2000).
- 696 [10] E. Dormy and A. M. Soward, *Mathematical aspects of natural dynamos* (CRC Press/Taylor
697 Francis, 2007).
- 698 [11] A. Gailitis, O. Lielausis, E. Platacis, S. Dement'ev, A. Cifersons, G. Gerbeth, T. Gundrum,
699 F. Stefani, M. Christen, and G. Will, *Phys. Rev. Lett.*, **86**, 3024 (2001).
- 700 [12] R. Stieglitz and U. Müller, *Phys. Fluids*, **13**, 561 (2001).
- 701 [13] Y. Ponomarenko, *J. Appl. Mech. Tech. Phys.*, **14**, 775 (1973).
- 702 [14] G. O. Roberts, *Phil. Trans. R. Soc. London, Ser. A*, **271**, 411 (1972).
- 703 [15] M. Berhanu, R. Monchaux, S. Fauve, N. Mordant, F. Pétrélis, A. Chiffaudel, F. Daviaud,
704 B. Dubrulle, L. Marié, F. Ravelet, M. Bourgoin, P. Odier, J.-F. Pinton, and R. Volk, *Europhys.*
705 *Lett.*, **77**, 59001 (2007).
- 706 [16] R. Monchaux, M. Berhanu, M. Bourgoin, M. Moulin, P. Odier, J.-F. Pinton, R. Volk, S. Fauve,
707 N. Mordant, F. Pétrélis, A. Chiffaudel, F. Daviaud, B. Dubrulle, C. Gasquet, L. Marié, and
708 F. Ravelet, *Phys. Rev. Lett.*, **98**, 044502 (2007).
- 709 [17] D. R. Sisan, N. Mujica, W. A. Tillotson, Y.-M. Huang, W. Dorland, A. B. Hassam, T. M.
710 Antonsen, and D. P. Lathrop, *Phys. Rev. Lett.*, **93**, 114502 (2004).
- 711 [18] M. D. Nornberg, E. J. Spence, R. D. Kendrick, C. M. Jacobson, and C. B. Forest, *Phys. Rev.*
712 *Lett.*, **97**, 044503 (2006).
- 713 [19] F. Petrelis, N. Mordant, and S. Fauve, *Geophys. Astrophys. Fluid Dyn.*, **101**, 289 (2007).
- 714 [20] J. Taylor, *Proc. R. Soc. Lond. A*, **274**, 274 (1963).
- 715 [21] P. Cardin, D. Brito, D. Jault, H.-C. Nataf, and J.-P. Masson, *Magnetohydrodynamics*, **38**,
716 177 (2002).
- 717 [22] D. Jault, *Phys. Earth Planet. Inter.*, **166**, 67 (2008).
- 718 [23] F. H. Busse, *J. Fluid Mech.*, **44**, 441 (1970).
- 719 [24] X. Song and P. Richards, *Nature*, **382**, 221 (1996).
- 720 [25] N. Schaeffer and P. Cardin, *Earth Planet. Sci. Lett.*, **245**, 595 (2006).
- 721 [26] C. Guervilly and P. Cardin, *Geophys. Astrophys. Fluid Dyn.*, **104**, 221 (2010).
- 722 [27] R. Hollerbach, *Proc. R. Soc. Lond. A*, **444**, 333 (1994).
- 723 [28] E. Dormy, P. Cardin, and D. Jault, *Earth Planet. Sci. Lett.*, **160**, 15 (1998).
- 724 [29] R. Hollerbach, E. Canet, and A. Fournier, *Eur. J. Mech. B*, **26**, 729 (2007).

- 725 [30] H.-C. Nataf, T. Alboussière, D. Brito, P. Cardin, N. Gagnière, D. Jault, J.-P. Masson, and
726 D. Schmitt, *Geophys. Astrophys. Fluid Dyn.*, **100**, 281 (2006).
- 727 [31] E. Dormy, D. Jault, and A. M. Soward, *J. Fluid Mech.*, **452**, 263 (2002).
- 728 [32] V. Ferraro, *Mon. Not. Roy. Astron. Soc.*, **97**, 458 (1937).
- 729 [33] H. Spruit, *Astron. Astrophys.*, **349**, 189 (1999).
- 730 [34] C. Charbonnel and S. Talon, *Science*, **309**, 2189 (2005).
- 731 [35] K. MacGregor and P. Charbonneau, *Astrophys. J.*, **519**, 911 (1999).
- 732 [36] L. Mestel and N. Weiss, *Mon. Not. Roy. Astron. Soc.*, **226**, 123 (1987).
- 733 [37] D. Gough, in *Magnetic Coupling between the Interior and Atmosphere of the Sun*, edited by
734 S. Hasan and R. Rutten (Springer, 2010) pp. 68–85.
- 735 [38] J. Aubert, *J. Fluid Mech.*, **542**, 53 (2005).
- 736 [39] H.-C. Nataf, T. Alboussière, D. Brito, P. Cardin, N. Gagnière, D. Jault, and D. Schmitt,
737 *Phys. Earth Planet. Inter.*, **170**, 60 (2008).
- 738 [40] N. Kleeorin, I. Rogachevskii, A. Ruzmaikin, A. M. Soward, and S. Starchenko, *J. Fluid Mech.*,
739 **344**, 213 (1997).
- 740 [41] D. Schmitt, T. Alboussière, D. Brito, P. Cardin, N. Gagnière, D. Jault, and H.-C. Nataf, *J.*
741 *Fluid Mech.*, **604**, 175 (2008).
- 742 [42] Y. Takeda, *Nucl. Technol.*, **79**, 120 (1987).
- 743 [43] D. Brito, H.-C. Nataf, P. Cardin, J. Aubert, and J.-P. Masson, *Exp. Fluids*, **31**, 653 (2001).
- 744 [44] J. Noir, D. Brito, K. Aldridge, and P. Cardin, *Geophys. Res. Lett.*, **28**, 3785 (2001).
- 745 [45] J. Aubert, D. Brito, H.-C. Nataf, P. Cardin, and J.-P. Masson, *Phys. Earth Planet. Inter.*,
746 **128**, 51 (2001).
- 747 [46] N. Gillet, D. Brito, D. Jault, and H.-C. Nataf, *J. Fluid Mech.*, **580**, 83 (2007).
- 748 [47] S. Eckert and G. Gerbeth, *Exp. Fluids*, **32**, 542 (2002).
- 749 [48] D. Lathrop, J. Fineberg, and H. Swinney, *Physical review letters*, **68**, 1515 (1992), ISSN
750 1079-7114.
- 751 [49] K. Mizerski and K. Bajer, *Phys. Earth Planet. Inter.*, **160**, 245 (2007).
- 752 [50] A. Soward and E. Dormy, *J. Fluid Mech.*, **645**, 145 (2010).
- 753 [51] J. Allen, P. Auer, and V. Endean, *Plasma physics*, **18**, 143 (1976).
- 754 [52] P. Garaud, *Mon. Not. Roy. Astron. Soc.*, **329**, 1 (2002).
- 755 [53] J. Aubert, J. Aurnou, and J. Wicht, *Geophys. J. Int.*, **172**, 945 (2008).

- 756 [54] J. Lopez, F. Marques, A. Rubio, and M. Avila, *Phys. Fluids*, **21**, 114107 (2009).
- 757 [55] H.-C. Nataf and N. Gagnière, *C.R. Physique*, **9**, 702 (2008).
- 758 [56] D. Jackson, *Classical Electrodynamics* (John Wiley, New York, 1975).
- 759 [57] R. Holme, *Treatise on Geophysics, Vol. 8 Core Dynamics*, edited by P. Olson and G. Schubert
760 (Elsevier, 2007) Chap. 8.04, pp. 107–129.
- 761 [58] J. J. Love, *Geophys. J. Int.*, **138**, 353 (1999).