



HAL
open science

Direct adaptive suppression of multiple unknown vibrations using an inertial actuator

Ioan Doré Landau, Marouane Alma, John Jairo Martinez Molina, Gabriel Buche

► **To cite this version:**

Ioan Doré Landau, Marouane Alma, John Jairo Martinez Molina, Gabriel Buche. Direct adaptive suppression of multiple unknown vibrations using an inertial actuator. CDC 2010 - 49th IEEE Conference on Decision and Control, Dec 2010, Atlanta, Georgie, United States. pp.1743-1748. hal-00567487

HAL Id: hal-00567487

<https://hal.science/hal-00567487>

Submitted on 21 Feb 2011

HAL is a multi-disciplinary open access archive for the deposit and dissemination of scientific research documents, whether they are published or not. The documents may come from teaching and research institutions in France or abroad, or from public or private research centers.

L'archive ouverte pluridisciplinaire **HAL**, est destinée au dépôt et à la diffusion de documents scientifiques de niveau recherche, publiés ou non, émanant des établissements d'enseignement et de recherche français ou étrangers, des laboratoires publics ou privés.

Direct adaptive suppression of multiple unknown vibrations using an inertial actuator

Ioan Doré Landau, Marouane Alma, John Jairo Martinez, Gabriel Buche

Abstract—An active vibration control system using an inertial actuator for suppression of multiple unknown and/or time-varying vibrations will be presented. The objective is to minimize the residual force by applying an appropriate control effort through the inertial actuator. The system does not use any additional transducer for getting in real time information upon the disturbances.

A direct feedback adaptive regulation scheme for the suppression of multiple unknown and/or time-varying vibrations will be used and evaluated in real time. It uses the internal model principle and the Youla- Kucera parametrization.

Index Terms—direct adaptive regulation, internal model principle, Youla-Kucera parametrization, adaptive disturbance rejection, multiple narrow band disturbances, inertial actuators

I. INTRODUCTION

One of the basic problems in active vibration control is the attenuation of multiple vibrations of unknown and time varying frequencies using only the measurement of the residual force (or acceleration).

Vibrations correspond to disturbances with energy concentrated in a narrow band around unknown and/or time-varying frequencies. From a "signal and system" perspective it is possible to view these disturbances as a white noise or a Dirac impulse passed through a "model of the disturbance". While in general one can assume a certain structure for such "model of disturbance", its parameters are unknown and may be time varying. From a control point of view the objective is the attenuation (rejection) of unknown disturbances without measuring them. Since the model of the disturbances is unknown and time varying, this will require to use an adaptive approach. We have to solve an adaptive regulation problem since the objective is the attenuation of unknown disturbances without measuring them. While the disturbances are narrow band disturbances of unknown and time varying frequency (within a certain frequency region), the dynamic characteristics of the active vibration system itself for a given physical realization are practically constant. The corresponding "control plant model" to be used for control design (and tuning) can be identified from input/output data.

To achieve the rejection of the disturbance (at least asymptotically) without measuring it, an *adaptive feedback solution* can be considered which does not require the use of an additional measurement ([1], [2], [13], [6]). In the present

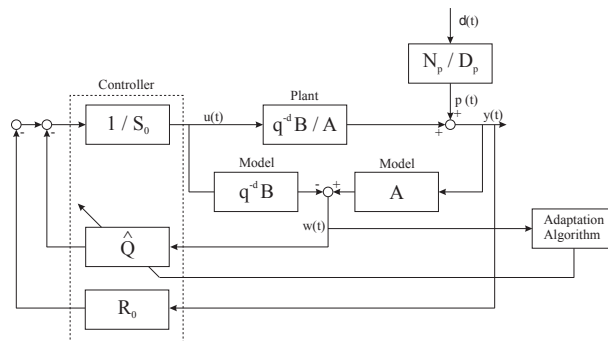

Fig. 1. Direct adaptive regulation scheme for rejection of unknown disturbances

paper we are in the context of an adaptive regulation problem with a known plant model and an unknown disturbance model. This type of problem has been considered in ([5], [1], [2], [19], [17], [8], [10], [13]) among other references.

In order to reject the disturbances in a feedback configuration one has to use the internal model principle. The controller should incorporate the model of the disturbance ([9], [11], [4], [18]). Therefore the rejection of unknown disturbances raises the problem of adapting the internal model of the controller and its re-design in real-time.

One way for solving this problem is to try to estimate in real time the model of the disturbance and re-compute the controller, which will incorporate the estimated model of the disturbance (as a pre-specified element of the controller). This will lead to an indirect adaptive regulation scheme. The time consuming part of this approach is the redesign of the controller at each sampling time. This approach has been investigated in [5], [10], [13].

However, by considering the Youla-Kucera parametrization of the controller (known also as the Q -parametrization), it is possible to insert and adjust the internal model in the controller by adjusting the parameters of the Q polynomial (see figure 1), without recomputing the controller (polynomials R_0 and S_0 in figure 1 remain unchanged). The number of the controller parameters to be directly adapted is roughly equal to the number of parameters of the denominator of the disturbance model.

The novelty of this paper is the presentation of a direct adaptive regulation scheme for building an active vibration control systems using inertial actuators and its application to rejection of multiple unknown vibrations (to the authors' knowledge all the references available deals only with one eventually two vibrations).

I.D. Landau, M. Alma, J.J. Martinez and G. Buche are with control system department of Gipsa-lab, St martin d'hères, 38402 FRANCE ([ioan-dore.landau, marouane.alma, john-jairo.martinez-molina, Gabriel.Buche]@gipsa-lab.grenoble-inp.fr)

The paper is organized as follows. In Section II, the active vibration control system using an inertial actuator on which we shall test the algorithms is presented. Section III is dedicated to a brief review of the plant, disturbance and controller representation, Internal Model Principle and Q-parametrization. Some robustness issues are addressed in section IV. The direct adaptive control schemes for disturbance rejection is presented in section V. Section VI presents the results obtained in real time on the active vibration control system. Some concluding remarks are given in section VII.

II. AN ACTIVE VIBRATION CONTROL SYSTEM USING AN INERTIAL ACTUATOR

The structure of the system used in this paper is presented in figure 2. A general view of the whole system including the testing equipment is shown figure 3. It consists on a passive damper, an inertial actuator, a load, a transducer for the residual force, a controller, a power amplifier and a shaker. The mechanical construction of the load is such that the vibration produced by the shaker, fixed to the ground, are transmitted to the upper side, on top of the passive damper. The inertial actuator will create vibrational forces which can counteract the effect of vibrational disturbances.

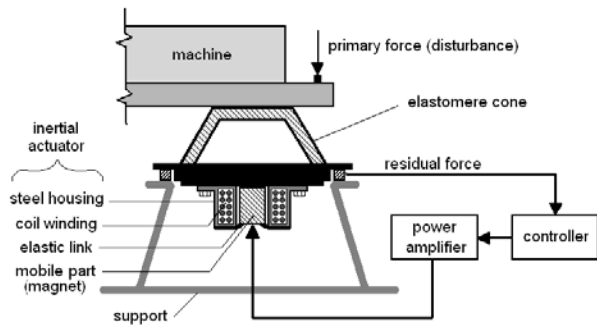

Fig. 2. Active vibration control using an inertial actuator (scheme)

The controller through the power amplifier will generate current in the mobile coil which will produce a movement in order to reduce the residual force. The equivalent control scheme is shown in figure 4. The system input, $u(t)$ is the position of the mobile part (magnet) (see figures 2, 4), the output $y(t)$ is the residual force measured by a force sensor. The transfer function $(q^{-d} \frac{C}{D})$, between the disturbance force, u_p , and the residual force $y(t)$ is called *primary path*. In our case (for testing purposes), the primary force is generated by a shaker driven by a signal delivered by the computer. The plant transfer function $(q^{-d} \frac{B}{A})$ between the input of the inertial actuator, $u(t)$, and the residual force is called *secondary path*. The input of the system being a position and the output a force, the secondary path transfer function has a double differentiator behavior.

The control objective is to attenuate the vibrations transmitted from the machine to the chassis. The system has to be considered as a "black box" and the corresponding

models for control design should be identified. The sampling frequency is 800Hz.



Fig. 3. Active vibration control system (photo)

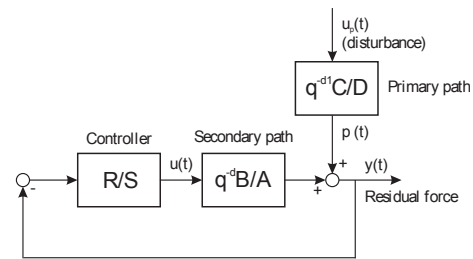

Fig. 4. Block diagram of active vibration suppression systems

III. PLANT REPRESENTATION AND CONTROLLER STRUCTURE

The structure of a linear time invariant discrete time model of the plant- the secondary path- used for controller design is:

$$G(z^{-1}) = \frac{z^{-d} B(z^{-1})}{A(z^{-1})} = \frac{z^{-d-1} B^*(z^{-1})}{A(z^{-1})} \quad (1)$$

with:

d = the plant pure time delay in number of sampling periods

$$A = 1 + a_1 z^{-1} + \dots + a_{n_A} z^{-n_A} ;$$

$$B = b_1 z^{-1} + \dots + b_{n_B} z^{-n_B} = q^{-1} B^* ;$$

where $A(z^{-1})$, $B(z^{-1})$, $B^*(z^{-1})$ are polynomials in the complex variable z^{-1} and n_A , n_B and $n_B - 1$ represent their orders¹. The model of the plant may be obtained by system identification. Details on system identification of the models considered in this paper can be found in [16], [6], [14], [12], [7].

¹The complex variable z^{-1} will be used for characterizing the system's behavior in the frequency domain and the delay operator q^{-1} will be used for describing the system's behavior in the time domain.

Since in this paper we are focused on regulation, the controller to be designed is a RS-type polynomial controller ([15], [16]) - see also figure 4.

The output of the plant $y(t)$ and the input $u(t)$ may be written as:

$$y(t) = \frac{q^{-d}B(q^{-1})}{A(q^{-1})}u(t) + p(t) \quad (2)$$

$$S(q^{-1})u(t) = -R(q^{-1})y(t) \quad (3)$$

where q^{-1} is the delay (shift) operator ($x(t) = q^{-1}x(t+1)$) and $p(t)$ is the resulting additive disturbance on the output of the system. $R(z^{-1})$ and $S(z^{-1})$ are polynomials in z^{-1} having the orders n_R and n_S , respectively, with the following expressions:

$$R(z^{-1}) = r_0 + r_1z^{-1} + \dots + r_{n_R}z^{-n_R} = R'(z^{-1})H_R(z^{-1}) \quad (4)$$

$$S(z^{-1}) = 1 + s_1z^{-1} + \dots + s_{n_S}z^{-n_S} = S'(z^{-1})H_S(z^{-1}) \quad (5)$$

where H_R and H_S are pre-specified parts of the controller (used for example to incorporate the internal model of a disturbance or to open the loop at certain frequencies).

We define the following sensitivity functions:

- Output sensitivity function (the transfer function between the disturbance $p(t)$ and the output of the system $y(t)$):

$$S_{yp}(z^{-1}) = \frac{A(z^{-1})S(z^{-1})}{P(z^{-1})} \quad (6)$$

- Input sensitivity function (the transfer function between the disturbance $p(t)$ and the input of the system $u(t)$):

$$S_{up}(z^{-1}) = -\frac{A(z^{-1})R(z^{-1})}{P(z^{-1})} \quad (7)$$

where

$$\begin{aligned} P(z^{-1}) &= A(z^{-1})S(z^{-1}) + z^{-d}B(z^{-1})R(z^{-1}) \\ &= A(z^{-1})S'(z^{-1})H_S(z^{-1}) + z^{-d}B(z^{-1})R'(z^{-1})H_R(z^{-1}) \end{aligned} \quad (8)$$

defines the poles of the closed loop (roots of $P(z^{-1})$).

In pole placement design, the polynomial $P(z^{-1})$ specifies the desired closed loop poles and the controller polynomials $R(z^{-1})$ and $S(z^{-1})$ are minimal degree solutions of (8) where the degrees of P , R and S are given by: $n_P \leq n_A + n_B + d - 1$, $n_S = n_B + d - 1$ and $n_R = n_A - 1$.

Using the equations (2) and (3), one can write the output of the system as:

$$y(t) = \frac{A(q^{-1})S(q^{-1})}{P(q^{-1})}p(t) = S_{yp}(q^{-1})p(t) \quad (9)$$

Suppose that $p(t)$ is a deterministic disturbance, so it can be written as

$$p(t) = \frac{N_p(q^{-1})}{D_p(q^{-1})}\delta(t) \quad (10)$$

where $\delta(t)$ is a Dirac impulse and $N_p(z^{-1})$, $D_p(z^{-1})$ are coprime polynomials in z^{-1} , of degrees n_{N_p} and n_{D_p} , respectively. In the case of stationary disturbances the roots of $D_p(z^{-1})$ are on the unit circle. The energy of the disturbance is essentially represented by D_p . The contribution of the terms of N_p is weak compared to the effect of D_p , so one can neglect the effect of N_p .

Internal Model Principle: The effect of the disturbance given in (10) upon the output:

$$y(t) = \frac{A(q^{-1})S(q^{-1})}{P(q^{-1})} \cdot \frac{N_p(q^{-1})}{D_p(q^{-1})}\delta(t), \quad (11)$$

where $D_p(z^{-1})$ is a polynomial with roots on the unit circle and $P(z^{-1})$ is an asymptotically stable polynomial, converges asymptotically towards zero if and only if the polynomial $S(z^{-1})$ in the RS controller has the form:

$$S(z^{-1}) = D_p(z^{-1})S'(z^{-1}). \quad (12)$$

In other terms, the pre-specified part of $S(z^{-1})$ should be chosen as $H_S(z^{-1}) = D_p(z^{-1})$ and the controller is computed using (8), where P , D_p , A , B , H_R and d are given².

Using the Youla-Kucera parametrization (Q-parametrization) of all stable controllers ([3], [18]), the controller polynomials $R(z^{-1})$ and $S(z^{-1})$ get the form:

$$R(z^{-1}) = R_0(z^{-1}) + A(z^{-1})Q(z^{-1}); \quad (13)$$

$$S(z^{-1}) = S_0(z^{-1}) - z^{-d}B(z^{-1})Q(z^{-1}). \quad (14)$$

The (central) controller (R_0, S_0) can be computed by poles placement (but any other design technique can be used). Given the plant model (A, B, d) and the desired closed-loop poles specified by the roots of P one has to solve:

$$P(z^{-1}) = A(z^{-1})S_0(z^{-1}) + z^{-d}B(z^{-1})R_0(z^{-1}). \quad (15)$$

Equations (13) and (14) characterize the set of all stabilizable controllers assigning the closed loop poles as defined by $P(z^{-1})$. For the purpose of this paper $Q(z^{-1})$ is considered to be a polynomial of the form:

$$Q(z^{-1}) = q_0 + q_1z^{-1} + \dots + q_{n_Q}z^{-n_Q}. \quad (16)$$

To compute $Q(z^{-1})$ in order that the polynomial $S(z^{-1})$ given by (14) incorporates the internal model of the disturbance (12) one has to solve the diophantine equation:

$$S'(z^{-1})D_p(z^{-1}) + z^{-d}B(z^{-1})Q(z^{-1}) = S_0(z^{-1}), \quad (17)$$

where $D_p(z^{-1})$, d , $B(z^{-1})$ and $S_0(z^{-1})$ are known and $S'(z^{-1})$ and $Q(z^{-1})$ are unknown. Equation (17) has a unique solution for $S'(z^{-1})$ and $Q(z^{-1})$ with: $n_{S_0} \leq n_{D_p} + n_B + d - 1$, $n_{S'} = n_B + d - 1$, $n_Q = n_{D_p} - 1$. One sees that the order n_Q of the polynomial Q depends upon the structure of the disturbance model.

IV. ROBUSTNESS CONSIDERATIONS

As it is well known, the introduction of the internal model for the perfect rejection of the disturbance (asymptotically) may have as effect to raise the maximum value of the modulus of the output sensitivity function S_{yp} . This may lead to unacceptable values for the modulus margin ($|S_{yp}(e^{-j\omega})|_{max}^{-1}$) and the delay margins if the controller design is not appropriately done (see [16]). As a consequence, a robust control design should be considered assuming that the model of the disturbance and its domain of variations in the frequency

²Of course it is assumed that D_p and B do not have common factors.

domain are known. The objective is that for all situations an acceptable modulus margin and delay margin are obtained.

Furthermore, at the frequencies where perfect rejection of the disturbance is achieved one has $S_{yp}(e^{-j\omega}) = 0$ and

$$|S_{up}(e^{-j\omega})| = \left| \frac{A(e^{-j\omega})}{B(e^{-j\omega})} \right|. \quad (18)$$

Equation (18) corresponds to the inverse of the gain of the system to be controlled. The implication of equation (18) is that cancellation (or in general an important attenuation) of disturbances on the output should be done only in frequency regions where the system gain is large enough. If the gain of the controlled system is too low, $|S_{up}|$ will be large at these frequencies. Therefore, the robustness vs additive plant model uncertainties will be reduced and the stress on the actuator will become important [16].

V. DIRECT ADAPTIVE CONTROL FOR DISTURBANCE ATTENUATION

The objective is to find an estimation algorithm which will directly estimate the parameters of the internal model in the controller in the presence of an unknown disturbance (but of known structure) without modifying the closed loop poles. Clearly, the Q-parametrization is a potential option since modifications of the Q polynomial will not affect the closed loop poles. In order to build an estimation algorithm it is necessary to define an *error equation* which will reflect the difference between the optimal Q polynomial and its current value.

This idea has been used in [18], [19], [1], [2], [13]. Using the Q-parametrization, the output of the system in the presence of a disturbance can be expressed as:

$$\begin{aligned} y(t) &= \frac{A(q^{-1})[S_0(q^{-1}) - q^{-d}B(q^{-1})Q(q^{-1})]}{P(q^{-1})} \cdot \frac{N_p(q^{-1})}{D_p(q^{-1})} \delta(t) \\ &= \frac{S_0(q^{-1}) - q^{-d}B(q^{-1})Q(q^{-1})}{P(q^{-1})} w(t) \end{aligned} \quad (19)$$

where $w(t)$ is given by (see also figure 1):

$$\begin{aligned} w(t) &= \frac{A(q^{-1})N_p(q^{-1})}{D_p(q^{-1})} \delta(t) \\ &= A(q^{-1})y(t) - q^{-d}B(q^{-1})u(t) \end{aligned} \quad (20)$$

In the time domain, the internal model principle can be interpreted as finding Q such that asymptotically $y(t)$ becomes zero. Assume that one has an estimation of $Q(q^{-1})$ at instant t , denoted $\hat{Q}(t, q^{-1})$. Define $\varepsilon^0(t+1)$ as the value of $y(t+1)$ obtained with $\hat{Q}(t, q^{-1})$.

Using (19) one gets:

$$\varepsilon^0(t+1) = \frac{S_0(q^{-1})}{P(q^{-1})} w(t+1) - \frac{q^{-d}B^*(q^{-1})}{P(q^{-1})} \hat{Q}(t, q^{-1}) w(t) \quad (21)$$

One can define now the *a posteriori* error (using $\hat{Q}(t+1, q^{-1})$) as:

$$\varepsilon(t+1) = \frac{S_0(q^{-1})}{P(q^{-1})} w(t+1) - \frac{q^{-d}B^*(q^{-1})}{P(q^{-1})} \hat{Q}(t+1, q^{-1}) w(t) \quad (22)$$

Replacing $S_0(q^{-1})$ from the last equation by (17) one obtains:

$$\varepsilon(t+1) = [Q(q^{-1}) - \hat{Q}(t+1, q^{-1})] \frac{q^{-d}B^*(q^{-1})}{P(q^{-1})} w(t) + v(t+1), \quad (23)$$

where

$$v(t) = \frac{S'(q^{-1})D_p(q^{-1})}{P(q^{-1})} w(t) = \frac{S'(q^{-1})A(q^{-1})N_p(q^{-1})}{P(q^{-1})} \delta(t)$$

is a signal which tends asymptotically towards zero.

Define the estimated polynomial $\hat{Q}(t, q^{-1})$ as: $\hat{Q}(t, q^{-1}) = \hat{q}_0(t) + \hat{q}_1(t)q^{-1} + \dots + \hat{q}_{n_Q}(t)q^{-n_Q}$ and the associated estimated parameter vector: $\hat{\theta}^T(t) = [\hat{q}_0(t) \hat{q}_1(t) \dots \hat{q}_{n_Q}(t)]^T$. Define the fixed parameter vector corresponding to the optimal value of the polynomial Q as: $\theta = [q_0 q_1 \dots q_{n_Q}]^T$.

Denote:

$$w_2(t) = \frac{q^{-d}B^*(q^{-1})}{P(q^{-1})} w(t) \quad (24)$$

and define the following observation vector:

$$\phi^T(t) = [w_2(t) \quad w_2(t-1) \quad \dots \quad w_2(t-n_Q)]. \quad (25)$$

Equation (23) becomes

$$\varepsilon(t+1) = [\theta^T - \hat{\theta}^T(t+1)]\phi(t) + v(t+1). \quad (26)$$

One can remark that $\varepsilon(t+1)$ corresponds to an adaptation error ([15]).

From equation (21) one obtains the *a priori* adaptation error:

$$\varepsilon^0(t+1) = w_1(t+1) - \hat{\theta}^T(t)\phi(t),$$

with

$$w_1(t+1) = \frac{S_0(q^{-1})}{P(q^{-1})} w(t+1); \quad (27)$$

$$w_2(t) = \frac{q^{-d}B^*(q^{-1})}{P(q^{-1})} w(t); \quad (28)$$

$$w(t+1) = A(q^{-1})y(t+1) - q^{-d}B^*(q^{-1})u(t), \quad (29)$$

where $B(q^{-1})u(t+1) = B^*(q^{-1})u(t)$.

The *a posteriori* adaptation error is obtained from (22):

$$\varepsilon(t+1) = w_1(t+1) - \hat{\theta}^T(t+1)\phi(t).$$

For the estimation of the parameters of $\hat{Q}(t, q^{-1})$ the following parameter adaptation algorithm is used ([15]):

$$\hat{\theta}(t+1) = \hat{\theta}(t) + F(t)\phi(t)\varepsilon(t+1); \quad (30)$$

$$\varepsilon(t+1) = \frac{\varepsilon^0(t+1)}{1 + \phi^T(t)F(t)\phi(t)}; \quad (31)$$

$$\varepsilon^0(t+1) = w_1(t+1) - \hat{\theta}^T(t)\phi(t); \quad (32)$$

$$F(t+1) = \frac{1}{\lambda_1(t)} \left[F(t) - \frac{F(t)\phi(t)\phi^T(t)F(t)}{\lambda_1(t) + \phi^T(t)F(t)\phi(t)} \right] \quad (33)$$

$$1 \geq \lambda_1(t) > 0; 0 \leq \lambda_2(t) < 2 \quad (34)$$

where $\lambda_1(t), \lambda_2(t)$ allow to obtain various profiles for the evolution of the adaption gain $F(t)$ (for details see [15], [16]).

In the *adaptive* operation (the adaptation is performed continuously and the controller is updated at each sampling) one uses in general an adaptation gain updating with variable forgetting factor $\lambda_1(t)$ (the forgetting factor tends towards 1), combined with a *constant trace* adaption gain. For details see [16], [15].

For a stability analysis of this scheme see [13].

VI. ADAPTIVE REJECTION OF MULTIPLE NARROW BAND DISTURBANCES ON AN ACTIVE VIBRATION CONTROL SYSTEM USING AN INERTIAL ACTUATOR

A. Plant identification and central controller design

The primary path (between the shaker excitation and the residual force) has been identified in open loop operation. The excitation signal was a PRBS generated with a shift register with $N = 10$ and a frequency divider of $p = 4$ [16]. The estimated orders of the model are: $n_C = 10$, $n_D = 8$, $d_1 = 0$. The frequency characteristic of the primary path is shown in figure 5 (dashed).

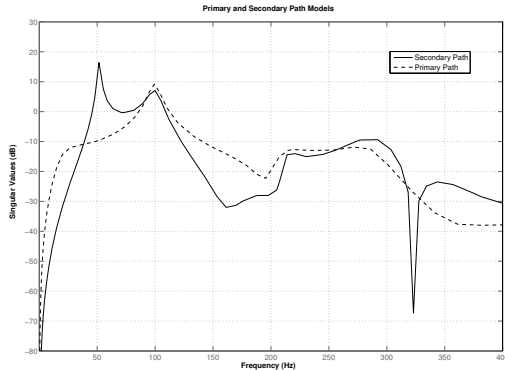

Fig. 5. Frequency characteristics of the primary and secondary paths (inertial actuator)

The frequency characteristic of the identified model of the secondary path is shown in figure 5 (continue). Same excitation signal as for the primary path has been used. The estimated orders of the model are: $n_B = 13$, $n_A = 11$, $d = 0$.

The central controller (without internal model) has been designed using pole placement with sensitivity shaping [16]. The closed loop poles are the complex poles of the open loop model but with a higher damping plus auxiliary high frequency aperiodic poles introduced for robustness reasons. A prespecified part $H_R = 1 + q^{-1}$ has been introduced in order to open the loop at $0.5f_s$.

The frequency domain in which vibrations will be attenuated is between 45 and 105Hz.

B. The case of two simultaneous narrow band disturbances

Two simultaneous time varying frequency sinusoids will be considered as disturbances. In this case one should take $n_{D_p} = 4$ and $n_Q = n_{D_p} - 1 = 3$.

Time domain results obtained with direct adaptation scheme in "adaptive" operation regime are shown in Figure 6. The disturbances are applied at 1s (the loop has already been closed) and step changes of their frequencies occur every 3s. The convergence of the output requires less than 0.7s in the worst case.

Figure 7 shows the corresponding evolution of the parameters of the polynomial Q .

Figure 8 shows the spectral densities of the residual

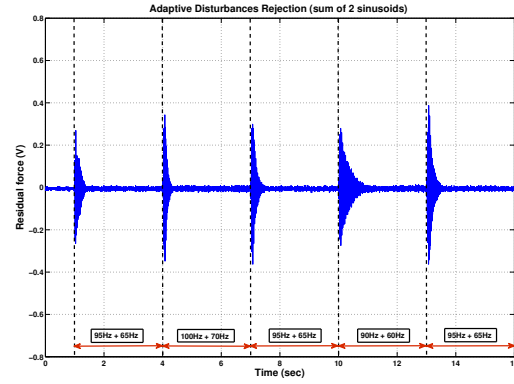

Fig. 6. Time domain results with direct adaptation method for simultaneous frequency step changes of two sinusoidal disturbances

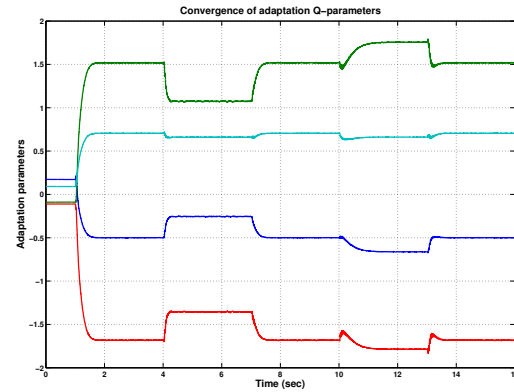

Fig. 7. Evolution of the parameters of the polynomial Q during adaptation

force obtained in open loop and in closed loop using the direct adaptation scheme (after the adaptation algorithm has converged). The results are given for the simultaneous applications of two sinusoidal disturbances (65Hz and 95Hz). One can remark a strong attenuation of the disturbances (larger than 45dB).

There is a permanent measurement noise at 50Hz (the power network), which is however not amplified in closed loop.

The variance of the residual force in open loop is: $\text{var}(y_{ol}) = 1.087510^{-1}$. In closed loop (after the adaptation algorithm has converged), the variance is: $\text{var}(y_{cl}) = 5.6428 \cdot 10^{-5}$. This corresponds to a global attenuation of 66dB.

C. The case of three simultaneous narrow band disturbances

Time domain results in "adaptive" operation regime are presented in figure 9. The same protocol for disturbances application, as in the previous case, has been considered (disturbances are applied at 1s and step changes of their frequencies occur every 3s). The convergence of the output requires 0.8s in the worst case.

Figure 10 shows the spectral densities of the residual force obtained in open loop and in closed loop using the direct adaptation scheme (after the adaptation algorithm has converged). The results are given for the simultane-

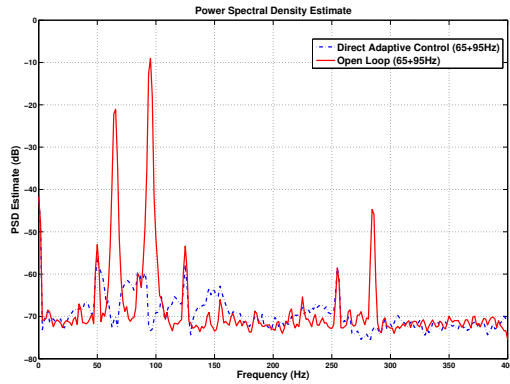

Fig. 8. Spectral densities of the residual force in open an in closed loop, with the direct adaption method in adaptive operation

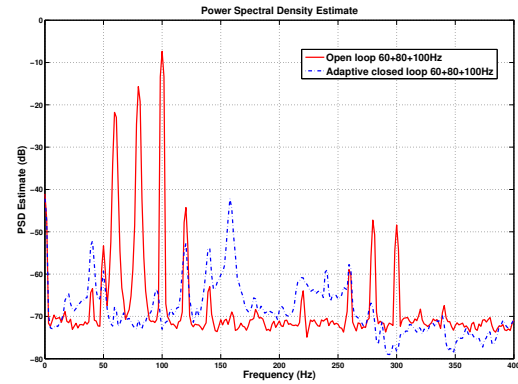

Fig. 10. Spectral densities of the residual force in open an in closed loop, with the direct adaption method in adaptive operation

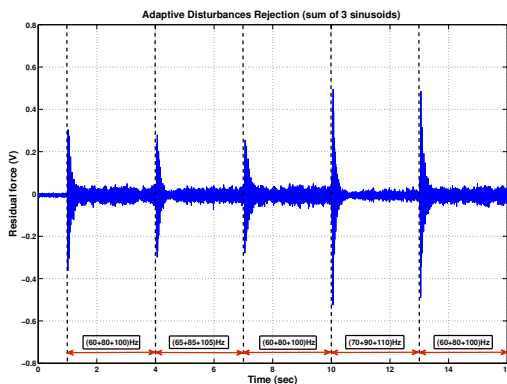

Fig. 9. Time domain results with direct adaptation method for simultaneous frequency step changes of three sinusoidal disturbances

ous applications of three sinusoidal disturbances (60Hz, 80Hz and 100Hz). One can remark a strong attenuation of the disturbances (larger than 45dB). In closed loop, an acceptable amplification of some frequencies outside the attenuation band is observed. An improved design of the central controller may assure an improved distribution of this amplification in the frequency domain (lower maximum value). The measurement noise at 50Hz is not amplified in closed loop.

The variance of the residual force in open loop is: $var(y_{ol}) = 1.0792 \cdot 10^{-1}$. In closed loop (after the adaptation algorithm has converged), the variance is: $var(y_{cl}) = 6.0370 \cdot 10^{-4}$. This corresponds to a global attenuation of 45dB.

VII. CONCLUSIONS

The results obtained in real time on an active vibration control system (using an inertial actuator) illustrate the potential of the adaptive approach proposed for rejection of unknown time varying narrow band disturbances.

REFERENCES

[1] F. Ben Amara, P.T. Kabamba, and A.G. Ulsoy. Adaptive sinusoidal disturbance rejection in linear discrete-time systems - Part I: Theory. *Journal of Dynamic Systems Measurement and Control*, 121:648–654, 1999.

[2] F. Ben Amara, P.T. Kabamba, and A.G. Ulsoy. Adaptive sinusoidal disturbance rejection in linear discrete-time systems - Part II: Experiments. *Journal of Dynamic Systems Measurement and Control*, 121:655–659, 1999.

[3] B.D.O. Anderson. From Youla-Kucera to identification, adaptive and nonlinear control. *Automatica*, 34:1485–1506, 1998.

[4] G. Bengtsson. Output regulation and internal models - a frequency domain approach. *Automatica*, 13:333–345, 1977.

[5] M. Bodson and S.C. Douglas. Adaptive algorithms for the rejection of sinusoidal disturbances with unknown frequency. *Automatica*, 33:2213–2221, 1997.

[6] A. Constantinescu. *Comande robuste et adaptative d'une suspension active*. Thèse de doctorat, Institut National Polytechnique de Grenoble, décembre 2001.

[7] A. Constantinescu and I.D. Landau. Direct controller order reduction by identification in closed loop applied to a benchmark problem. *European Journal of Control*, 9(1), 2003.

[8] Z. Ding. Global stabilization and disturbance suppression of a class of nonlinear systems with uncertain internal model. *Automatica*, 39:471–479, 2003.

[9] B.A. Francis and W.M. Wonham. The internal model principle of control theory. *Automatica*, 12:457–465, 1976.

[10] T. Gouraud, M. Gugliemi, and F. Auger. Design of robust and frequency adaptive controllers for harmonic disturbance rejection in a single-phase power network. *Proceedings of the European Control Conference, Bruxelles, 1997*.

[11] C.D. Johnson. Theory of disturbance-accomodating controllers. In *Control and Dynamical Systems* (C. T. Leondes, Ed.), 1976. Vol. 12, pp. 387–489.

[12] I.D. Landau, A. Constantinescu, P. Loubat, D. Rey, and A. Franco. A methodology for the design of feedback active vibration control systems. *Proceedings of the European Control Conference 2001*, 2001. Porto, Portugal.

[13] I.D. Landau, A. Constantinescu, and D. Rey. Adaptive narrow band disturbance rejection applied to an active suspension - an internal model principle approach. *Automatica*, 41(4):563–574, 2005.

[14] I.D. Landau, A. Karimi, and A. Constantinescu. Direct controller order reduction by identification in closed loop. *Automatica*, (37):1689–1702, 2001.

[15] I.D. Landau, R. Lozano, and M. M'Saad. *Adaptive control*. Springer, London, 1997.

[16] I.D. Landau and G. Zito. *Digital Control Systems - Design, Identification and Implementation*. Springer, London, 2005.

[17] R. Marino, G.L. Santosuoso, and P. Tomei. Robust adaptive compensation of biased sinusoidal disturbances with unknown frequency. *Automatica*, 39:1755–1761, 2003.

[18] Y.Z. Tsytkin. Stochastic discrete systems with internal models. *Journal of Automation and Information Sciences*, 29(4&5):156–161, 1997.

[19] S. Valentinotti. *Adaptive Rejection of Unstable Disturbances: Application to a Fed-Batch Fermentation*. Thèse de doctorat, École Polytechnique Fédérale de Lausanne, April 2001.