



**HAL**  
open science

# Morphology of the gastrointestinal tract in primates : Comparisons with other mammals in relation to diet

David J Chivers, Claude Marcel Hladik

► **To cite this version:**

David J Chivers, Claude Marcel Hladik. Morphology of the gastrointestinal tract in primates : Comparisons with other mammals in relation to diet. *Journal of Morphology*, 1980, 166, pp.337-386. hal-00561758

**HAL Id: hal-00561758**

**<https://hal.science/hal-00561758>**

Submitted on 16 Mar 2013

**HAL** is a multi-disciplinary open access archive for the deposit and dissemination of scientific research documents, whether they are published or not. The documents may come from teaching and research institutions in France or abroad, or from public or private research centers.

L'archive ouverte pluridisciplinaire **HAL**, est destinée au dépôt et à la diffusion de documents scientifiques de niveau recherche, publiés ou non, émanant des établissements d'enseignement et de recherche français ou étrangers, des laboratoires publics ou privés.

CHIVERS D.J. & HLADIK C.M. (1980) — Morphology of the gastrointestinal tract in primates : Comparisons with other mammals in relation to diet. *Journal of Morphology*, 166 : 337-386.



## Morphology of the Gastrointestinal Tract in Primates: Comparisons With Other Mammals in Relation to Diet

DAVID J. CHIVERS AND C.M. HLADIK  
Sub-Department of Veterinary Anatomy, University of Cambridge, Tennis Court Road,  
Cambridge, England, and C.N.R.S., Museum National d'Histoire Naturelle, Brunoy,  
France

**ABSTRACT** Three categories of dietary adaptation are recognized—*faunivory*, *frugivory*, and *folivory*—according to the distinctive structural and biochemical features of animal matter, fruit, and leaves respectively, and the predominance of only one in the diets of most species.

Mammals subsisting mainly on animal matter have a simple stomach and colon and a long small intestine, whereas folivorous species have a complex stomach and/or an enlarged caecum and colon; mammals eating mostly fruit have an intermediate morphology, according to the nature of the fruit and their tendency to supplement this diet with either animal matter or leaves. The frugivorous group are mostly primates: 50 of the 78 mammalian species, and 117 of the 180 individuals included in this analysis are primates.

*Coefficients of gut differentiation*, the ratio of stomach and large intestine to small intestine (by area, weight, and volume), are low in faunivores and high in folivores; the continuous spread of coefficients reflects the different degrees of adaptation to these two dietary extremes.

Interspecific comparisons are developed by allowing for allometric factors. In faunivores, in which fermentation is minimal, the volume of stomach and large intestine is related to actual body size, whereas these chambers are more voluminous in larger frugivores and mid-gut fermenting folivores; fore-gut fermenters show a marked decrease in capacity with increasing body size. Surface areas for absorption are related to metabolic body size, directly so in frugivores; area for absorption is relatively less in larger faunivores and more in larger folivores, especially those with large stomachs.

*Indices of gut specialization* are derived from these regressions by nonlinear transformation, with references to the main functional features of capacity for fermentation and surface area for absorption.

These are directly comparable with the *dietary index*, derived from quantitative feeding data displayed on a three-dimensional graph, with all species within a crescentic path from 100% faunivory through 55–80% frugivory to 100% folivory, perhaps illustrating, at least for primates, the evolutionary path from primitive insectivorous forms through three major ecological grades.

Recent field studies of primates have produced major advances in our understanding of their feeding behaviour and diet (Clutton-Brock, '77; Chivers and Herbert, '78; Hladik, '75). The introduction of quantitative assessments of diet in these field studies allows precise comparisons between food intake and the morphology of the gastro-intestinal tract.

Detailed descriptions of gut morphology in mammals (Mitchell, '05; Bolk et al., '39;

Grassé, '55; Hill, '58) have also lacked effective quantification. The first quantitative effort at comparing gut morphology with diet (Cuvier, 1805) produced no obvious correlations. Magnan ('12), however, working with areas rather than lengths, demonstrated a correlation between structure and diet (in general terms), but data are not presented so that his conclusions can be verified. Preliminary efforts at a more critical analysis (Fooden, '64; Hladik,

'67) showed interesting relationships among primates, but data on diet were still inadequate.

Our aims in this paper are 1) to describe various features of gut morphology with greater precision and quantification, 2) to present data from our field and laboratory studies, 3) to account for allometric factors in the discussion of interspecific differences, and 4) to compare these data on morphology with what is now known about the feeding ecology of the species concerned.

The combination of data on primates with those on domestic and other mammals is useful, because it allows a group of closely-related species with considerable dietary flexibility to be contrasted with others which have become highly specialized for markedly different diets. While the structure of the gastro-intestinal tract is fairly homogeneous among the different orders of mammals, there have been parallel developments of different parts of the gut in various evolutionary lineages. These reflect adaptations to different foods, which can be classified into three major groups, according to structure and biochemical composition, and the resulting digestive requirements:

1) "Animal matter," including invertebrates, fish, and other small vertebrates from the secondary production of the ecosystem, which provide sources of protein and fat that are easily digested and, therefore, require a relatively short and simple gut.

2) "Fruits," including unripe (e.g., flowers) and ripe (fleshy) parts, seeds, and tubers—mostly the reproductive parts of plants—which are foods containing short-chain sugars that are hydrolyzed rapidly in tracts of large intestinal area for rapid absorption and immediate use.

3) "Leaves," including young and mature leaves, grasses, stems, as well as barks and gums—the vegetative parts of plants—which are foods usually containing protein and long-chain sugars that require fermentation in an enlarged stomach or large intestine.

According to the predominant items consumed, three categories of dietary adaptation may be recognized, and in this paper they are referred to hereafter as *faunivore*, *frugivore*, and *folivore* respectively (recognition of insectivore, carnivore, and herbivore, with their taxonomic and other connotations, contributes little to this analysis). These categories represent a gradation, for a generalized mammal, from foods that are relatively difficult to collect but easy to digest (prey), through those

available in limited quantity (fruit), to those that are widely abundant but relatively difficult to digest (leaves). Hence the need for marked differentiation of feeding strategy and gut morphology. A classification in terms of three dietary grades (Hladik, '78a), with appropriate subdivisions, allows greater flexibility, and seems to represent successive evolutionary stages of greater admixture of the different types of food.

#### COMPARATIVE ANATOMY OF THE GASTRO-INTESTINAL TRACT

The structure of the wall of the gastro-intestinal tract follows a pattern common to all vertebrates: the inner lining of mucous membrane is separated by connective tissue from an outer cylinder of at least two layers of muscle. Variation in histological structure effects divisions into *stomach*, *small intestine* (duodenum, jejunum, ileum), and *large intestine* (caecum and colon). Brief reference will be made to various configurations of the mucosa and underlying connective tissue, which apparently assist digestion mechanically, by mixing or slowing the passage of food or by increasing the surface area for digestion and absorption, e.g., papillae, rugae (folds), haustrae (sacculations), villi.

In this section we shall try to identify those structures relating to each of the three main dietary adaptations by supplementing previous knowledge with new observations. The latter are made from relaxed guts immersed in water and positioned to show the main features clearly; a complete reconstruction, impossible by photograph, is achieved by moving parts of the tract while drawing, and adjusting the dimensions of each region after dissection and measurement.

#### Faunivores

The basic pattern of gut structure among faunivores consists of a simple globular stomach, tortuous small intestine, short conical caecum, and simple smooth-walled colon. This pattern is exhibited by primates feeding mainly on invertebrates, such as *Arctocebus* (Fig. 1), *Loris*, and *Tarsius*. In other mammals there may be structural specialization in one direction or another. The smallest mammalian gut known is found in the insectivorous bat, *Rhinopoma*; its tract is only four-fifths of body length (Grassé, '55). Simplification of the gut is extreme in haemophagous bats, such as *Desmodus*, with the stomach as a blind-ending tube, a very short colon, and no caecum. Such

reductions are clearly specializations, rather than representing the primitive condition.

Specializations of faunivores may also involve the stomach. Some ant-eating edentates also lack a caecum and the gut is only seven times body length, but the stomach contains

a "muscular tooth" compensating for the lack of oral teeth (Grassé, '55). A similar muscular specialization is found in pholidotes, such as the termite-eating pangolin, *Manis* (Fig. 1), supplemented by a keratinized area in the pylorus and by the presence of small stones.

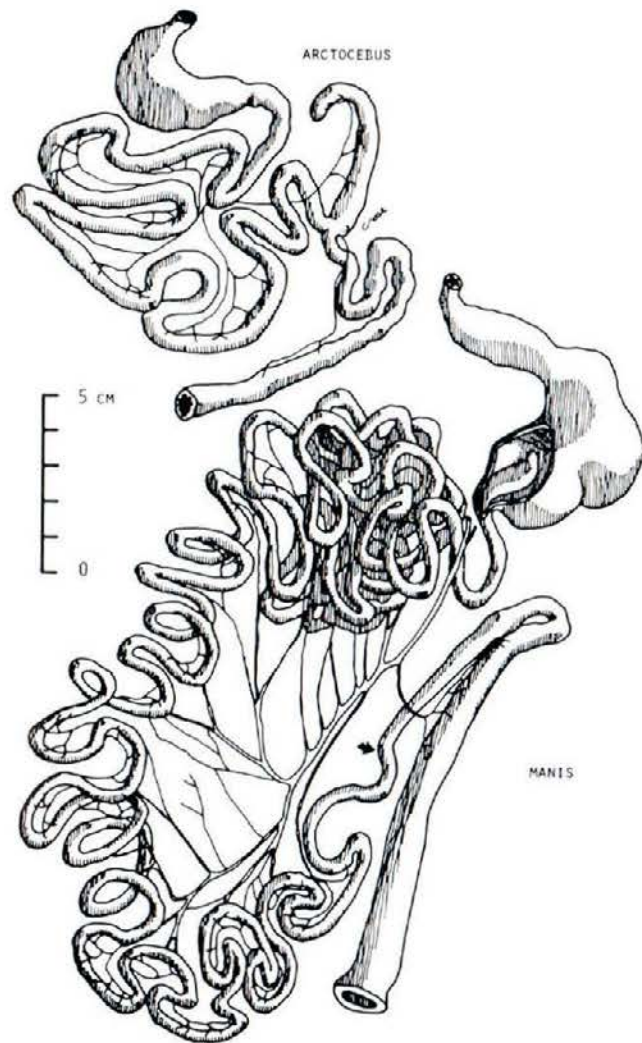

Fig. 1. Gastro-intestinal tracts of faunivores, drawn by C.M.H., with accurate scaling of proportions, main blood vessels to show the disposition of mesenteries, and conventional shading of the different morphological features. The angwantibo, *Arctocebus calabarensis* (specimen FC, see table 5) is one of the most unspecialized in terms of morphology. The pangolin, *Manis gigantea* (specimen MR, juvenile) is presented below with an open stomach to show the muscular "tooth;" the arrow marks the junction of ileum and colon, determined from microscopic examination of the mucosal wall; the extreme length of the small intestine did not allow it to be drawn completely unfolded, as in other drawings.

In cetaceans the stomach has three main compartments (Harrison et al., '70). The first and largest is covered by folds of thick, keratinized epithelium, the second by spirally arranged folds of thick, glandular epithelium (making a direct channel along the lesser curvature), and the third, tubular compartment has a simple pyloric mucosa and strong sphincters at both ends, e.g., the porpoise *Phocaena* (Fig. 2). The small intestine, starting from a dilated duodenum, is very long (about 1500 cm); there is no caecum and a very short colon (only 10 cm, identified under the dissecting microscope by the abrupt transition from villi to crypts).

In the Insectivora the simple stomach is followed by a very short small intestine and, usually, no caecum—as illustrated by *Potomogale* (Fig. 3), which is adapted for feeding on freshwater fish and crustaceans. In *Sorex* the tract is only 2.6 times body length, and some faeces are reingested to permit a second opportunity for digestion. This phenomenon of reflection (Crowcroft, '52) helps to explain the reduction in gut size as a physiological/behavioral specialization. In one species of *Tenrec*, which eats foods other than insects, the tract may be seven times body length. Tree shrews, *Tupaia*, which also supplement their invertebrate diet with fruit, have a slightly larger colon than other insectivores and a small caecum (Grassé, '55). Some rodents subsist on a diet composed entirely of insects or other animal prey. In the African murid *Lophuromys*, for example, specialization to such a diet includes a change in the distribution of gastric glands (Genest-Villard, 1968).

Other mammals, such as some feeding on vertebrates, show no obvious specialization. In fissipedes, for example, the stomach is simple, the small intestine four to six times body length, the caecum small or absent, and the colon reduced, as shown in the Viverridae by the African linsang *Poiana* (Fig. 3) and the mongoose *Atilax*, and in the Felidae by the golden cat *Profelis* (Fig. 4). The shape, internal features, and relative sizes of fundus and pylorus vary slightly among such mammals, as described by Ellenberger and Baum ('21) and illustrated here by the domestic dog, *Canis* (Fig. 5).

#### Frugivores

This group contains most primates, but none of them subsists entirely on fruit. All frugivores supplement their diets with varying amounts of insects and/or leaves, but have no

distinctive structural specialization in the gut, although its morphology may show considerable variation between species.

Some Carnivora also have this mixed diet, but retain the structural features of faunivores, e.g., the palm civet *Nandinia* feeds heavily on fruit (Charles-Dominique, '78), but has no caecum and a reduced colon (Fig. 6).

Myoxid rodents also have no caecum (Grassé, '55), and their predation on birds, as a supplement to seeds and fruit, places them on the border between faunivores and frugivores. In the stomachs of cricetine rodents, the fundus and enlarged cardiac gland region vary in their dimensions, separated by a fold of varying shape (Carleton, '73). In frugivorous bats the stomach is relatively complex, with a distinct cardiac region, a long pyloric diverticulum folded back on itself, and a lateral "caecum"; the true caecum is present in several genera (Grassé, '55).

Among artiodactyls, the pigs have a stomach that is clearly divided into zones, and in some cases into compartments; they have an especially long small intestine, a large caecum, and a relatively complex colon, so that the whole tract is about 20 times body length. These elaborations relate to the inclusion of roots and other vegetative parts of plants in their diet.

Gut structure is more homogeneous among frugivorous primates (Figs. 7, 8, 9). The stomach is essentially simple and globular in structure (Hill, '58). Marmosets show some elongation of the fundus, whereas those of cebids are more specialized with a globular fundus, conical body, and cylindrical pylorus. *Alouatta*, which also eats many leaves (40% of diet by weight, Hladik and Hladik, '69), shows the greatest complexity, with a capacious globular sac, narrowing towards the bent tubular pylorus, which is guarded by strong pillars; rugae radiate from the cardia and run longitudinally within the body. *Ateles*, which is one of the most frugivorous and swallows many stones, has an enlarged J-shaped stomach. Old World primates, other than colobine monkeys, have a single smooth-walled sac; among the apes it is more globular and man-like in gibbons, even more globular in gorillas, and more elongated in chimpanzees and orangutans (Hill, '58).

The duodenum is commonly C-shaped, in contrast to the elongated U-shape of other mammals; in some cebids and all catarrhines it is retroperitoneal. The caecum is large in frugivorous prosimians, short and wide in

marmosets, and hook-shaped in cebids; in catarrhines the base is globular, the body short and capacious, and the apex blunt and conical, with a terminal vermiform appendix in hominoids (Hill '58).

The colon is simple and straight in cebids such as *Saimiri*; there is a transverse colon in *Cebus* and *Aotus*, and a right colon as well in *Callicebus*, *Cacajao*, and *Pithecia*. Further elongation (and folding) occurs in callitrichids, *Lagothrix*, and all catarrhines (Hill, '58). *Taenia coli* (reduction of longitudinal muscle

into bands) are lacking in *Saimiri*, *Cebus*, and most prosimians, but there may be one or two in *Nycticebus*, *Perodicticus* (Fig. 6), *Lemur*, and callitrichids, and cebids and most catarrhines otherwise have three, except for gibbons with four (Hill, '58). The ansa coli loop in the transverse colon is common in prosimians (Fig. 6); this part of the colon is also long and dependent in apes. The capacious colon of gibbons (Fig. 10) is indicative of considerable leaf content in the diet and its potential for fermentation.

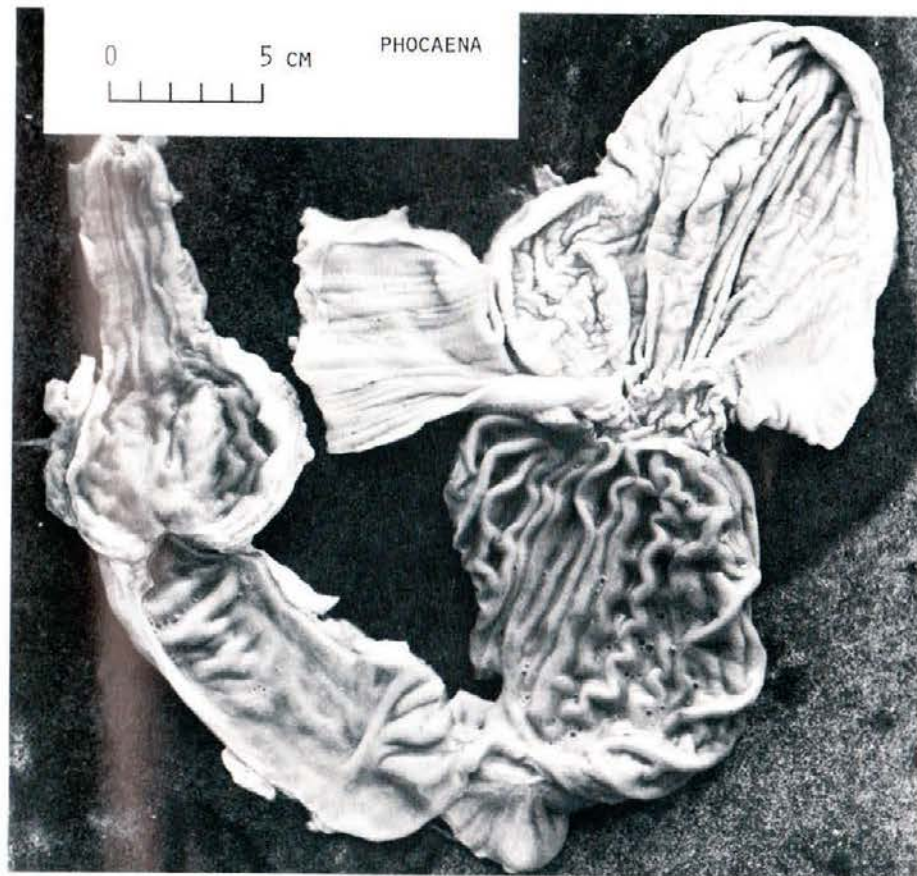

Fig. 2. The compound stomach of the harbor porpoise, *Phocaena phocaena* (D35), is shown open and flattened in a dissecting tray. The oesophagus (center) leads right into the first compartment, which in turn opens into the glandular chamber (lower); the first sphincter, opening into the pyloric tube, is just visible (lower center) leading up to the pyloric sphincter and thence into the duodenal diverticulum; the mucosal folds, which run the length of the intestine, can be seen (upper left). Photo by D.J.C. and Department of Anatomy, Cambridge University.

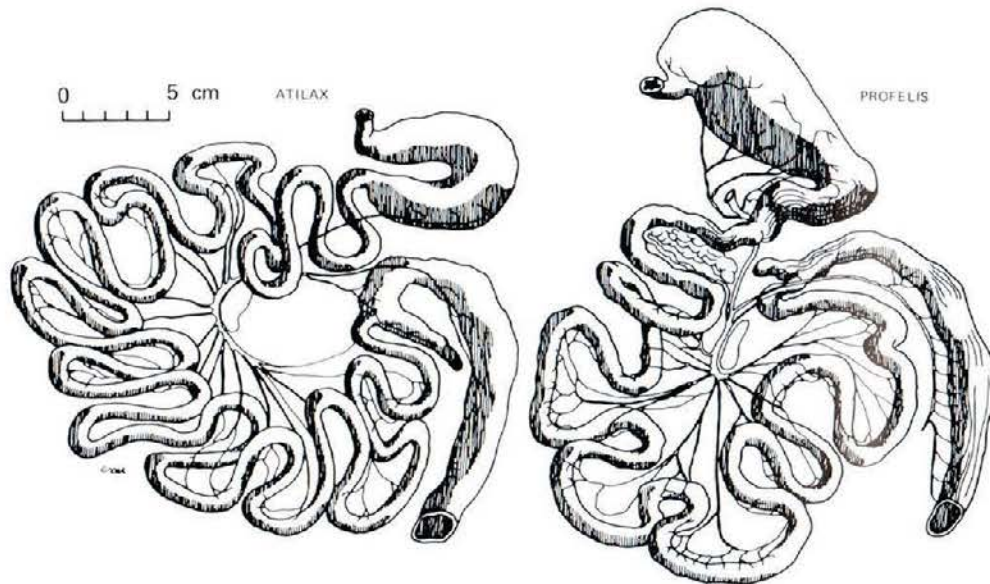

Fig. 3. Gastro-intestinal tract of *Potamogale velox* (MX) presented as in Figure 1, with the arrow marking the junction of small intestine and colon. In *Potiana richardsoni* (MS), to the right, the limit of the colon is clearly marked by a short caecum. Drawings by C.M.H.

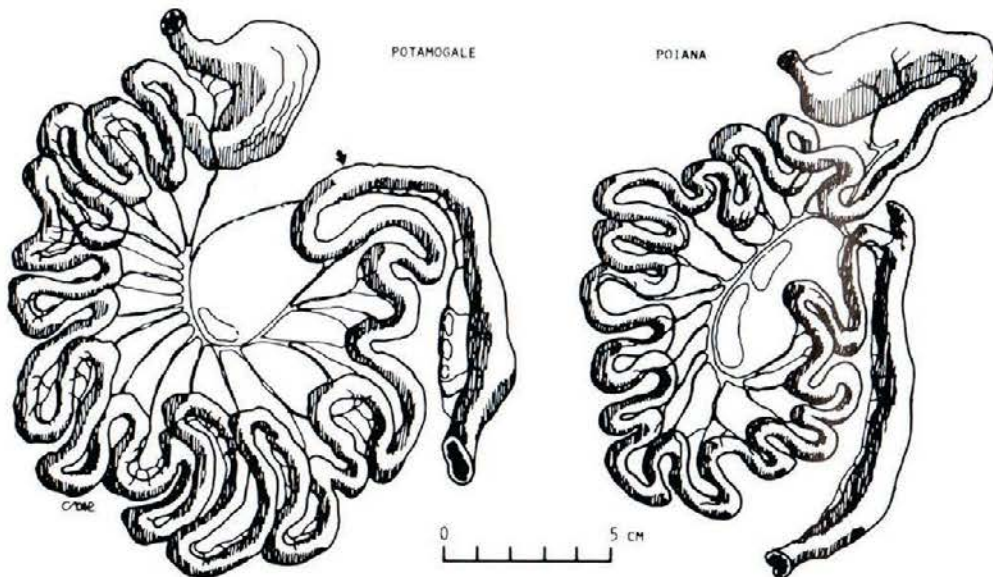

Fig. 4. Gastro-intestinal tracts of *Atilax paludinosus* (MW) and: on the right: *Profelis aurata* (MZ). Drawings by C.M.H.

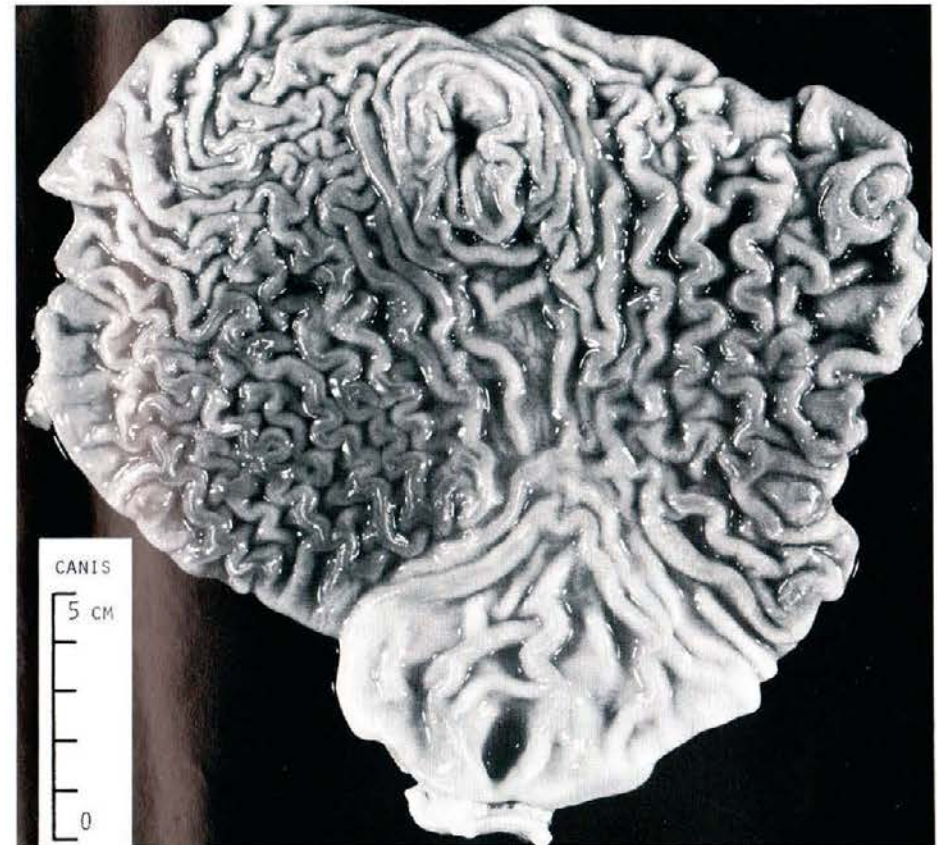

Fig. 5. Internal view of the stomach of the domestic dog, opened around the greater curvature, showing the oesophageal opening intact (at top), the extensive folded fundic region, and the paler pyloric region (lower). Photo by Department of Anatomy, Cambridge University.

#### Folivores

The long-chain  $\beta$ -linked carbohydrates predominant in the leaves, grasses, stems, barks, and gums consumed by these animals require considerable degradation by symbiotic microbial organisms. The most conspicuous adaptations are chambers for the bacterial fermentation of cellulose and for the absorption of volatile fatty acids and other metabolites, either in the stomach or in the large intestine. This dichotomy might mask further diversification as shown by the expansion of the right colon as well as, or instead of, the caecum, the presence or absence of caecotrophy, and variation in stomach structure.

The large intestine is enlarged in those prosimians which feed on leaves or gums. In

*Lepilemur* a mechanism similar to refecation (see above) allows efficient use of a diet very high in fiber content (Hladik and Charles-Dominique, '74). This case of caecotrophy is unique among primates, and helps to explain why the small intestine is one of the shortest among mammals (Fig. 11). An equally elongated and coiled caecum is found in *Phaner* and *Euticus*. Since gums require fermentation for digestion they are classified with folivores, along with *Indri*, which shows similar features (Fig. 11) and is a true folivore.

The rabbit provides the classic case of caecotrophy (Morot, 1882; Taylor, '40). In lagomorphs and myomorph rodents some faeces are reingested after fermentation in the capacious caecum, so that metabolites from the

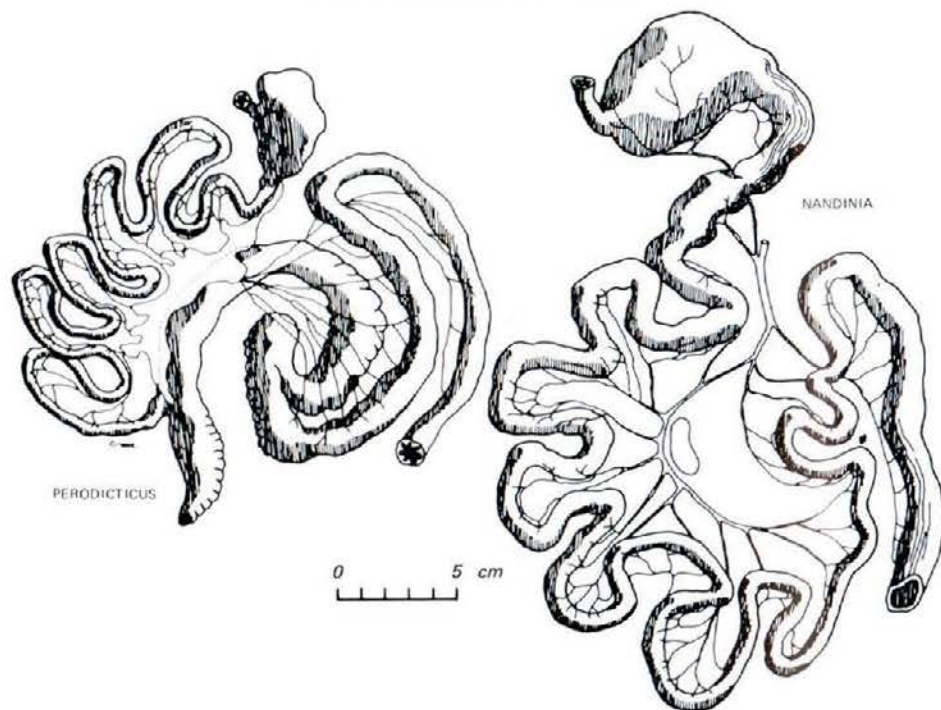

Fig. 6. Gastro-intestinal tracts of frugivores. On the left, from *Perodicticus potto* (FM), a frugivorous prosimian feeding partly on animal matter. On the right, the palm civet, *Nandinia binotata* (MY) is a carnivore feeding mainly on fruit; lacking a caecum, the junction of colon and small intestine is marked by an arrow. Drawings by C.M.H.

herbivorous diet can be absorbed in the small intestine.

The caecum is very coiled and elongated in specialized folivores, such as the "gliding" squirrel *Anomalurus* (Fig. 11)—even more so than in *Lepilemur*. The most complex large intestine is found in *Dendrohyrax* (Fig. 12), where the first caecum is followed by two more after about 20 cm of colon.

With enlargement of the colon in mammals the migration of the ileo-caeco-colic junction can be traced from the left cranial part of the abdominal cavity round to the right caudal aspect, so that the caecum comes to point caudally rather than cranially (Hill, '58). In those species with a voluminous caecum, however, cranial rotation has occurred so that it comes to occupy the ventral part of the abdomen, as in the horse (Fig. 13). Perissodactyls and proboscids have large colic loops in addi-

tion to the huge sacculated caecum for the breakdown of their fibrous diet. As in other mammals which cope with this kind of diet, the horse has a large area of keratinized epithelium in its stomach, which, however, remains simple (Fig. 14). Carleton ('73) suggests that the variable cornification of the stomach lining in different species of cricetine rodents might be correlated with the amount of cellulose in the diet.

In contrast to perissodactyls, proboscids have a large folded stomach and a short small intestine of large internal area. Sirenians, such as the dugong, have a complex two-chambered stomach, with one part fulfilling the role of the duodenum; they also have a very wide caecum (Grassé, '55).

The most elaborate tracts are found in those folivores, usually subsisting almost entirely on grasses, with complex stomachs for bacte-

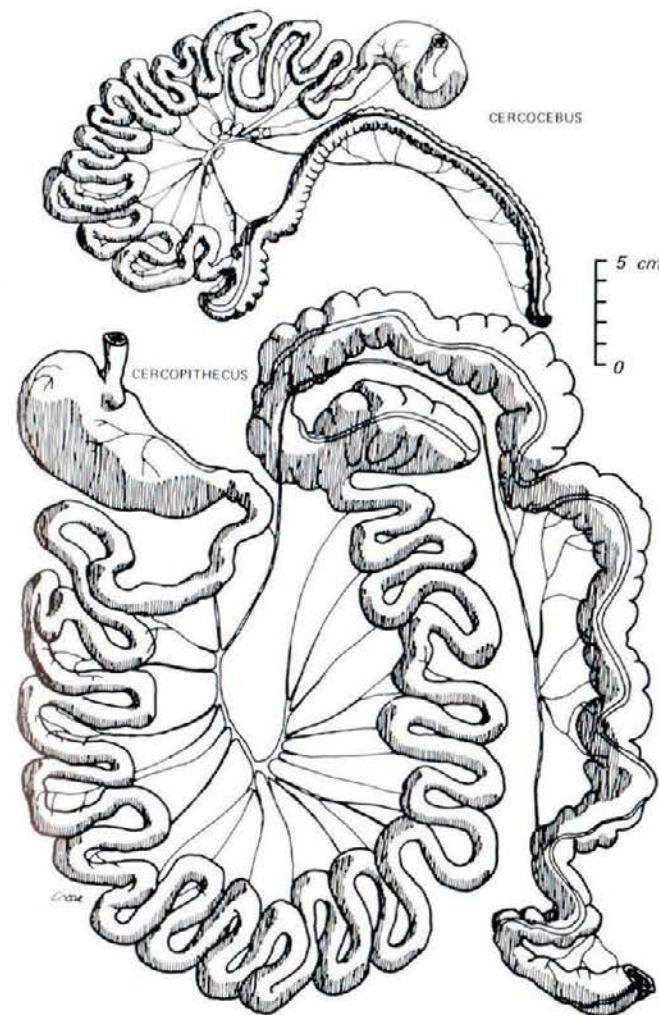

Fig. 7. Gastro-intestinal tracts of frugivorous monkeys. Above, the mangabey *Cercopithecus albigena* (FF, juvenile), and below, the guenon *Cercopithecus cephus* (FD). Drawings by C.M.H.

rial fermentation, as exemplified by the artiodactyl ruminants. Macropod marsupials, some edentates, hippopotami, camels, and colobine monkeys show evolutionary convergence with ruminants in their adaptations of stomach structure for folivory (Moir, '68). In these groups there is actually a continuum of diets from frugivore to folivore, as shown in the preceding section for pigs and peccaries (whose stomachs show some similarity to

those of ruminants). Among the ruminants, for example, there are pure frugivores, such as *Cephalophus* and *Hyemoschus* (chevrotain), intermediate types such as the spotted deer *Axis*, and pure folivores, such as *Neotragus*, or pure herbivores, such as the buffalo *Syncerus* (G. Dubost, pers. comm.). These extremes of the continuum are the most specialized forms.

Macropod marsupials have a long tubular stomach, sacculated along much of the greater

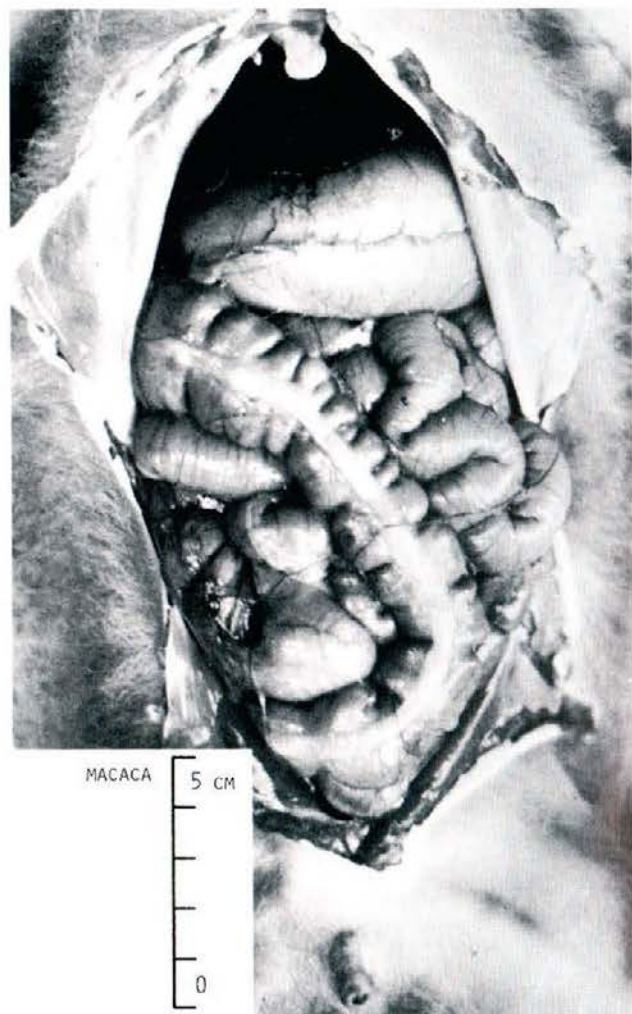

Fig. 8. The disposition of the gastro-intestinal tract within the abdomen of the long-tailed macaque, *Macaca fascicularis* (P21). Note small size of stomach (above), position of caecum (lower left), and loops of colon, with taenia coli (center). Photo by D.J.C.

curvature, with an oesophageal groove (ruminant feature linking oesophagus with omasum) (Grassé, '55). The stomach leads into a long intestine with a wide caecum. Among folivorous edentates, such as the sloth *Bradypus*, there is a keratinized cardiac region, a small "rumen" with two diverticula and an oesophageal groove, and an "abomasum" with an expanded pyloric region with a very thick

muscular wall.

The hippopotamus has the oesophagus opening into a vestibule, into which open two unequal diverticula, and which leads into a third tubular chamber; all three chambers have stratified epithelium thrown into projecting folds with numerous papillae. There is a very long intestine, but no caecum. Camels have a stomach that is smooth and ovoid in

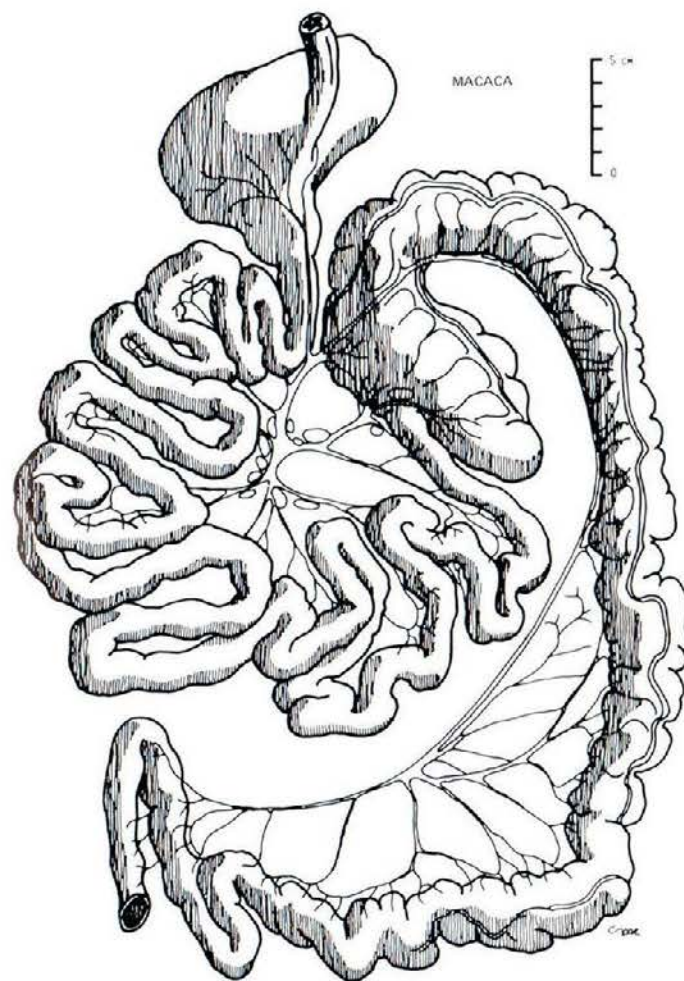

Fig. 9. Gastro-intestinal tract of the barbary macaque, *Macaca sylvana* (FO), showing a rather larger colon than occurs in other frugivorous primates, which correlates with a diet including large amounts of plant matter. Drawing by C.M.H.

shape, composed of two glandular sacs; the omasum and abomasum are merged into a single tube.

Colobine monkeys have a similarly large and complex stomach, with much distension and sacculations proximally and a U-shaped tube distally, sacculated along the proximal part of the greater curvature (Hill, '58). These sacculations are produced by the reduction of longitudinal muscle into two or more bands (taenia). The stomach of African colobines is more elongated, with the tube bent back on

the sac, than in Asian colobines, where the sac is roughly spheroidal (Fig. 15, cf. Kuhn, '64). The colon is long and sacculated, and the caecum is of moderate size (Fig. 15), as in other Old World primates.

The artiodactyl ruminants are well known for their four-chambered stomach (Comline et al., '68), which is dominated by the vast rumen, divided into dorsal and ventral sacs by muscular pillars, and covered by keratinized squamous epithelium with papillae of varying size and shape (Fig. 16). The oesophagus

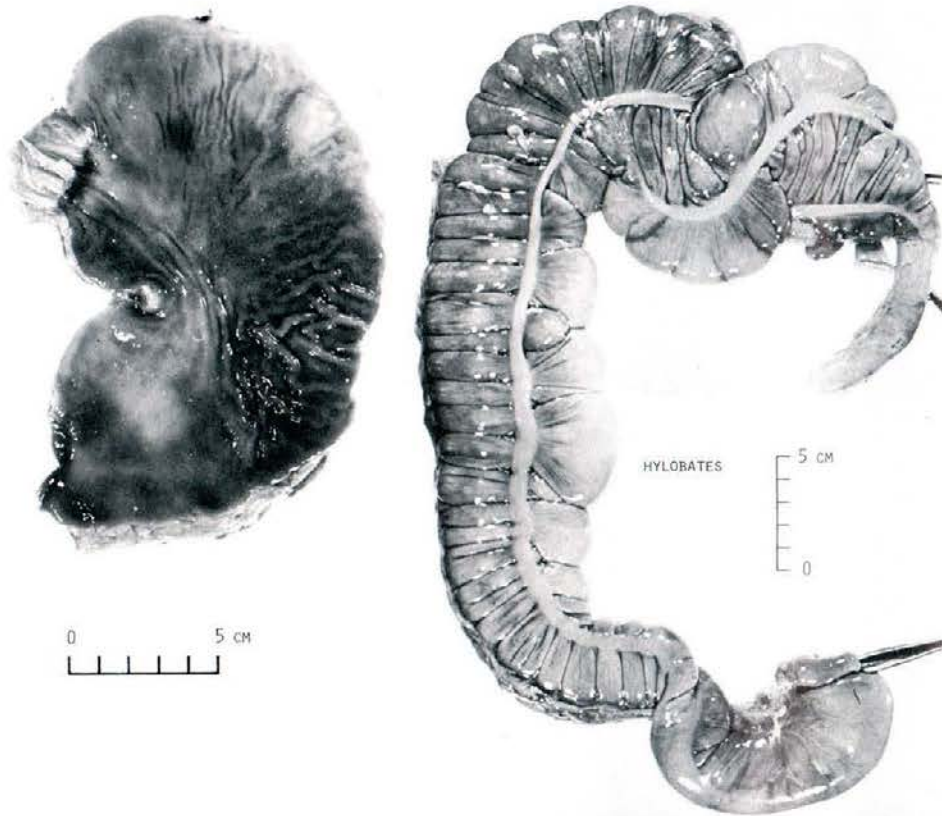

Fig. 10. On the left, an internal view of the stomach of the siamang, *Hylobates syndactylus* (P27), opened around lesser (to left) and greater curvatures and laid out in a dissecting tray; the oesophagus opens at the upper left, with a dark region of cardiac glands, and the pyloric sphincter is at the lower left. On the right, an external view of the siamang's large sacculated colon, with taenia coli, partly distended with, and immersed in, water; the ileum is clamped by forceps in the upper right, where the vermiform appendix projects down from the caecum. The lower end of the left (descending) colon is clamped in the lower right. The large volume relates to the large intake of leaves in its diet. Photos by the Department of Anatomy, Cambridge University.

opens into a much smaller reticulum, which has a distinctive honeycomb pattern of ridges (hexagonal in cow and sheep, pentagonal in goats) and is covered by small conical papillae. The rumen connects with the glandular part of the stomach through the small ovoid omasum, which is partitioned by many leaves of varying size for water absorption. The internal surface of the glandular abomasum is thrown into folds throughout the fundic region (Fig. 16). The intestine is again very long, the caecum is relatively short, and the colon is long and elaborately flexed and coiled.

Efforts at demonstrating homologies with the ruminant stomach of bovids have had

limited success. For example, the stomach of New World camelids has only three compartments, with the ventricular groove running from the first to the last; only the terminal fifth of the third, tubular compartment has true fundic and pyloric glands (Vallenas et al., '71). While this chamber has mucosal pleats over much of the rest of its length, the first two sac-like compartments have areas of large glandular saccules, which not only contain considerable amounts of ingesta, but are capable of frequent eversion. Thus, they seem more likely to contribute secretions to buffer stomach contents, rather than to absorb water. It is claimed that such structures aid

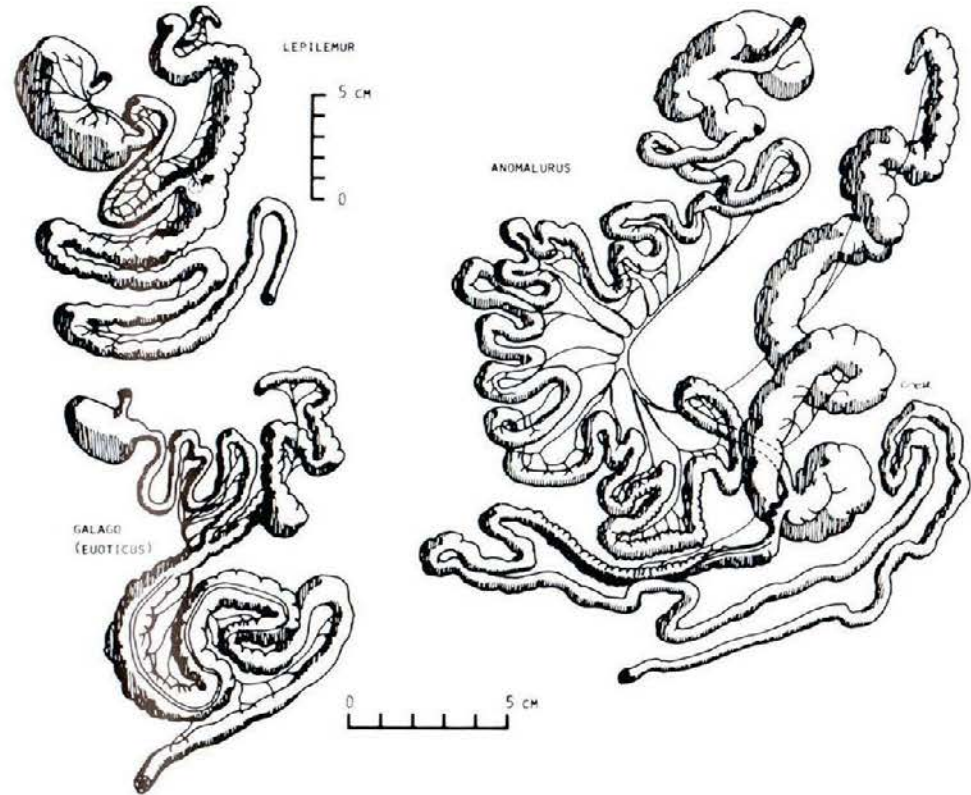

Fig. 11. Gastro-intestinal tracts of folivorous prosimians (left) and a rodent with extreme development of the caecum related to their specialized diets. The sportive lemur, *Lepilemur leucopus* (DO), upper left, has the shortest small intestine of all primates; it is the only genus in which caecotrophy occurs and the ileo-caeco-colic "plate" (arrowed) probably plays an important role in regulating this behavior (Charles-Dominique and Hladik, '71). The needle-clawed bush-baby, *Galago (Euoticus) elegantulus* (DV), lower left, shows a similar morphology adapted to the digestion of gums, composed of long-chain carbohydrates, that also require fermentation. The flying squirrel, *Anomalurus fraseri* (MT) has a similar gut morphology related to a diet known to be mainly leaves. Drawings by C.M.H.

in a greater efficiency of digesting poor-quality vegetation at high altitudes, where cattle and goats cannot graze.

Janis ('76) suggests that horses also have an advantage over cattle in their ability to use a more fibrous diet of low protein content, by taking in larger quantities which pass through more rapidly, rather than developing a more efficient digestion of cellulose. In discussing the evolutionary strategy of equids, in terms of physiology and ecology, she contrasts their digestive system with that of ruminants, and refers to the greater extension of caecum and colon in those nonruminant herbivores that do not practice caecotrophy.

In conclusion, this review of the principal distinguishing features in the mammalian gastro-intestinal tract has emphasized the simple stomach and long small intestine of mammals known to subsist mainly on animal matter, and the elaboration of the stomach and/or small intestine in leaf- or grass-eating forms, with frugivores showing an intermediate morphology (Table 1). Most mammalian features of gut morphology, except for the more specialized, occur among primates, which form an array derived from primitive unspecialized forms and which have not attained the extreme adaptations found in other orders. Didelphid marsupials, adapted to a sim-



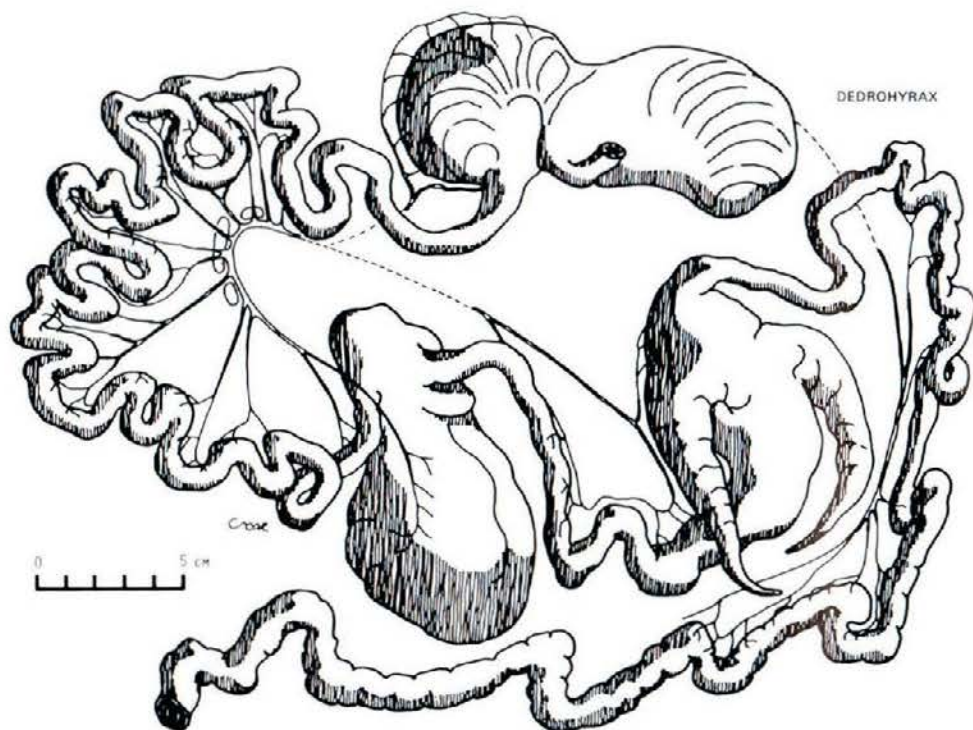

Fig. 12. Gastro-intestinal tract of the tree hyrax, *Dendrohyrax dorsalis* (MU), showing the most complex arrangement of caeca and colon, the exact functions of which are not yet known. Drawing by C.M.H.

order. Didelphia marsupials, adapted to a similar range of diets, show even less morphological specialization than lorimid and cheirogaleid primates (Charles-Dominique and Hladik, unpubl. observ.); this supports the idea that the gastro-intestinal tract has paralleled other aspects of mammalian evolution.

It has been seen how variations in proportions of different parts of the tract, with certain structural peculiarities, can often be related to different aspects of diet. In some cases the correspondence is not obvious; references to the lengths of various regions are inadequate for a full functional interpretation. A fuller quantitative analysis is necessary to investigate the relationships within and between dietary groups. Having set the scene and illustrated the problems in this survey, we can now proceed with this more detailed evaluation.

#### QUANTITATIVE ANALYSIS OF GUT MORPHOLOGY

##### Methods

Gastro-intestinal tracts were taken from 180 individuals of 78 mammalian species in England, France, Morocco, Gabon, Madagascar, Sri Lanka, Malaysia, and Panama. There are 117 primates of 48 species, 13 temperate mammals of 7 species (2 aquatic), and 24 tropical nonprimate mammals of 17 species. One-hundred forty-eight specimens were caught in their natural habitat by hunters during pest control operations or by local people for food; 29 animals, mostly primates, died in captivity, from illness or old age. In addition, 26 domestic mammals of six species were put down during routine marketing, research, or teaching operations.

Larger samples of certain species indicate the level of intraspecific variation, and the

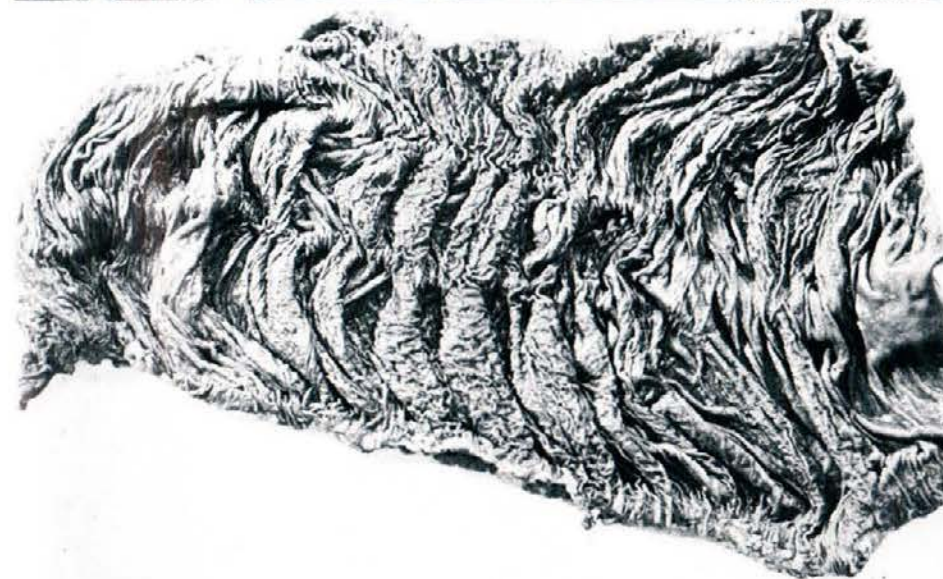

Fig. 13. The large intestines of the domestic horse (D14) showing, above, external shape and large size of the caecum (center) surrounded by dorsal and ventral loops of the primitive right colon, with sternal and diaphragmatic flexures (lower) and the smaller size of the transverse and left colons, also with taenia coli (lower left corner). Below, the internal appearance of the caecum after opening and washing, before cutting the taenia coli, which increases the length from 80 to 240 cm. Photos by the Department of Anatomy, Cambridge University.

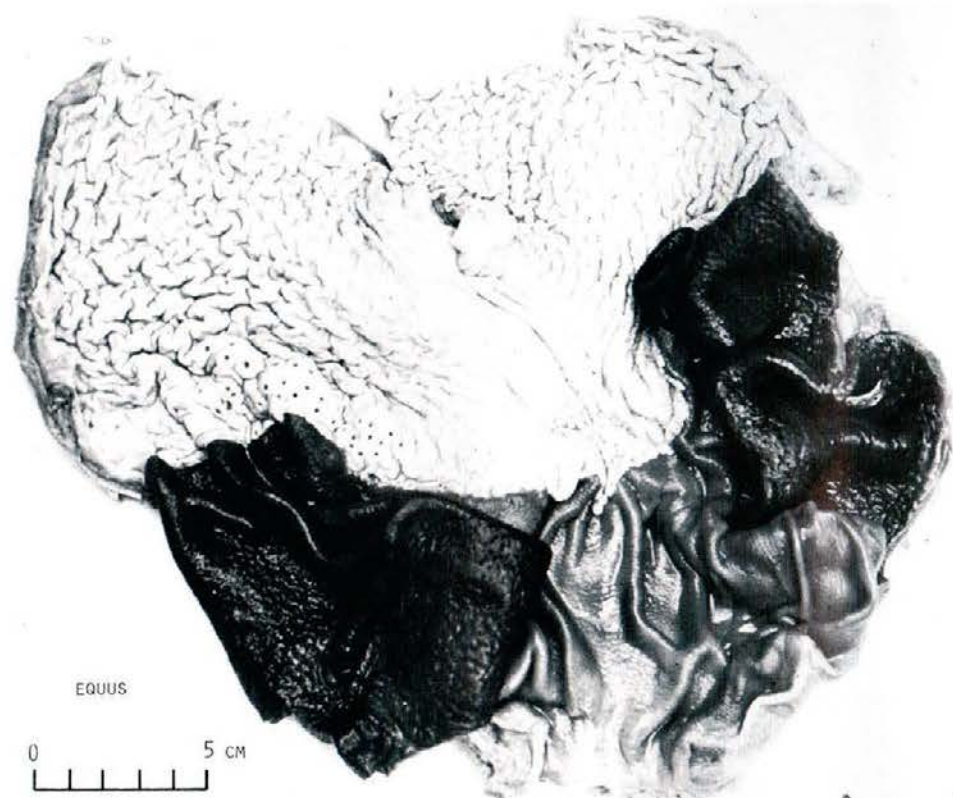

Fig. 14. Internal aspect of the stomach of the domestic horse (P14), opened around the greater curvature to show the large extent of folded, keratinized mucosa around the oesophagus (cf. Figure 2) and up into the sacculus caecus (above), the dark, fundic mucosa (to left and right), and the pyloric mucosa (below and center). The sites of attachment of bot-fly larvae can be seen just above the margo plicatus (termination of "oesophageal" mucosa) on the left. Photo by the Department of Anatomy, Cambridge University.

reliability of small samples. Thirty-seven of the 78 species are represented by only one specimen, 15 species by only two, and 10 species by three individuals. There are four specimens of *Galago* (*Euoticus*) *elegantulus*, *G. alleni*, *G. demidovii*, *Alouatta palliata*, *Cercocebus cephus*, *C. nictitans*, *Presbytis obscura*, and the domestic goat; five specimens of *Arctocebus*, *Cheirogaleus*, *Miopithecus*, *Vulpes*, and *Dendrohyrax*; six specimens of *Presbytis melalophos* and the domestic cat; and nine domestic dogs.

Specimens were weighed intact, which was not always possible in the field, and their lengths were measured from bregma to ischium and from tip of nose to base of tail. The latter measure of length was not used in this

analysis, because of the distortion introduced by varying lengths of muzzle, especially when contrasting primates with other mammals. The guts of most specimens were examined and measured in the fresh state (or were preserved in a saturated saline and then washed in water); seven had to be fixed for later study in 10% formol saline, but measurements under these conditions are affected adversely by contraction at the time of fixation. Many specimens were examined, drawn, and photographed with the guts in situ and/or displayed under water in a large dissecting tray. The dimensions of each region were then measured, for calculations of area and volume, and weighed after the removal of excess moisture.

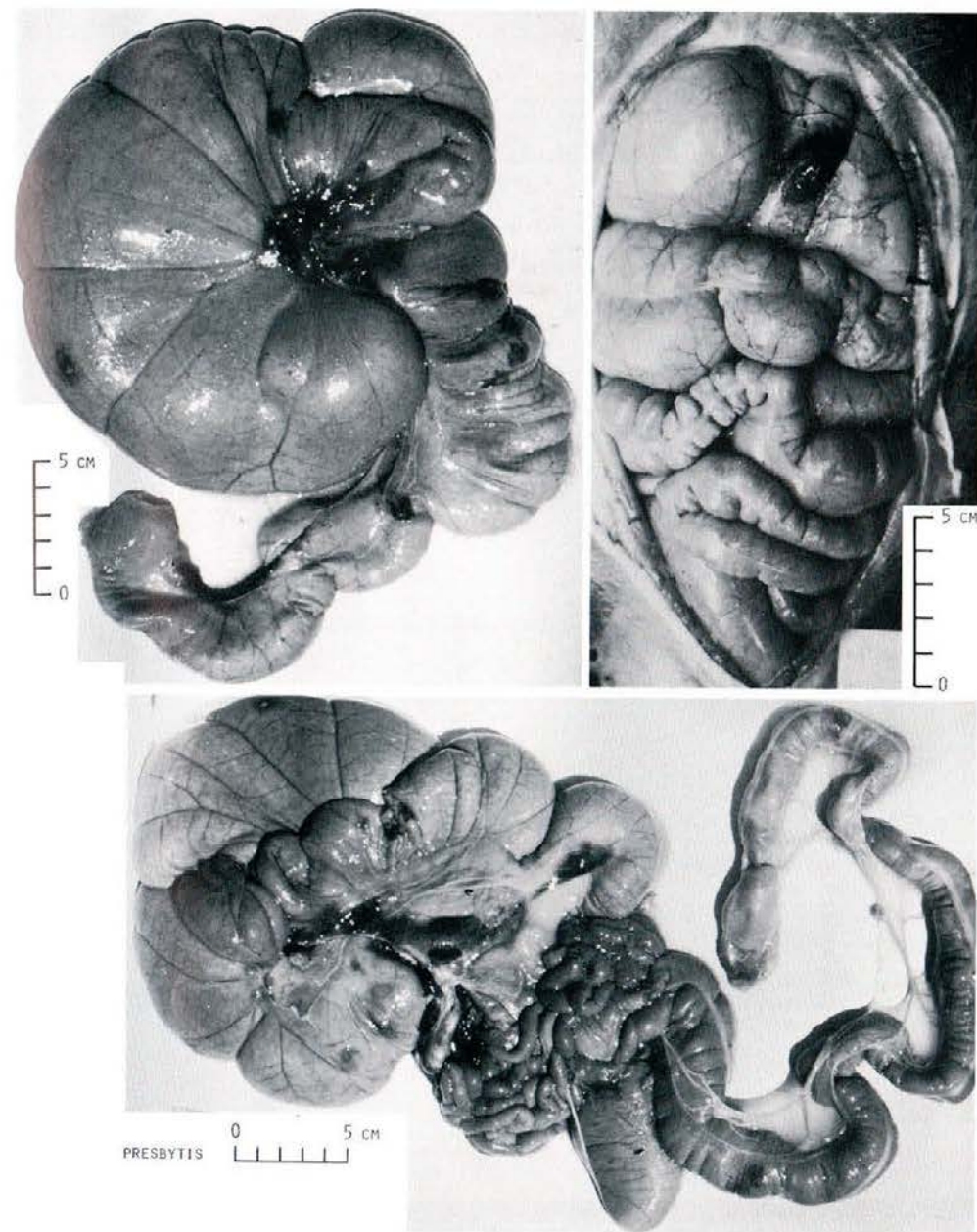

Fig. 15. The gastro-intestinal tract of the dusky leaf monkey, *Presbytis obscura* (P19). Upper right, the disposition within the abdominal cavity; note the large size of the stomach occupying the upper half of the view, and the coils of colon below (cf. Fig. 8). Upper left, the stomach (partially distended with water) displayed to show the large sac, the gastric tube (on the right), and the pylorus (lower left). Below, the complete abdominal part of the tract, with a different aspect of the stomach on the left, and the coils of small intestine, caecum (directed downwards), and colon leading around into the rectum, successively to the right. Photos by D.J.C.

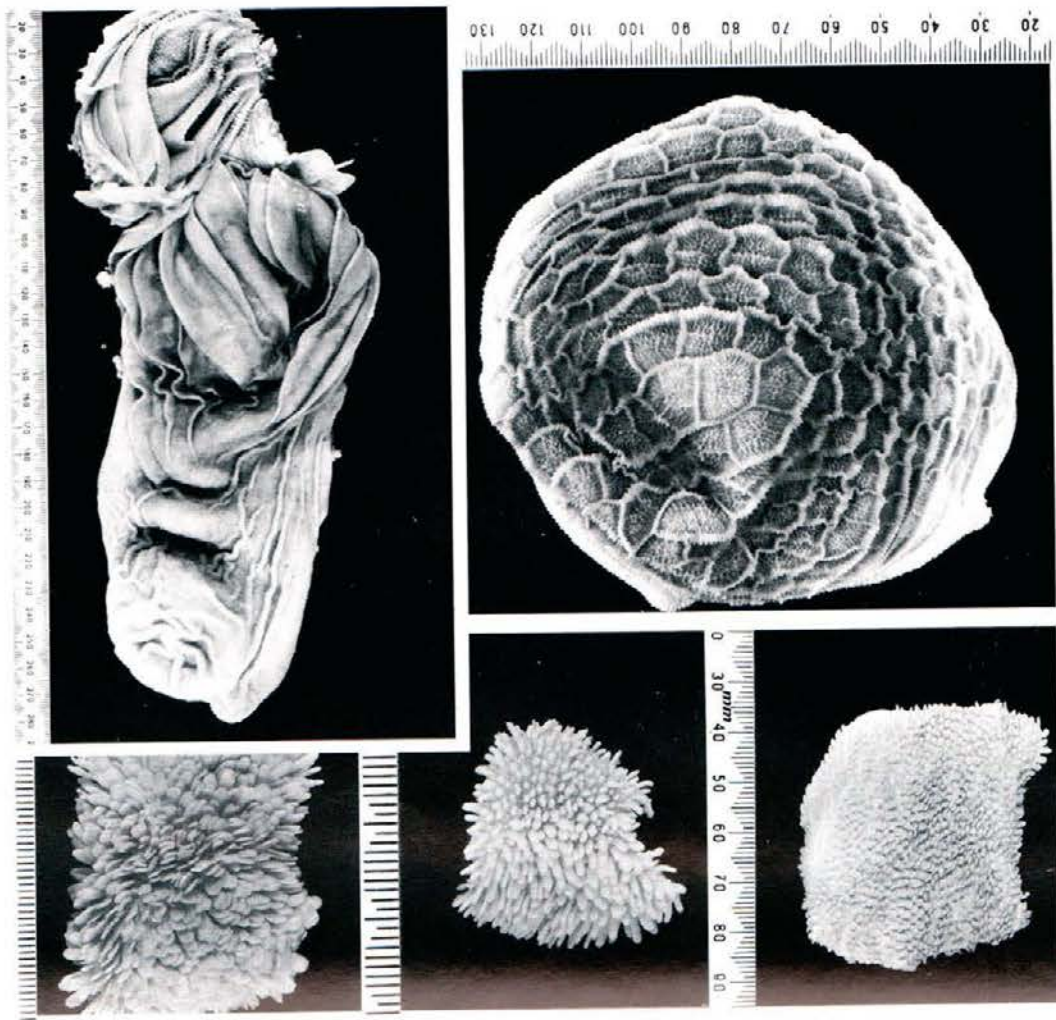

Fig. 16. Internal structural features of the stomach of the domestic goat (DO2). Upper left, the honeycomb pattern of ridges and small conical papillae in the reticulum. Right, papillae of varying size and shape from different parts of the rumen. Below left, the "leaves" and small pointed papillae in the omasum (on left), the long folds of the fundic part of the abomasum (center), and the paler pyloric mucosa with a few small folds (right). Photos by Department of Anatomy, Cambridge University.

TABLE 1. Summary of adaptations of the gastro-intestinal tract in various orders of mammal, according to the predominance of either animal matter or fruit or leaves in their diet

Dietary Category	Mammalian Order	Features of Gastro-intestinal Tract				
		General	Stomach	Small Intestine	Caecum	Colon
Faunivores	Insectivora	$2\frac{1}{2}$ -7 × BL <sup>1</sup>	simple	very short	none	
	Chiroptera	- $\frac{1}{5}$ BL	blind-ending tube			very short
	Primates		simple, globular	tortuous	short, conical	simple, smooth-walled
	Carnivora		simple	4-6 × BL	small or absent	reduced
	Edentata	7 × BL	"muscular tooth"		none	
	Pholidota		"muscular tooth," cornified, stones			
	Cetacea		3 chambers, 2 sphincters	very long	none	very short
	Rodentia		gastric gland changes			
Frugivores	Chiroptera		rel. complex, distinct cardiac region, long pyloric divertic., lat. 'caecum'		small or absent	
	Primates		simple, globular	C-shaped duodenum retroperitoneal	small-large	elongated, folded, taenia reduced
	Carnivora		zones, even chambers	very long	none	rel. complex
	Artiodactyla		extensive cardiac glands, separated from fundus by fold		large	
	Rodentia				none	
Folivores	Marsupalia, macropod		long, tubular, sacculated, grooved	long	wide	
	Primates					
	lemurid	caecotrophy	simple	very short	elongated, coiled	
	colobine		sacs and tube			
	Proboscidea		large, folded	short, capacious	huge, saccul. very wide	large loops
	Sirenia		2-chambered		3 caeca	most complex
	Hyracoidea		cornified area		huge, saccul.	large loops
	Perissodactyla					
	Artiodactyla					
	hippopotamid		3 chambers	very long	none	
	NW camelid		3 chambers			
OW camelid		2 sacs, smooth, ovoid				
bovid	most elaborate	4 chambers, huge elaborate	long	large	long, folded and coiled	
Edentate		cornified cardia, 'rumen', groove, 'abomasum'				
Rodentia	caecotrophy	cornified variably		capacious v. coiled, long		
Lagomorpha	caecotrophy					

<sup>1</sup> BL = Body length.

Techniques were standardized throughout between the two authors, on occasions when they worked together, so as to obtain comparable accuracy. Several hours were allowed to elapse after the death of the individual to permit complete relaxation of muscle tone in the gut wall. Measurements of length and breadth of stomach, small intestine, caecum, and colon were then made without stretching, after opening and flattening the gut wall, usually under water in a dissecting tray (except for the larger specimens). Because different parts of the gut can be fully contracted or relaxed, simultaneously or sequentially, this seems to be the best compromise in functional terms for measuring, for comparative purposes, what is a very malleable system.

The surface areas of small and large intestines were calculated from lengths and a series of breadths; sometimes it was more appropriate to treat the caecum as a triangle rather than an elongated rectangle. The irregular shape of the stomach required summing the area of its parts, usually arranged to cover the different compartments or division into fundus and pylorus. The areas of such nontubular parts were also measured by cutting pieces of aluminum foil to the exact shape of the part(s) immersed under water, and then weighing for

calculation from the weight of unit area; this provided a means of checking the accuracy of length and breadth measurements. Error resulting from the different methods, or from repeated measurements, amounted to less than 5%.

Little merit was placed on measuring volumes by distending parts of the gut with water (even if the pressure could be controlled), if only because of the possible distortion of subsequent measurements of area. Latterly, however, some comparative measurements were made in this way (Table 2). Usually, small and large intestines were considered as cylinders for the calculation of volumes (V) from their surface area ( $A = b \times l$ ),

$$V = \pi \left( \frac{b}{2\pi} \right)^2 0.1 = 3.142 \left( \frac{b}{6.283} \right)^2 0.1,$$

and stomachs were treated as spheres,

$$V = \frac{4}{3}\pi \left( \sqrt{\frac{A}{4\pi}} \right)^3 = 4.19 \left( \sqrt{\frac{A}{12.57}} \right)^3 \text{ (Table 3).}$$

For stomachs, similar results were obtained in a few cases by calculating the volume from the greater curvature, assuming its length (L) to be the circumference of a sphere,

$$V = \frac{4}{3}\pi \left( \frac{L}{2\pi} \right)^3 = 4.19 \left( \frac{L}{6.283} \right)^3 \text{ (Table 3).}$$

Volumes calculated from surface area are about 12% less on average than those from greater curvature or water-filling (Tables 2 and 3).

While all species can be compared against a common standard (calculating volumes from spheres of equivalent surface area), distortions occur in the case of species with a complex

stomach, where the whole clearly does not approximate a sphere. While some compartments resemble spheres (the ruminant reticulum, rumen and omasum, and the colobine presacculus and saccus), others approximate cylinders (the ruminant abomasum and the colobine gastric and pyloric tubes). Thus, volumes have been recalculated along these lines (Table 4), yielding values one-third less on average. Even the calculations of volumes of simple stomachs (whether from surface area or length of greater curvature) give variable

TABLE 2. Estimation of gut volumes: filling stomach with water without stretching wall, compared with calculations from the surface area of a sphere; with comparative data from the small intestine and colon, treated as cylinders

Species	Volumes, cm <sup>3</sup>		
	water-filled	surface area	greater curvature
<b>Apes</b>			
<i>Hylobates syndactylus</i>			
stomach	240	156 -	264
intestine	350	385 +	296
colon	950	697 -	
	550	461 -	
	1150	941 -	
	850	1127 +	
<i>Hylobates pileatus</i>			
stomach	580	499 -	
intestine	500	596 +	
colon	1500	954 -	
<b>Wild mammals</b>			
<i>Vulpes vulpes</i>			
stomach	270	538 +	
	600	621 +	
	300	392 +	
intestine	480	329 -	
	410	302 -	
	470	340 -	
colon	50	100 +	
	180	151 -	
	150	136 -	cf. water-filled

TABLE 3. Estimation of stomach volumes: considering the stomach as a sphere, and calculating volume from (a) length of greater curvature (L), equivalent to circumference and (b) surface area (A)

Species	Volume, cm <sup>3</sup>		latter cf. former
	Greater curvature	Surface area	
<b>Prosimians</b>			
<i>Arctocebus calabarensis</i>	9	5	-
<i>Avahi laniger</i>	12	19	+
	23	39	+
	46	62	+
<i>Cheirogaleus major</i>	9	10	=
	9	14	+
	5	9	+
	17	24	+
<i>Galago alleni</i>	17	8	-
	17	9	-
	4	6	+
<i>Galago demidovii</i>	2	2	=
	2	1	-
	1	1	=
	3	2	-
<i>Lepilemur mustelinus</i>	17	28	+
<i>Perodicticus potto</i>	2	3	+
<b>New World monkeys</b>			
<i>Leontocebus midas</i>	4	4	=
<i>Cebus griseus</i>	37	53	+
	29	31	+
<i>Alouatta seniculus</i>	205	227	-
<i>Ateles paniscus</i>	264	212	-
<b>Old World monkeys</b>			
<i>Miopithecus talapoti</i>	29	27	-
	46	42	-
	23	32	+
<i>Cercopithecus neglectus</i>	264	163	-
<i>Cercopithecus nictitans</i>	135	93	-
	57	59	+
	297	221	-
<i>Cercopithecus aethiops</i>	29	19	-
	6	5	-
<i>Cercocebus albigena</i>	135	130	-
	12	15	+
	135	82	-
<i>Macaca sylvanus</i>	29	20	-
<i>Papio papio</i>	9	8	=
<i>Papio sphinx</i>	9	7	-
<b>Ape</b>			
<i>Pan troglodytes</i>	1079	965	-
	135	72	-
<i>Pan gorilla</i>	116	88	-

results, apparently according to the degree of elongation of the stomach spindle.

### Results

The data collected, and resulting basal calculations, are displayed in tables 5–8 for prosimians, New World monkeys, Old World monkeys (cercopithecine and colobine), apes, domestic mammals, and wild mammals (temperate and tropical). Emphasis is placed on adult animals taken from their natural habitat, since considerable changes in gross dimensions may occur in captivity, even after short periods, e.g., from a 33% reduction to an 100% increase in the surface area of the small intestine in some cercopithecines (Hladik, '67). Immature individuals are particularly susceptible to dietary effects on gut proportions, and their measurements should be treated with caution; the stomach and colon are relatively reduced in young folivores, and may be increased in faunivores. Fixed specimens are also liable to distortion from the functional state.

**Gut Differentiation.** The sizes of stomach and large intestine relative to small intestine, in terms of surface area, weight, and volume, provide a simple quantitative index of gut differentiation, without regard to the size of the animal. These coefficients of gut differentiation vary considerably in the mammals studied, from tracts that are dominated by small intestine in faunivores to those that are dominated by stomach and/or large intestine in folivores.

Considering surface areas, the coefficients of gut differentiation show considerable overlap between species of the three main dietary categories (Fig. 17). This overlap is explained to some extent by intermediate diets. The plots on a logarithmic scale represent species means, with the range of variation marked for those species with four or more specimens. While the values of the coefficients appear generally to represent structural adaptations indicative of the relative proportions of animal and plant matter in the diet, only those below 0.2 can be regarded as true faunivores and only those above 3.0 as exclusive folivores.

Interspecific variation may be appreciated more clearly by comparing coefficients within (and between) the various taxonomic or ecological groups of mammal (Fig. 18). In each of these groups dietary categories, as suggested by structure, are separated, albeit in different ways, with values for frugivores clustered around 1.0. This is especially marked among primates, with higher values reflecting a tract dominated by stomach and/or large intestine (for digesting leaves), and the few lower ones, among prosimians and ceboids, where the small intestine predominates (for digesting animal matter). The categories of "faunivore," "frugivore," and "folivore" are established according to structural discontinuities, and at this stage they can be no more than suggestive of diet. The overlap between them would seem to result from interspecific variation in the degree of admixture of animal, fruit, and leaf foods, which would be especially variable among frugivores.

TABLE 4. Estimation of stomach volumes: complex stomachs, treated (a) as a single sphere and (b) as a combination of spheres and cylinders

Species	Volume, cm <sup>3</sup>			n
	Single sphere	Spheres & Cylinders	% reduction of latter	
Domestic mammals				
<i>Capra</i> (goat)	17,776	11,365	36	4
<i>Ovis</i> (sheep)	13,615	7,954	42	3
Colobine monkeys				
<i>Presbytis cristata</i>	5,171	3,259	37	2
<i>Presbytis obscura</i>	4,124	2,767	33	4
<i>Presbytis melalophos</i>	3,917	2,313	41	5
<i>Presbytis rubicunda</i>	3,547	2,259	36	1
<i>Nasalis larvatus</i>	8,270	6,523	21	1
<i>Pygathrix nemaeus</i>	4,605	3,199	31	2
			$\bar{x} = 33$	
<i>Colobus polykomos</i>	3,147	2,108		2
<i>Presbytis senex</i>	3,856	2,584		2
<i>Presbytis entellus</i>	5,532	3,706		2

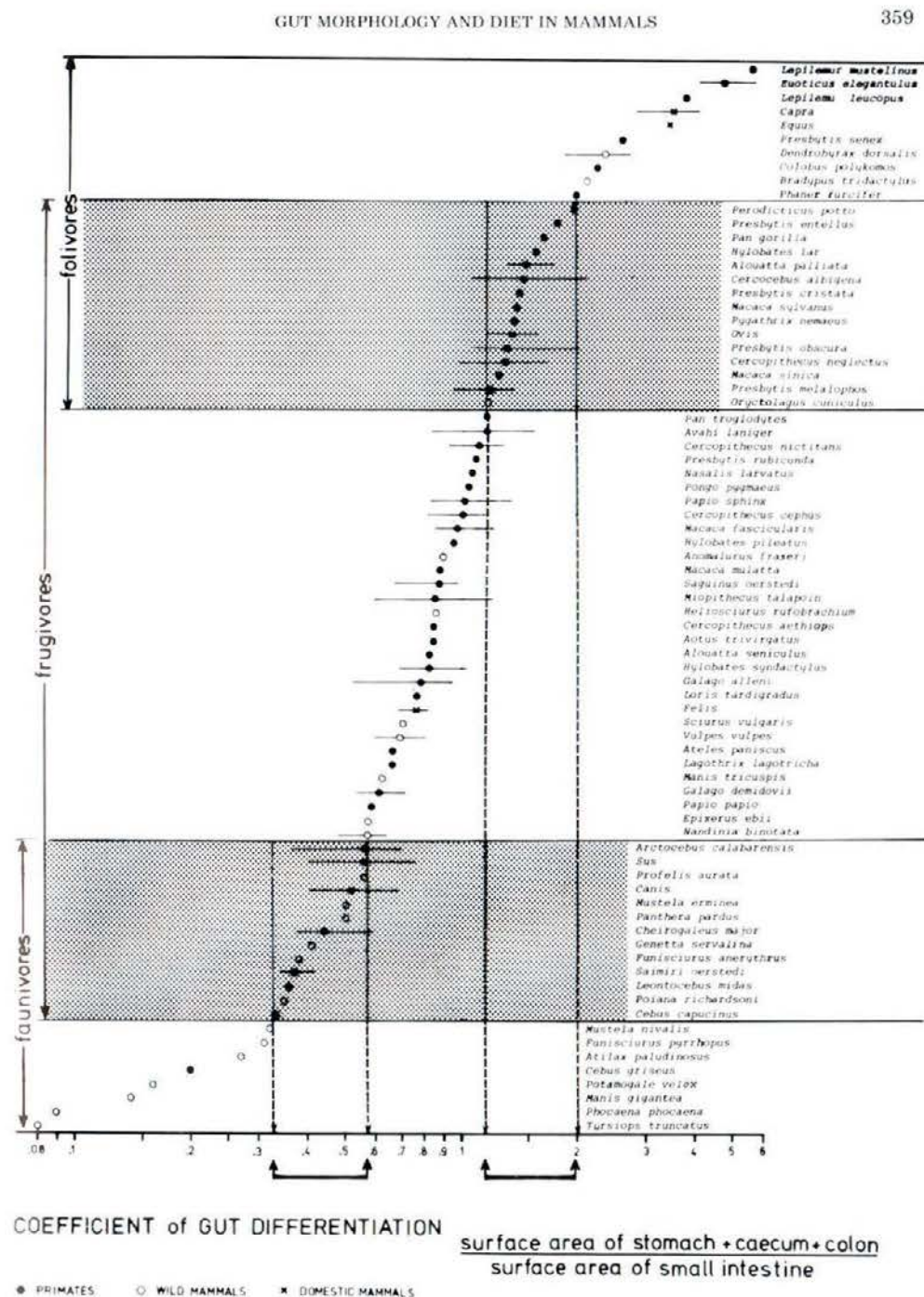

Fig. 17. Coefficients of gut differentiation from surface area plotted in order of magnitude (smallest values below) on a logarithmic scale, indicating by arrows and stippling the three main morphological dietary categories and the overlap between them, which may or may not include species with intermediate diet. Range of values are denoted by horizontal lines for species with more than one specimen.

TABLE 5. Measurements of body length and weight, and of surface area, weight and volume of stomach, small intestine, caecum, and colon in prosimians and New World monkeys

Species	Ident. no. <sup>1</sup>	Sex	Body length cm	Body weight gm	Surface area, cm <sup>2</sup>				Weight, gm				Volume, cm <sup>3</sup>			
					Stom.	S.I.	Caec.	Colon	Stom.	S.I.	Caec.	Colon	Stom.	S.I.	Caec.	Colon
Prosimians	AY2	M	22	220	14	146	10	29					5	21	1	3
	DT	M	22	160	30	126	9	36					15	18	1	7
<i>Arctocebus calabarensis</i>	ER	F	22	190	24	110	10	38					11	15	1	5
	EV	M	21	160	26	111	10	41	5	6	0	3	13	17	2	6
	FC	M	21	180	12	88	6	29	5	4	1	3	4	11	1	4
	BP	M	24		34	337	165	165					19	39	87	26
<i>Avahi laniger</i>	BQ	M	25		56	309	107	95					39	43	40	12
	BR	F	25		76	335	186	255					62	43	72	54
	AK <sup>1</sup>	M	21		23	94	4	22					10	11	1	4
	BF <sup>1</sup>	M	22		28	143	5	51					14	15	1	10
<i>Cheirogaleus major</i>	BG <sup>1</sup>	F	23		20	162	7	33					9	18	1	7
	BH <sup>1</sup>	F	23		40	192	10	25					24	26	2	4
	DN	M	21		35	213	6	45					19	31	2	9
	DS	F	17	230	13	42	41	116					4	5	5	22
<i>Euoticus elegantulus</i>	DU	M	18	270	19	41	40	123					8	5	6	26
	DW	M	19	340	12	30	36	129					4	3	6	21
	DX	F	18	320	15	36	33	128					6	4	5	27
	AY	F	19	230	20	85	8	51					8	11	2	9
<i>Galago alleni</i>	BC	F	18		21	112	8	50	3	5	1	4	9	13	1	6
	BC2	F	18	250	16	112	9	33	3	5	1	5	6	17	2	4
	ES	M	17	260	37	144	21	78					21	23	4	16
	AZ	M	11	48	6	24	3	5	0.4	0.5	0.1	0.3	1.5	1.0	0.2	0.3
<i>Galago demidovii</i>	BA	M	11	60	5	36	4	12	0.5	0.5	0.2	0.3	1.1	2.3	0.3	0.8
	BA2	M	12		5	34	5	14	0.6	0.7	0.2	0.4	1.0	1.8	0.4	1.1
	BB2	M	13		7	59	3	16	0.5	0.5	0.1	0.4	1.8	5.2	0.9	1.3
<i>Lepilemur mustelinus</i>	BF <sup>1</sup>	F	26		45	68	174	166					28	11	81	35
<i>Lepilemur leucopus</i>	DO	M	24	630	52	106	137	213					35	16	45	49
* * * * *																
<i>Loris tardigradus</i>	DI		22	230	19	85	4	42					8	10	3	6
<i>Microcebus murinus</i>			11		5	32	2	6								
<i>Perodicticus potto</i>	FM	M	31	1160	36	200	21	333					20	34	8	119
<i>Phaner furcifer</i>	DS	F <sup>1</sup>	20	270	14	95	43	130					5	28	6	27
New World monkeys																
<i>Saguinus geoffroyi</i>	BU <sup>2</sup>	F	23			113	8	57						19	2	11
	BV	M	24		19	150	14	67					8	36	3	15
	CA	F	23		66	157	14	72					50	38	4	21
	CH <sup>1</sup>	M	20	420	26	183	12	46					13	39	3	8
<i>Leontocebus midas</i>	BN <sup>2</sup>	M	25		13	116	6	23					4	19	1	3
<i>Aotus trivirgatus</i>	DA	F	28	970	84	288	47	120					72	61	22	37
<i>Saimiri oerstedii</i>	BX	M	30		61	308	16	53					45	70	4	14
	BY	F	28		49	342	18	48					32	103	4	12
	BZ	F	30		63	356	19	46					47	81	6	11
<i>Cebus capucinus</i>	CB	F	39		111	852	2	20								
<i>Cebus griseus</i>	BL <sup>2</sup>	M	40		68	462	4	38					53	106	6	6
	BM <sup>2</sup>	F	40		48	519	4	38					31	134	5	6
	PI2 <sup>1</sup>	M	41	1470	200	915	184	490	33	34	10	44	266	447	117	281
<i>Alouatta palliata</i>	CR	M	51		430	1052	289	1059					839	534	391	959
	BW	M	50		230	719	148	630					328	302	145	471
	BT	F	53		296	815	156	778					479	339	138	642
<i>Alouatta seniculus</i>	BK <sup>2</sup>	M	61		180	1106	150	578					227	556	163	422
<i>Lagothrix lagotricha</i>	P31 <sup>1</sup>	F	59	5670	264	2115	181	660	89	164	46	140	403	757	113	289
	P39 <sup>1</sup>	M	56	10430	488	1796	293	699	96	81	30	77	1014	693	228	442
<i>Ateles paniscus</i>	BO <sup>2</sup>	F	53		172	765	101	232					212	252	54	95

<sup>1</sup>Captive. <sup>2</sup>Fixed. <sup>3</sup>Immature.<sup>4</sup>Nos. AA, BA, etc. = C.M.H.; nos. PO1, DO1, etc. = D.J.C.

TABLE 6. Measurements of body length and weight, and of surface area, weight and volume of stomach, small intestine, caecum, and colon in Old World monkeys

Species	Ident. no. <sup>1</sup>	Sex	Body length, cm	Body weight, gm	Surface area, cm <sup>2</sup>				Weight, gm				Volume, cm <sup>3</sup>			
					Stom.	S.I.	Caec.	Colon	Stom.	S.I.	Caec.	Colon	Stom.	S.I.	Caec.	Colon
<b>Cercopithecine monkeys</b>																
<i>Miopithecus talapoin</i>	P13 <sup>1</sup>	M	38	950	59	451	40	212	7	26	2	16	43	96	16	76
	P37 <sup>1</sup>	F	28	880	64	594	30	258	4	26	1	12	48	142	12	106
	AM	F	30		59	157	26	214					43	14	18	81
	AO	F	29		44	149	25	87					27	18	12	20
	B1	M	24		49	231	12	122					32	34	4	32
<i>Cercopithecus cephus</i>	EM	F	42	2650	187	784	76	371					240	218	46	192
	EY	M	49	3800	70	446	45	325	13	15	5	30	55	71	18	129
	EZ	F	41	2400	144	582	60	458	27	18	10	43	163	107	48	220
	FD	M	54	4500	155	1008	56	877	37	81	17	86	181	321	83	572
<i>Cercopithecus neglectus</i>	EO	F	46	3850	206	710	83	827	61	49	12	132	278	260	69	605
	AR	F	46		144	556	69	728					163	132	47	444
	P28 <sup>1</sup>	M	58	11340	289	1382	77	982	61	100	11	119	460	448	43	518
<i>Cercopithecus nictitans</i>	AP	M	57		99	760	87	654					93	195	75	340
	AS	F	47		73	763	65	563					59	179	48	280
	AX2	M	58		177	798	95	753					221	214	80	410
	EL	M	59	6500	120	927	80	816	61	56	13	88	124	225	57	441
<i>Cercopithecus aethiops</i>	AB <sup>1</sup>	M <sup>2</sup>	37		34	169	13	143					19	17	3	35
	AC <sup>1</sup>	F <sup>3</sup>	40		14	234	31	105					5	42	15	25
<i>Cercocebus albigena</i>	AN	F	55		124	559	69	977					130	152	54	799
	AX	F	51		91	657	67	580					82	189	51	268
	FK <sup>1</sup>	M <sup>2</sup>	47	3700	88	453	20	374	24	51	6	62	78	108	8	164
<i>Macaca sylvana</i>	FN	F	51		270	1187	72	1323					416	434	46	954
	FO	F <sup>2</sup>	38		180	795	59	826					226	222	31	503
<i>Macaca mulatta</i>	P11 <sup>2</sup>		39	3350	77	618	81	377	15	56	13	32	64	160	47	123
<i>Macaca sinica</i>	DH	F	42		226	587	62	772					320	185	51	558
	DJ <sup>1</sup>	M	47		122	638	25	310					127	191	9	125
<i>Macaca fascicularis</i>	P29	M	37	2700	143	1011	28	693	15	22	3	31	160	346	8	364
	P45	M	40	3900	306	918	29	659	32	70	9	66	502	268	8	320
	P46	F	40	3050	178	1144	67	866	37	56	8	73	223	390	40	568
	*	*														
	*	*														
<i>Papio sphinx</i>	FK	M	72	16600	402	2854	64	1894					760	1596	47	1518
	EP	F	51	6100	250	1143	50	1228	76	97	13	163	372	409	33	1395
	FR	F	63	12300	322	2435	70	2240	123	296	13	332	543	968	195	1782
<i>Papio papio</i>	AF <sup>1</sup>	F <sup>2</sup>	29		20	173	4	67					8	19	1	11
<b>Colobine monkeys</b>																
<i>Colobus polykomos</i>	AQ	F	56		1021	556	26	549					2055	107	13	218
	FB	F	58	6500	1056	925	15	630	154	149	5	72	2162	184	6	301
<i>Presbytis entellus</i>	DF	M	63		1585	1673	105	978					3974	633	80	845
	DL	M	65	10000	1439	1167	140	760					3438	330	104	505
<i>Presbytis senex</i>	DG	F	48		938	740	139	548					1814	181	77	275
	DM	M	59		1416	687	139	548					3357	162	96	336
<i>Presbytis cristata</i>	P30	F	50	6850	1694	1929	90	966	265	60	9	99	4831	604	64	645
	P33 <sup>1</sup>	F	53	5440	1175	1329	30	607	182	65	5	59	2209	385	12	285
<i>Presbytis obscura</i>	P18	M	50	7960	1363	1953	64	670	180	77	8	66	3237	699	41	343
	P19	F <sup>3</sup>	45	4230	956	1311	52	558	105	53	4	42	1788	397	27	264
	P26	M	53	7200	1351	1969	88	902	154	62	6	76	2974	734	51	588
	P32 <sup>1</sup>	F	56	6350	1282	1129	90	869	211	45	8	50	3139	327	64	546
<i>Presbytis melalophos</i>	P14	M	51	6860	1020	1386	60	532	114	82	6	52	2072	336	34	156
	P16	M <sup>2</sup>	44	5220	694	1075	23	369	109	76	3	44	1128	247	8	132
	P17	F	47	6410	1648	1796	60	552	145	107	6	63	3521	517	36	224
	P22	M	49	6510	1078	1389	42	695	90	50	4	42	2158	395	20	362
	P23	F	50	7340	1382	1695	68	848	124	71	8	50	3327	588	43	469
	P24	F	52	6880	1274	2021	38	612	150	60	7	71	2296	633	14	292
<i>Presbytis rubicunda</i>	P38 <sup>1</sup>	M	56	6350	1125	1672	45	637	105	21	7	38	2259	505	20	329
<i>Nasalis larvatus</i>	P25 <sup>1</sup>	M	64	15880	1978	3120	100	1234	357	153	6	82	6523	1127	66	655
<i>Pygathrix nemaeus</i>	P34 <sup>1</sup>	F	53	4540	1243	1512	36	578	137	63	5	50	2960	444	12	261
	P30 <sup>1</sup>	F	60	3630	1431	1601	80	854	200	47	4	45	3442	531	42	433

<sup>1</sup>Captive. <sup>2</sup>Fixed. <sup>3</sup>Immature.  
Nos. AA, BA, etc. = C.M.H.; nos. PO1, OO1, etc. = D.J.C.

TABLE 7. Measurements of body length and weight, and of surface area, weight, and volume of stomach, small intestine, caecum, and colon in apes, domestic mammals and temperate wild mammals

Species	Ident. no. <sup>1</sup>	Sex	Body length, cm	Body weight, gm	Surface area, cm <sup>2</sup>				Weight, gm				Volume, cm <sup>3</sup>			
					Stom.	S.I.	Caec.	Colon	Stom.	S.I.	Caec.	Colon	Stom.	S.I.	Caec.	Colon
<b>Apes</b>																
<i>Hylobates lar</i>	P05 <sup>2</sup>	M	40	5000	204	453	15	383	58	81	4	74	274	154	3	259
	P06 <sup>2</sup>	F	40	5400	104	268	6	403	53	35	2	68	100	68	2	267
<i>Hylobates pileatus</i>	P41 <sup>1</sup>	F	47	7260	304	592	77	1128	56	77	17	144	499	596	34	920
<i>Hylobates syndactylus</i>	P27 <sup>1</sup>	F	52	11340	457	2278	75	1557	146	150	10	230	919	1007	34	1891
	P40 <sup>1</sup>	M	56	7250	140	1708	81	954	55	183	22	184	156	697	58	883
<i>Pongo pygmaeus</i>	P42 <sup>1</sup>	M	61	8620	256	1263	70	978	71	124	17	157	385	461	56	1071
	P35 <sup>1</sup>	M	95		880	6564	155	5774	331	568	22	980	2457	4046	55	7800
<i>Pan troglodytes</i>	AD <sup>1</sup>	F	83		472	1700	162	1812					965	815	91	1451
	EN	M	72	34000	690	3761	286	2925					1705	1967	407	4335
<i>Pan gorilla</i>	EQ	M	84	51000	1087	4018	590	4813					3370	1897	955	7006
<b>Domestic mammals</b>																
<i>Felis</i> (cat)	D09	M	45	4000	144	345	8	125	24	104	1	17	163	60	2	48
	D12	F	40	2450	104	249	7	87	20	67	1	14	100	36	1	25
	D13	M	43	2730	120	372	9	123	16	84	1	17	124	71	2	40
	D18	F	42	2450	106	348	12	148	17	42	1	11	102	75	3	62
	D19	F	42	2700	132	374	11	130	21	43	1	11	143	86	3	52
	D20	M	46	4340	117	291	8	111	24	60	1	13	119	41	2	36
<i>Canis</i> (dog)	D03	M	78	13500	300	1030	40	225	133	263	8	42	490	238	16	90
	D04	M	59	7250	215	585	30	125	46	125	5	30	297	102	8	43
	D05	F	60	10680	426	992	37	208	109	198	8	42	826	253	11	75
	D06	F	58	9400	196	562	25	75	52	130	4	26	258	136	10	20
	D21	F	81	12550	344	1445	40	192	153	327	6	53	599	483	16	61
	D24	F	48	4750	162	776	20	135	48	170	7	24	194	196	5	54
<b>Sus</b>																
<i>Sus</i> (pig)	D27	M	54	7650	381	1057	30	170	107	285	14	35	701	294	10	58
	D29	M	55	7450	193	656	30	132	71	178	5	23	253	193	10	45
	D30	M	55	7950	216	696	30	99	68	163	5	21	297	166	10	35
	D15	M	98	47980	160	14425	440	4702	333	1144	70	685	1597	9119	700	3710
	D41		126	65320	917	9968	432	6246	464	1010	78	984	2610	4828	619	5855
	D42		123	60780	792	14036	630	6824	332	1327	128	1106	2097	7420	902	6042
<i>Equus</i> (horse)	D14	M	157	202730	728	10991	9240	27993	675	3204	1395	5450	1847	6207	28296	50551
<i>Capra</i> (goat)	D01	M	127	84950	31297	8967	300	5131	2250	710	67	585	16220	2924	286	2452
	D02	M	145	94220	36475	11948	437	6047	3210	950	98	878	20878	4277	282	3339
	D33	M <sup>3</sup>	84	21900	15029	6102	275	1830	686	607	27	186	6317	1747	273	592
	D34	M <sup>3</sup>	82	23850	13195	4901	187	1601	671	579	33	241	5086	1208	164	467
<i>Ovis</i> (sheep)	D43		104	40820	14110	15780	490	3642	1062	925	61	384	7989	6414	530	1587
	D44		99	47170	13760	10591	403	2496	1093	868	58	393	7568	3496	461	533
	D45		99	38100	11702	10299	150	2066	959	798	57	368	8040	3523	119	701
<b>Wild mammals (temperate)</b>																
<i>Oryctolagus cuniculus</i>	MB		43	2600	157	958	529	431					185	214	353	117
<i>Sciurus vulgaris</i>	D47	M	24	600	26	307	54	136	5	9	3	4	13	43	29	30
<i>Mustela nivalis</i>	D38		18	140	30	131	0	12					16	19	0	2
<i>Mustela erminea</i>	D39		24	30	42	121	0	19	2	5	0	1	26	13	0	2
<i>Vulpes vulpes</i>	D37	M	64	8000	406	929	48	229	78	106	4	25	768	329	23	91
	D46	F	65	5500	308	993	75	336	50	122	5	21	508	372	30	204
	D48	M	52	6250	320	992	56	232	68	130	7	27	538	329	18	100
	D49	F	58	5750	352	854	48	279	57	104	5	28	621	302	15	151
	D50	M	56	6200	259	929	54	236	60	105	5	26	392	340	19	117
<i>Phocaena phocaena</i>	D35	M	130	29030	1151	11213	11213	11213	462	1125			3672	6831		
	D36	F			1501	21309	21309	21309	636	1928			5471	18733		
	D40		168	50450	1501	12455	0	53	885	1333	0	9	5471	9257	0	25
<i>Tursiops truncatus</i>	D51		230	450000 ca	1588	25540	0	389	200	430	10	10	3701	20913	0	208

<sup>1</sup>Captive. <sup>2</sup>Fixed. <sup>3</sup>Immature.<sup>3</sup>Nos. AA, BA, etc.: C.M.H.; nos. P01, D01, etc. = D.J.C.



TABLE 8. Measurements of body length and weight, and of surface area, weight, and volume of stomach, small intestine, caecum, and colon in nonprimate tropical mammals

Species	Ident. no. <sup>1</sup>	Sex	Body length, cm	Body weight, gm	Surface area, cm <sup>2</sup>				Weight, gm				Volume, cm <sup>3</sup>			
					Stom.	S.I.	Caec.	Colon	Stom.	S.I.	Caec.	Colon	Stom.	S.I.	Caec.	Colon
Wild mammals (tropical)																
<i>Atilax paludinosus</i>	MW	F	45	2380	70	575	9	74	31	86	3	19	55	124	4	21
<i>Potamogale velox</i>	MX		23	740	19	368	0	39	4	22	0	4	8	67	0	11
<i>Manis tricuspis</i>	ME		28	1550	189	517	0	134					245	85	0	55
<i>Manis gigantea</i>	MR	M <sup>2</sup>	23	1950	39	615	0	50	12	34	0	11	23	73	0	10
<i>Epixerus ebii</i>	MG	M	24	580	30	201	21	52	4	6	2	4	16	22	5	6
<i>Heliosciurus rufobrachium</i>	MI	F	23	540	48	216	21	68	5	6	1	4	31	26	6	12
<i>Funisciurus anerythrus</i>	MH	M	20	290	51	190	48	63	6	4	3	3	34	25	11	8
<i>Funisciurus pyrrhopus</i>	MK				16	161	15	30	3	5	1	2	6	18		
<i>Anomalurus fraseri</i>	ML				18	268	16	48	7	10	1	3	7	25	3	7
<i>Eidolon helvum</i>	MT <sup>3</sup>		24		10	216	90	93	5	9	7	5	3	34	22	11
<i>Dendrohyrax dorsalis</i>	MF	F	14	190					2	4	0	2				
	MC	<sup>3</sup>	40	1405	114	311	350	335					81	48	196	74
	MO	F	39	2323	140	456	482	572	54	25	61	43	110	73	331	169
	MP		38	2066	120	391	393	549	44	29	48	33	86	53		129
	MU	F	31	1415	143	315	275	304	25	17	30	12	114	55		80
	MV	M	44	2720	126	588	362	594	54	40	60	44	94	131		156
<i>Nandinia binotata</i>	MD	F	42	2400	143	481	0	150					160	142	0	53
	MY	M	45	2250	105	420	0	98	34	65	0	23	101	100	0	27
	NA	M	43	2440	60	209	0	73	22	38	0	16	43	37	0	15
<i>Bradypus tridactylus</i>	MA		46		601	411	0	262					986	97	0	88
<i>Poiana richardsoni</i>	MS		29	510	36	184	1	27	11	17	3	4	20	28	1	6
<i>Genetta servalina</i>	MQ		50	1480	63	274	2	48	19	54	5	15	47	42	3	15
<i>Profelis aurata</i>	MZ	F <sup>3</sup>	57	5230	134	404	2	92	58	130	1	26	120	88	1	32
<i>Panthera pardus</i>	MM	M <sup>3</sup>	84	15700	421	1580	22	342	131	392	4	61	813	593	10	163

<sup>1</sup>Captive. <sup>2</sup>Fixed. <sup>3</sup>Immature.  
<sup>4</sup>Nos. AA, BA, etc. = C.M.H.; Nos. P01, D01, etc. = D.J.C.

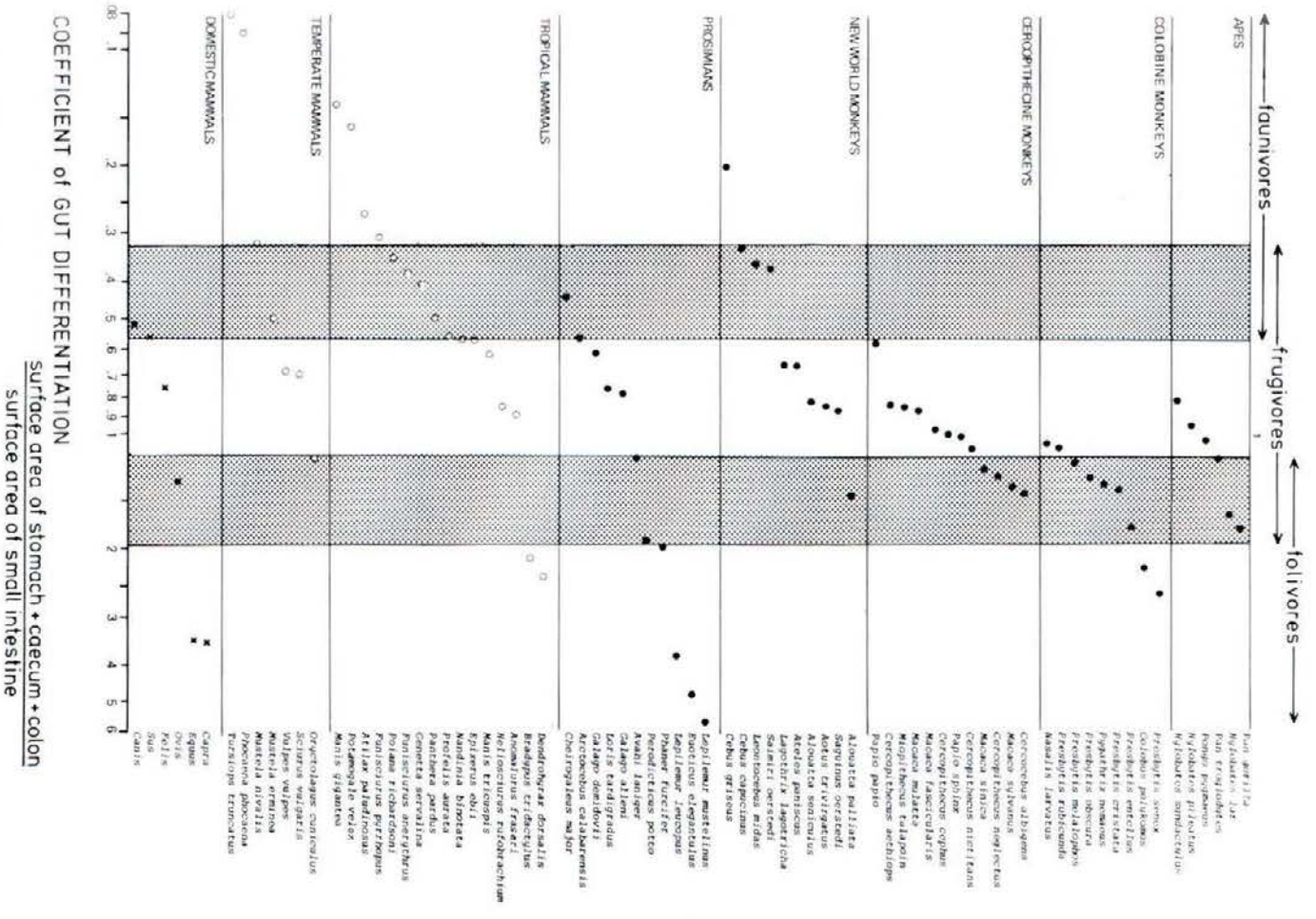

Fig. 18. Coefficients of gut differentiation from surface area reorganized into taxonomic groups for primates and ecologic groups for other mammals, with the limits of morphological dietary categories marked approximately by the vertical stippled zones.

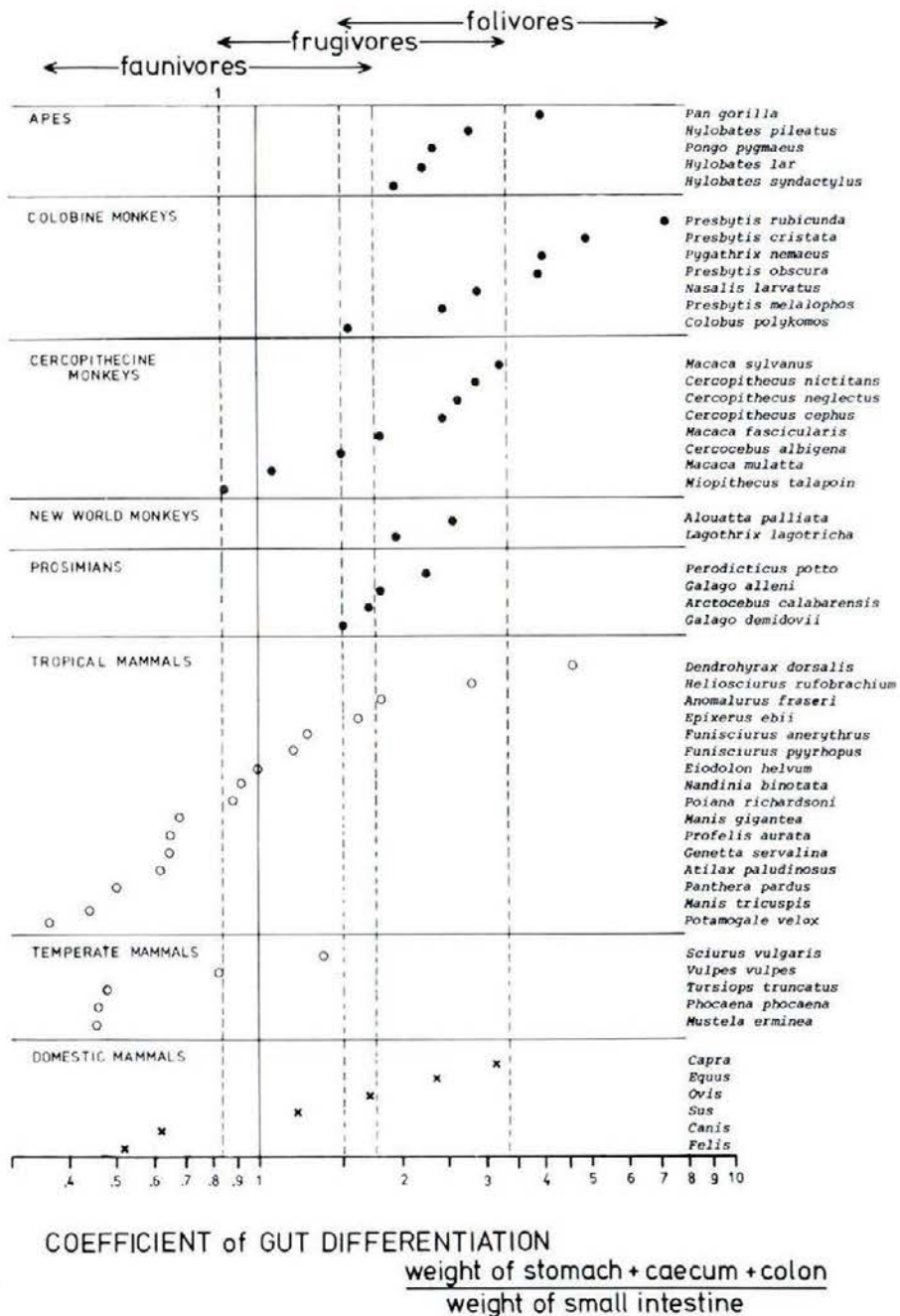

Fig. 19. Coefficients of gut differentiation from weight in each taxonomic group of primates, in other temperate and tropical mammals, and in domestic mammals, indicating the extent and overlap of the main morphological dietary categories by vertical broken lines.

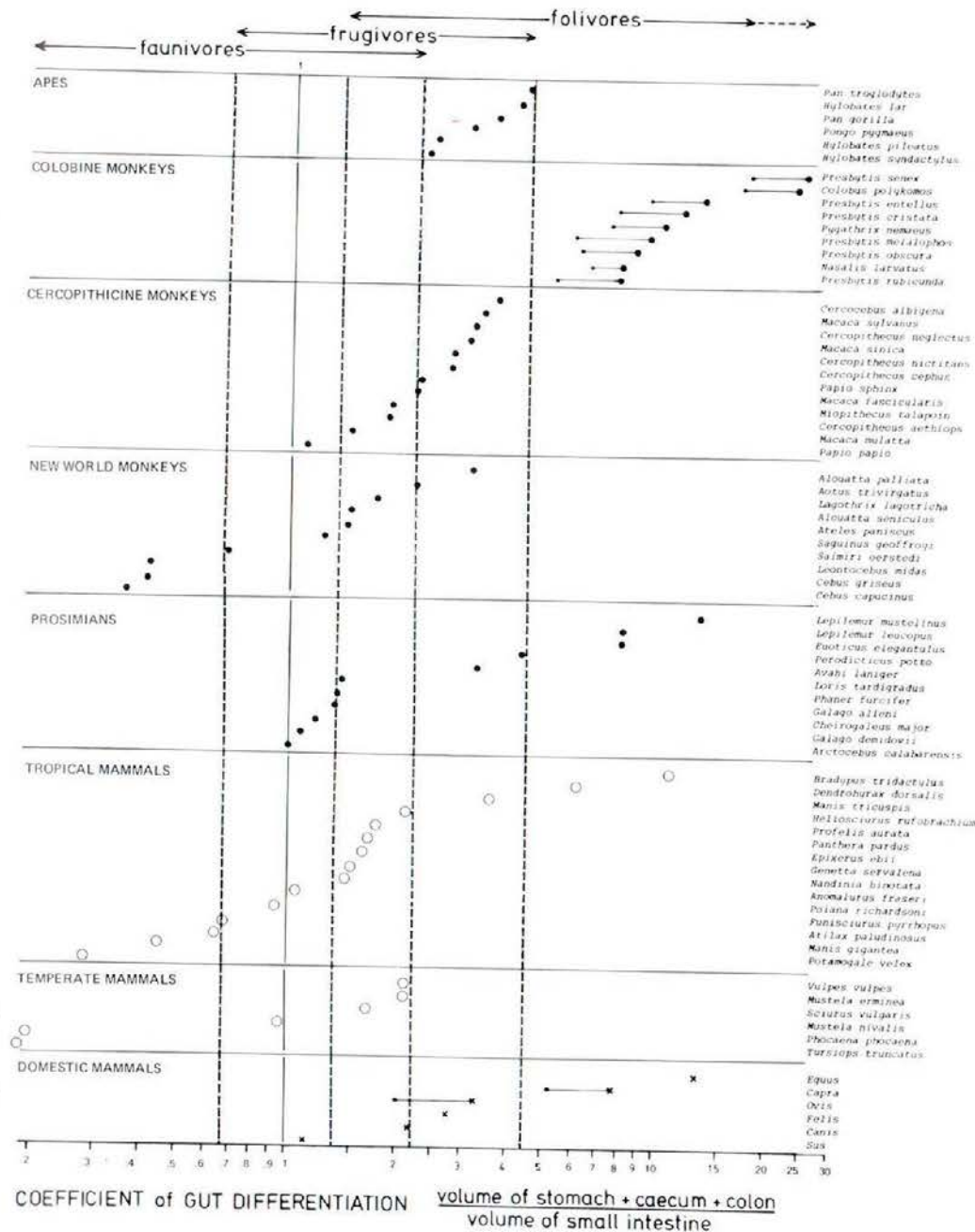

Fig. 20. Coefficients of gut differentiation from volume in each taxonomic group of primates, in other temperate and tropical mammals, and in domestic mammals, indicating the extent and overlap of the main morphological dietary categories. The distortion of values for colobine monkeys and domestic ruminants, resulting from the standard treatment of stomachs as spherical, is corrected as outlined in table 4 and plotted as a small closed circle to the left of the standardized value; in the case of primates it leads to a closer relationship with other primates, but it disrupts the sequential pattern among domestic mammals.

While surface areas are taken as critical for pinpointing differences in digestive and absorptive functions between species, weights of each region provide an indication of the amount of muscle, and thus of physical activity in that region. In each mammalian group such data as are available provide a clear contrast between those faunivorous mammals with a relatively heavy small intestine, and those folivores with a heavy stomach and/or large intestine (Fig. 19). Comparing groups, however, we find different values for dietary boundaries (except for folivores), so that the overall spread of faunivores overlaps slightly with that of folivores, thereby obscuring frugivores as a group.

Volumes are most significant with reference to the capacity of those parts of the tract concerned with fermentation; it is presumed that the larger the volume, the more fermentation can take place. The extensive overlap of coefficients between dietary categories, reflecting wide variation in the relative volumes of different parts of the gut, may make this parameter the least accurate indicator of diet (Fig. 20). This would be because complexities of function cannot be accounted for when comparing directly the volumes of mainly fermenting and mainly absorbing regions in this way.

Initially, stomachs were treated as spheres and volumes were calculated accordingly from surface areas, as described above, thereby standardizing interspecific comparison. Corrections according to the shape of each chamber in complex stomachs gives a more accurate figure and a more precise indication of the dietary adaptation of the species concerned. Discrepancies between different methods of calculating stomach volume are small compared with the differences between species.

In a fermenting chamber the corresponding area for absorption should vary according to the two-thirds power of the volume. Since absorption is an important function irrespective of diet, there should be a compromise between large volume and reduced surface area in the fermenting chambers of the more efficient consumers of grasses and leaves. In different species the presence of sacculations, folds, papillae, villi, and microvilli changes the relationship. In our measurements we could account only for the larger features; e.g., in ruminants such as the goat, papillae increase the surface area of the rumen eight-fold, "leaves" quadruple the area of the omasum, and folds double the area of the abomas-

um (Fig. 16). Such features also affect the weight of the organ. Similarly, villi increase the surface area of the mucosa of the small intestine by similar proportions, although there is considerable interspecific variation (Hladik, 1967); at this level of analysis no correction is thought necessary, but further studies are in progress. Nevertheless, these crude areal measures seem to provide the best indicators of dietary adaptation.

*Allometric Relationships.* To compare the dimensions of the gastro-intestinal tract and its component parts between species, an allometric correction must be introduced in relation to body weight or some other measure of body size. In the field it was easier to measure accurately the length rather than the weight of the specimen; in any case, the latter is more susceptible to changes in individual condition. The value of the constant of proportionality is determined by the shape of the body (McMahon, '73), which is fairly homogeneous among primates, and not very different in the other terrestrial mammals. Furthermore, the use of values derived from length are not distorted by nonmetabolic components of weight, such as fat, which are irrelevant to allometric considerations (Schmidt-Nielsen, '72).

The volumes of potential fermenting chambers (the sum of values for stomach, caecum, and colon) in each species are displayed on a logarithmic scale in relation to body size (taken as the cube of body length, as a measure related directly to weight) (Fig. 21). The regression of these volumes ( $V$ ) on body size ( $L^3$ ) in 73 species, using the means for those with more than one specimen, is represented by the equation:

$$\log V = 1.02 \log L^3 - 2.69 \quad (r = 0.83, p < 0.001)$$

The large scatter, reflected by the low value of  $r$ , is not surprising since species differing markedly in diet are grouped together. The slope of the regression equation is close to 1.0, which means that the volume for fermentation appears at first approximation to be proportional to body size. Parra ('78), when comparing the size of fermenting chambers in ruminants and nonruminants, obtained a slope of 1.1 and suggested that the relative capacity of fermenting chambers increased with body size.

The relationship between the volume of fer-

menting chambers and body size can be illustrated by cubic models of animals of length  $L$  and volume  $L^3$  (Fig. 24). The fermenting chambers are required to fill this volume with nutrients each day; this will be achieved if the size of the fermenting chamber is proportional to the size of the animal. However, this intake of nutrients relates to metabolic weight, which only increases to the three-quarter power of body weight (Schmidt-Nielsen, '72), that is,  $L^{2.25}$  in our model. Furthermore, Tucker ('70) calculated that the energetic costs of movement in terrestrial mammals are relatively smaller in larger forms. In the arboreal environment of most primates, however, costs might be much higher for larger species, because they are theoretically proportional to actual body weight (or  $L^3$ ) for all vertical movements. Thus the correcting factor for gut volume to account for eco-physiological needs in relation to body size should lie between  $L^{2.25}$  and  $L^3$ , slopes of 0.75 and 1.00 respectively in the log/log graph.

If animals with similar diets are considered together, the wide scatter of plots (Fig. 21) is resolved into meaningful components (Fig. 22). Thus, reliable data on the volumes of potential fermenting chambers from mature wild mammals are regressed linearly against body size in four groups:

1) in 30 faunivores of 14 species, from 11 to 230 cm body length,

$$\log V = 0.95 (\pm 0.11) \log L^3 - 2.52 \quad (r = 0.95, p < 0.001);$$

2) in 50 frugivores of 22 species, from 17 to 126 cm body length,

$$\log V = 1.13 (\pm 0.12) \log L^3 - 2.94 \quad (r = 0.92, p < 0.001);$$

3) in 13 folivores of seven species, with large caecum and colon, from 17 to 157 cm,

$$\log V = 1.20 (\pm 0.08) \log L^3 - 2.95 \quad (r = 0.99, p < 0.001); \text{ and}$$

4) in 14 folivores of six species, with large stomachs, from 44–145 cm body length,

$$\log V = 0.78 (\pm 0.09) \log L^3 - 0.69 \quad (r = 0.97, p < 0.001).$$

For each of these equations the 95% confidence intervals were calculated according to standard practice (Moore et al., '72); those for the

different dietary groups are clearly separated (Fig. 22). The differences between the slopes in the equations for folivores with large colon and faunivores are also significant ( $p < 0.05$ ).

In faunivores, where fermentation is minimal, the volumes of these parts of the gut are related mostly to actual body weight (expressed as  $L^3$ ). In frugivores and folivores with large caecum and colon the potential fermenting chambers are relatively more voluminous in larger animals; the wider scatter among frugivores seems to reflect the inclusion of species consuming significant amounts of either animal or plant matter in addition to fruit. The folivores with large stomachs are remarkable in that the sizes of potential fermenting chambers are relatively much smaller in larger animals; compared with the other three groups, this represents a more efficient adaptation to metabolic needs, since the slope of regression is close to the theoretical 0.75.

Although there is a close correspondence between fermenting volume and body size across the two types of folivore, as shown by the crossing and lack of much divergence of the respective regressions (Fig. 22), the significant difference in slopes reflects the different allometric relationships of the two distinctive strategies of fore-gut and mid-gut fermentation (in stomach and caecum/colon respectively). Structurally this is a matter of "sacs" (spheres) versus "tubes" (cylinders). The "sac" is ideal for fermentation, but it must be kept relatively small in the larger fore-gut fermenters, so as to provide adequate area for absorption; they have a relatively larger small intestine to complete this process (see below). In contrast, the larger mid-gut fermenters require an extended, thus more voluminous, "tube" for adequate absorption; area and volume do not diverge so rapidly with increasing size of cylinder, as they do with spheres.

This leads directly to a consideration of absorptive activity within the gastro-intestinal tract, which is concerned with surface area rather than volume. It is our initial assumption, based on evidence from man, rhesus monkey, and dog (Bell et al., '63; Kayser, '63) that the small intestine is the most important region for absorbing the products of digestion. Thus, to seek allometric relationships, the values for the surface area in each species are plotted against body size on a logarithmic scale (Fig. 23). The linear regression of these surface areas ( $A$ ) in relation to body size ( $L^3$ ), using means for those of the 76 species for which there is more than one specimen, is

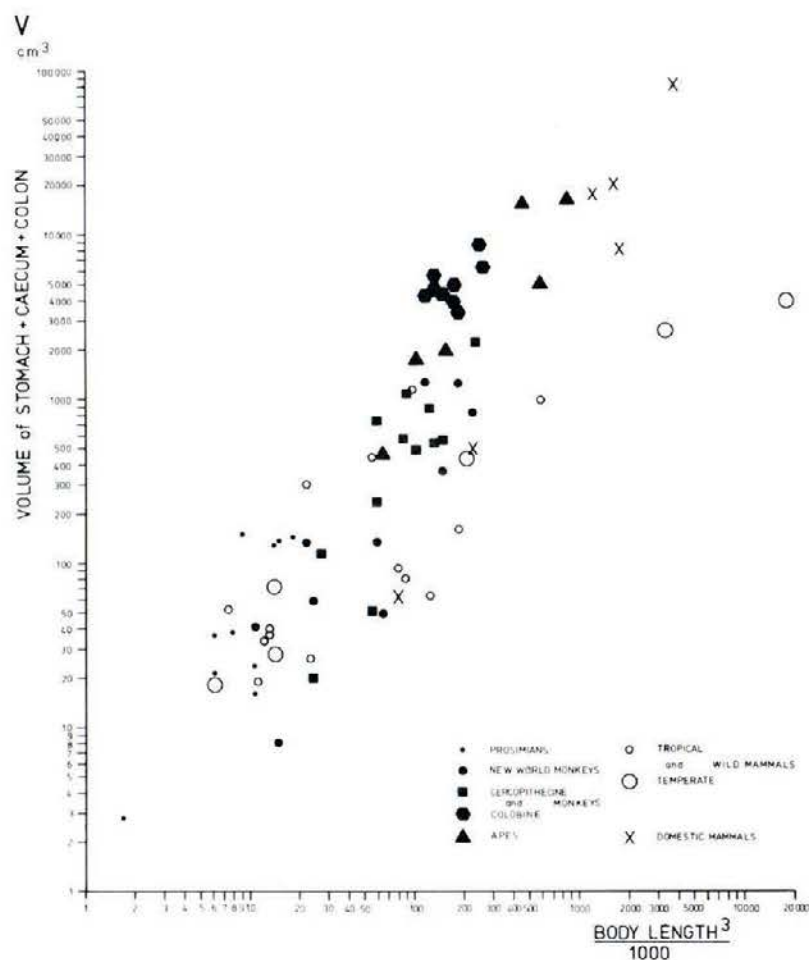

Fig. 21. Volumes of potential fermenting chambers plotted against body size (from body length, cm) for each species, using mean values where there is more than one specimen.

represented by the equation:

$$\log A = 0.76 \log L^3 - 0.96 \quad (r = 0.93, p < 0.001).$$

The scatter is less than that for volume (Fig. 21). The slope of 0.76 would mean that the area for absorption is proportional to metabolic rather than overall body size (see below for discussion of confidence intervals).

Returning to the cubic model of animals of varying length  $L$  and volume  $L^3$  (Fig. 24), relationships between surface area and absorption can be described. If flow across the mucosa occurs at a constant rate, because of similar histology, the surface area of gut required to fill the animal at a rate of  $1,000 \text{ cm}^2/\text{day/cm}^2$  will be 0.001, 1, and  $1,000 \text{ cm}^2$  respectively for the three animals. Because animals of different sizes have different basal

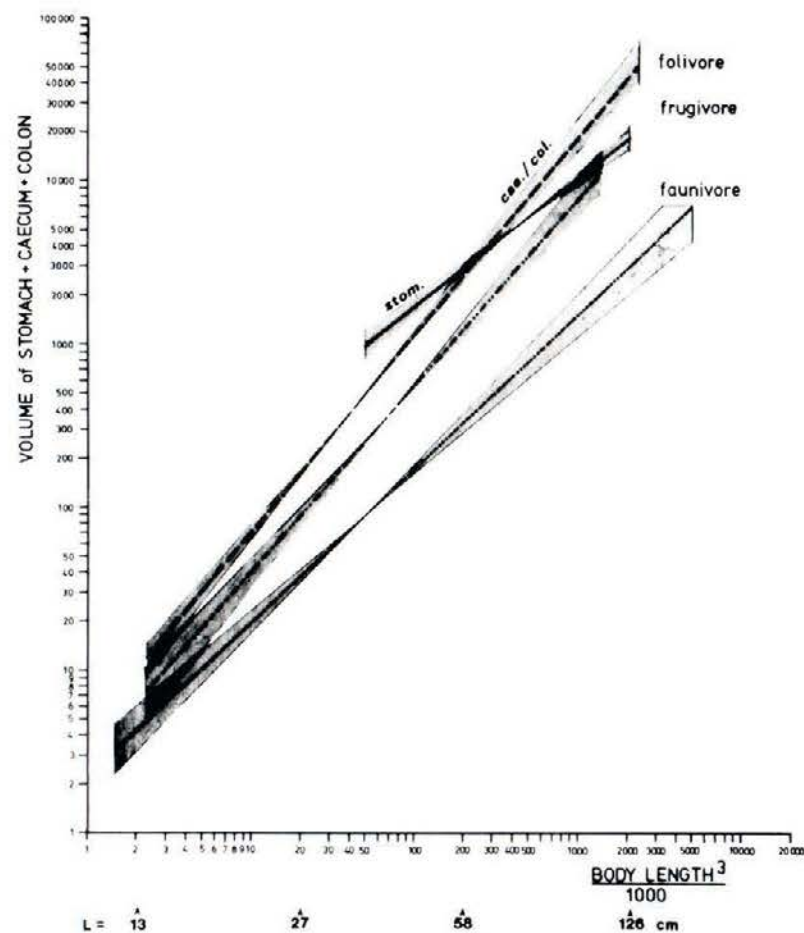

Fig. 22. The relationship between the volume of potential fermenting chambers and body size in faunivores, frugivores, folivores with large stomachs (stom.), and folivores with large caecum and colon (cae.col.), in the form of regressions derived from individual data, with the shaded areas demarcating the 95% confidence limits for the slopes.

metabolic rates (BMR), however, the volumes to be filled are proportional to the three-quarter power of body weight— $L^{2.25}$  in our model—and the volume of nutrients absorbed in 1 day will be such that areas of 0.0056, 1, and  $178 \text{ cm}^2$  are required in the three animals respectively. It can be seen that there is a point beyond which further increase in body size is impossible, because of a prohibitive requirement for vast intestinal area.

Allowance must also be made for activity, which as mentioned above costs relatively more in terms of energy in a larger animal, despite an improved output. Thus the flow across the gut wall depends on a surface area of gut that relates to a value of body size somewhere between  $L^3$  and  $L^{2.25}$ . Although the correct factor to account for metabolic plus energetic costs with regard to absorptive area seems to fall in the same range as for fer-

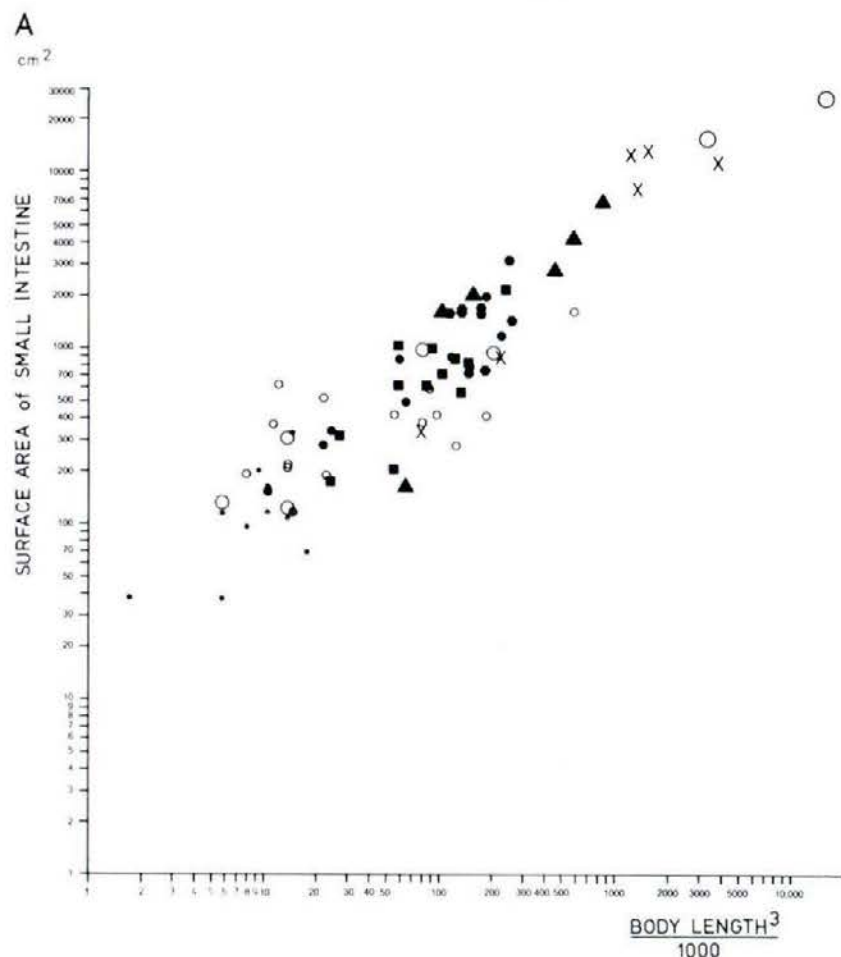

Fig. 23. Surface areas of the main absorbing region (small intestine) plotted against body size (from body length, cm) for each species, using mean values where there is more than one specimen.

menting volume, the nature of the relationship is different.

The relationship between the surface area of the small intestine and body size is clarified by regressing data for mature wild individuals in four groups (Fig. 25):

1) in 31 faunivores of 14 species,

$$\log A = 0.65 (\pm 0.07) \log L^3 - 0.54 \quad (r = 0.96, \quad p < 0.001);$$

2) in 51 frugivores of 23 species,

$$\log A = 0.75 (\pm 0.08) \log L^3 - 0.85 \quad (r = 0.92, \quad p < 0.001);$$

3) in 14 mid-gut fermenting folivores of 8 species,

$$\log A = 0.86 (\pm 0.15) \log L^3 - 1.46 \quad (r = 0.95, \quad p < 0.001); \text{ and}$$

4) in 14 fore-gut fermenting folivores of 6 species,

$$\log A = 1.16 (\pm 0.22) \log L^3 - 3.09 \quad (r = 0.94, \quad p < 0.001).$$

Thus, different patterns emerge; only frugivores follow the expectation of absorptive area being directly proportional to metabolic body

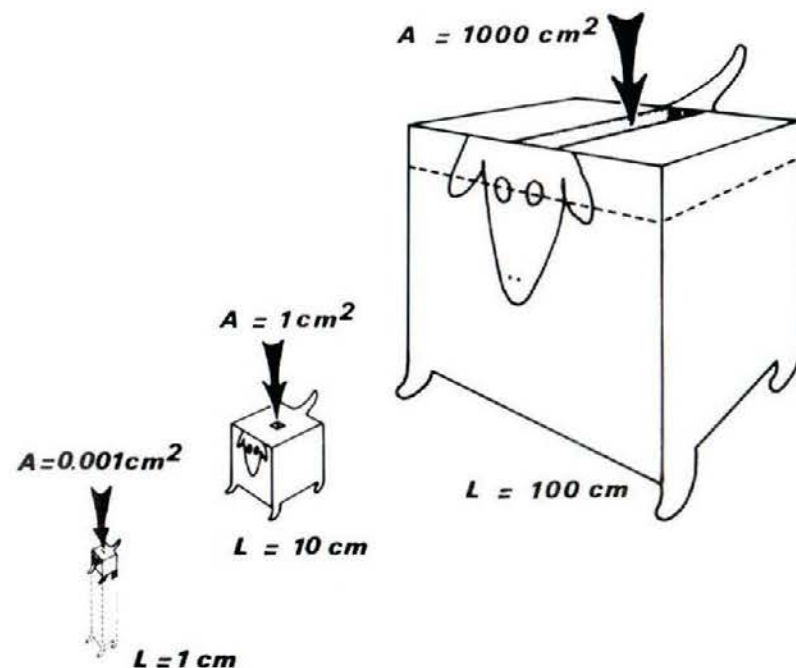

Fig. 24. Cubic models of body lengths 1, 10, and 100 cm, and theoretical weights .001, 1, and 1000 kg. The areas necessary to fill these models in unit time by constant flow (shown by openings in top) are .001, 1, and 1000 cm<sup>2</sup>. These are equivalent to the absorptive intestinal area. The actual volumes are .001, 1, and 1000 liters, but the "metabolic volumes" that actually have to be filled, with middle-sized model as reference, are .0056, 1, and 178 liters (shown by broken lines on the smallest and largest models). Thus, to maintain the constancy of the organism, and to fill the different volumes in the same time, the absorptive intestinal areas must be .0056, 1, and 178 cm<sup>2</sup>.

size (in log values), but they have the widest scatter (for the reasons mentioned previously). Faunivores have relatively less small intestine when larger, whereas the larger the folivore, especially the fore-gut fermenters, the larger the small intestine relative to body size.

Correlations within each group, however, are less close than in the analysis of volumes, and calculation of the 95% confidence intervals produces extensive overlap between the different regression lines. The most obvious explanation is that it is erroneous to assume that absorption of nutrients occurs only in the small intestine, especially in folivores and frugivores with a significant intake of leaves.

There is a mounting body of evidence that the large intestine in particular does much more than regulate water and electrolytes (Sineshchekov, '65; Giesecke, '69; Kay and Pfeffer, '69; Parra, '78).

Accordingly, after testing different combinations of areal proportions, so as to account to some extent for the absorption that occurs in stomach, caecum, and colon, the best fit in regression was obtained by adding half the combined area of these regions to the area of small intestine. Since the actual efficiency of absorption has not been measured in most species, we have to rely on this arbitrary choice. The resulting linear regressions of this

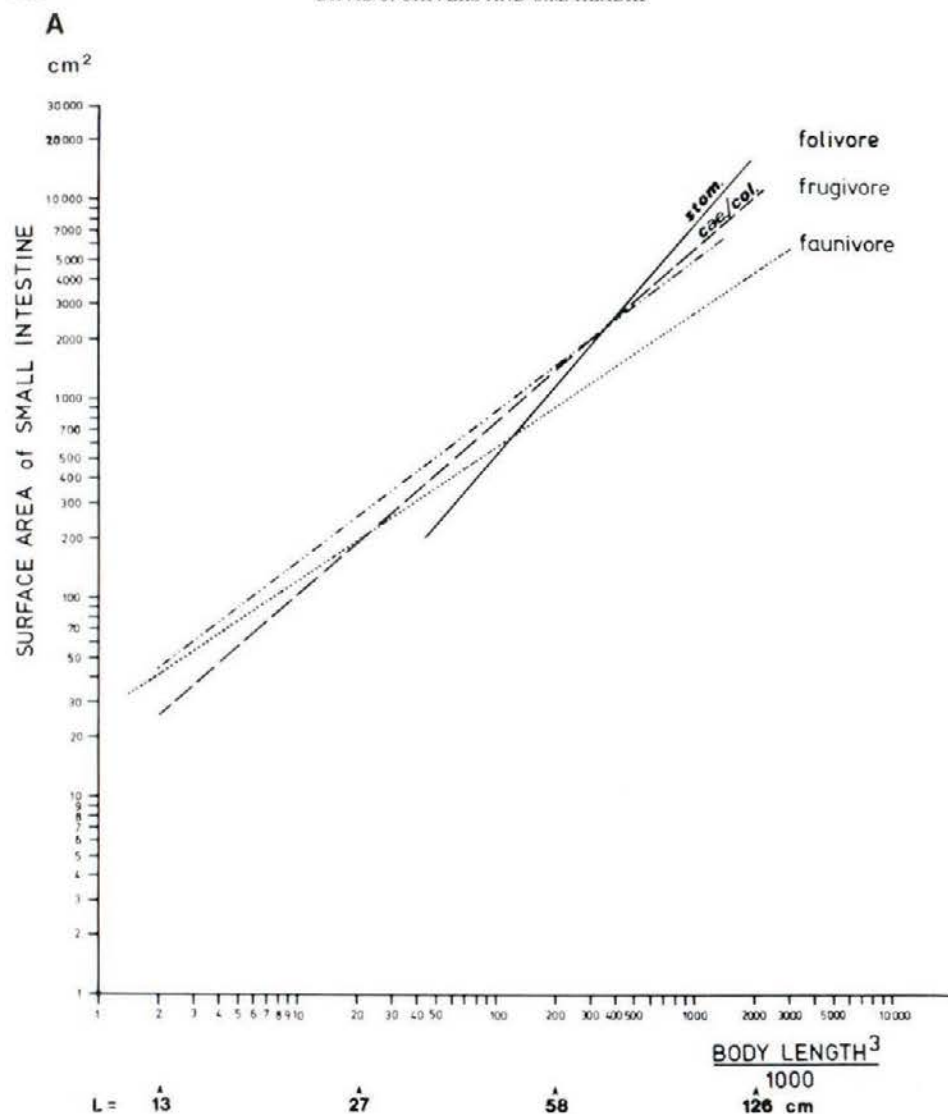

Fig. 25. The relationship between the surface area of the main absorbing region (small intestine) and body size (from body length, cm) in faunivores, frugivores, folivores with large stomachs (stom.), and folivores with large caecum and colon (c./col.), in the form of regressions from individual data. The 95% confidence intervals would show extensive overlap.

"absorptive area" ( $A'$ ) and body size ( $L^3$ ) in the four groups are:

1) in 32 animalivores of 16 species,

$$\log A' = 0.66 (\pm 0.06) \log L^3 - 0.48 \quad (r = 0.96, p < 0.001);$$

2) in 46 frugivores of 21 species,

$$\log A' = 0.79 (\pm 0.09) \log L^3 - 0.88 \quad (r = 0.95, p < 0.001);$$

3) in 8 mid-gut fermenting folivores,

$$\log A' = 0.86 (\pm 0.15) \log L^3 - 1.46 \quad (r = 0.95, p < 0.001); \text{ and}$$

4) in 14 fore-gut fermenting folivores,

$$\log A' = 1.19 (\pm 0.17) \log L^3 - 2.97 \quad (r = 0.96, p < 0.001).$$

These regressions now have a better fit (higher value of  $r^2$ ). Since values for the two folivore groups overlap each other extensively, the regression was applied to the total set of data. Thus, for 38 folivores of 16 species,

$$\log A' = 0.88 (\pm 0.06) \log L^3 - 1.17 \quad (r = 0.97, p < 0.001).$$

In the three dietary groups characterized by these equations (Fig. 26), the 95% confidence intervals have been calculated; they show no overlap except for animals of very small body weight, because of the convergence of the three lines. This latter feature suggests that smaller animals show similar structural adaptations for absorption, irrespective of diet.

The maximum and minimum values of the slopes of these regressions have been compared in terms of 95% confidence intervals. They differ significantly between folivores and faunivores, but frugivores differ from these two extremes at only the 85% limit. This lack of high significance is not surprising, since the frugivore sample comprises species with rather different diets based on fruit. Both frugivores and folivores fall within the limits derived for metabolic plus energetic requirements (slopes between 0.75 and 1.00). Faunivores, on the other hand, with a slope of 0.66 (less than 0.50 for a small set of highly specialized faunivores), in their larger forms fall below the value expected for absorptive intestinal area. These large faunivores usually catch very large prey at irregular intervals, which provide ample rich food spasmodically. Such food is digested during long periods of rest, and a smaller intestine is adequate, because of the extra time available for absorption. Conversely, small faunivores, relying mainly on invertebrates, have access to a more regular supply of food, which corresponds to the eco-physiological patterns of the other dietary groups.

The significant difference in the slopes of regression for each dietary category do not allow the use of a single allometric factor. Such a factor would have been invaluable in interspecific comparisons independent of body size, as was attempted above with indices of gut differentiation. The results of the relation

between body size and the potential area for absorption (Fig. 26) show that this area must be divided by  $L^{1.98}$  in faunivores, by  $L^{2.37}$  in frugivores, and by  $L^{2.61}$  in folivores, in order to eliminate allometric factors and validate the comparison between species. The factor  $L^2$ , used in earlier studies to compare gut surface areas (Hladik, '67), was a good approximation (apart from being below the theoretical range from  $L^{2.25}$  to  $L^3$ ), but it can now be seen as valid only for faunivores and some frugivores.

The ultimate aim in our studies of gut morphology has always been to seek correlations with diet. The results presented in this section advance considerably our understanding of the morphological features relevant to diet in the different dietary groups, and show how each achieves the necessary compromise between adequate volume for fermentation and adequate surface area for absorption. Of the approaches adopted, however, the first did not yield conclusive ratios of gut differentiation, probably through ignoring allometric factors, and the second, accounting for such factors, did not yield a single morphological index directly comparable with diet. So far we have been considering diet from the morphological viewpoint, and before concluding the search for a single morphological index, some features of diet and feeding behavior need first to be stressed.

#### DIET IN RELATION TO GUT MORPHOLOGY

The diets of most species, especially primates, are composed of varying combinations of each major category of food—animal matter, fruit, and leaves. This is well known from field studies and partly explains the scatter of morphological plots in the preceding analysis, mostly among frugivores. While recognizing the special significance of the gross dietary categories to which each species can usually be assigned, particularly the most specialized forms, we have tried to avoid any implication that a classification into faunivores, frugivores, and folivores reflects exclusive diets.

In comparing the diets of wild mammals, even among closely related forms, we immediately encounter problems resulting from different methods of both observation and analysis. Observations may be made continuously, or sampled at intervals of varying duration, over periods that vary from a few hours to several days. Food intake may be assessed in gross terms or in fine detail, either from direct observation or even from analyzing stomach contents or faeces. The difficulties are compounded when such variable data are subject-

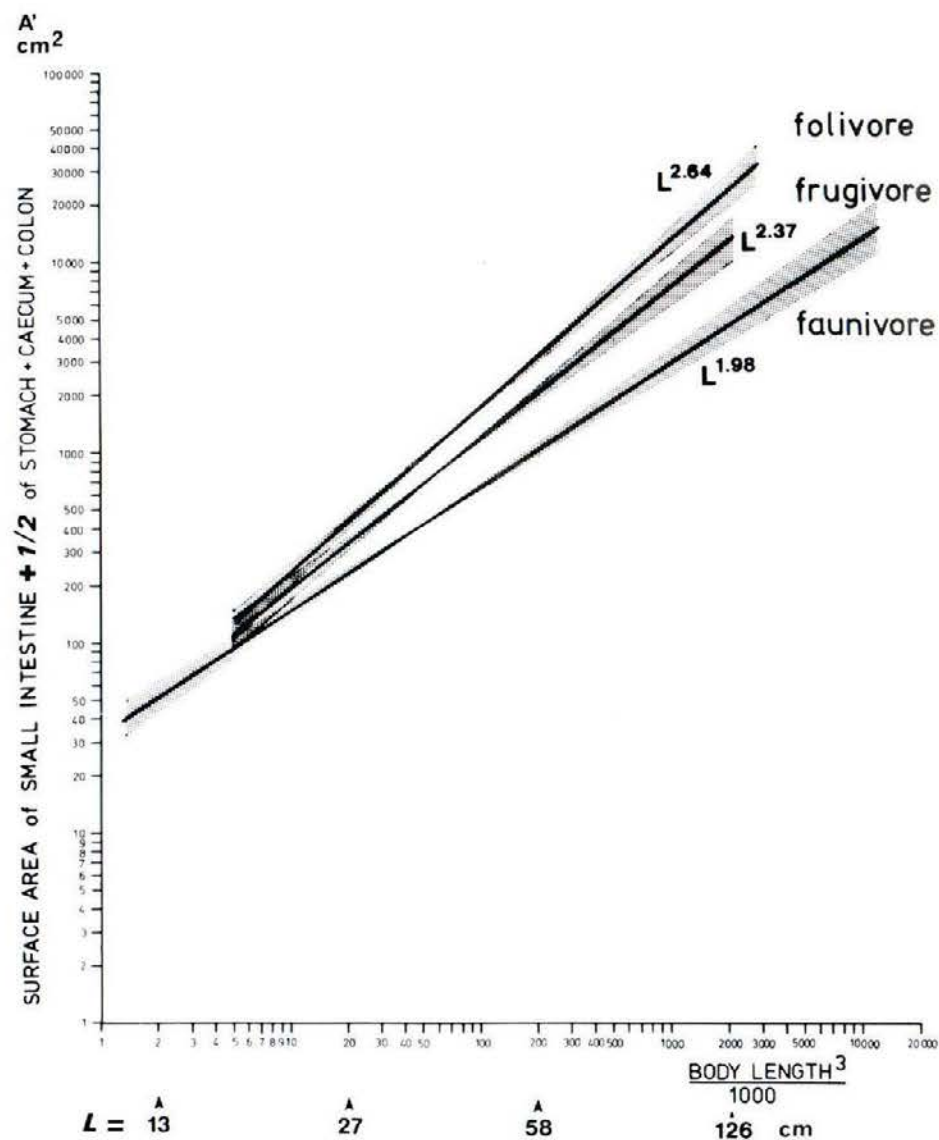

Fig. 26. The relationship between the potential area for absorption (surface area of small intestine and half the combined areas of stomach, caecum, and colon) and body size (from body length, cm) in faunivores, frugivores and folivores (two types combined), in the form of regressions derived from individual data. The correcting factors ( $L$ ), accounting for the allometric relations in each group, are markedly different, because of the variations in slope. The stippled areas demarcate the 95% confidence limits for the slopes; the three dietary groups are quite distinct at the 85% limit.

ed to different kinds of analysis, according to the relatively narrow question to which the researcher may be addressing him/herself (Hladik and Chivers, '78).

It need not matter if different methods of observation are used, so long as their reliability can be assessed to yield results that are truly comparable. In seeking correlations with gut morphology it is amounts of different foods ingested, rather than the time spent feeding on each, which are of paramount importance. It is relatively easy, in sampling the behavior of wild primates, to record accurately the details of feeding bouts in terms of time (Chivers, '74; Struhsaker, '78; MacKinnon and MacKinnon, '78), but it is much more difficult to measure the amounts ingested in terms of fresh (or dry) weight over a reasonable length of time (Hladik and Hladik '69, '72; Hladik, '73; Iwamoto, '74, '78; Raemackers, '77) and to analyze food composition (Hladik et al., '71; Hladik, '77a,b; Goodall, '77). Data based on the analysis of stomach contents pose special problems, but may yield the kind of measures required (Gautier-Hion, '78).

While the amounts of leaves and other vegetative plant parts ingested can be deduced with sufficient accuracy from feeding times, fruits may be underestimated as much as fivefold, and insects may be overestimated as much as 15 times, compared with the actual amount by weight (Hladik, '77a,b). While such distortions may fortuitously cancel each other out (Raemackers, '77), data based on time are obviously inappropriate for our purposes; mixing data based on time and weight should be treated with circumspection.

Different models have been proposed to represent the diets of wild primates, so as to account for the average intake of an individual and its variation over time (e.g., Hladik and Hladik, '69, '72; Suzuki, '65; Kay, '73; MacKinnon and MacKinnon, '78). The most effective method for representing a system containing three variables—animal matter, fruit, and leaves—is a tri-rectangular projection (or three-dimensional graph).

This approach involves plotting values for the three major categories of food in the diet within a three-dimensional system of converging axes (Fig. 27, right upper). Since the three variables are not independent (their sum is always 100%), the projection of any combined dietary value will fall within the triangle AFL, where point A represents a diet of 100% animal matter, point F a diet of 100% fruit, and point L a diet wholly of leaves. In this

triangle (Fig. 27), any point close to A represents a diet rich in animal matter, close to F rich in fruit, and close to L rich in leaves. Because of the construction of the triangle AFL, the dietary values (in terms of per cent of animals, fruit, and leaves) are plotted more conveniently along the perpendicular axes  $Ox$  and  $Oy$ . If  $OL = +100$  and  $OA = -100$ , then  $x = (\% \text{ leaves}) - (\% \text{ animals})$ , and  $y = \sqrt{3} (\% \text{ fruit})$ , for any point within the triangle.

In addition to pinpointing an average diet for each species (Fig. 27), the graph indicates its range of variation through the year. While these ranges may overlap, even among sympatric species, it may not be at the same time of year, but, more importantly, this similarity of gross categories obscures important differences in food choice (species and its different parts), and thus in biochemical composition. Nevertheless, this analysis is sufficient to identify and quantify significant differences between species, even those which have been regarded previously as similar, e.g., the "omnivorous," more properly frugivorous, primates such as *Cebus*, *Macaca*, and *Pan*. Although these three primates eat mostly fruit, the overlap represents but a small part of their dietary ranges; for the means ( $x = -5$ ,  $+15$ ,  $+26$  respectively), accounting for differences in the supplement of plant and animal matter, provide good diagnostic dietary indices.

To amplify the interspecific comparison, the mean diets of as many as possible of the mammalian species studied morphologically are plotted in Figure 28. This inevitably means adapting data based on time measures, but all values are derived from studies lasting more than 1 year (see, for example, Clutton-Brock, '77). The absence of plots near the baseline of the triangle is conspicuous, and is not a consequence of inadequate sampling of species. No mammal mixes large quantities of animal matter and leaves without including fruit in its diet. Since, as has been shown previously, faunivory and folivory represent contrasting, and incompatible, adaptations, the quantity of fruit in such a mixed diet should always be considerable. From the demonstration by Hladik et al. ('72) that fruit is an adequate source of carbohydrate for the energetic requirements of most primates but inadequate in protein, Kay ('73) argues that those primates securing this protein from insects are necessarily much smaller than those obtaining it from leaves.

Thus, as exemplified by primates, there are

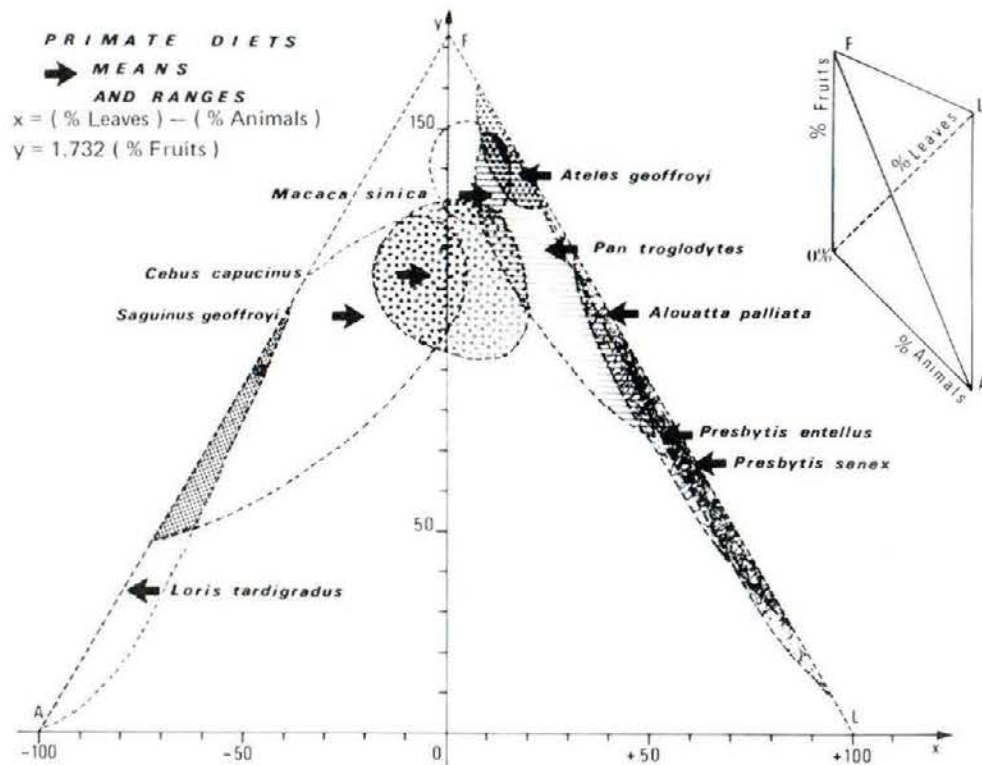

Fig. 27. Annual means and ranges of the diet of nine primate species from Panama, Gabon, and Sri Lanka (data from Hladik and Hladik, '69, '72; Hladik, '73) represented within a triangle (see text for explanation of its derivation from tri-rectangular projection, and its applications). The composition of the mean annual diet, in terms of proportions of animal matter, fruit, and leaves, is pinpointed by an arrow; most data, collected over 24-hour periods at all times of year, are included in the shaded area (only daily records which differ markedly from the previous or following days are excluded, because of the distortion they would introduce into the small sample).

optimum body sizes corresponding to the different feeding strategies:

	Body size kg (Kay, '73)	Biomass Kg/km <sup>2</sup> (Hladik, '78a)
Faunivores		
Frugivores	0.4	5
Folivores	4.0	300

We have arrived independently at conclusions similar to those of Kay ('73), who shows that primate species each specialize on either animal matter, fruit or leaves, although many specialize primarily on one category (> 45% dependence) and secondarily on another (>

20% dependence); for reasons given above, no species exceeds 20% for both animal matter and leaves.

Returning to Figure 27, it is not possible from the data available to predict a central minimum y-value, the lowest proportion of fruit taken by a frugivore. It is likely to be quite high, since the data are clearly distributed along a crescentic path from A to L via the vicinity of F, with the greatest range of y-values around the zero x-values. This represents, at least for primates, the evolutionary path from the ancestral insectivorous forms (Ripley, '79) through three ecological grades (Hladik, '78b).

The geometrical arrangement of the data, therefore, yield the x-values as the best indi-

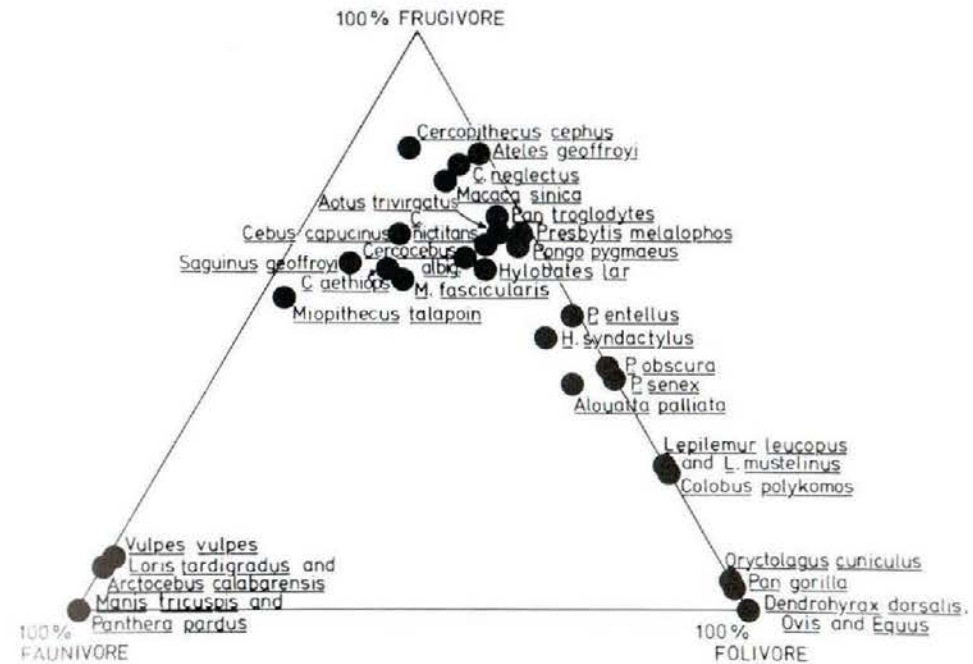

Fig. 28. Mean dietary characteristics of the 34 species included in this study (tables 5-8) for which quantitative data on diet are available. Locations within the triangle represent diets as shown in Figure 27.

cators of diet, varying from -100 (pure faunivores) to +100 (pure folivores). The final task is to relate these values to the dimensions of the gastro-intestinal tract.

Considering first the potential volumes for fermentation, the data for faunivores and folivores (excepting those with large stomachs) have been linearly regressed separately against body size (Fig. 22). These regressions are used to represent the structural limits for coping with the two extremes of diet (Fig. 29). Most primates fall within these limits, but the concentration of frugivorous species, represented by the third regression line, closer to the upper line, reflects their greater similarity to folivores than to faunivores. In order to derive a morphological index for comparison with the dietary one, we need a scale of negative and positive values to reflect their direction and degree of adaptation to either faunivory or folivory respectively. To account for the asymmetry in the relative positions of the regression lines, it is more appropriate to

take the line of the regression for frugivores as the zero, rather than a line midway between the regressions for folivores and faunivores.

Thus the morphological location of any species can be described as the distance D above or below this zero line, by the following conditional formula:

$$\text{if } V > V_f, D = + \frac{V - V_f}{V_f - V_f}$$

$$\text{if } V < V_f, D = - \frac{V_f - V}{V_f - V_a}$$

where V, V<sub>a</sub>, V<sub>f</sub> and V<sub>i</sub> represent the potential volumes for fermentation in the subject, and in faunivore, frugivore, and folivore of the same size, respectively; these latter are calculated from the regression equations relating to Figure 22, where body size is derived from the length L, the distance between bregma and ischial callosity. Since body weight W is



the more widely used measure of body size, the regression equations were recalculated according to the approximation,  $W = \frac{L^3}{30}$  (L in cm, W in gm<sup>3</sup>), which fits most of our specimens, yielding the same results:

$$\text{for faunivores,} \\ \log V = 0.95 (\pm 0.11) \log W - 1.07;$$

$$\text{for frugivores,} \\ \log V = 1.13 (\pm 0.12) \log W - 1.25;$$

$$\text{and for folivores,} \\ \log V = 1.20 (\pm 0.08) \log W - 1.18.$$

As shown in Figure 29, the asymmetry creates a discrepancy in the size of units above and below the zero line, since the extremes represented by the outer lines have values of -1 and +1. To attain a homogeneous distribution of the units, and thus the desired index of gut specialization, the distances D are transformed mathematically into the values TR<sub>(D)</sub>. The conditional formula used (Fig. 29)

is based on antilogarithms; although appearing very complex, on the small programmable calculator, now in wide use, it is almost as easy to use as the ordinary logarithm<sup>2</sup>.

This nonlinear transformation not only renders comparable scores above and below the zero line, but yields values that never exceed -100 or +100, however large the value of D (Fig. 29). The conditional formula is designed to produce values of -90 and +90 on the regression lines for animalivores and folivores, respectively. Because of the scatter around each regression line, it is unreasonable to assume that the upper one accounts for

<sup>1</sup> A regression of all data available in Tables 5-8 gives a relation,  $W = 0.041 \times L^{2.86}$  ( $r = 0.98$ ) or  $W = \frac{L^3}{24.4}$ . The approximation  $W = \frac{L^3}{30}$  is preferred, since it yields a better fit for most wild arboreal primates.

<sup>2</sup> On the HP 25 calculator the program is:  $g \times x \div 0 \text{ GTO } 07.1 \text{ CHS STO } 1 \times \approx y \text{ g ABS } 1 \text{ f } x < y \text{ GTO } 36 \times \approx y \text{ STO } 0 \times \approx y - 1 \times \approx y - g 10^x \text{ RCL } 3 \times \approx y - \text{RCL } 0 \times \text{RCL } 0 \times \text{RCL } 0 \times 10^x - 1 - \text{RCL } 2 \times \text{RCL } 0 \times 1 - x - \text{GTO } 44 - 1 \times \approx y - g 10^x \text{ RCL } 3 \times \approx y - \text{RCL } 1 \times 1 \text{ STO } 1 \times \approx y \text{ GTO } 00$ . After storing the values 1, 10, and 100 in registers 1, 2, and 3 respectively, any value of D introduced is transformed into TR<sub>(D)</sub> by pressing the RS key.

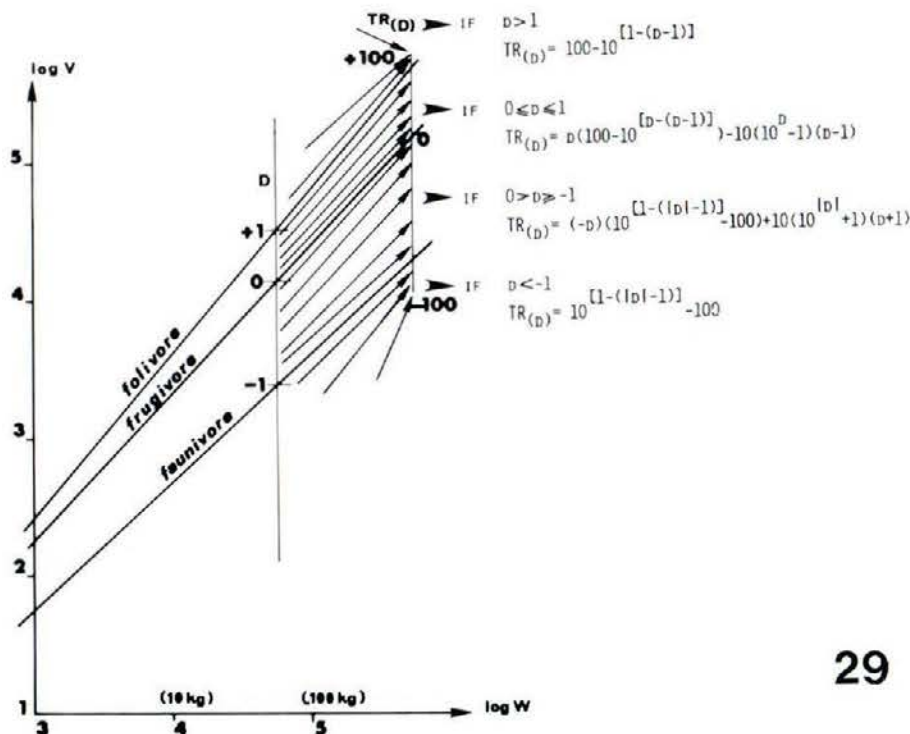

29

diets including more than 90% of leaves, and the lower one more than 90% of animal matter.

Such a method of nonlinear interpolation between two diverging regression lines, can be used as an approximation of the percentage "tendency" for any biological character varying between two opposite poles. In this case, we are indicating the extent to which each species is tending toward one dietary extreme or the other, having resolved the special allometric problems encountered. These indices of gut specialization, derived from potential fermenting volumes for all species except those with complex stomachs, are very similar to the dietary indices (see below).

The same method is applied to the potential absorbing area (including half the area of stomach and large intestine together with the area of small intestine) in all species. The regressions of these areas (A') are those of Figure 26. The asymmetry of the regression for frugivores in relation to the other two is even more marked; thus the conditional formula is used to locate each species, according to body size, at distance D above or below this zero line:

$$\text{if } A' > A'_f, D = + \frac{A' - A'_f}{A'_f - A'_a}$$

$$\text{if } A' < A'_f, D = - \frac{A' - A'_f}{A'_f - A'_a}$$

where A', A'<sub>a</sub>, A'<sub>f</sub>, and A'<sub>i</sub> represent the potential absorbing areas in the subject, and in faunivore, frugivore, and folivore of the same size, respectively. As in the preceding case, the regression equations were recalculated with references to body weight, rather than length:

	Gut specialization index		Dietary index (Fig. 27)
	by area, A'	by volume, V	x
<i>Miopithecus talapoin</i>	-85		-40 estimate, Fig. 28
<i>Ceropithecus cephus</i>	-27	-2	-10 estimate, Fig. 28
<i>Papio sphinx</i>	+9	0	
<i>Cebus capucinus</i>	+11		-5
<i>Macaca sinica</i>	+16	+22	+15
<i>Alouatta palliata</i>	+40	+31	+40
<i>Macaca sylvana</i>	+45	+85	
<i>Presbytis melalophos</i>	+82		folivore

Fig. 29. Method for comparing the potential volume of fermentation in the gastro-intestinal tracts of various primates with contrasting diets. The log of volume (of stomach, caecum, and colon) is plotted against the log of body weight (taking  $\frac{L^3}{30}$  as a good approximation for body weight), so as to eliminate allometric parameters. The resulting regressions from a large sample of faunivores and folivores (Fig. 22) are used again here, and considered as showing the structural limits for coping with diets containing 90% of animal matter and 90% of leaves, respectively. Most primates fall within these limits, and the distance D from the regression line for frugivores can be regarded as an indicator of the morphological tendency towards faunivory or folivory. The conditional formula presented allows a transformation of D into the index TR<sub>(D)</sub>, which, in most cases, is the same number as the dietary index, x, as defined from the tri-rectangular projection (Fig. 27).

$$\text{for faunivores,} \\ \log A' = 0.66 (\pm 0.06) \log W - 0.49;$$

$$\text{for frugivores,} \\ \log A' = 0.79 (\pm 0.09) \log W - 0.33;$$

$$\text{and for folivores,} \\ \log A' = 0.86 (\pm 0.15) \log W - 0.15.$$

The asymmetry again creates a discrepancy in the size of units above and below the zero line, so the transformation TR<sub>(D)</sub> is performed, as shown in Figure 29. This yields indices of gut specialization, in terms of area, which are also very similar to the dietary indices.

In these operations we are locating each species in relation to all others, according to the gross dietary classification derived previously. Thus, it is not surprising, with the large samples, that there is good correspondence between morphological and dietary indices. The problem of scatter is not easy to resolve, because of the difficulties in measuring such a malleable morphological system, and of individual variation within species.

The major advance resulting from this approach is that, having resolved the complex allometric problems, mammalian species following different adaptive strategies may be compared quantitatively. It is possible to delimit the "ecophysiological tendency" for each species, especially for primates, whose body sizes fall in the central part of the range investigated. For example, among the so-called "omnivorous" primates, which feed on variable amounts of fruit, insects, and leaves, the significant differences in diet which have been demonstrated recently follow those between the various indices:

The similarities between indices for each species are pleasing, considering that morphological indices refer to single individuals, and the dietary indices are derived separately from data of variable quality. The success of this approach depends on a) obtaining adequate gut samples that are truly representative of the population from which dietary data are obtained, b) obtaining adequate dietary data, in terms of weight of each food ingested, and c) defining in which species morphological adaptations may confer greater dietary flexibility, e.g., variations across the geographical range and feeding behavior in captivity.

Reference has been made to the convergence of the regression lines for potential absorbing area, A' (Fig. 26), which renders this model inapplicable to species smaller than 27 cm body length. In such cases the model based on potential fermenting volumes, V (Figs. 22, 29) is quite satisfactory for small species. Figures for folivores with large stomachs, however, are not included in Figure 29. To derive indices of gut specialization (GSI) for such forms, either the A' model should be used, or the V model revised using the regression line for folivores with large stomachs (Fig. 22).

The specialized seed-eaters have not been included in these models; if primates eat seeds they usually do so in small quantities and when they are unripe. Certain frugivorous squirrels of Gabon also consume some insects (Emmons, '75) and *Epixerus ebii*, for example (see Table 8), has a GSI from V of -16. Gut specialization indices of other rain-forest squirrels have been calculated from data collected recently in Malaysia (Payne, '79). The small *Sundasciurus tenuis*, of length 13 cm, which eats mostly bark, sap, and seeds, and some insects, has an index of +100. The fruit-eating species *Callosciurus notatus* and *C. prevosti* have indices of +97 and -22 respectively, with the latter eating considerably more soft fruit; in contrast, the seed-eating *Ratufa bicolor* has an index as low as -93. Seeds rich in protein and fat seem to need processing more like animal matter than the vegetative parts of plants. An unusual primate, *Cercopithecus neglectus*, whose diet is known to include large quantities of seeds (Gautier-Hion, '78), also has low indices. Thus further research is needed on the composition, consumption, and assimilation of seeds ingested by mammals.

In the search for a full physiological explanation of the relationships between morphology and diet, that we have quantified, two

main lines of research should be followed. There needs to be more extensive analysis and quantification of the biochemical composition of foods, in relation to diet, and of the fine structure and cellular populations of the gastro-intestinal mucosa, in relation to morphology. At the same time, the quantity and comparability of the kinds of morphological and dietary data discussed herein must be improved, if we are to understand the real significance of "sacs" and "tubes."

#### ACKNOWLEDGMENTS

We thank the Smithsonian Institution, especially Dr. Martin Moynihan, who obtained funding for C.M.H. at the Smithsonian Tropical Research Institute from 1966 to 1968. C.M.H. was also funded in 1969-1970 by the Smithsonian Biological Program in Ceylon, administered by Drs. John Eisenberg and Suzanne Ripley. Since then he has been employed at the Museum of Natural History, Brunoy, by the Centre National de la Recherche Scientifique (France). Since 1970 D.J.C. has been employed by the University of Cambridge; he acknowledges the facilities generously provided for his studies, and grants from the Department of Anatomy and University Travelling Expenses Fund for 2-month visits to Malaysia in 1972, 1974, and 1976, where local travel was aided by a Royal Society Government Grant-in-Aid.

C.M.H. acknowledges gratefully the cooperation of the Panamanian authorities, the Wildlife Department of Sri Lanka, the Gabonese authorities involved in the C.N.R.S. Station of Ipassa/Makokou, the Forest Department of Morocco, and the Service des Eaux et Forêts de Madagascar; and D.J.C. the Head Office of the Game Department (now the Department of Wildlife and National Parks), the State Game Wardens of Pahang and Perak and their staff, and the Institute for Medical Research in Kuala Lumpur, Malaysia. In France guts of primates were obtained from the Museum d'Histoire Naturelle in Paris, and in England from Miss Mary Brancker, veterinary surgeon to Twycross Zoo, and from the Zoological Society of London. We are grateful to Professor R.J. Harrison for the opportunity to include marine mammals in our survey, and to Mr. David Ellis for providing a variety of British mammals.

We are also indebted to those who assisted us in our unsavory labors, especially our wives, Sarah Chivers and Annette Hladik, and to the Visual Aids Unit, Department of

Anatomy, Cambridge, for their reproduction of the figures. Finally, we thank Donald Steven and R.D. Martin in particular among those who have given helpful advice during the course of this work; and Donald Steven, John Payne, Pierre Charles-Dominique, G. Cansela da Fonseca, and Gerard Dubost for their constructive comments on the manuscript.

#### LITERATURE CITED

- Bolk, L., E. Göppert, E. Kallius, and W. Lubosch (1939) Handbuch der vergleichenden Anatomie der Wirbeltiere. Band III. Darmsystem. Urban and Schwarzenberg, Berlin and Vienna.
- Bell, G.H., J.N. Davidson, and H. Scarborough (1963) Textbook of Physiology and Biochemistry. Fifth edition. Livingstone, Edinburgh.
- Carleton, M.D. (1973) A survey of gross stomach morphology. In: New World Cricetinae (Rodentia, Muroidea), with comments on functional interpretations. Misc. Publ. Mus. Zool., University of Michigan, No. 146, pp. 1-43.
- Charles-Dominique, P., and C.M. Hladik (1971) Le lémur du sud de Madagascar. Terre et Vie, 25:3-66.
- Charles-Dominique, P. (1978) Ecologie et vie sociale de *Nandinia binotata* (Carnivores, Viverridés): Comparaison avec les prosimiens sympatriques du Gabon. Terre et Vie, 32:477-528.
- Chivers, D.J. (1974) The Siamang in Malaya. Primatol. 4:1-335.
- Chivers, D.J., and J. Herbert (1978) Recent Advances in Primatology. Vol. 1. Behaviour. Academic Press, London.
- Clutton-Brock, T.H. (1977) Primate Ecology. Studies of Feeding and Ranging Behaviour in Lemurs, Monkeys and Apes. Academic Press, London.
- Comline, R.S., I.A. Silver, and D.H. Steven (1968) Physiological anatomy of the ruminant stomach. In: Handbook of Physiology. Sect. 6 (alimentary canal). Vol. 5. Am. Physiol. Soc., Washington, pp. 2647-2671.
- Crowcroft, P. (1952) Reflection in the common shrew. Nature, 170:627.
- Cuvier, G. (1805) Leçons d'Anatomie Comparée. Crochard, Paris.
- Ellenberger, W., and H. Baum (1921) Handbuch der vergleichenden Anatomie der Haustiere. Hirschwald, Berlin.
- Emmons, L. (1975) Behaviour and Ecology of African Rain Forest Squirrels. Ph.D. dissertation, Cornell University, Ithaca, New York.
- Fooden, J. (1964) Stomach contents and gastro-intestinal proportions in wild shot Guianan monkeys. Am. J. Phys. Anthropol., n.s., 22:227-231.
- Gautier-Hion, A. (1978) Food niches and coexistence in sympatric primates in Gabon. In: Recent Advances in Primatology. Vol. 1. Behaviour. D.J. Chivers and J. Herbert, eds. Academic Press, London, pp. 269-286.
- Genest-Villard, H. (1968) L'estomac de *Lophuromys sikapusi* (Rongeurs, Muridés). Mammalia, 32:639-656.
- Giesscke, D. (1969) Comparative microbiology of the alimentary tract. In: Physiology of Digestion and Metabolism in the Ruminant. A.T. Phillipson, ed. Oriel Press, Newcastle, pp. 306-318.
- Goodall, A.G. (1977) Feeding and ranging behaviour of a mountain gorilla group in the Tshibinda-Kahuzi region (Zaire). In: Primate Ecology: Studies of Feeding and Ranging Behaviour in Lemurs, Monkeys and Apes. T.H. Clutton-Brock, ed. Academic Press, London, pp. 449-479.
- Grassé, P.P. (1955) Traité de zoologie: Anatomie, systématique, biologie. Mammifères, fasc. 2:1646-1653. Masson, Paris.
- Harrison, R.J., F.R. Johnson, and B.A. Young (1970) The oesophagus and stomach of dolphins. *Tursiops, Delphinus, Stenella*. J. Zool., London, 160:377-390.
- Hill, W.C.O. (1958) Pharynx, oesophagus, stomach, small and large intestine: Form and position. Primatologia, 3:139-207.
- Hladik, C.M. (1967) Surface relative du tractus digestif de quelques primates, morphologie des villosités intestinales et corrélations avec le régime alimentaire. Mammalia, 31:120-147.
- Hladik, C.M. (1973) Alimentation et activité d'un groupe de chimpanzés réintroduit en forêt gabonaise. Terre et Vie, 27:343-413.
- Hladik, C.M. (1975) Ecology, diet and social patterning in Old and New World primates. In: Socio-ecology and Psychology of Primates. R.H. Tuttle, ed. Mouton, The Hague, pp. 3-36.
- Hladik, C.M. (1977a) Chimpanzees of Gabon and chimpanzees of Gombe. In: Primate Ecology. Studies of Feeding and Ranging Behaviour of Lemurs, Monkeys and Apes. T.H. Clutton-Brock, ed. Academic Press, London, pp. 595-601.
- Hladik, C.M. (1977b) A comparative study of feeding strategies of two sympatric species of leaf monkeys: *Presbytis senex* and *Presbytis entellus*. In: Feeding and Ranging Behaviour of Lemurs, Monkeys and Apes. T.H. Clutton-Brock, ed. Academic Press, London, pp. 481-501.
- Hladik, C.M. (1978a) Adaptive strategies of primates in relation to leaf-eating. In: Ecology of Arboreal Folivores. G.G. Montgomery ed. Smithsonian Institution Press, Washington, pp. 373-395.
- Hladik, C.M. (1978b) Diet and ecology of prosimians. In: The Study of Prosimian Behaviour. G.A. Doyle and R.D. Martin, eds. Academic Press, New York, pp. 307-357.
- Hladik, C.M., and P. Charles-Dominique (1974) The behaviour and ecology of the sportive lemur (*Lepilemur mustelinus*) in relation to its dietary peculiarities. In: Prosimian Biology. R.D. Martin, G.A. Doyle, and A.C. Walker, eds. Duckworth, London, pp. 23-37.
- Hladik, C.M., and D.J. Chivers (1978) Concluding discussion: Ecological factors and specific behavioural patterns determining primate diet. In: Recent Advances in Primatology. Vol. 1, D.J. Chivers and J. Herbert, eds. Academic Press, London, pp. 433-444.
- Hladik, A., and C.M. Hladik (1969) Rapports trophiques entre végétation et primates dans la forêt de Barro Colorado (Panama). Terre et Vie, 26:25-117.
- Hladik, C.M., and A. Hladik (1972) Disponibilité alimentaires et domaines vitaux des primates à Ceylan. Terre et Vie, 26:149-215.
- Hladik, C.M., A. Hladik, J. Bousset, P. Valdebouze, G. Viroben, and J. Delort-Laval (1971) Le régime alimentaire des primates de l'île de Barro Colorado (Panama): Résultats des analyses quantitatives. Folia Primatol., 16:85-122.
- Iwamoto, T. (1974) A bioeconomic study on a provisioned troop of Japanese monkeys (*Macaca fuscata*) at Koshima Islet, Miyazaki. Primates, 15:241-262.
- Iwamoto, T. (1978) Food availability as a limiting factor on population density of the Japanese macaque and gelada baboon. In: Recent Advances in Primatology. Vol. 1. D.J. Chivers and J. Herbert, eds. Academic Press, London, pp. 286-303.
- Janis, C. (1976) The evolutionary strategy of the Equidae and the origins of rumen and caecal digestion. Evolution, 30:757-774.
- Kay, R.F. (1973) Mastication, Molar Tooth Structure and Diet in Primates. Ph.D. dissertation, Yale University, New Haven.
- Kay, R.N.B., and E. Pfeffer (1969) Movements of water and electrolytes into and from the intestine of the sheep. In:

- Physiology of Digestion and Metabolism in the Ruminant. A.T. Phillipson, ed. Oriel Press, Newcastle, pp. 390-402.
- Kaysner, C. (1963) Digestion et absorption. In: *Physiologie*. Vol. 1. C. Kayser, ed. Flammarion, Paris, pp. 247-406.
- Kuhn, H.J. (1964) Zur Kenntnis von Bau und Funktion des Magens der Schlangaffen (Colobidae). *Folia Primatol.*, 2: 193-221.
- MacKinnon, J.R., and K.S. MacKinnon (1978) Comparative feeding ecology of six sympatric primates in West Malaysia. In: *Recent Advances in Primatology*. Vol. 1. D.J. Chivers and J. Herbert, eds. Academic Press, London, pp. 305-321.
- Magnan, A. (1912) Le régime alimentaire et la longueur de l'intestin chez les Mammifères. *C.R. Acad. Sci. (Paris)*, 154:129-131.
- McMahon, T. (1973) Size and shape in biology. *Science*, 179:1201-1204.
- Mitchell, P.C. (1905) On the intestinal tract of mammals. *Trans. Zool. Soc. London*, 17:437-536.
- Moir, R.J. (1968) Ruminant digestion and evolution. In: *Handbook of Physiology*. Sect. 6. Alimentary Canal. Vol. 5. Am. Physiol. Soc., Washington, pp. 2673-2694.
- Moore, P.G., D.E. Edward, and G.A. Shirley (1972) *Standard Statistical Methods*. Pitman, London.
- Morot, C. (1882) Mémoire relatif aux pelotes stomacales des léporidés. *Rec. Med. Vet.*, 59:635-646.
- Parra, R. (1978) Comparison of fore-gut and hind-gut fermentation in herbivores. In: *The Ecology of Arboreal Folivores*. G.G. Montgomery, ed. Smithsonian Institution Press, Washington, pp. 205-229.
- Payne, J.B. (1979) On the Ecology of Malayan Rain-Forest Squirrels. Ph.D. dissertation. University of Cambridge, Cambridge.
- Raemaekers, J.J. (1977) Gibbons and Trees: Comparative Ecology of Siamang and lar Gibbons. Ph.D. dissertation. University of Cambridge, Cambridge.
- Ripley, S. (1979) Environmental grain, niche diversification and positional behaviour in Neogene primates. In: *Environment, Behaviour and Morphology: Dynamic Interactions in Primates*. H. Preuschoft and M.E. Morbeck, eds. Gustav Fischer, New York, pp. 37-74.
- Schmidt-Nielsen, K. (1972) *How Animals Work*. Cambridge University Press, Cambridge.
- Sineshcheckov, A.D. (1965) Digestion and assimilation processes in the stomach and intestines of ruminant. In: *Physiology of Digestion in the Ruminant*. R.W. Dougherty, ed. Butterworths, London, pp. 254-261.
- Struhsaker, T.T. (1978) Food habits of five monkey species in the Kibale Forest, Uganda. In: *Recent Advances in Primatology*. Vol. 1. D.J. Chivers and J. Herbert, eds. Academic Press, London, pp. 225-248.
- Suzuki, A. (1965) An ecological study of wild Japanese monkeys in snowy areas, focused on their food habits. *Primates*, 7:481-487.
- Taylor, E.L. (1940) The demonstration of a peculiar kind of coprophagy normally practised by the rabbit. *Vet. Record*, 52:259-262.
- Tucker, V.A. (1970) Energetic cost of locomotion in animals. *Comp. Biochem. Physiol.*, 34:841-846.
- Vallenas, A., J.F. Cummings, and J.F. Munnell (1971) A gross study of the compartmentalised stomach of two New World camelids, the llama and guanaco. *J. Morphol.*, 134:399-424.

Adresse de C.M. Hladik en 2013 :

Claude Marcel HLADIK  
 Directeur de recherche émérite  
 Eco-Anthropologie et Ethnobiologie  
 Muséum National d'Histoire Naturelle  
 4 avenue du Petit Château  
 91800 Brunoy (France)

cmhladik@mnhn.fr

<[http://www.ecoanthropologie.cnrs.fr/IMG/pdf\\_Site-WEB-Hladik-2013.pdf](http://www.ecoanthropologie.cnrs.fr/IMG/pdf_Site-WEB-Hladik-2013.pdf)>

