



HAL
open science

Comparison of Damato campimetry and Humphrey automated perimetry results in a clinical population

Fiona J Rowe, Henri M Sueke, Sandra D Gawley

► **To cite this version:**

Fiona J Rowe, Henri M Sueke, Sandra D Gawley. Comparison of Damato campimetry and Humphrey automated perimetry results in a clinical population. *British Journal of Ophthalmology*, 2010, 94 (6), pp.757. 10.1136/bjo.2009.161240 . hal-00557324

HAL Id: hal-00557324

<https://hal.science/hal-00557324>

Submitted on 19 Jan 2011

HAL is a multi-disciplinary open access archive for the deposit and dissemination of scientific research documents, whether they are published or not. The documents may come from teaching and research institutions in France or abroad, or from public or private research centers.

L'archive ouverte pluridisciplinaire **HAL**, est destinée au dépôt et à la diffusion de documents scientifiques de niveau recherche, publiés ou non, émanant des établissements d'enseignement et de recherche français ou étrangers, des laboratoires publics ou privés.

**Comparison of Damato campimetry and Humphrey automated perimetry results in a clinical
population**

Fiona J Rowe¹, Henri Sueke², Sandra D Gawley²

1 Directorate of Orthoptics and Vision Science, University of Liverpool, Liverpool, UK

2 Department of Ophthalmology, Warrington and Halton Hospitals NHS Foundation Trust,
Warrington, UK

Address for contact:

Dr Fiona Rowe

Directorate of Orthoptics and Vision Science

Thompson Yates Building

University of Liverpool

Brownlow Hill

Liverpool L69 3GB

T: 0151 7945732

F: 0151 7945781

E: rowef@liverpool.ac.uk

Disclaimers: None

Licence for Publication: The Corresponding Author has the right to grant on behalf of all authors and does grant on behalf of all authors, an exclusive licence (or non exclusive for government employees) on a worldwide basis to the BMJ Publishing Group Ltd to permit this article (if accepted) to be published in BJO and any other BMJPGJ products and sublicences such use and exploit all subsidiary rights, as set out in our licence (<http://bjournal.bmj.com/fora/licence.pdf>).

Competing interests: The Damato campimeter used in this study was provided by Professor Bertil

Damato, St Pauls Eye Unit, Royal Liverpool and Broadgreen University Hospitals, Liverpool, UK.

Running head: Damato versus Humphrey visual field assessments

Word count: 2634

Figure and table count: 5

ABSTRACT

Background/aims: The purpose was to evaluate patient's ease of understanding of Damato campimetry assessment and determine sensitivity and specificity of results compared to Humphrey automated perimetry.

Methods: Patients underwent Humphrey perimetry and Damato campimetry on the same day.

Patients were excluded if unable to undergo Humphrey perimetry. Results were graded as matched, partially matched and not matched with those of Humphrey perimetry.

Results: 100 patients (197 eyes) were assessed: 62 females and 38 males with mean age of 62.8 Years (SD 15.98). It was not possible to plot Damato campimetry in 19 eyes (6.5%); 13 due to lack of understanding and 6 due to low vision. 178 eyes were tested with both methods. Results showed 94 eyes as true positives, 45 true negatives, 22 false negatives and 17 false positives. 95 eyes had

matched visual field results, 5 partial matches and 78 eyes (36%) not matched. The extent of agreement was 0.216 (0.073/0.36CI) with Kappa analysis.

Conclusions: We found Damato campimetry to be a useful portable device to assess the visual field with optimal sensitivity of 81% and specificity of 72% based on comparison to a Humphrey 24-2 programme. 6.5% were unable to do the test. 64% had matched or partially matched results from both assessments. Further study is required to compare complete results to a Humphrey 30-2 programme and, additionally, in populations where patients do not have access to out-patient formal visual field assessments.

Keywords: Damato campimetry, Humphrey field analyser, Oculokinetic perimetry, Sensitivity, Specificity

INTRODUCTION

In the hospital eye service, quantitative perimetry typically involves the use of specialist equipment¹. These perimeters are not readily portable outside the ophthalmic unit.

Qualitative assessment of the visual field most commonly involves the technique of confrontation where an evaluation is made of the peripheral boundaries of the field of vision, in each quadrant of the field of vision and for colour sensitivity. However qualitative assessment by confrontation is subject to considerable bias effects and hence can be inaccurate².

Damato campimetry is available as a screening assessment which provides a quantitative measure of the visual field. This is easily portable and assesses the central 30 degrees of the visual field. It has been evaluated against automated perimetry in subjects with normal visual fields and patients with

glaucoma³⁻⁸. One study has compared it to confrontation in acute stage stroke patients⁹. For patients attending out patient hospital eye services, assessment of visual field will usually involve static or kinetic perimetry. Humphrey, Goldmann and Octopus perimetry methods are considered gold standard for quantitative perimetry. Where such perimeter are unavailable for use, alternative methods must be considered such as confrontation. However, reliability of confrontation is questionable, particularly for field loss that is not absolute or involving a considerable proportion of visual field.

We wished to consider the alternative uses of the Damato campimeter in the hospital eye service. As our gold standard is static and kinetic perimetry, we chose to compare the campimeter to Humphrey standard automated perimetry. Referrals to our visual field clinics consist mainly of glaucoma and ocular hypertension patients and suspects, but also neuro ophthalmology and optic neuropathy cases, etc. Thus we wished to evaluate the accuracy of Damato campimetry assessment across this wide range of ocular conditions requiring visual field evaluation.

The primary objectives were to determine the ease of understanding of the test by patients and determine the sensitivity and specificity of the test in comparison to Humphrey visual field assessment. By evaluating the sensitivity and specificity of the Damato test we wished to determine its reliability and validity for use in eye services.

MATERIALS AND METHODS

The Damato 60-point campimeter (Precision Vision™, USA) was used in this study (figure 1). It is a hand held device which can be propped on a table to ease its handling by the patient. This examines the central 30 degrees of the field of vision and consists of 60 numbered points: the numbers are printed in blue colour. It includes a single dial with five contrast levels. For the purposes of this study, we chose the 3mm 100% contrast black target instead of a lower contrast target as we wished

to use the test as a screening tool. The test has a hinged arm of 40cms length with an occluder on the end of the arm. The patient was instructed to look from number to number in a consecutive sequential manner and to report if the central black target disappeared from view while looking at each number. If the target disappeared the corresponding number at which this happened was marked on the recording chart. Results were recorded by the examiner without comment so as not to create any bias. The test was performed in ambient light conditions in the same room for all patients. Patients wore their appropriate near spectacle correction if required. The examiner was seated directly opposite the patient in order to observe patient fixation at all times.

Humphrey automated perimetry was undertaken in all patients using the central 24-2 programme. Reliability was determined for Humphrey perimetry results by documenting fixation losses, false positive and false negative catch trials. Presence of visual field defect was defined as presence of 2 or more affected adjacent points at $p=0.01$ ^{10,11}.

The 24-2 programme is the standard test choice in our visual field clinics. Participants did not undergo a 30-2 programme as this would have required a further change to their standard clinical assessment which was not specified in the ethical approval for this study. Therefore, for analysis the peripheral 30 degree points on the Damato chart were excluded from analysis as there were no corresponding points on the 24-2 result to compare these to. Three clinicians (a clinician undertaking the routine clinical visual field analysis plus HS and SG) performed the visual field assessments and were masked to the results of each test and were not involved in the data analysis.

The study design was a prospective, cross section study. Participants were identified randomly, i.e. notes were taken consecutively from the list waiting for visual field assessment without prior knowledge of the reason for requiring visual field assessment or knowledge of patient ability and cognition. A selection bias existed in that the patients recruited to this study had been booked in to an out-patient visual field clinic. Thus, there was an assumption that these patients had sufficient

ability and cognition to undertake standard automated perimetry, although occasionally this was not the case. Although we did not know the patient's ocular condition or status of visual field prior to recruitment, there was an inherent knowledge that they should be able to perform the visual field task.

The target population was patients referred for assessment of visual field regardless of their ocular diagnosis. Glaucoma suspects were defined as patients with evidence of raised intra ocular pressure but with no prior evidence of optic disc or visual field defect. Screened subjects were defined as those with family history of glaucoma and neuro ophthalmology referrals, but with no known visual field impairment.

The study protocol consisted of visual field assessment with both Humphrey automated perimetry and Damato campimetry on the same day. The order of testing was randomised as to which of the two assessment types was used first and also for which eye was tested first in order to take fatigue effect in to consideration. We did not specify inclusion criteria. The only exclusion criterion was for patients who were unable to undertake Humphrey automated perimetry. If deemed to be able to complete Humphrey automated perimetry, patients were also deemed capable of undertaking the Damato campimetry assessment. Reasons for being unable to undertake Humphrey perimetry included poor cognition, being unwell and mobility issues such as being unable to sit upright at the Humphrey for the required duration of the test. All patients underwent perimetry following full explanation of the purpose of the test and procedure. The demonstration option on the Humphrey perimeter was not used.

Full ethical approval for this study was granted by Cheshire East Research Ethics Committee in addition to institutional R&D approval. Informed, written consent was obtained from all participants and the study complied with the Tenets of Helsinki. Patients were informed that the only additional

task required of them was completion of the Damato visual field assessment. No patient declined to participate in the study.

Statistical evaluation included calculation of sensitivity and specificity plus positive/negative predictive values.

Comparisons of visual field results were made in three groups:

1. Match – Normal results for both OR Visual field defect on both that were the same for location
2. Partial match – Visual field defect on both that were similar but overlapping in different locations
3. Non match – Normal result on one test but not the other OR visual field defect on both but in completely different locations.

Kappa statistical evaluation was used to assess the extent of agreement that may have occurred beyond chance.

RESULTS

100 patients (197 eyes) were recruited to this study in 2007-2008 at Warrington and Halton Hospitals NHS Foundation Trust: 62 females and 38 males with a mean age of 62.8 Years (SD 15.98 years, range 24 to 90). 100 right eyes and 97 left eyes were assessed. Mean visual acuity was 0.10 logMAR (SD 0.26, range -0.2 to 1.75). Multiple diagnoses were recorded (figure 2). There were no adverse effects from performing Humphrey perimetry or Damato campimetry.

Of 197 eyes (figure 3) it was not possible to plot a Damato result in 19 eyes (9.5%). Ocular diagnoses for these patients included screening, primary open angle glaucoma and tilted discs. In 13 eyes

(6.5%) the patient could not understand how to do the test as they could not grasp the concept of looking at the numbers and not at the central target. In six eyes (3%) there was poor visual acuity which prevented the patient from seeing the blue numbers on the screen. The visual acuity for these eyes was a mean of 0.86 logMAR (one eye with 0.6, two eyes with 0.9 and three eyes with 1.0). 178 eyes underwent assessment by both Humphrey perimetry and Damato campimetry (table 1).

Table 1 Sensitivity and specificity calculation

		Humphrey perimetry		
		Positives	Negatives	
Damato campimetry	Positives	True positive 94 eyes	False positive 17 eyes	Positive predictive value 0.85
	Negatives	False negative 22 eyes	True negative 45 eyes	Negative predictive value 0.67
		Sensitivity 0.81	Specificity 0.72	

94 eyes (53%) had visual field defects detected by both assessments (true positives). 45 eyes (25.5%) had normal results on both assessments (true negatives). 22 eyes (12%) had a normal result on Damato assessment but with a visual field defect on Humphrey assessment (false negative). 17 eyes (9.5%) had a normal result on Humphrey assessment but with visual field defect on Damato assessment (false positive). The sensitivity and specificity for Damato campimetry in comparison to Humphrey perimetry was 81% and 72% respectively with a positive predictive value of 75% and negative predictive value of 67%. The assessments of 178 eyes were compared. 109 eyes (61.2%) were classed as a match, 5 eyes (2.8%) as a partial match and 64 eyes (36%) were classed as a non match (figure 4). Extent of agreement by Kappa analysis was 0.216 (0.073/0.36CI) which indicated only slight agreement.

Thirty-four of 197 eyes (17%) from 22 patients had low reliability based on combined fixation losses, false positive and false negative responses greater than 20%. Eighteen eyes (53%) were classed as a match, 4 eyes (12%) as a partial match and 12 eyes (35%) were classed as a non-match.

Test duration was not assessed for all patients undergoing Damato assessment. A pilot of 10 assessments (20 eyes) showed test durations of 1.45 minutes to 4.00 minutes per eye with comparative Humphrey test durations of 4.30 minutes to 9.00 minutes per eye.

On Humphrey perimetry, patients with normal visual field results had a mean mean-deviation (MD) of -0.96 (SD 1.32), mean pattern standard deviation (PSD) of 1.54 (SD 0.43) and mean duration of 4.39 minutes (SDE 1.13). Patients with visual field defects had a mean MD of -6.33 (SD 6.24), mean PSD of 5.14 (SD 3.80) and mean duration of 5.37 minutes (SD 1.75).

DISCUSSION

Damato campimetry involves movement of the eyes instead of the test stimulus and has been termed oculokinetic perimetry^{3,4}. It has been proposed as a method of home assessment and a method to enable health care professionals to participate in screening programmes³.

Our aims were to determine the ease of understanding by patients and determine the sensitivity and specificity of results in comparison to Humphrey perimetry. We firstly questioned whether there were any difficulties in patient understanding of the test which would lead to an inability to undertake the test. It was not possible to undertake Damato assessment in 13 eyes (6.5%)[7 patients] because of a failure to understand the procedure. Damato³ stated that the majority of subjects invited to carry out the assessment understood what was required of them.

Failure to understand the test could increase in populations such as stroke survivors due to the frequent association of cognitive defects following cerebrovascular accident. Cassidy et al⁹ found that of 75 stroke patients with visual field impairment indicated by clinical examination only 19 were able to cooperate with oculokinetic perimetry. Reasons included impaired language function, confusion and ability to concentrate. It is unclear from this study if the oculokinetic perimetry method consisted of the Damato campimeter. Further research of this particular population is required to answer what extent such cognitive defects impact on the ability to understand and thus undertake Damato campimetry. However, all patients in this study with neurological conditions such as head injury, multiple sclerosis, stroke and pituitary adenoma were able to perform the test. A distinction may perhaps be required between acute stage and assessment at a later time interval.

In this study, for six eyes (3%) the assessment could not be undertaken because of low vision whereby the patient could not see the blue numbers on the test screen. These patients were able to fixate the central bright orange light on the Humphrey perimeter. To our knowledge this has not been reported previously and is a factor that will have to be considered as a limitation on the use of

this assessment. Thus knowledge of visual acuity is essential before considering whether patients can undertake this assessment.

In comparison to Tubinger perimetry (automated static stimuli), 9% of subjects produced false negatives and 13% produced false positives with Damato campimetry³. 33% were reported as having normal visual fields but with some missed peripheral test locations on Damato campimetry³. We noted false negatives of 12% and false positives of 9.5%.

Yamada et al⁵ compared Damato campimetry and frequency doubling technology to Humphrey perimetry using subjects with normal visual fields and patients with definite glaucoma. Optimal sensitivity and specificity values were reported as 53% and 90% respectively. This compared to sensitivity and specificity values of 61% and 83%, 85% and 62%, 80% and 88% respectively among clinic based populations⁶⁻⁸ in which Damato campimetry was also compared to Humphrey perimetry. Our sensitivity and specificity values were 81% and 72% respectively in our clinic based population. Variances across all studies are likely to relate to the different models of Damato campimetry used, number of test locations and presented stimuli, and differences in populations studied. These factors should be taken into consideration and the appropriate Damato model chosen according to the required number of test locations for the population that the assessment is to be used with.

One limitation of our study is that we used 24-2 programme on Humphrey perimetry and not the 30-2 programme. The reason for this was the 24-2 is our test choice for central visual field assessment. In order to minimise the impact of this research study to already busy out-patient clinics, we decided not to alter the test choice but to discount the peripheral 30 degree points on the Damato test. The purpose was to determine accuracy of the test and this could be achieved by comparing the points of the 24-2 programme against the corresponding points on the Damato chart. Never-the-less, it is acknowledged that sensitivity and specificity may alter if the peripheral 30 degree points that we

discounted could have been compared to visual field results from a 30-2 Humphrey perimetry programme.

A number of studies have reported whether defects found by Damato campimetry match defects found on alternative perimetry. A good match was found in 76% of patients comparing Damato campimetry to Tubinger perimetry³. A further study categorised results as matched, partly matched and no match for abnormal areas⁵. When matched and partly matched grades were combined the Damato and Humphrey results had an 89% agreement level. When combining the matched and partly matched grades from our study, the agreement between results was 64% which is lower than previously reported and also reflects the negative predictive value of 58%. The low percentage of matched visual field results despite an 81% sensitivity for visual field detection by Damato campimetry largely relates to 30 eyes which showed visual field defect on both assessments but the defect occurred in completely different areas in each assessment, i.e. defects in different quadrants. If relying on results of Damato campimetry alone, it must therefore be taken into consideration that false positive responses arise with the assessment and to arrange further assessment of the patient to recheck the presence of visual field deficit. This is recommended for obtaining confirmation of visual field deficit by any perimetry method¹².

We included Humphrey perimetry results for comparison to Damato results where low reliability of greater than 20% was recorded on the result. We included this data as a pragmatic evaluation of whether the results were a match or not as low reliability results are seen frequently in visual field clinics. In comparison to the entire matching analysis, a complete or partial match was found in 65% of this sub group with 35% showing no match of visual field result. This was comparable to the matching results of the entire set of results.

On the basis of our results and their comparison to results reported in the literature we propose that the Damato campimeter is a suitable assessment for the quantitative assessment of visual field in a

population such as ward-bound in-patients in whom assessment must, by necessity, be undertaken on the ward. Indeed sensitivity and specificity may improve further because of the dense nature of visual field defects in conditions such as cerebrovascular accident – a fact that has been reported using confrontation methods¹³. Our study included patients with non-glaucomatous diagnosis in 42 eyes and assessment was done in out-patient clinics which therefore limits our interpretation of this data. Further research is required to evaluate this hypothesis whereby a larger sample of ward bound patients is assessed at different time points to determine detection and repeatability of Damato campimetry. In addition, further research may establish whether the Damato campimeter may also be a useful tool for visual field assessment in other clinic patient groups such as those with mobility or posture difficulties which prevents them undertaking quantitative perimetry and those ‘intimidated’ by the procedure of Humphrey perimetry in a darkened room, given that the Damato test is performed in ambient lighting in ‘free space’.

REFERENCES

1. Rowe FJ. Visual fields via the visual pathway. Blackwell Publications 2007
2. Pandit RJ, Gales K, Griffiths PG. Effectiveness of testing visual fields by confrontation. Lancet. 2001; 358: 1339-1340
3. Damato BE. Oculokinetic perimetry: a simple visual field test for use in the community. British Journal of Ophthalmology. 1985; 69: 927-931
4. Mutlukan E, Damato BE, Tavadia SM. Clustering of fixation targets in multifixation campimetry. Eye 1993; 7: 131-133

5. Yamada N, Chen PP, Mills RP, Leen MM, Lieberman MF, Stamper RL, Stanford DC. Screening for glaucoma with frequency-doubling technology and Damato campimetry. *Archives of Ophthalmology*. 1999; 117: 1479-1484
6. Wishart PK. Oculokinetic perimetry compared with Humphrey visual field analysis in the detection of glaucomatous visual field loss. *Eye* 1993; 7: 113-121
7. Damato BE, Chyla J, McClure E, Jay JL, Allan D. A hand held OKP chart for the screening of glaucoma: preliminary evaluation. *Eye* 1990; 4: 632-637
8. Vernon SA, Quigley HA. A comparison of the OKP visual field screening test with the Humphrey field analyser. *Eye* 1992; 6: 521-524
9. Cassidy TP, Bruce DW, Gray CS. Visual field loss after stroke: confrontation and perimetry in the assessment of recovery. *Journal of Stroke and Cerebrovascular Disease*. 2001; 10: 113-117
10. Taravati P, Woodward KR, Keltner JL, Johnson CA, Redhine D, Carolan J, Huang CQ, Wall M. Sensitivity and specificity of the Humphrey matrix to detect homonymous hemianopia. *Investigative Ophthalmology and Vision Science*. 2008; 49: 924-928
11. Wall M, Brito CF, Woodward KR, Doyle CK, Kardon RH, Johnson CA. Total deviation probability plots for stimulus size V perimetry. *Archives of Ophthalmology*. 2008; 126: 473-479
12. Tafreshi A, Sample PA, Liebmann JM, Girkin CA, Zangwill LM, Weinreb RN, Lalezary M, Racette L. Visual function-specific perimetry to identify glaucomatous visual loss using three different definitions of visual field abnormality. *Investigative Ophthalmology and Vision Science*. 2009; 50: 1234-1240

13. Johnson LN, Baloh FG. The accuracy of confrontation visual field test in comparison with automated perimetry. *Journal National Medical Association*. 1991; 83: 895-898

Figure 1 Damato 60-point campimeter (Precision Vision™, USA)

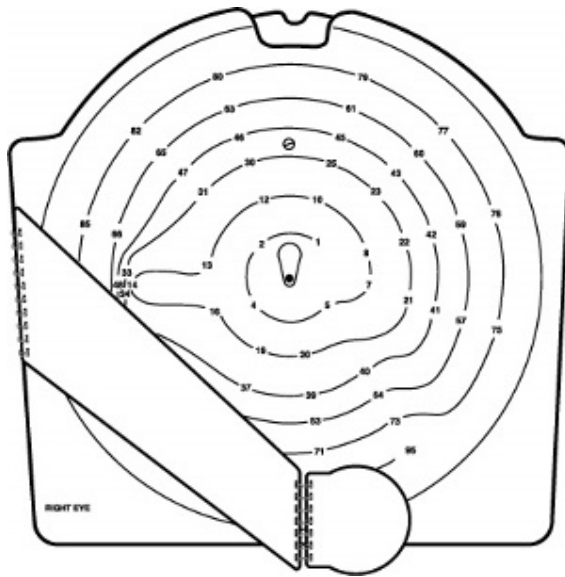
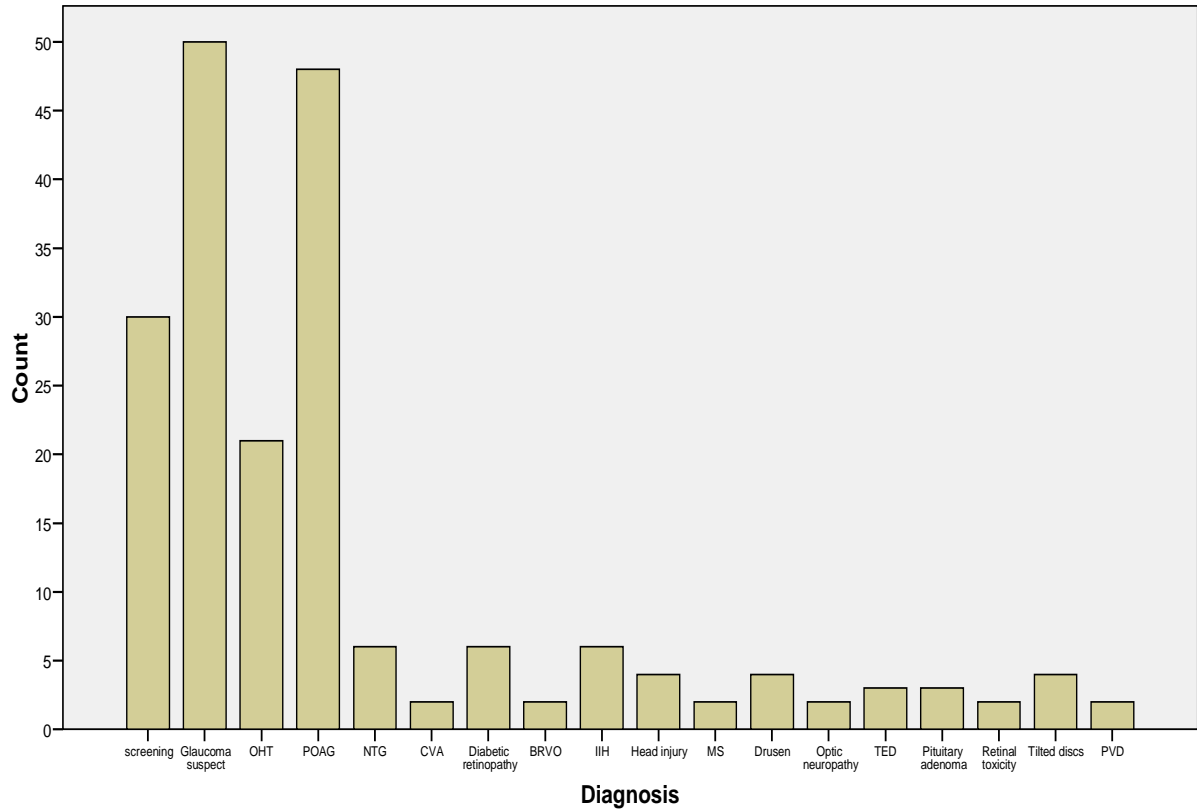

Figure 2 Diagnoses



OHT Ocular hypertension

POAG Primary open angle glaucoma

NTG Normal tension glaucoma

CVA Cerebrovascular accident

BRVO Branch retinal vein occlusion

IIH Idiopathic intracranial hypertension

MS Multiple sclerosis

TED Thyroid eye disease

PVD Posterior vitreous detachment

Figure 3 Flow chart for visual field assessment

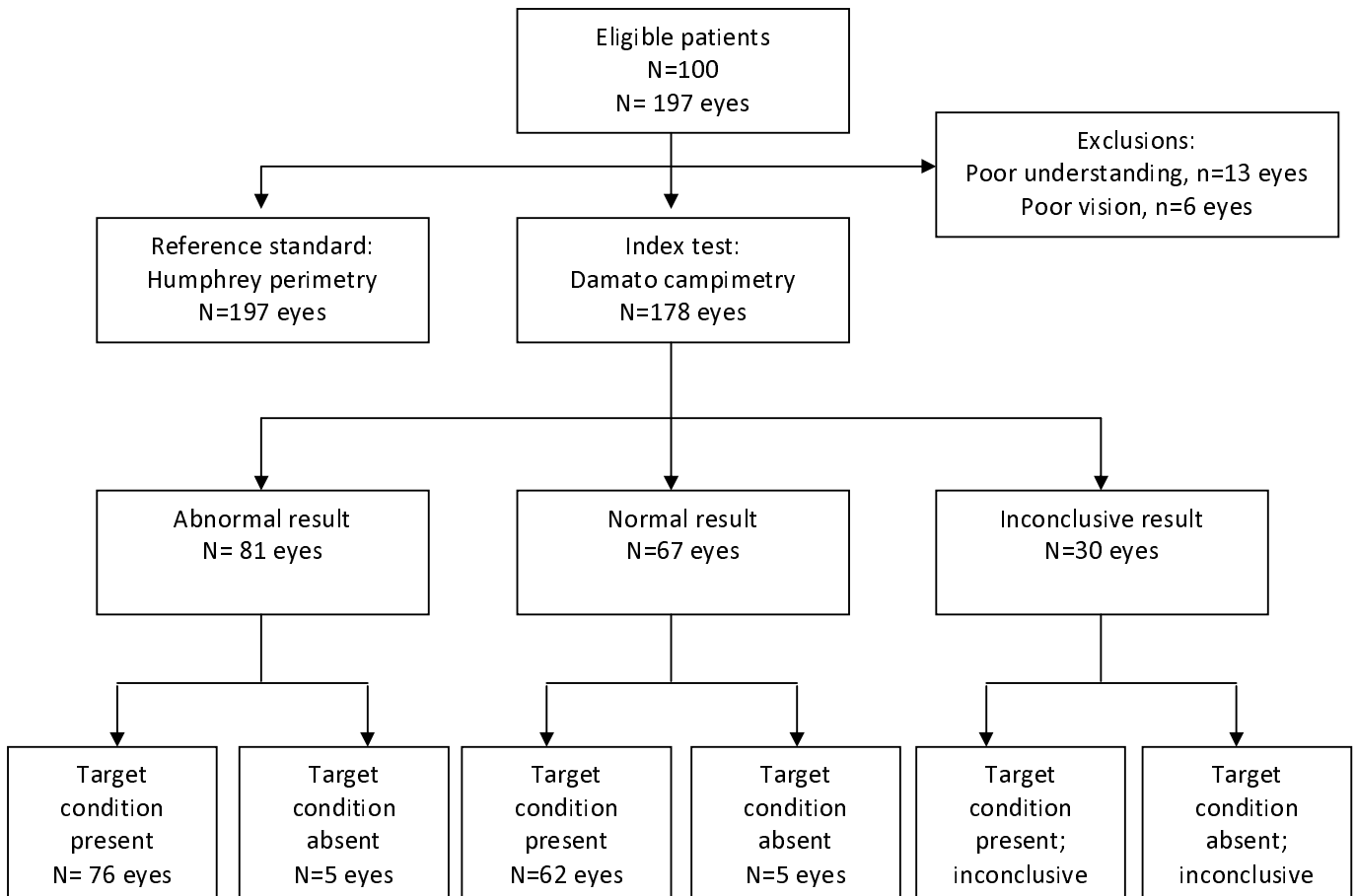
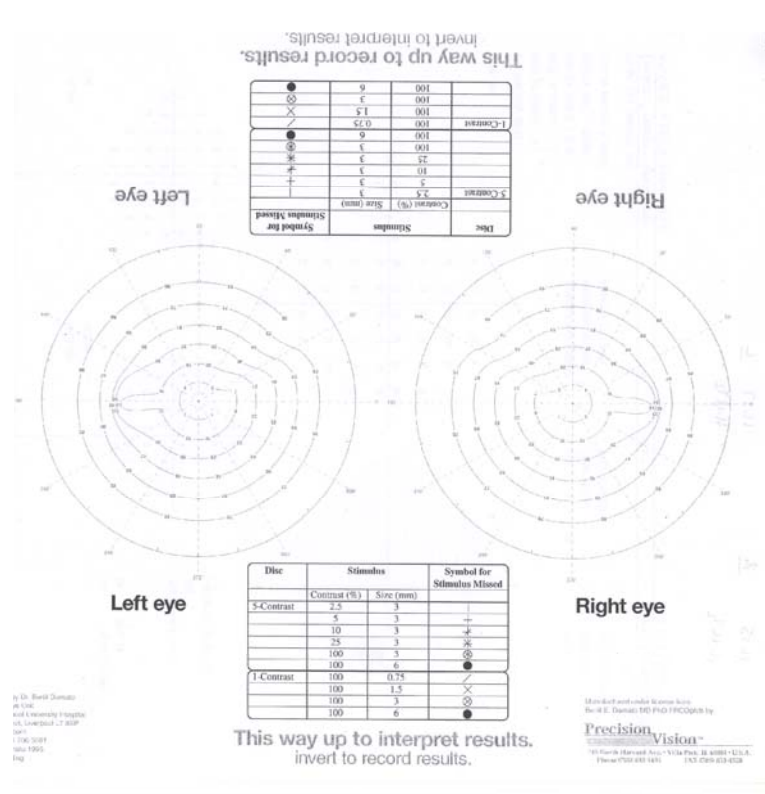
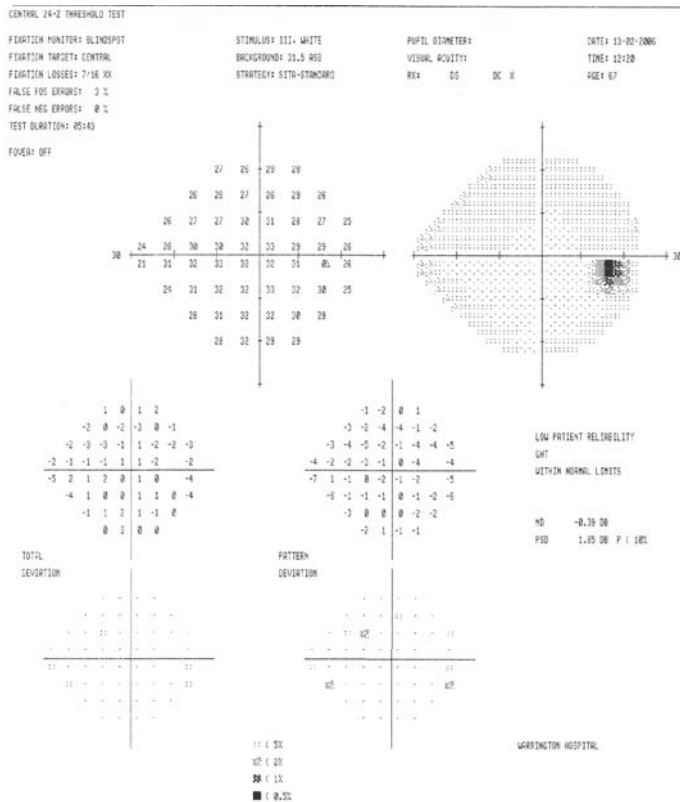

Figure 4 Matching analysis

A Match

Humphrey perimeter total deviation plot shows no deficits.

Damato campimetry chart shows no misses.



B Partial match

Humphrey perimeter total deviation plot shows considerable $p < 1\%$ deficits including the central field but less in the superior nasal field.

Damato campimetry chart shows considerable misses but also in the superior nasal field with none in the central field.

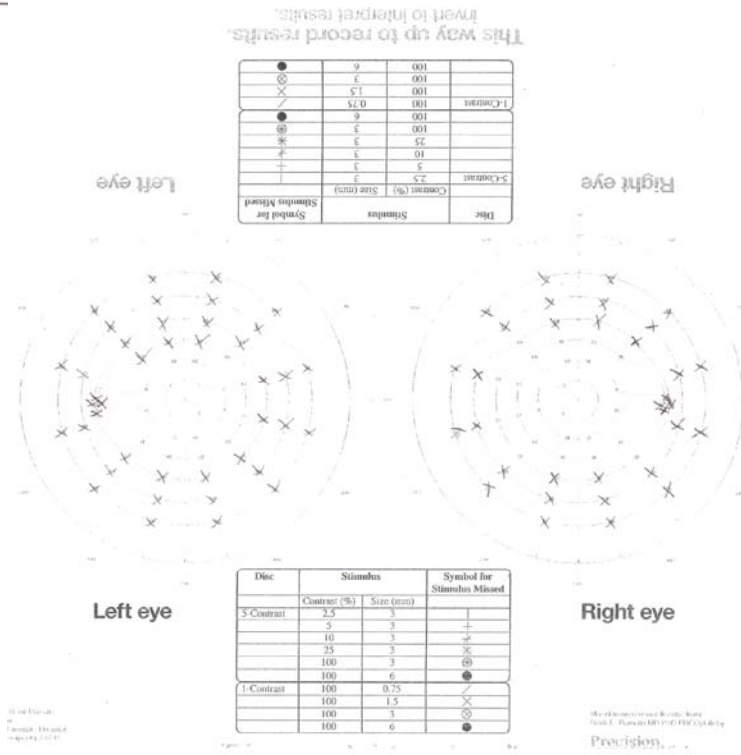
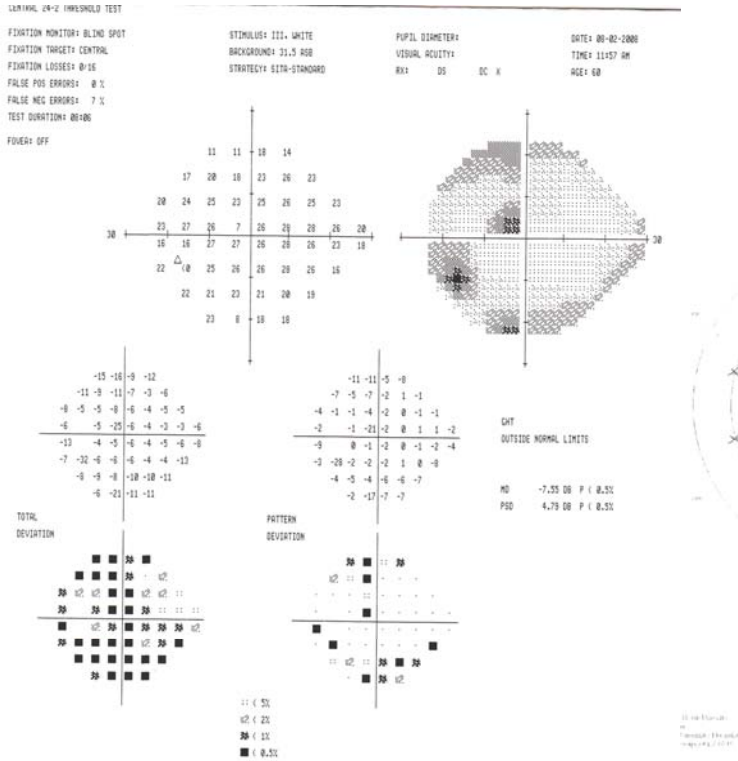

C Non match

Humphrey perimeter total deviation plot shows deficits, predominantly in the inferior field.

Damato campimetry chart shows no misses.

