



HAL
open science

The PSEN1 I143T mutation in a Swedish family with Alzheimer disease: Clinical report and quantification of $A\beta$ in different brain regions

Caroline Graff, Lina Keller, Hedvig Welander, Huei-Hsin Chiang, Lars O Tjernberg, Inger Nennesmo, Åsa K Wallin

► To cite this version:

Caroline Graff, Lina Keller, Hedvig Welander, Huei-Hsin Chiang, Lars O Tjernberg, et al.. The PSEN1 I143T mutation in a Swedish family with Alzheimer disease: Clinical report and quantification of $A\beta$ in different brain regions. *European Journal of Human Genetics*, 2010, 10.1038/ejhg.2010.107 . hal-00555618

HAL Id: hal-00555618

<https://hal.science/hal-00555618>

Submitted on 14 Jan 2011

HAL is a multi-disciplinary open access archive for the deposit and dissemination of scientific research documents, whether they are published or not. The documents may come from teaching and research institutions in France or abroad, or from public or private research centers.

L'archive ouverte pluridisciplinaire **HAL**, est destinée au dépôt et à la diffusion de documents scientifiques de niveau recherche, publiés ou non, émanant des établissements d'enseignement et de recherche français ou étrangers, des laboratoires publics ou privés.

The *PSEN1* I143T mutation in a Swedish family with Alzheimer disease: Clinical report and quantification of A β in different brain regions

Lina Keller^{1†}, Hedvig Welanders^{2†}, Huei-Hsin Chiang¹, Lars O. Tjernberg², Inger Nennesmo³, Åsa K Wallin⁴ and Caroline Graff^{1,2,5}.

¹Karolinska Institutet, Department of Neurobiology, Care Sciences and Society (NVS), KI-Alzheimer Disease Research Center, Novum, SE-141 86 Stockholm, Sweden. Phone: +46858583619. Fax: +46858583645.

²Karolinska Institutet, Department of Neurobiology, Care Sciences and Society (NVS), KI-Alzheimer Disease Research Center, KASPAC, Novum, SE-141 57, Huddinge, Sweden. Phone: +46858583622. Fax: +46858583610.

³Karolinska Institutet, Department of Laboratory Medicine, Division of Pathology, Karolinska University Hospital, SE-141 86 Stockholm, Sweden. Phone: +46858587846. Fax: +46-8-585 877 30.

⁴Clinical Memory Research Unit, Department of Clinical Sciences, Malmö, Lund University, Sweden. Phone: +4640335519. Fax: +4640335654.

⁵Department of Geriatrics, Genetics Unit, Karolinska University Hospital Huddinge, SE-141 86, Stockholm, Sweden. Phone: + 46858583619. Fax: +46858583645.

†L. K. and H. W. contributed equally to this work.

Running title: A β variants in brains from *PSEN1* mutation-carriers

Corresponding author: Caroline Graff: caroline.graff@ki.se

Karolinska Institutet, Department of Neurobiology, Care Sciences and Society (NVS), KI-Alzheimer Disease Research Center, KASPAC, Novum, SE-141 86 Huddinge, Sweden.

Abstract

Early onset dominantly-inherited forms of Alzheimer disease are rare, but studies of such cases have revealed important information about the disease mechanisms. Importantly, mutations in *APP*, *PSEN1* and *PSEN2*, alter the APP processing and lead to an increased amyloid β -peptide ($A\beta$) 42/40 ratio. This, together with other studies on the pathogenic mechanisms, show that $A\beta_{42}$ is a major player in the etiology of Alzheimer disease. Here we present a clinical and neuropathological description of a Swedish family with an I143T mutation in the *PSEN1* gene, which gives rise to a severe form of Alzheimer disease. We also performed an extensive investigation of the concentration and distribution of $A\beta$ species of different lengths in six brain regions from two mutation-carriers. Our study showed that $A\beta_{42}$ and a longer peptide, $A\beta_{43}$, were present both in plaque cores and in total amyloid preparations, and were each clearly more frequent than $A\beta_{40}$ in all examined regions, as shown by both mass spectrometry and immunohistochemistry.

KEYWORDS: Alzheimer disease, *PSEN1* mutations, amyloid β -peptide variants, mass spectrometry, neuropathology.

Introduction

Alzheimer disease (AD) is a neurodegenerative disorder and a major cause of dementia characterized by amyloid β -peptide ($A\beta$) deposits and neurofibrillary tangles in brain¹⁻³. Amyloid β -peptide ($A\beta$) is typically 40 or 42 amino acids long and is produced by the sequential cleavages of the amyloid precursor protein (APP) by β -secretase and γ -secretase⁴. The presenilins (1 and 2) are important components of the γ -secretase complex, and harbours its active site and thereby influences its proteolytic effect. $A\beta_{40}$ is produced at higher levels, but since $A\beta_{42}$ is more hydrophobic and has a stronger tendency to polymerize into neurotoxic species, it seems to be of particular importance in AD pathogenesis⁵⁻⁷. This is supported by studies on mutations in *APP*, presenilin 1 (*PSEN1*) and presenilin 2 (*PSEN2*) which show an increased $A\beta_{42}/40$ ratio⁸. Five mutations have previously been described in families from Sweden: two mutations in *APP* (the *APP* Swedish⁹- and the *APP* Arctic mutations¹⁰) and three in *PSEN1* (M146V, H163Y¹¹ and R269H¹²). In the present study we describe the clinical characteristics of a three-generational Swedish family found to have the I143T *PSEN1* mutation, which causes a rapidly progressing type of early onset AD (EOAD). This mutation is prone to produce $A\beta$ peptides of different lengths¹³. We recently reported that a longer variant, $A\beta_{43}$, is present in plaque cores and total amyloid preparations obtained from sporadic and familial AD brains, and was indeed found more frequently than $A\beta_{40}$ ¹⁴. A quantitative approach was used to study $A\beta_{40}$, $A\beta_{42}$, and $A\beta_{43}$ in two mutation-carriers diagnosed with a severe and aggressive form of EOAD by examining samples taken from 6 brain regions, including: frontal, parietal, temporal, and occipital cortex; as well as anterior hippocampus and

cerebellum. High performance liquid chromatography (HPLC) coupled with an electrospray ionization (ESI) ion trap mass spectrometer (MS) was used. In parallel, we performed immunohistochemistry on consecutive sections using antibodies directed against A β 40, A β 42 and A β 43. In addition, secreted and cellular A β was analysed in cultured fibroblasts from mutation-carriers and controls using a highly sensitive ELISA.

Materials and methods

The study was approved by the Regional Ethical Committee in Stockholm and informed consent was obtained from the participants, or a proxy.

Sample preparation for neuropathological examination and immunohistochemistry

The left-halves of the brains were frozen after death and the right-halves fixed in 4% formaldehyde. Samples from the different regions; hippocampus, amygdala, basal ganglia, thalamus, mesencephalon, brainstem and cerebellum, were collected from the fixed brains. In addition, one gross section of the cerebral hemispheres was collected from each patient. Staining was performed on 5 μ m thick formaldehyde-fixed paraffin-embedded sections. Sections were routinely stained with hematoxylin and eosin, Luxol fast blue, Bielschowsky and AT8 antibody. Some sections were also Congo stained to detect amyloid. Immunohistochemistry was performed on sections pre-treated with formic acid (FA) (88 %) for 10 min. Staining was performed using a C-terminal specific antibody diluted in Bond™ primary antibody diluents (Vision BioSystems Limited, Newcastle Upon Tyne, United Kingdom), 1:4000 for A β 40 (BioSource, Camarillo, CA, USA), 1:50 for A β 42 (BioSource, Camarillo, CA, USA) and 1:8000 for A β 43 (GeneTex, Irvine, CA, USA).

Preparations were visualized in a Bond™ Polymer Refine Detection system (Vision BioSystems Limited, Newcastle Upon Tyne, United Kingdom). The specificity of the A β 43 antibody was tested as previously described¹⁴.

Molecular genetics

DNA was extracted from peripheral blood (cases III:1 and III:2), or from formalin-fixed paraffin-embedded tissue (case II:2). The *PSENI* gene exons 2-11, the coding part of exon 12 and at least 40 flanking nucleotides were sequenced in both directions using an ABI 3100 genetic analyzer and ABI PRISM® BigDye® Terminator v3.1 Cycle Sequencing Kit (Applied Biosystems, Foster City, USA) with primer pairs available upon request. The restriction enzyme Tsp45 (New England Biolabs, Ipswich, MA, USA) was used to confirm the presence of the mutation. The *APOE* genotype for case III:2 was obtained by the SNaPshot multiplex system (Applied Biosystems, Foster City, USA), while the genotypes for III:1 and II:2 were obtained from medical records.

Plaque core preparations

Plaque cores obtained from frozen frontal, parietal, temporal, and occipital cortex, as well as from anterior hippocampus and cerebellum were prepared using the same procedure as described in Welander et al.⁴. Initially, 0.5-1 g of brain tissue was homogenised in Tris-buffered saline (TBS), pH 7.4 supplemented with Complete™ protease inhibitor mixture (Roche Applied Science, Basel, Switzerland) (4 mL buffer/g of tissue) using a mechanical pestle-homogeniser (IKALabortechnik RW20, IKA Labortechnik, Staufen, Germany). The homogenate was centrifuged at 4,000 \times g for 2 min at 4 °C and the resulting pellet was then washed in TBS and stained overnight with Congo red (50% saturated in TBS). The pellet was filtered through a 100- μ m nylon mesh (Millipore Corporation, Bedford, MA, USA),

adjusted to 46% sucrose and centrifuged at $16,000 \times g$ for 1 h at 4 °C, then followed by one more centrifugation of the pellet at $16,000 \times g$ for 5 min at 4 °C and dilution in 1% SDS in TBS. After filtration through a 60- μm nylon mesh (Millipore Corporation, Bedford, MA, USA) and centrifugation at $16,000 \times g$ for 5 min at room temperature (24 °C), the pellet was washed three times in TBS buffer and centrifuged at $16,000 \times g$ for 5 min at room temperature (24 °C). The final pellet was stored at -20 °C.

Preparation of SDS-insoluble brain homogenates

A previously described protocol for SDS preparations was followed¹⁴. In brief, the samples were homogenised as described above. The homogenate was centrifuged at $50,000 \times g$ for 1 h, the resulting pellet was re-homogenised in TBS with 1% SDS and centrifuged at $50,000 \times g$ for 1 h. This procedure was repeated three times. The final pellet was washed five times in TBS and stored at -20 °C.

Dissolution and cleavage of brain samples

The purified plaque cores as well as pellets from the SDS preparations were dissolved in a shaker at 600 rpm over-night at 37 °C in 80% FA and 4 mg of cyanogen bromide (CNBr). CNBr cleaves C-terminally of methionine (generating A β 36-x fragments). Samples were prepared for LC-MS/MS analysis by concentrating and desalting the samples using C 18 ZipTips (Millipore Corporation, Bedford, MA, USA) according to manufacturer's instructions, and then dried in a vacuum centrifuge (Maxi dry lyo, Heto, Alleröd, Denmark) and dissolved in 40 μL of 0.1% FA. Finally, 0.5 μL of the plaque core samples and the SDS preparations were injected into the LC-MS/MS-analysis system.

Quantification

The synthetic A β peptides A β 36-40, A β 36-42 and A β 36-43 (Bachem, Basel, Switzerland) were used as standards for quantifications as described previously¹⁴. The peptides were dissolved in 80% FA and diluted in 0.1% FA. Standard curves were created by mixing A β 36-40, A β 36-42 and A β 36-43 at a ratio of 20:20:1, and injecting 1 μ L of 500, 200, 50 and 20 fmoles of A β 36-40 and A β 36-42 and 25, 10, 2.5 and 1 fmoles of A β 36-43 in the same solution. The monoisotopic masses for the A β fragments were plotted as extracted ion chromatograms. The peak areas were used in the equations from the standard curves in order to calculate the concentrations of A β in the tissue samples, which were expressed as nmol A β /g of wet brain tissue. The total CNBr cleavage yield was taken into account in the calculations as well as the yield from the plaque core preparation procedure as established previously¹⁴.

HPLC-MS/MS

The samples were injected into a high-capacity enrichment column chip with a 160 nL enrichment column and a 75 μ m \times 150 mm analytical column packed with Zorbax C18-SB 5 μ m material. As described before¹⁴, peptides were eluted using a water/acetonitrile (ACN) gradient supplemented with 0.2% FA, from 2% to 14% ACN in 20 min and from 14 to 95% ACN in 20 min. The flow rate was 0.4 μ L/min, delivered by an Agilent 1200 nano pump (Agilent Technologies, Santa Clara, CA, USA). The column chip was coupled to an Agilent ion trap mass spectrometer (Agilent Technologies, 6330 Ion Trap LC/MS). Mass spectra were recorded from mass to charge ratio (m/z) 420 to m/z 750. Identity was confirmed using MS/MS data.

Fibroblast culture

Skin biopsy samples were taken and fibroblast cells were prepared as described¹⁵. Fibroblast cell cultures from case III:1 were compared with selected cases, including an individual with the *APP* KM670/671NL Swedish mutation (*APP*^{Sw}) (onset age 58, biopsy at 66 years), and three unrelated, gender-matched and cell-passage-matched controls (mean age at biopsy: 43.7 years; range 26-53 years). Measurements of secreted and cellular A β 40 and A β 42 using ELISA provided the basis for comparison. The fibroblast cells were cultured in duplicate in 5 mL Minimum Essential Medium with Earl's salt (MEM), supplemented with 7.5% heat inactivated fetal bovine serum (FBS), 10mM HEPES, 1.2% L-glutamine, and 1.2% penicillin-streptomycin (all reagents from GIBCO[®], Invitrogen, Carlsbad, California, USA). In parallel, fibroblast samples from the I143T, the *APP*^{Sw} and two of the controls were also cultured in the presence of the γ -secretase inhibitor L-685.485 (Bachem, Bubendorf, Switzerland) at a final concentration of 10 μ M until collection of the cell medium. When the cells reached ~100% confluency the cell medium was replaced with serum-free MEM, supplemented with 10 mM HEPES and 1.2% L-glutamine, and incubated for 24 h; after which Complete[™] protease inhibitor cocktail (Roche Applied Science, Basel, Switzerland) was added to the cell culture. The medium was removed, aliquoted in Genuine Axygen Quality 1.5 ml microtubes (Axygen INC, Union City, USA) and stored at -80 °C for future analysis. The remaining cells were treated with 1 mL 1 \times RIPA (150 mM NaCl, 1% NP-40, 0.5% deoxycholic acid, 0.1% SDS, 50 mM Tris, pH8) containing Complete[™] protease inhibitor cocktail (Roche Applied Science, Basel, Switzerland), and harvested by scraping on ice. The cells were collected in Genuine Axygen Quality 1.5 ml microtubes (Axygen INC, Union City, US) and centrifuged at

25 000 x g for 1 h at 4 °C. The cell pellet and the supernatant (sup1) were stored at -80 °C for future analysis.

ELISA

A β 40 and A β 42 secreted into the cell medium and cellular (RIPA soluble) A β 40 and A β 42 were measured in triplicates by ELISA (Human/Rat β Amyloid (40) ELISA Kit Wako II and Human/Rat β Amyloid (42) ELISA Kit Wako, High-Sensitive from WakoPure Chemical Industries, Ltd. Osaka, Japan). Since the levels of secreted A β 40 were below the detection limit for the Wako kit, secreted A β 1-40 in the medium was instead analyzed using the Human Amyloid β (1-40) (FL) Assay Kit - IBL (IBL International GmbH, Hamburg, Germany). FLUOStar Galaxy (Thermo Scientific, Fremont, CA, USA) was used to measure fluorescence. Before the cell medium samples and standards were loaded on the ELISA plate, 5 \times RIPA was added to a final concentration of 1 \times RIPA. For the cell pellets, 200 μ l 1 \times RIPA was added to the pellet and sonicated for 10 min, followed by centrifugation at 25 000 x g for 1 h at 4 °C, generating supernatant 2 (sup 2). Sup 1 and 2 were pooled; the pooled samples thus contained all of the 1 \times RIPA soluble cellular A β , before loading on to the ELISA plate. The ELISA procedure was according to manufacturer's protocol, except that TMB was exchanged with a 1 \times PBS solution containing 50 μ M Amplex[®] UltraRed reagent (Invitrogen, Eugene, Oregon, USA); and 2.2 mM H₂O₂ was added to each well before measuring the fluorescence which was done using a 544 nm-excitation filter and 590

nm-emission filter effectively increasing sensitivity. Concentrations of A β 40 and A β 42 secreted into the cell medium and RIPA soluble cellular samples (sup 1 and sup 2) were calculated from standard curves. The mean A β concentration was then normalized against the total cellular protein concentration measured with the Pierce BCA Protein Assay Kit (Thermo scientific, Rockford, USA) according to manufacturer's protocol.

Results

Clinical characteristics

In a Swedish family five family members across three generations were affected with pre-senile dementia (Figure 1). The age of onset was 35.6 ± 2.1 years (mean \pm SD) and age at first AD-related medical visit was 36.2 ± 1.9 years-of-age. The mean age of death was 42.4 ± 1.3 years and the duration of the disease from onset to death was 6.8 ± 2.4 years. Initial symptoms were typical for AD and included memory impairment, visuospatial difficulties, disorientation, dyspraxia and dysphasia. However, these symptoms were not always reported until the patient was admitted to hospital acutely due to falls or epileptic seizures. Additional early findings were coordination difficulties associated with gradually increasing myoclonic jerks, multiple falls, and in some cases epileptic seizures. These neurologic symptoms made differential diagnosis difficult, specifically in the case between AD and Huntington disease. The latter diagnosis was excluded, however, by genetic testing. In the later stages of the disease psychiatric symptoms such as paranoid delusions, hallucinations and aggressiveness appeared and, in the first generation, Pick disease was suspected due to the noted personality changes. Within the youngest generation cholinesterase inhibitor treatment was tried but appeared not to slow the rapid progression

of the disease. Antiepileptic treatment appeared to reduce myoclonic jerks. For an overview of the clinical presentation see Supplementary Table 1; and for a detailed description of the symptoms, clinical course and treatment of the family members see the Supplementary Text 1.

Neuropathological examination

Brains from three mutation-carriers (cases II:2, III:2 and III:1) were subject for autopsy. A definite diagnosis of AD was established for cases III:1 and III:2 according to CERAD criteria, and Braak stage VI. Case II:2 was diagnosed as Atypical Alzheimer disease in 1985, due to the prominence of pathology associated with the corpus striatum, not typically seen in AD cases. However, a recent re-examination revealed severe AD pathology. In summary, all brains were severely affected by Alzheimer pathology and atrophy. Macroscopically, the frontal lobes were especially affected by thinning of gyri and reduced cortical thickness, while microscopically a large number of plaques were observed, often without a distinct plaque core. Tau pathology, including numerous ghost tangles, was widespread and severe in the hippocampal areas, entorhinal cortex and amygdala. Superficial spongiform changes and gliosis were present. Interestingly, some neurons in the granular cell layer of the dentate gyrus were immunoreactive for the AT8 antibody, which recognizes phosphorylated tau. The cerebellum, which often is relatively spared in AD, was clearly affected by amyloid in cases III:1 and III:2. For a detailed neuropathological description see Supplementary Text 2.

Molecular genetics- Identification of the pathogenic mutation

The family showed a clear pattern of dominantly-inherited neurodegenerative disease; and the neuropathological investigation of case III:2 prompted us to suspect early-onset AD and

to screen for a mutation in *PSENI*. A heterozygous point-mutation was found in the second base in codon 143 of exon 5 in *PSENI*, which results in an amino acid exchange from isoleucine (I) to threonine (T) in the second transmembrane region of the presenilin 1 protein. Restriction enzyme cleavage of the exon 5 PCR-fragment using Tsp45 I resulted in two extra and shorter bands in addition to the 300 bp long wild-type fragment thereby confirming the presence of the I143T mutation (data not shown). The mutation was detected in genomic DNA from each of the three cases: II:2, III:1 and III:2 (Figure 1). Moreover, one variation was found in intron 8 (rs165932) that has previously been studied (<http://www.alzgene.org/meta.asp?geneID=84>). This variation is a common polymorphism and should not be considered as informative. No other genetic variation was found. Cases II:2, III:1 and III:2 were all *APOE* $\epsilon 3\epsilon 3$ homozygotes.

Analysis of A β C-terminal fragments in plaque cores and SDS-insoluble material

By using LC-MS, we quantified the amount of different A β C-terminal variants in plaque cores and total amyloid SDS-insoluble material from frontal, parietal, temporal, and occipital cortex; as well as anterior hippocampus and cerebellum of two *PSENI* I143T mutation-carriers (cases III:1 and III:2, Figure 1). Standard curves were created and used for calculations of the A β concentrations (Figure S1A, S1B and S1C, supplementary data). In plaque cores, A β x-42 was readily detected in all regions from both patients. The lowest concentration was found in the cerebellum, and the highest in the occipital cortex. A β x-43 was found in all regions from both cases, except for the cerebellum where it was not detected. In both cases, the highest concentration was found in the occipital cortex.

Interestingly, A β x-40 was not detected in any of the regions obtained from the two cases (Figure 2A).

We also analyzed total A β in SDS-insoluble material from brain homogenates. A β x-42 was readily detected in all regions in both patients. The lowest concentrations of A β x-42 were found in the cerebellum, while the highest concentrations were found in the occipital cortex. A β x-43 was readily detected in all regions from both cases, (Figure 2B). Interestingly, A β x-40 was detected only in occipital cortex and cerebellum of case III:2.

Immunohistochemistry

Antibodies specific for the C-terminus of A β x-40, A β x-42 or A β x-43 were used to stain consecutive sections taken from the six regions of the two cases. The staining of A β x-40 was low in the occipital cortex in both cases, and only detected in vessels (Figure 3A, 3D); whereas A β x-42 staining was intense in both cases with numerous immunoreactive plaques (Figure 3B, 3E). Many immunoreactive plaques were also evident by the A β x-43 antibody (Figure 3C, 3F). Although the methodology used does not allow for quantification and co-localization of the immunoreactivity, visual inspection in the microscope revealed that A β x-42 and A β x-43 immunoreactivity was detected in both plaques and vessels, whereas A β x-40 showed immunoreactivity mainly in vessels (Figure 3G, 3H, 3I). In the cerebellum, A β x-40 staining was clearly visible only in a few vessels, most prominently in case III:2 (Figure 3J, 3M). A β x-42 staining was observed in vessels in both cases (Figure 3K, 3N). A β x-43 staining was positive in vessels and the pattern was similar to the A β x-42 staining in both cases (Figure 3L, 3O). Moreover, extracellular A β x-42 and A β x-43 staining was also observed in an uneven and diffuse pattern in the molecular layer.

The immune staining of frontal, temporal and parietal cortex, as well as hippocampus showed little or no A β x-40 immunoreactivity, and when present was only observed in vessels, a pattern seen also in the occipital cortex and the cerebellum. A β x-42 was positive in both plaques and vessels and A β x-43 appeared to have a similar staining pattern (data not shown) in these four regions.

A β production in cultured fibroblasts from mutation-carriers and controls

As a complement, a sensitive ELISA was implemented to measure A β production in cultured fibroblasts. Results showed that secreted A β 40 levels were low in both the *PSENI* I143T mutation-carrier (case III:1) and the healthy controls (less than 5 pmol/g total protein), although the level was five times higher in the *APPSwe* carrier (~25 pmol/g total protein). Secreted A β 42 levels were also low (\leq 1 pmol/g total protein) and equal in all samples, except the *APPSwe* mutation-carrier, in which the concentration was about three times higher (2.8 pmol/g total protein). In the presence of the γ -secretase inhibitor, L-685.485, no A β was detected (data not shown). The ratio of secreted A β 42/40 was highest in the *PSENI* I143T carrier (0.5) (Figure 4A).

The cellular A β 40 concentration was equivalent in all samples (40-55 pmol/total protein), and significantly higher when compared to secreted A β 40 (about two times higher in the *APPSwe* carrier, and up to 50 times higher in the *PSENI* I143T mutation-carrier and the healthy controls). The cellular A β 42 concentration was higher across all samples (~8 pmol/g total protein) than was secreted A β 42 (0.5-2.8 pmol/g total protein). Therefore, the cellular ratio of A β 42/40 was similar (0.14-0.16) across all samples (Figure 4B). No significant inhibition of A β was detected in the presence of the γ -secretase inhibitor, L-685.485 (data not shown).

Discussion

In the present study, we identified a *PSEN1* I143T mutation in three cases diagnosed with neurodegenerative disease from two generations in a Swedish family. This mutation has previously been reported to cause EOAD in four single unrelated cases, as well as three siblings and two families in which segregation was proven, but clinical, neuropathological and biochemical details have been lacking¹⁶⁻²³. The form of EOAD recurring in this family is severe, and its mean onset age is reported to be 34 years, while mean age-of-death is 41.2 years (<http://www.molgen.ua.ac.be/ADMutations>). Our clinical investigation revealed an aggressive form of AD with rapid progression and extensive myoclonia. Among the clinical characteristics demonstrated in this Swedish family were; insidious impairment of memory, visuospatial disorientation, dyspraxia and dysphasia as well as coordination problems, including: myoclonic jerks and multiple falls, and in some cases epileptic seizures. The clinical characteristics of the Belgian family with the same mutation, described as early as in 1940 as “une observation hérédo-familiale de démence avec épilepsie et clonismes”^{16, 18, 24} were similar to the characteristics of the Swedish family in terms of age at onset, increased aggressiveness, rapid loss of memory, myoclonus and seizures.

We performed quantitative and qualitative biochemical studies of A β pathology on six brain regions sampled from two cousins known to have the I143T mutation. Interestingly, we found that a long A β species, ending at Thr43, was present in plaque cores in all regions except in cerebellum. In all analyzed regions A β x-43 was found more frequently than A β x-40, shown by both mass spectrometry analysis and immunohistochemistry. The highest concentrations of both A β x-42 and A β x-43 were found in occipital cortex from both

mutation-carriers. This supports the notion that the occipital cortex is a plaque core rich region²⁵. Even though immunostaining in both cases showed that the cerebellum was affected by A β pathology, the lowest plaque core concentration of A β x-42 was found in preparations from this area, and moreover A β x-43 was not detected by mass spectrometry. The concentrations of A β x-42 were similar in frontal cortex and anterior hippocampus. The levels were higher in both parietal and temporal cortex than in either frontal cortex or anterior hippocampus. There were no significant differences in the concentration of A β x-43 between these regions. In accordance with earlier studies⁶, we conclude that A β 42 is the predominant species in amyloid plaque cores in the AD brain. Notably, there were no detectable levels of A β x-40 in plaque cores, which is in line with previous results⁶.

Since A β is not only deposited in plaque cores in the AD brain but also in the walls of the cerebral vessels and as diffuse deposits, we studied total A β from the two cases by analysing A β peptides in the material from SDS-insoluble preparations. A β x-42 and A β x-43 were readily detected in all regions. The concentrations were highest in the occipital cortex and lowest in the cerebellum. Interestingly, there were no detectable levels of A β x-40 in the SDS-insoluble preparations except in the cerebellum and the occipital cortex of case III:2. The levels of A β x-40 in these regions most likely stem from amyloid in cerebral vessels associated with cerebral amyloid angiopathy (CAA), which is reported to be composed mainly of A β x-40^{6,26}. Since A β x-40 has a lower aggregation propensity compared to the longer A β species, the differences in A β x-40 levels between the cases might be explained by the longer duration of the disease in case III:2, as compared with case III:1. The mass spectrometry data is also supported by the immunohistochemical

analysis of the six regions which showed that A β x-40 was localized mainly to the cerebral vessels, while A β x-42 and A β x-43 were more prominent in plaques.

Using ELISA, we measured the cellular and secreted A β 40 and A β 42 in cultured fibroblasts sampled from a *PSEN1* I143T mutation-carrier, an *APP^{Swe}* mutation-carrier and three healthy controls. The *APP^{Swe}* mutation-carrier differed notably with higher concentrations of secreted A β 40 and A β 42 compared to all other samples. Cellular A β 40 and A β 42 concentrations did not differ significantly between the samples and the levels of A β 42 were lower in comparison to A β 40. The highest ratio of A β 42/40 was observed in the secreted fraction from the I143T mutation-carrier, in line with previous studies on *PSEN1* mutations^{8,27}. Although the secreted A β was effectively inhibited in the presence of a γ -secretase inhibitor, the inhibition was not effective with respect to the cellular levels of A β . We do not know why the cellular levels of A β were not reduced by the γ -secretase inhibitor treatment; but one explanation might be the inability of the inhibitor to enter the human fibroblast cells.

The neurologic manifestations in this family are also prevalent in other EOAD²⁸ cases and is considered secondary to the neurodegenerative process. In the described family, all patients had some neurologic dysfunctions, such as falls, myoclonus or epileptic seizures. Experimental data indicates that high levels of A β in hAPP transgenic mouse-brains might cause epileptic activity and contribute to cognitive decline^{28,29}. We showed that the *PSEN1* mutation-carriers had severe A β pathology by both immunohistochemical staining and mass spectrometry analysis, which might have triggered the myoclonus and epileptic manifestations.

Since the A β 43 peptide is more hydrophobic than A β 42 and longer forms polymerize faster and at lower concentrations than the more abundant shorter variants, it is plausible that the A β 43 isoform also forms toxic oligomers to a greater extent than A β 40 and A β 42 *in vivo*. However, in post mortem studies, like this one, initiating events of the disease cannot be observed. Since A β oligomers seem to be of particular importance as neurotoxins, further studies of the presence of A β 43 oligomers are warranted. Furthermore, *in vivo*- and *in vitro* studies, focusing on A β 43 are encouraged, in particular with respect to the design of A β vaccination trials.

In summary, we identified an I143T *PSENI* mutation in a Swedish family, the sixth AD mutation found in Sweden that causes an aggressive form of EOAD. We also found a longer A β species, A β 43, which was present in each examined brain area, except for the cerebellum, which was, on the other hand, more extensively affected by A β 40. Although the absolute levels of A β 43 were low, it was clearly more frequent than A β 40, thus indicating that A β 43 has an important role in the disease process of AD.

Acknowledgements

First of all, we would like to express our sincere gratitude to the members of the family in our study. We are also thankful to Masakazu Hashimoto for sharing his knowledge about ELISA techniques. The study was financially supported by Alzheimer Foundation, Foundation for Old Servants, Gun and Bertil Stohne's Foundation, Swedish Brain Power, Marianne and Marcus Wallenberg Foundation, Knut and Alice Wallenberg Foundation and Dainippon Sumitomo Pharma (Japan).

Conflict of interest: The authors declare no conflict of interest.

References

- 1 Alzheimer A. Über eine eigenartige Erkrankung der Hirnrinde. *Allgemeine Zeitschrift für Psychiatrie und Psychisch-Gerichtliche Medizin* 1907; **64**: 146-148.
- 2 Glenner GG and Wong CW. Alzheimer's disease: initial report of the purification and characterization of a novel cerebrovascular amyloid protein. *Biochem Biophys Res Commun* 1984; **120**: 885-890.
- 3 Masters CL, Simms G, Weinman NA, Multhaup G, McDonald BL, Beyreuther K. Amyloid plaque core protein in Alzheimer disease and Down syndrome. *Proc Natl Acad Sci USA*. 1985; **82**: 4245-4249.
- 4 Selkoe DJ. Alzheimer's disease: genes, proteins, and therapy. *Physiol Rev* 2001; **81**: 741-766.
- 5 Hardy J and Selkoe DJ. The amyloid hypothesis of Alzheimer's disease: progress and problems on the road to therapeutics. *Science* 2002; **297**: 353-356.
- 6 Iwatsubo T, Odaka A, Suzuki N, Mizusawa H, Nukina N, Ihara Y. Visualization of A β 42(43) and A β 40 in senile plaques with end-specific A β monoclonals: evidence that an initially deposited species is A β 42(43). *Neuron* 1994; **13**: 45-53.
- 7 Jarrett JT, Berger EP and Lansbury PT Jr. The carboxy terminus of the β amyloid protein is critical for the seeding of amyloid formation: implications for the pathogenesis of Alzheimer's disease. *Biochemistry* 1993; **32**: 4693-4697.
- 8 Borchelt DR, Thinakaran G, Eckman CB, *et al*: Familial Alzheimer's disease-linked presenilin 1 variants elevate A β 1-42/1-40 ratio in vitro and in vivo. *Neuron* 1996; **7**: 1005-1013.

- 9 Mullan M, Crawford F, Axelman K, Houlden H, Lilius L, Winblad B *et al*: A pathogenic mutation for probable Alzheimer's disease in the APP gene at the N-terminus of beta-amyloid. *Nat Genet* 1992; **1**: 345-347.
- 10 Nilsberth C, Westlind-Danielsson A, Eckman CB *et al*: The 'Arctic' APP mutation (E693G) causes Alzheimer's disease by enhanced A β protofibril formation. *Nat Neurosci* 2001; **4**: 887-893.
- 11 Clark RF, Hutton M, Fuldner RA *et al*: The structure of the presenilin 1 (S182) gene and identification of six novel mutations in early onset AD families. Alzheimer's Disease Collaborative Group. *Nat Genet* 1995; **11**: 219-222.
- 12 Forsell L, Mattila KM, Axelman K, Lannfelt L. The Arg269His and Glu318Gly mutations in the presenilin-1 gene found in Swedish early onset Alzheimer's disease families. Abstract, Sixth International Conference on Alzheimer's Disease and Related Disorders, Amsterdam 1998;18-23 July.
- 13 Kumar-Singh S, Theuns J, Van Broeck B *et al*: Mean age-of-onset of familial alzheimer disease caused by presenilin mutations correlates with both increased A β 42 and decreased A β 40. *Hum Mutat* 2006; **27**: 686-695.
- 14 Welander H, Franberg J, Graff C, Sundstrom E, Winblad B, Tjernberg LO, A β 43 is more frequent than A β 40 in amyloid plaque cores from Alzheimer disease brains. *J Neurochem* 2009; **110**: 697-706.
- 15 Nagasaka Y, Dillner K, Ebise H *et al*: A unique gene expression signature discriminates familial Alzheimer's disease mutation carriers from their wild type siblings. *Proc Natl Acad Sci USA* 2005; **102**: 14854-14859.

- 16 Martin JJ, Gheuens J, Bruyland M, Cras P *et al*: Early-onset Alzheimer's disease in 2 large Belgian families. *Neurol* 1991; **41**: 62-68.
- 17 Arango D, Cruts M, Torres O *et al*: Systematic genetic study of Alzheimer disease in Latin America: mutation frequencies of the amyloid beta precursor protein and presenilin genes in Colombia. *Am J Med Genet* 2001; **103**: 138-143.
- 18 Cruts M, Backhovens H, Wang SY *et al*: Molecular genetic analysis of familial early-onset Alzheimer's disease linked to chromosome 14q24.3. *Hum Mol Genet* 1995; **4**: 2363-2371.
- 19 Cruts M, Van Broeckhoven C. Molecular genetics of Alzheimer's disease. *Ann Med* 1998; **30**: 560-565.
- 20 Miravalle L, Takao M, Glazier B, Piccardo P, Vidal R, Ghetti B. Genetic mutations associated with presenile dementia. *Neurobiol of Aging* 2002; **23**: Supplementary text page 322.
- 21 Raux G, Guyant-Marechal L, Martin C *et al*: Molecular diagnosis of autosomal dominant early onset Alzheimer's disease: an update. *J Med Genet* 2005; **42**: 793-795.
- 22 Rogaeva EA, Fafel KC, Song YQ *et al*: Screening for PS1 mutations in a referral-based series of AD cases: 21 novel mutations. *Neurology* 2001; **57**: 621-625.
- 23 Arai N, Kishino A, Takahashi Y *et al*: Familial cases presenting very early onset autosomal dominant Alzheimer's disease with I143T in presenilin-1 gene: implication for genotype-phenotype correlation. *Neurogen* 2008; **9**: 65-67.
- 24 van Bogaert L, Maere M, de Smedt E. Sur les formes familiales précoces de la maladie d'Alzheimer. *M Schr Psychiat Neurol* 1940; **102**: 249-301.

- 25 Arnold SE, Hyman BT, Flory J, Damasio AR, Van Hoesen GW. The topographical and neuroanatomical distribution of neurofibrillary tangles and neuritic plaques in the cerebral cortex of patients with Alzheimer's disease. *Cereb Cortex* 1991; **1**: 103-116.
- 26 Gravina SA, Ho L, Eckman CB *et al*: Amyloid β protein ($A\beta$) in Alzheimer's disease brain. Biochemical and immunocytochemical analysis with antibodies specific for forms ending at $A\beta$ 40 or $A\beta$ 42(43). *J Biol Chem* 1995; **270**: 7013-7016.
- 27 Citron M, Westaway D, Xia W *et al*: Mutant presenilins of Alzheimer's disease increase production of 42-residue amyloid β -protein in both transfected cells and transgenic mice. *Nat Med* 1997; **3**: 67-72.
- 28 Palop JJ, Mucke L. Epilepsy and cognitive impairments in Alzheimer disease. *Arch Neurol* 2009; **66**: 435-440.
- 29 Palop JJ, Chin J, Roberson ED *et al*: Aberrant excitatory neuronal activity and compensatory remodeling of inhibitory hippocampal circuits in mouse models of Alzheimer's disease. *Neuron* 2007; **55**: 697-711.

Titles and legends to figures

Figure 1. Pedigree of the EOAD family with a *PSEN1* I143T mutation. Filled symbols indicate affected individuals and symbols with a diagonal line indicate deceased individuals. Age at onset and age at death are shown below the symbols in years. The proband is indicated with an arrow. Healthy family members have been excluded. Information about the diagnoses for case III:2 and case III:1 were obtained by our own clinical examinations and neuropathological examinations. For the 1st and 2nd generation the information about the clinical symptoms, signs and clinical diagnoses were obtained by the medical records. We also re-examined autopsy material from case II:2.

Figure 2. Quantification of A β species in plaque cores and SDS-insoluble preparations from frontal-, parietal-, temporal-, and occipital cortex, anterior hippocampus and cerebellum of two carriers of *PSEN1* mutation. (A) Plaque cores from six brain regions of two *PSEN1* I143T mutation-carriers were cleaved with CNBr to generate C-terminal A β fragments and the samples were analyzed by HPLC-MS/MS. Standard curves were used for quantification. Left y-axis represents A β 42, and right y-axis represents A β 43. (B) SDS-insoluble material from six brain regions of two *PSEN1* cases was cleaved with CNBr to produce C-terminal A β fragments. The samples were analyzed by HPLC-MS/MS, and standard curves were used for quantification. (FR=Frontal cortex, PARIET=Parietal cortex, TEMP=Temporal cortex, OCC=Occipital cortex, HIPPOC=Hippocampus, CEREB=Cerebellum).

Figure 3. Immunohistochemistry. Immunostaining of amyloid in plaques and vessels in occipital cortex (A, B, C, D, E, F, G, H, I) and cerebellum (J, K, L, M, N, O) from case III:2 and case III:1. In each case, three consecutive sections were stained with C-terminal antibodies (from left to right) A β x-40, A β x-42 and A β x-43. Scale bar for figure A-F and J-O corresponds to 100 μ M. Scale bar for figure G-I corresponds to 20 μ M.

Figure 4. Secreted and cellular A β 40 and A β 42 in cultured fibroblasts. (A) Secreted and (B) cellular A β 40-and A β 42-levels from cultured fibroblasts measured by ELISA in a *PSEN1* I143T mutation-carrier, three healthy controls and an *APP*^{SwE} mutation-carrier.

Supplementary Figure 1. Standard curves used for quantifications. Standard curves were created by injecting 1 μ L of 500, 200, 50 or 20 fmoles of A β 36-40 and A β 36-42, and 25, 10, 2.5 or 1 fmoles of A β 36-43. Standard curves for quantification of (S2A) A β 36-40, (S2B) A β 36-42, and (S2C) A β 36-43.

Supplementary text 1.

A detailed description of the symptoms, clinical course and treatment of the family members.

Supplementary text 2.

A detailed neuropathological description of cases II:2, III:2 and III:1.

Table legend

Supplementary table 1. Characteristics of cases with EOAD in the Swedish family.

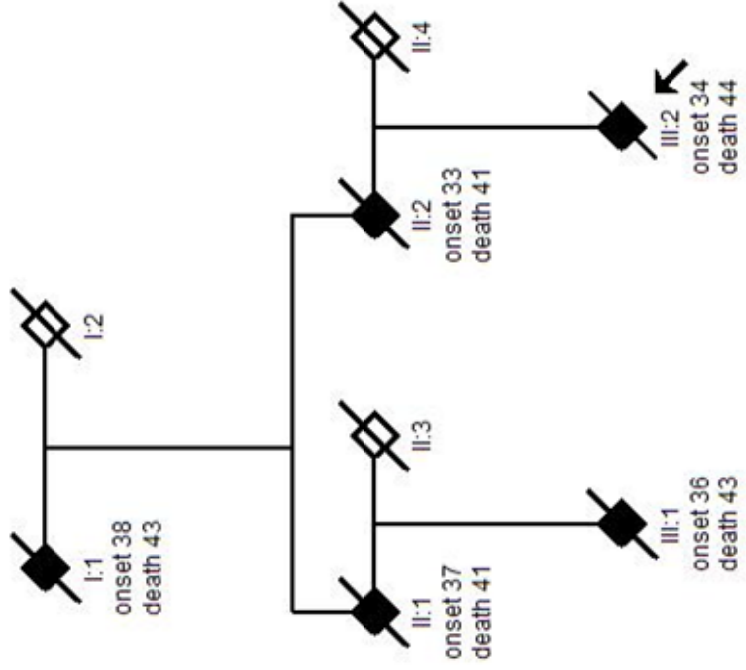

Figure 2A.

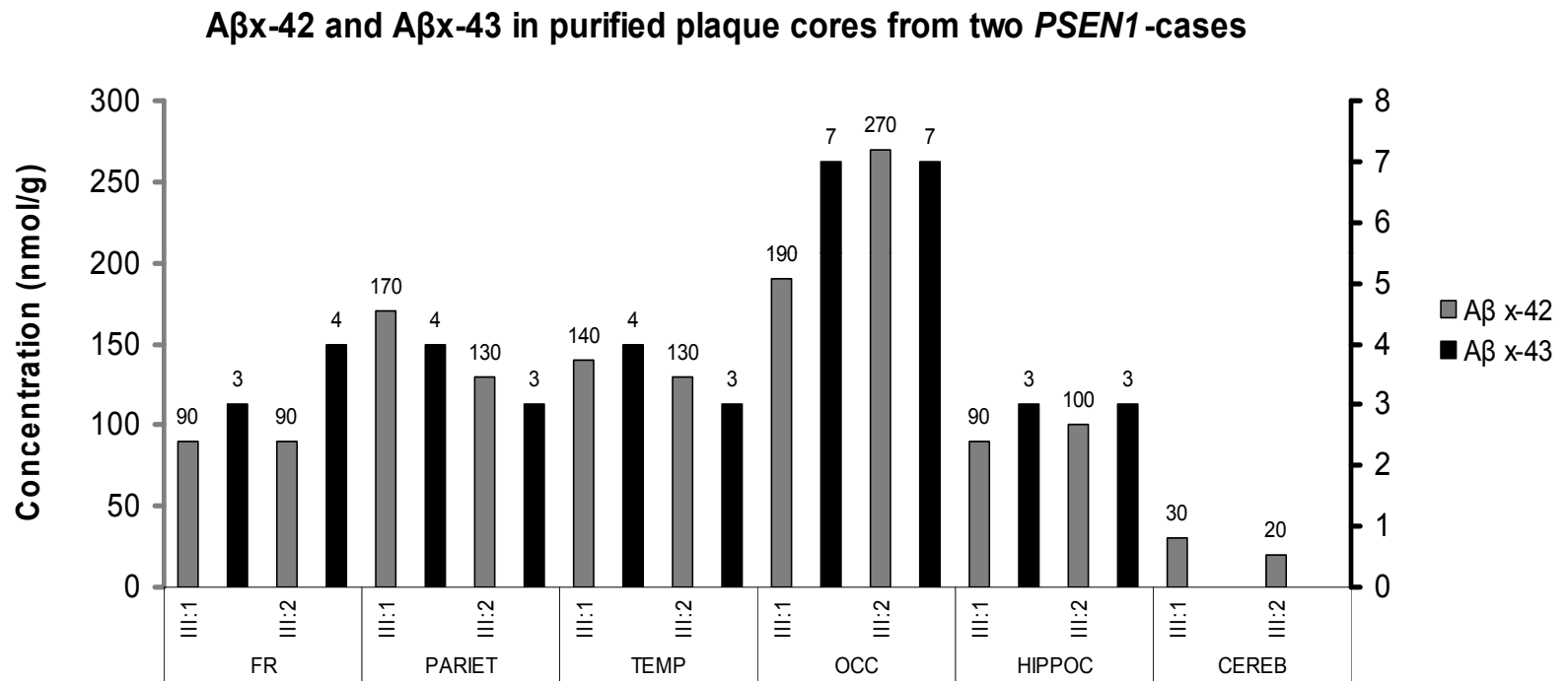

Figure 2B.

A β C-terminal variants in SDS preparations

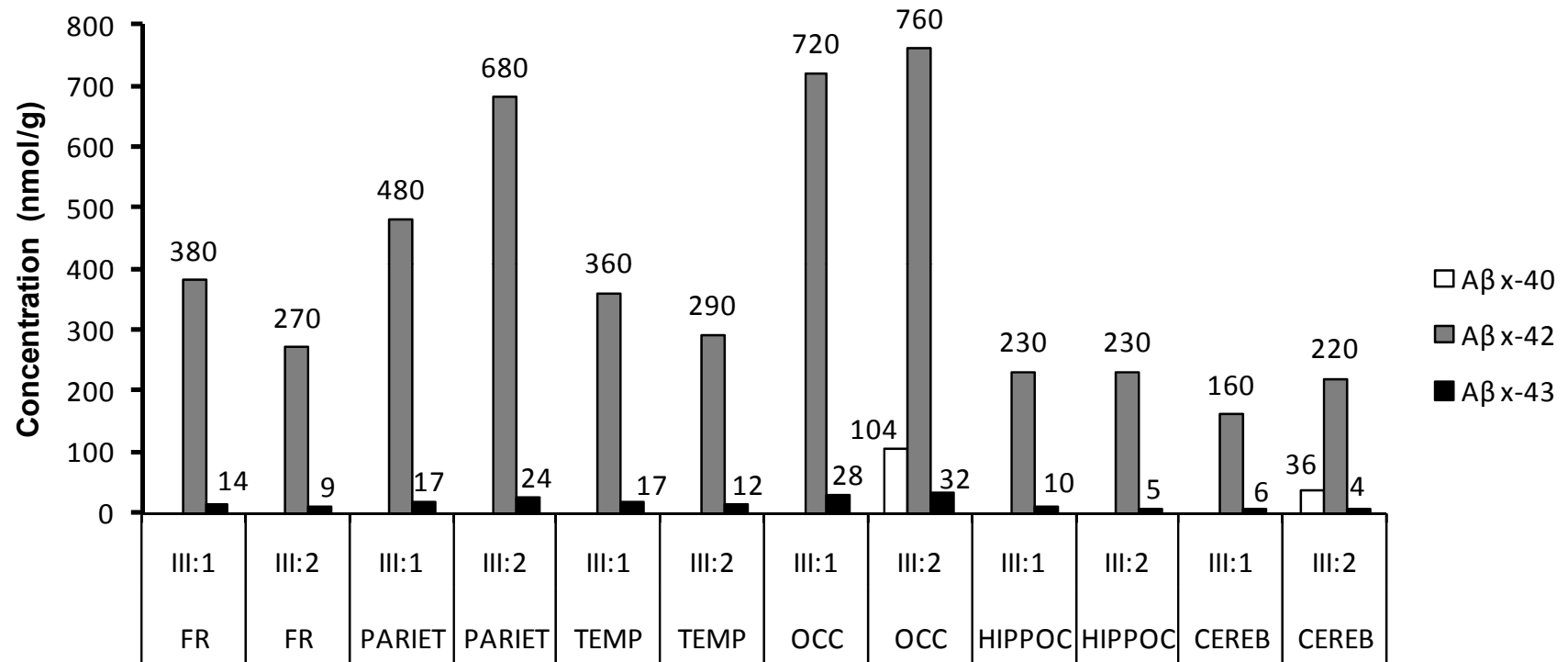
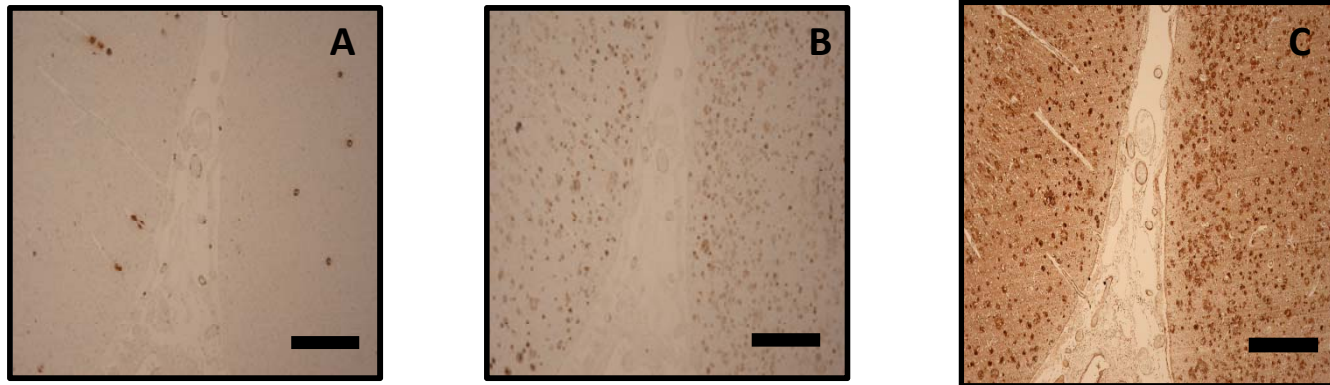

Figure 3.

Occipital cortex from case III:2, Scale bar = 100 μ m



Occipital cortex from case III:1, Scale bar = 100 μ m

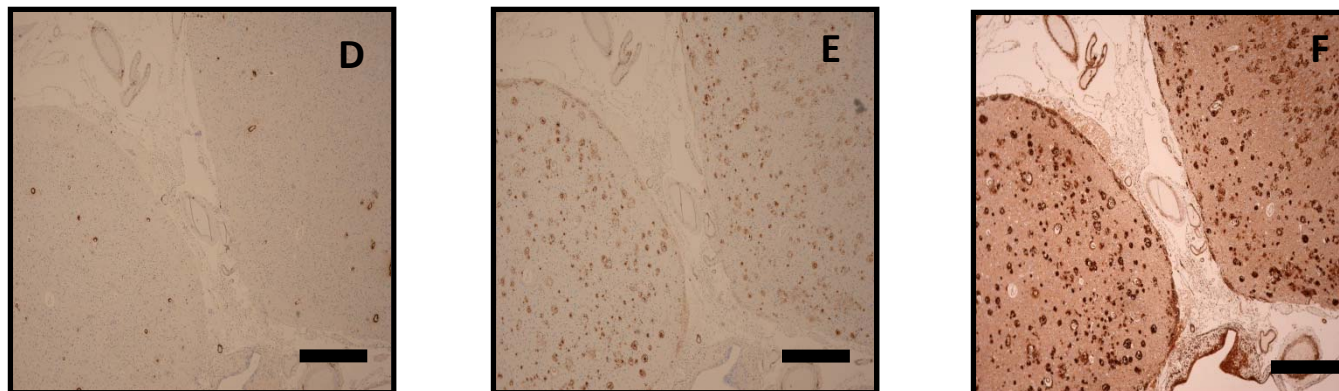

Figure 3.

Occipital cortex from case III:1, Scale bar = 20 μ m

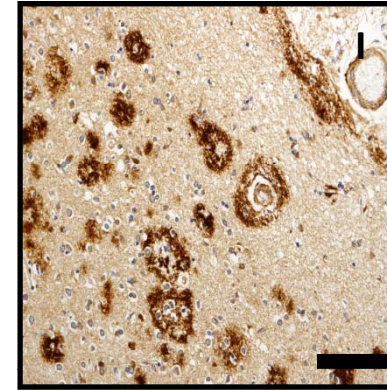
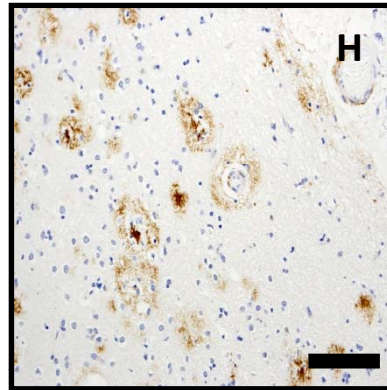
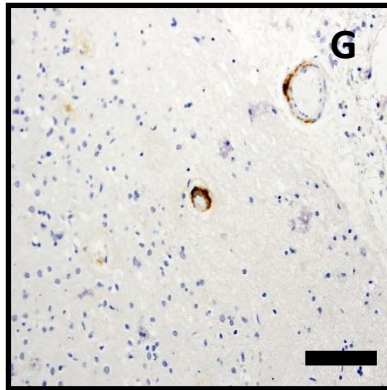
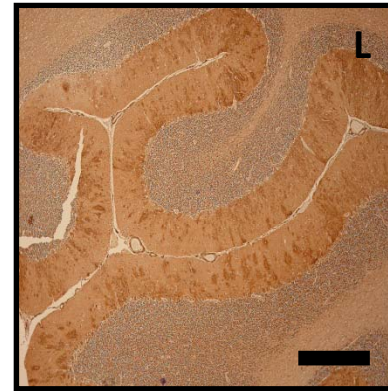
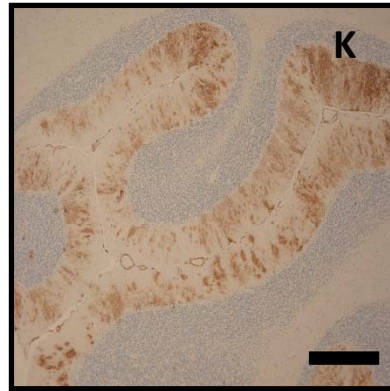
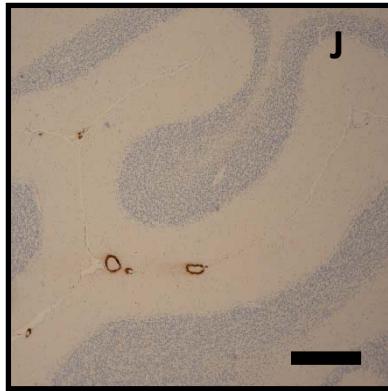

Figure 3.

Cerebellum from case III:2, Scale bar = 100 μ M



Cerebellum from case III:1, Scale bar = 100 μ M

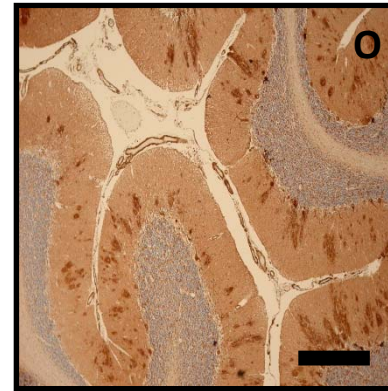
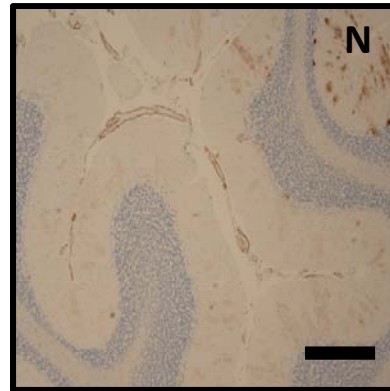
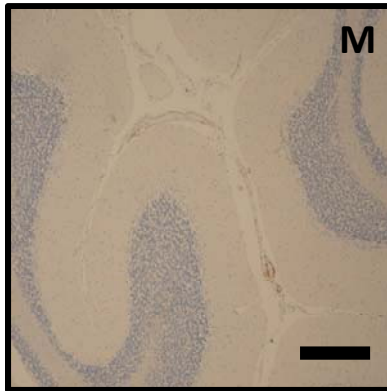

Figure 4A.

Secreted A β 40 and A β 42

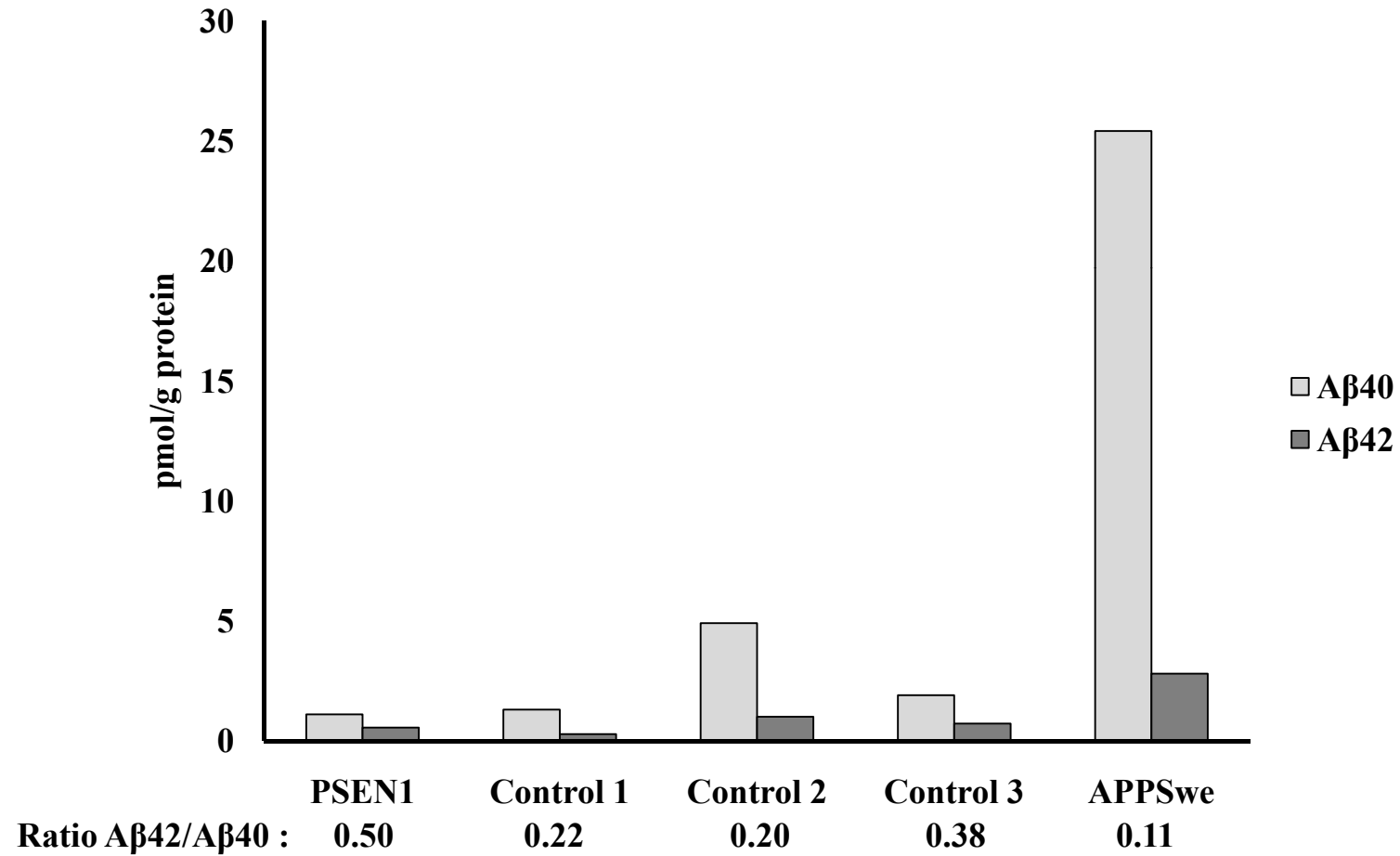

Figure 4B.

Cellular A β 40 and A β 42

