



HAL
open science

The human polycystin-2 protein represents an integral membrane protein with 6 membrane-spanning domains and intracellular NH₂- and COOH-termini

Helen Hoffmeister, Anna Rachel Gallagher, Anne Rascle, Ralph Witzgall

► **To cite this version:**

Helen Hoffmeister, Anna Rachel Gallagher, Anne Rascle, Ralph Witzgall. The human polycystin-2 protein represents an integral membrane protein with 6 membrane-spanning domains and intracellular NH₂- and COOH-termini. *Biochemical Journal*, 2010, 433 (2), pp.285-294. 10.1042/BJ20101141 . hal-00549897

HAL Id: hal-00549897

<https://hal.science/hal-00549897>

Submitted on 23 Dec 2010

HAL is a multi-disciplinary open access archive for the deposit and dissemination of scientific research documents, whether they are published or not. The documents may come from teaching and research institutions in France or abroad, or from public or private research centers.

L'archive ouverte pluridisciplinaire **HAL**, est destinée au dépôt et à la diffusion de documents scientifiques de niveau recherche, publiés ou non, émanant des établissements d'enseignement et de recherche français ou étrangers, des laboratoires publics ou privés.

The human polycystin-2 protein represents an integral membrane protein with 6 membrane-spanning domains and intracellular NH₂- and COOH-termini

Helen Hoffmeister¹, Anna-Rachel Gallagher², Anne Rasclé³,
Ralph Witzgall

Institute for Molecular and Cellular Anatomy, University of Regensburg, 93053 Regensburg, Germany

Corresponding author: Ralph Witzgall
University of Regensburg
Institute for Molecular and Cellular Anatomy
Universitätsstr. 31
93053 Regensburg
Germany
Tel: +49-(0)941-943-2821
Fax: +49-(0)941-943-2868
Email: ralph.witzgall@vkl.uni-regensburg.de

¹Present address: Institute of Biochemistry III, University of Regensburg, 93053 Regensburg, Germany

²Present address: Section of Nephrology, Yale University School of Medicine, New Haven, CT 06520, USA

³Present address: Institute of Immunology, University of Regensburg, 93053 Regensburg, Germany

Running head title: Membrane topology of polycystin-2

Keywords: Polycystin-2, TRPP2, membrane topology

Abstract

PKD2 is one of the two genes mutated in autosomal-dominant polycystic kidney disease (ADPKD). The protein product of *PKD2*, polycystin-2, functions as a non-selective cation channel in the endoplasmic reticulum and possibly at the plasma membrane. Hydrophobicity plots and its assignment to the TRP family of cation channels suggest that polycystin-2 contains 6 transmembrane domains and that both the NH₂- and COOH-termini extend into the cytoplasm. However, no experimental evidence for this model has been provided so far. To determine the orientation of the different loops of polycystin-2, we truncated polycystin-2 within the predicted loops 1 to 5 and tagged the constructs at the COOH-terminus with a HA-epitope. After transient expression and selective membrane permeabilization, immunofluorescence staining for the HA epitope revealed that loops 1, 3 and 5 extend into the lumen of the endoplasmic reticulum or the extracellular space, while loops 2 and 4 extend into the cytoplasm. This approach also confirmed the cytoplasmic orientation of the NH₂- and COOH-termini of polycystin-2. In accordance with the immunofluorescence data, protease protection assays from microsomal preparations yielded protected fragments when polycystin-2 was truncated in loops 1, 3 and 5 while no protected fragments could be detected when polycystin-2 was truncated in loops 2 and 4. Our data therefore provide the first experimental evidence for the topological orientation of polycystin-2.

Introduction

At a prevalence of at least 1:1,000, autosomal-dominant polycystic kidney disease is one of the most common inherited human diseases [1]. The main symptom of autosomal-dominant polycystic kidney disease is cyst formation within the kidney parenchyma but additional symptoms such as liver and pancreatic cysts, heart valve defects and aneurysms are common. 85% of the patients carry mutations in the *PKD1* gene and the remaining 15% suffer from mutations in the *PKD2* gene [2-5]. The protein encoded by *PKD1*, polycystin-1, is a transmembrane protein encompassing 4,302 amino acids [6-8], 11 transmembrane domains, an extracellular NH₂-terminus and a cytoplasmic COOH-terminus [9]. Polycystin-2, the protein product of the *PKD2* gene, is an integral membrane protein of 968 amino acids length with a predicted molecular weight of 110 kDa [10, 11]. It functions as a non-selective channel for mono- and divalent cations, and its activity is regulated by Ca²⁺ ions [12], probably through an EF-hand domain within the COOH-terminal domain [13, 14]. The subcellular location of polycystin-2 is discussed controversially. Beside its location in the endoplasmic reticulum, attributed to a 34-amino acid cluster in the COOH-terminus [10], polycystin-2 may also be present at the plasma membrane [15]. It is generally accepted, however, that polycystin-2 is integrated in the plasma membrane of the primary cilium [16, 17]. This pathway is regulated by a trafficking motif located within the first 15 amino acids of the protein [18].

The close homology of polycystin-2 to the TRP family of cation channels suggests that polycystin-2 consists of six transmembrane domains with both the NH₂- and COOH-terminus extending into the cytoplasm. In the absence of crystallography data for this membrane protein and in order to gain structural information which might help to better understand its function, we determined the topology of polycystin-2 by molecular and biochemical approaches.

Materials and methods

Expression plasmids and transfections

The full-length human PKD2 cDNA (a kind gift from Stefan Somlo, Yale University, New Haven) was subcloned into the eukaryotic expression vector pcDNA3 (Invitrogen). Various expression constructs were generated which coded for polycystin-2 proteins of 460, 493, 547, 577, 582 and 625 amino acids in length, respectively. In most cases a HA-epitope was fused to the COOH-terminus of the proteins (Table 1).

COS-7 cells were maintained in Dulbecco's modified Eagle's medium supplemented with 10% fetal calf serum. They were transiently transfected at a confluency of 70-80% with 15 µg DNA per 60-mm dish using the DEAE-dextran protocol [19].

Microsomal preparations

All manipulations were carried out at 4°C. Five 100-mm dishes with COS-7 cells were transiently transfected with the respective expression plasmids. 48 hours later the cells were washed 3 times with 1x PBS, scraped off the dishes and pelleted. The cell pellet was resuspended in buffer A (10 mM Hepes-KOH pH 7.4, 10 mM KCl, 1.5 mM MgCl₂, 5 mM Na-EDTA, 5 mM EGTA, 250 mM Sucrose), incubated for 15 minutes and then homogenized with 20 strokes in a Dounce homogenizer. Nuclei and intact cells were removed by centrifuging for 30 minutes at 1,000 g. The supernatant was cleaned once more by centrifuging for 15 minutes at 1,000 g before membrane vesicles were collected by centrifuging for 30 minutes at 55,000 rpm. This microsomal fraction was finally resuspended in buffer B (10 mM Hepes-KOH pH 7.4, 10 mM KCl, 1.5 mM MgCl₂, 5 mM Na-EDTA, 5 mM EGTA, 250 mM Sucrose, 100 mM NaCl).

Protease protection assay

The microsomal preparation (in buffer B) was divided into two halves and centrifuged again at 55,000 rpm for 30 minutes. Subsequently one pellet was resuspended in buffer B containing 1% Triton X-100 and the other pellet in buffer B only. The resuspended vesicles were incubated for 1 hour at 4°C in the presence or absence of 1 mg/ml of proteinase K [except in the case of polycystin-2 (loop 3), HA when 4 mg/ml of proteinase K was used]. A control reaction in buffer B without Triton X-100 was performed in parallel. Reactions were stopped by incubating in 5 mM PMSF for 20 minutes at RT, and analyzed by immunoprecipitation, as described below.

PNGase F assay

Proteinase K-treated and untreated microsomal preparations of transiently transfected COS-7 cells synthesizing polycystin-2 (loop 1), HA were denatured for 10 minutes at 100°C in 1x denaturing buffer (New England Biolabs) as recommended in the manufacturer's instructions. Then the samples were supplemented with (final concentration) 1% NP-40 and 1x G7 buffer (New England Biolabs) and incubated with 8.3 U/µl of PNGase F (New England Biolabs) for 90 minutes at 37°C, control samples were incubated without PNGase F. Finally the deglycosylated proteins were subjected to immunoprecipitation as described below.

Immunoprecipitation

For immunoprecipitations non-permeabilized samples from the protease protection assays were first permeabilized for 30 minutes on ice by adding 1% Triton X-100 (final concentration). The reactions were performed in 600 μ l buffer B containing 20 μ l protein A sepharose beads (GE Healthcare) coupled with the monoclonal anti-HA-epitope antibody 12CA5 (500 μ l hybridoma supernatant per 20 μ l beads). Immunoprecipitations were performed for 4 hours at 4°C on a rotating wheel, then the beads were briefly spun down, washed 4 times in buffer B and resuspended in an equal volume of 2x sample buffer. Supernatants obtained after the immunoprecipitation were kept for later Western blot analysis.

Western blot

Total cell lysates were prepared 48 hours after the transient transfection of COS-7 cells. The cells were washed 3 times with 1x PBS, scraped off the petri dishes and centrifuged for 15 minutes at 4,000 rpm and 4°C. After the cell pellet was lysed in 1x PBS, 1% Triton X-100, 10 μ g/ml of aprotinin, 10 μ g/ml of leupeptin, 0.5 mM PMSF, the protein concentration was determined using a Bradford assay. Thirty μ g of total protein or immunoprecipitated protein were subjected to denaturing polyacrylamide gel electrophoresis before being transferred onto a PVDF-membrane (Millipore). The membrane was incubated with one of the following primary antibodies: the rat monoclonal anti-HA-epitope antibody 3F10 (Roche Diagnostics; diluted 1:4,000), a rabbit polyclonal anti-calreticulin antibody (Stressgen; diluted 1:2,000), and a rabbit polyclonal anti-actin antibody (Sigma; diluted 1:2,500). The following secondary antibodies were used: horseradish peroxidase-conjugated anti-rabbit IgG (Sigma; diluted 1:20,000) and horseradish peroxidase-conjugated anti-rat IgG (Dianova; diluted 1:20,000).

Immunofluorescence

For immunofluorescence labelling, cells were fixed for 1 hour at room temperature with Bouin's solution (0.1 M NaP_i pH 7.4, 15% saturated picric acid, 2% formaldehyde), washed 3 times with 1x PBS, and permeabilized for 15 minutes with 0.25% Triton X-100 at room temperature or with 5 μ g/ml of digitonin at 4°C. Fixation of non-permeabilized cells was performed for 1 hour at room temperature with 1x PBS, 4% paraformaldehyde, then cells were washed 3 times in 1x PBS, and blocked with 1x PBS, 2% BSA for 1 hour at room temperature. The fixed cells were incubated with the primary antibodies (diluted in 1x PBS, 2% BSA) for 2 hours at room temperature. After the cells were washed once with high-salt 1x PBS (500 mM NaCl total concentration) and twice with 1x PBS, they were incubated with the secondary antibodies (diluted in 1x PBS, 2% BSA) for 1 hour at room temperature. The cells were washed again with high-salt and regular 1x PBS before the nuclei were stained for 1 minute at room temperature with 10 μ g/ml of Hoechst 33258. Finally the cells were washed 3 times with 1x PBS and mounted in 1x PBS, 40% glycerol. Images were acquired using a Zeiss LSM 710 confocal laser scanning microscope and processed with Adobe Photoshop. The following primary antibodies were used: a mouse monoclonal anti-acetylated tubulin antibody (Sigma; diluted 1:200); a rabbit polyclonal antiserum raised against the peptide NH₂-CSIPQDLRDEIKE-COOH (amino acids 331-343 of human polycystin-2) (diluted 1:100), the mouse monoclonal anti-HA-epitope antibody 12CA5 (hybridoma supernatant; diluted 1:30), a polyclonal anti-HA-epitope antibody (Sigma; diluted 1:100), the mouse monoclonal anti-CD8 antibody OKT8 (hybridoma supernatant; diluted 1:30), a mouse monoclonal anti-calnexin antibody (BD Biosciences; diluted 1:30), the rabbit polyclonal anti-polycystin-2 antiserum YCB9 directed against amino acids 103-203 of human polycystin-2 (diluted 1:4,000). The following secondary antibodies were used: FITC-conjugated anti-mouse IgG (ICN

Biomedicals; diluted 1:200), Cy3-conjugated anti-mouse IgG (Dianova; diluted 1:300), Cy3-conjugated anti-rabbit IgG (Dianova; diluted 1:400).

Accepted Manuscript

THIS IS NOT THE VERSION OF RECORD - see doi:10.1042/BJ20101141

Results

Determining the topology of polycystin-2 by immunofluorescence

According to two hydrophobicity plot-based structural predictions [[11] and SwissProt database (accession number Q13563)], the polycystin-2 protein contains 6 transmembrane domains, with the NH₂-terminus and the COOH-terminus extending into the cytoplasm (Fig. 1). While both models show minor differences with respect to the position of transmembrane domains 1, 2, 3, 5 and 6, they diverge markedly on the first and last amino acid positions of the fourth transmembrane helix (Fig. 1). To elucidate the topology of polycystin-2 experimentally and to better characterize the position of its transmembrane domains and loops, we examined full-length and COOH-terminal truncation mutants of polycystin-2 tagged at the COOH-terminus with a HA-epitope (Fig. 2). Upon transient transfection into COS-7 cells, the cellular location (plasma membrane, endoplasmic reticulum) of the HA-epitope-tagged proteins was determined with an anti-HA-epitope antibody in the presence of selective permeabilization agents such as digitonin and Triton X-100. Digitonin allows the specific permeabilization of the plasma membrane, while Triton X-100 permeabilizes all cellular membranes [20]. The specificity of the selective permeabilization treatments was verified by immunofluorescence using an antibody against a cytoplasmic protein (acetylated tubulin) and an antibody against a protein located in the lumen of the endoplasmic reticulum (calnexin).

To first verify whether the NH₂- and COOH-termini of polycystin-2 extend into the cytoplasm as postulated by structural predictions, COS-7 cells were transiently transfected with a construct coding for the full-length polycystin-2 protein fused to a COOH-terminal HA-epitope (Fig. 2). Forty-eight hours after transfection cells were fixed and incubated either with a monoclonal anti-HA-epitope antibody or with a polyclonal antibody directed against amino acids 103 to 203 of polycystin-2 (Fig. 3). In either case the full-length protein was already detectable in digitonin-permeabilized cells (Fig. 3) which confirms the predicted cytoplasmic location of the NH₂- and COOH-termini of full-length polycystin-2. Our experimental approach was validated by control stainings for acetylated tubulin and calnexin. A tubulin signal was detected in digitonin- and Triton X-100-permeabilized cells but not in non-permeabilized cells (Fig. 3) whereas calnexin was first visible after permeabilizing the cells with Triton X-100 (Fig. 3).

We next focused on elucidating the orientation of the 5 putative loops of polycystin-2 using the same indirect immunofluorescence approach. For that purpose, progressive COOH-terminal deletions of polycystin-2 were generated which ended within the predicted loops and which were tagged with a HA-epitope at the COOH-terminus (Fig. 2). All five truncated proteins could be detected by Western blot analysis (suppl. Fig. 1). Since these proteins lack the COOH-terminal retention signal for the endoplasmic reticulum they were expected to reach the plasma membrane, and (depending on the orientation of the respective loop) should be detectable in either non-permeabilized or digitonin-treated cells. Polycystin-2 mutant proteins truncated in loops 4 and 5 indeed reached the plasma membrane (Fig. 4) which was confirmed by double-immunofluorescence staining for the plasma membrane marker CD8 (suppl. Fig. 2). By contrast, polycystin-2 proteins truncated in loops 1, 2 and 3 did not reach the plasma membrane and were retained intracellularly which was evident by a cytoplasmic staining pattern upon either digitonin or Triton X-100 treatment (Fig. 4) similar to that observed for the full-length protein (Fig. 3). This intracellular location was confirmed by the absence of co-localization with the plasma membrane marker CD8 (suppl. Fig. 2 and data not

shown). These observations argue for the presence of a plasma membrane export signal between amino acids 547 and 582 (manuscript submitted).

In spite of the different locations of the truncated polycystin-2 proteins, selective permeabilization allowed us to determine the orientation of the respective loops by immunofluorescence. In COS-7 cells synthesizing the mutant truncated in loop 5, an immunofluorescence signal was already detected without permeabilization (Fig. 4) which argued that this loop extends into the extracellular space. Both the loop 4 mutant (which reaches the plasma membrane) and the loop 2 mutant (which is retained intracellularly) were first detected after digitonin treatment (Fig. 4). This result argued for a cytoplasmic orientation of both loops. Permeabilization of COS-7 cells with Triton X-100 finally allowed the detection of the polycystin-2 mutant proteins truncated in loop 1 and loop 3, respectively (Fig. 4), which demonstrates that both loops extend into the lumen of the endoplasmic reticulum. The orientation of loop 1 was also verified using an antibody directed against amino acids 331 to 341 (loop 1) (Fig. 5). A polycystin-2 mutant protein located in the plasma membrane was already detected with this antibody in non-permeabilized cells (Fig. 5), thus arguing that loop 1 extends into the extracellular space. A similar pattern was observed with this antibody upon synthesis of the same polycystin-2 fragment lacking the COOH-terminal HA-epitope (Fig. 5) which makes it unlikely that the HA-epitope influences the overall topology of the COOH-terminal deletion mutants. Our immunofluorescence data are therefore compatible with the model (1) that polycystin-2 contains six transmembrane domains, (2) that its NH₂- and COOH-termini extend into the cytoplasm, (3) that its loops 1, 3 and 5 extend into the lumen of the endoplasmic reticulum and the extracellular space, respectively, and (4) that its loops 2 and 4 extend into the cytoplasm.

Determining the topology of polycystin-2 using protease protection assays

To verify the immunofluorescence data, protease protection assays were performed on microsomal preparations of transiently transfected COS-7 cells producing the truncated polycystin-2 mutant proteins. Microsomes are membrane vesicles with cytoplasmic-side-out orientation [21]. Protease treatment of non-permeabilized microsomes will therefore exclusively digest protein domains which extend into the cytosol, while protein domains exposed to the microsomal lumen (lumen of the endoplasmic reticulum, extracellular space) are protected. Assuming that proteinase K cleaves polycystin-2 after amino acid 221 (within the NH₂-terminus, immediately preceding the first residue of the first transmembrane domain), amino acids 492 and 503 (within putative loop 2) and amino acids 571 and 598 (within putative loop 4), one would expect protected fragments with molecular weights of ~28.9 kDa, 6.6 to 8.0 kDa and 4.7 to 7.8 kDa, respectively, upon proteinase K digestion in the absence of detergent for the loop 1, loop 3 and loop 5 constructs (Fig. 6). Protease protection assays were performed with microsomes in the absence and presence of 1% Triton X-100 and in the absence and presence of proteinase K. Protected fragments were immunoprecipitated with the murine monoclonal anti-HA-epitope antibody 12CA5 and detected by Western blot with the rat monoclonal anti-HA-epitope antibody 3F10. The integrity of the microsomal preparations was controlled by Western blot analysis of the post-immunoprecipitation supernatants using an antibody directed against the luminal endoplasmic reticulum protein calreticulin. As predicted, calreticulin was only degraded by proteinase K when Triton X-100 was added to the microsomal fractions (Fig. 7a, lane 4). Proteinase K cleavage of non-permeabilized vesicles from cells producing polycystin-2 (loop 1), HA yielded a protected fragment (Fig. 7a, lane 2) and therefore corroborated the immunofluorescence data that loop 1 extended into the lumen of the endoplasmic reticulum. However, the observed molecular

weight of the protected fragment (~40 kDa) exceeded the expected size markedly. Since full-length polycystin-2 is known to be *N*-glycosylated [10, 22, 23], possibly at five predicted glycosylation sites within loop 1, we investigated whether the higher molecular weight of the protected fragment was due to glycosylation. Microsomal preparations of cells synthesizing polycystin-2 (loop 1), HA were incubated with the enzyme PNGase F which cleaves all *N*-glycosidic bonds. Upon PNGase F treatment, the polycystin-2 (loop 1), HA protein migrated with a markedly higher mobility (Fig. 7b, lane 2), thus confirming that loop 1 is glycosylated. PNGase F treatment of proteinase K-digested polycystin-2 (loop 1), HA generated a protected fragment of ~28 kDa (Fig. 7c, lane 2) which again is close to the predicted molecular weight of 28.9 kDa (Fig. 6). These data thus confirm that loop 1 of polycystin-2 is *N*-glycosylated and that it extends into the lumen of the endoplasmic reticulum. By inference the higher apparent molecular weight of polycystin-2 (loop 2), HA and (loop 3), HA proteins (suppl. Fig. 1, lanes 1-3) is probably due to glycosylation within loop 1.

Analogous protease protection assays were performed from microsomal preparations of COS-7 cells producing polycystin-2 (loop 3), HA and polycystin-2 (loop 5), HA and revealed protected fragments of the expected size (Fig. 6) of ~8.0 kDa (Fig. 10a, lanes 3 and 4) and ~5 kDa (Fig. 8b, lane 2), respectively. This confirmed that loops 3 and 5 also extend into the microsomal lumen, in agreement with the immunofluorescence data. In the case of polycystin-2 (loop 3), HA, a 4-fold higher concentration of proteinase K was necessary to achieve complete digestion. The resulting protected fragment was slightly smaller than expected (Fig. 8a, lane 4) which could not be explained by the penetration of proteinase K into damaged microsomes because calreticulin levels remained unaffected (Fig. 8a, lower panel, compare lanes 3 and 4). The fact that protected fragments of the expected size were detected demonstrates that the predicted cleavage sites (Fig. 6) between amino acids 492 to 503 and 571 to 598, respectively, were accessible to proteinase K. This in turn suggests a cytoplasmic orientation of loops 2 and 4. Indeed no protected fragment could be detected with microsomes of COS-7 cells synthesizing polycystin-2 (loop 2), HA- and (loop 4), HA (data not shown). Taken together, these protease protection assays confirm our immunofluorescence data and strongly support a topology model for polycystin-2 in which loops 1, 3 and 5 extend into the lumen of the endoplasmic reticulum (or the extracellular space) whereas loops 2 and 4 extend into the cytosol (Fig. 9). Furthermore, our immunofluorescence data confirm the cytoplasmic orientation of the NH₂- and COOH-termini of polycystin-2 (Fig. 9).

Accepted Article

Discussion

PKD2 is one of the two genes mutated in patients with autosomal-dominant polycystic kidney disease. Despite extensive efforts it remains unclear how mutations lead to polycystic kidney disease. *PKD2* encodes the non-selective cation channel polycystin-2, a member of the TRP family of cation channels. Since structural information provides clues on the function of polycystin-2 and will help to better characterize disease-associated mutations, we here elucidate the topology of this calcium channel.

Topology studies of integral membrane proteins are ideally carried out with the full-length protein, e.g. by inserting specific immunological epitopes or *N*-glycosylation sites into the protein. The location of the inserted domains is subsequently determined by the access of the epitope to the respective antibody in non-permeabilized and permeabilized cells and by the access of the novel glycosylation sites to the glycosylation machinery which is exclusively located in the lumen of the endoplasmic reticulum and Golgi apparatus. Our initial attempts to elucidate the topology of polycystin-2 by using the latter approach failed because polycystin-2 became increasingly unstable the more of the endogenous *N*-glycosylation sites were removed, a typical phenomenon attributed to the loss of structural integrity of the protein [24]. In light of the very limited structural data for polycystin-2 we chose the strategy to generate progressively shorter polycystin-2 proteins with a HA-epitope at their very COOH-terminus. One of the possible drawbacks of our approach could be an altered topology of the truncated proteins. This objection cannot be held against our topology study because the cytoplasmic orientation of the NH₂-terminus was demonstrated both by immunofluorescence in the context of the full-length protein and by the identification of a protected fragment for polycystin-2 (loop 1), HA in the proteinase K protection assay. The cytoplasmic location of the NH₂-terminus confirms published data obtained with the pathogenic polycystin-2 mutant protein R742X [10, 25]. Finally the observation that loop 1 was detected in the lumen of the endoplasmic reticulum or extending into the extracellular space in polycystin-2 constructs of different lengths and independently of the presence of a COOH-terminal HA-epitope indicates that neither the COOH-terminal deletions nor the HA-epitope altered the overall topology of polycystin-2.

Our model that the NH₂-terminus, the COOH-terminus and loops 2 and 4 of polycystin-2 extend into the cytoplasm whereas loops 1, 3 and 5 are located in the lumen of the endoplasmic reticulum is in agreement with two hydrophobicity plot-based structural predictions of polycystin-2 [[11] and SwissProt database (accession number Q13563)]. As a matter of fact our experimental data solve a discrepancy between both predictions regarding the exact position of transmembrane domain 4 (Fig. 1). We show that the constructs truncated at amino acid positions 573 to 577 were accessible to the anti-HA-epitope antibody upon digitonin treatment (data not shown) which indicates that this part of loop 4 extends into the cytoplasm and cannot be part of the transmembrane domain 4 as suggested [11]. Our experimental data rather support the SwissProt database model which proposes that transmembrane domain 4 ends at amino acid 571.

Our data also confirm the predicted cytoplasmic location of the COOH-terminus of full-length polycystin-2. A cytoplasmic orientation of the COOH-terminus is in agreement with the fact that this portion of polycystin-2 interacts with many cytosolic proteins [26]. A similar argument holds true for the cytoplasmic orientation of the NH₂-terminus of polycystin-2 which interacts with cytoplasmic proteins like α -actinin and KIF3B [27, 28]. The following additional findings support the orientation of the NH₂-and COOH-terminus in the cytoplasm:

(1) phosphorylation sites have been identified in the NH₂-terminus [29] and COOH-terminus of polycystin-2 [22, 25], (2) a ciliary trafficking motif has been identified in the NH₂-terminus [18] and (3) a retention signal for the endoplasmic reticulum has been identified in the COOH-terminus of polycystin-2 [10]. The proposed orientation of loop domain 5 also fits with previous data. Addition of an antibody directed against loop 5 of murine polycystin-2 abrogates the flow-induced calcium response of embryonic kidney cells which is attributed to a functional plasma membrane complex of polycystin-1 and polycystin-2 [30].

In summary, our study provides the first experimental evidence for the topology of polycystin-2. It constitutes another step toward a better characterization of the function of polycystin-2 and will improve our understanding of mutations in *PKD2*.

Acknowledgements

Uwe de Vries was instrumental in taking pictures at the confocal laser scanning microscope. We thank Elisabeth Besl and Larissa Osten for expert technical assistance. We are grateful for the kind gift of the YCB9 antiserum from Yiqiang Cai and Stefan Somlo, and for the generation of the anti-polycystin-2 peptide antiserum by Bernhard Dobberstein. Antje Zenker and Ton Maurer skillfully arranged the figures. This work was supported by the German Research Council through SFB 699.

10	20	30	40	50	60	70	
<u>MVNSSRVQPQ</u> QPGDAKRP	PPA	PRAPDPGR	LM	AGCAAVGASL	AAPGGLCEQR	GLEIEMQRIR	QAAARDPPAG
80	90	100	110	120	130	140	
AAASPPPLS	SCSRQAWSRD	NPGFEAE	EEEE	EEVEGEEGGM	VVEMDVEWRP	GSRRSAASSA	VSSVGARSRG
150	160	170	180	190	200	210	
LGGYHGAGHP	SGRRRRREDQ	GPPCPSVGG	GDPLHRHLPL	EGQPPRVAWA	ERLVRGLRGL	WGTRLMEESS	
220	230	240	250	260	270	280	
TNREKYLKSV	<u>LRELVTYLLF</u>	<u>LIVLCILTYG</u>	<u>MMSSNVYYT</u>	RMMSQLFLDT	PVSKTEKTNF	KTLSMEDFW	
290	300	310	320	330	340	350	
KFTEGSLLDG	LYWKMQPSNQ	TEADNRSFIF	YENLLLGVPR	IRQLRVRNGS	CSIPQDLRDE	IKECYDVYSV	
360	370	380	390	400	410	420	
SSEDRAFGP	RNGTAWIYTS	EKDLNGSSHW	GIIATYSGAG	YYLDSRTRE	ETAAQVASLK	KNVWLDGRTR	
430	440	450	460	470	480	490	
ATFIDFSVYN	ANINLFCVVR	LLVEFPATGG	VIPSWQFQPL	KLIRYVTTFD	<u>FFLAACEIIF</u>	<u>CFFIFYVVE</u>	
500	510	520	530	540	550	560	
EILEIRIHKL	<u>HYFRSEWNCL</u>	<u>DVVIWVLSV</u>	<u>AIGINIYRTS</u>	NVEVLLQFLE	DQNTFPNFEH	<u>LAYWQIQFNN</u>	
570	580	590	600	610	620	630	
<u>IAAVTVFFVW</u>	<u>IKLKFIFNFN</u>	RTMSQLSTTM	SRCAKDLFGF	<u>AIMFFIIFLA</u>	<u>YAQLAYLVFG</u>	TQVDDFSTFQ	
640	650	660	670	680	690	700	
ECIFTQFRII	LGDINFAEIE	EANRVLGPIY	FTTFVFFMFF	<u>ILLNMFLATI</u>	NDTYSEVKSD	LAQQAEMEL	
710	720	730	740	750	760	770	
SDLIRKGYHK	ALVKLKLKKN	TVDDISESLR	QGGGKLNFE	LRQDLKGGKH	TDAEIEAIFT	KYDQDGDQEL	
780	790	800	810	820	830	840	
TEHEHQMRD	DLEKER <u>EDLD</u>	<u>LDHSSLPRPM</u>	<u>SSRSFPRSLD</u>	<u>DSEEDDEDS</u>	GHSSRRRSGI	SSGVSYEEFQ	
850	860	870	880	890	900	910	
VLVRRVDRME	HSIGSIVSKI	DAVIVKLEIM	ERAKLKRREV	LGRLLDGVAE	DERLGRDSEI	HREQMERLVR	
920	930	940	950	960			
EELERWESDD	AASQISHGLG	TPVGLNGQPR	PRSSRPSSSQ	STEGMEGAGG	NGSSNVHV		

Figure 1. Putative transmembrane domains in the human polycystin-2 protein (GenBank accession number NM_000288.1). The transmembrane domains suggested by a previous publication [11] are indicated by bars above the sequence and those predicted by SwissProt (accession number Q13563) by bars below the sequence. The ciliary targeting motif (amino acids 1-15) and the retention signal for the endoplasmic reticulum (amino acids 787-820) are boxed.

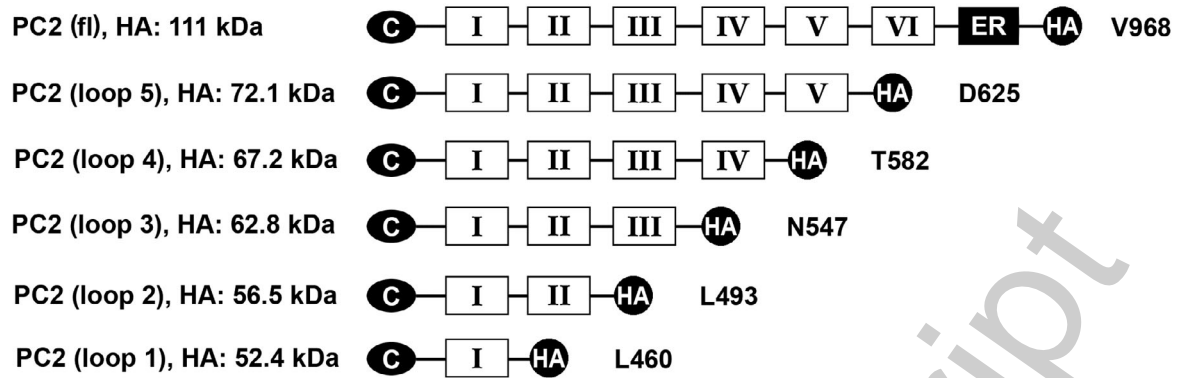

Figure 2. Constructs used for the topology study. PC2 (fl), HA encodes the full-length polycystin-2 protein, and the constructs named PC2 (loop 1-5), HA represent truncation mutants of human polycystin-2. The last amino acid of each construct is shown on the right, and the predicted molecular weight is shown on the left. The oval represents the NH₂-terminal ciliary targeting motif (C), open rectangles the putative transmembrane domains (numbered I-VI), the full rectangle the retention signal for the endoplasmic reticulum (ER) and the circle the HA-epitope (HA) which was attached to the very COOH-terminus of each construct. Not drawn to scale.

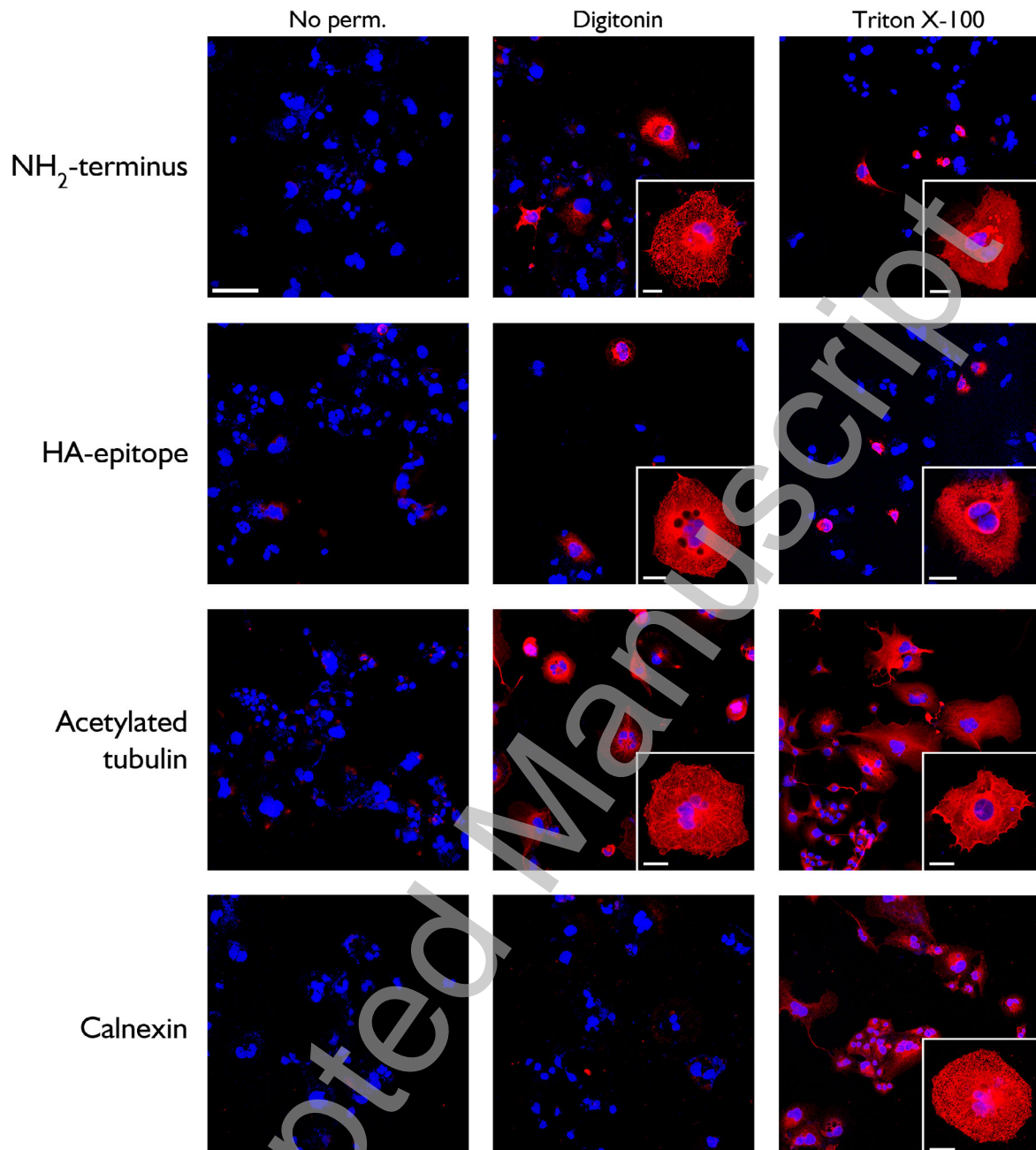

Figure 3. The NH₂- and COOH-termini of polycystin-2 extend into the cytoplasm. COS-7 cells were transiently transfected with an expression plasmid encoding full-length polycystin-2 tagged with a HA-epitope at the COOH-terminus. Non-permeabilized (No perm.), digitonin-treated and Triton X-100-treated cells were stained with an antibody directed against amino acids 103 to 203 (NH₂-terminus) of polycystin-2 and with an antibody against the HA-epitope. Both the NH₂- and the COOH-terminus were already visible after digitonin treatment thus demonstrating their cytoplasmic orientation. Control stainings against tubulin and calnexin confirmed that the plasma membrane was intact in non-permeabilized cells and that the membrane of the endoplasmic reticulum was still intact in the presence of digitonin. Nuclei were counterstained with the DNA-binding dye Hoechst 33258. Bars, 100 μ m in overviews and 25 μ m in insets.

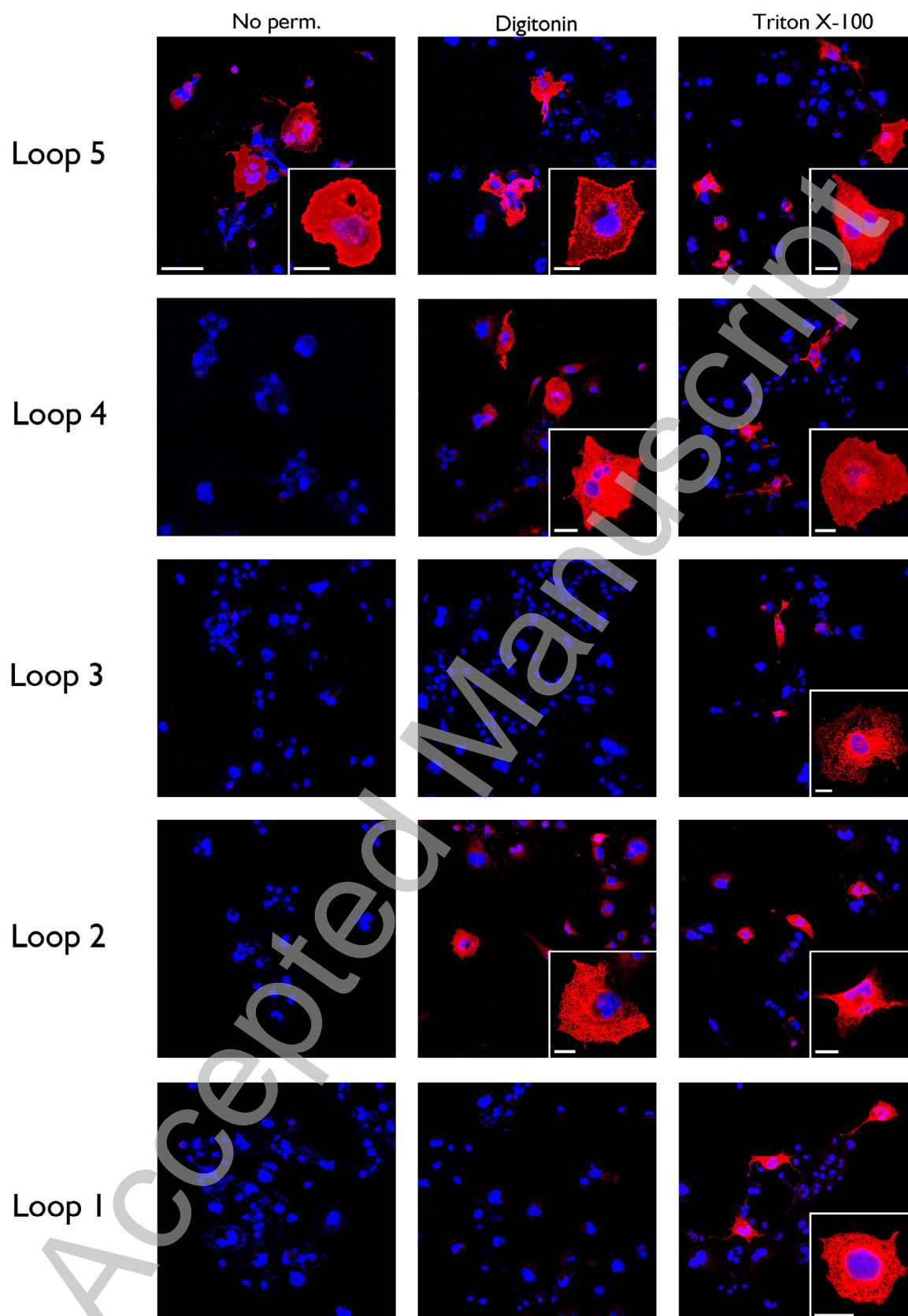

Figure 4. Topology determination of human polycystin-2 by selective permeabilization. Non-permeabilized (No perm.), digitonin-treated and Triton X-100-treated COS-7 cells transiently producing polycystin-2 (loop 1-5), HA were stained with an anti-HA-epitope antibody. Constructs truncated in loops 4 and 5 were transported to the plasma membrane while those truncated in loops 1, 2 and 3 were retained intracellularly. Loop 5 extends into the extracellular space, loops 4 and 2 extend into the cytoplasm, and loops 3 and 1 extend into the lumen of the endoplasmic reticulum. Nuclei were counterstained with the DNA-binding dye Hoechst 33258. Bars, 100 μm in overviews and 25 μm in insets.

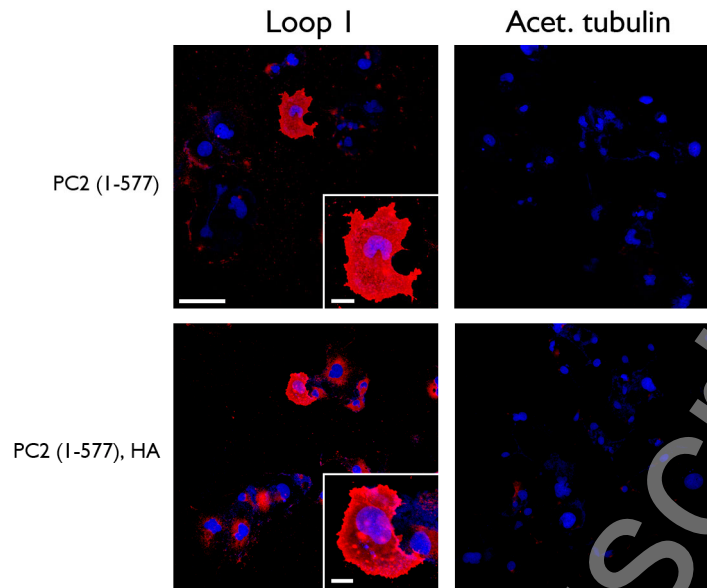

Figure 5. Immunofluorescence staining of non-tagged and HA-epitope-tagged human polycystin-2 truncated after amino acid 577. Non-permeabilized COS-7 cells transiently producing a 577-amino acid long polycystin-2 protein with and without a COOH-terminal HA-epitope were immunostained with an antibody directed against amino acids 331-343 of polycystin-2 (Loop 1). Regardless of the presence of the HA-epitope, both proteins are detectable at the plasma membrane of non-permeabilized cells which shows that loop 1 extends into the extracellular space and that the presence of the HA-epitope does not affect the topology of polycystin-2. An absent signal after staining for acetylated tubulin (Acet. tubulin) demonstrates the integrity of the plasma membrane. Nuclei were counterstained with the DNA-binding dye Hoechst 33258. Bars, 100 μ m in overviews and 25 μ m in insets.

a) Protected fragment of PC2 (loop 1), HA: 28.9 kDa

	*	I			
TNREKYLKSV	LREL	<u>VTYLLF</u>	LIVLCILTYG	MMSSNVYYT	RMMSQLFLDT
PVSKTEKTNF	KTLS	SMEDFW	KFTEGSLLDG	LYWKMQPSNO	TEADNRSFIF
YENLLLGVPR	IRQL	RVRNGS	CSIPQDLRDE	IKECYDVYSV	SSEDRAFPGP
RNGTAWIYTS	EKDL	NGSSHW	GIIATYSGAG	YYLDLSRTRE	ETAAQVASK
KNVWLDGRTR	ATFID	FSVYN	ANINLFCVVR	LLVEFPATGG	VIPSWQFQPL
SYPYDVPDYA	ID				

b) Protected fragment of PC2 (loop 3), HA: 6.6 to 8.0 kDa

II	*		*	III	
<u>FIFYVVEEI</u>	LEIRI	HKLHY	FRSF	<u>WNCLDV</u>	<u>VIVVLSVVAI</u>
EVLLQFLEDQ	NTFP	NLSYPY	DVPDYA	ID	GINIYRTSNV

c) Protected fragment of PC2 (loop 5), HA: 4.7 to 7.8 kDa

IV	*		*	V	
<u>VTVFFVWIKL</u>	FKFIN	FNRTM	SQLST	TMSRC	AKDLF
<u>LAYLVFGTQV</u>	DDL	SYPYDVP	DYAID		<u>GFAIM</u>
					<u>FFIIFLAYAQ</u>

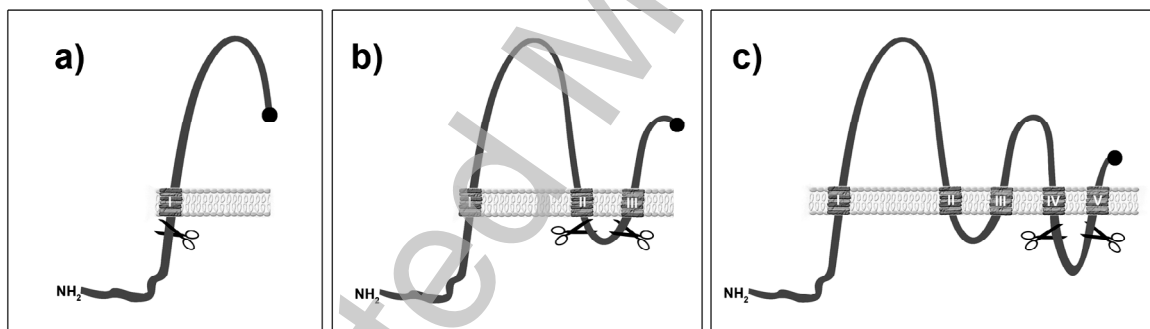

Figure 6. Predicted proteinase K cleavage sites and resulting protected fragments of HA-epitope-tagged polycystin-2 (loop 1), (loop 3) and (loop 5). The amino acid sequences NH₂- and COOH-terminal to transmembrane domains 1, 3 and 5 are shown. Bars above the sequence indicate the transmembrane domains predicted in the original description of polycystin-2 [11] whereas the underlined amino acids indicate the transmembrane helices given in the SwissProt database (accession number Q13563). Asterisks in the putative loops mark the amino acids predicted as accessible to proteinase K within the cytoplasm (schematically shown in the diagrams). Molecular weights of the corresponding HA-epitope-tagged proteolytic fragments are listed next to the respective construct.

THIS IS NOT THE VERSION OF RECORD - see doi:10.1042/BJ20101141

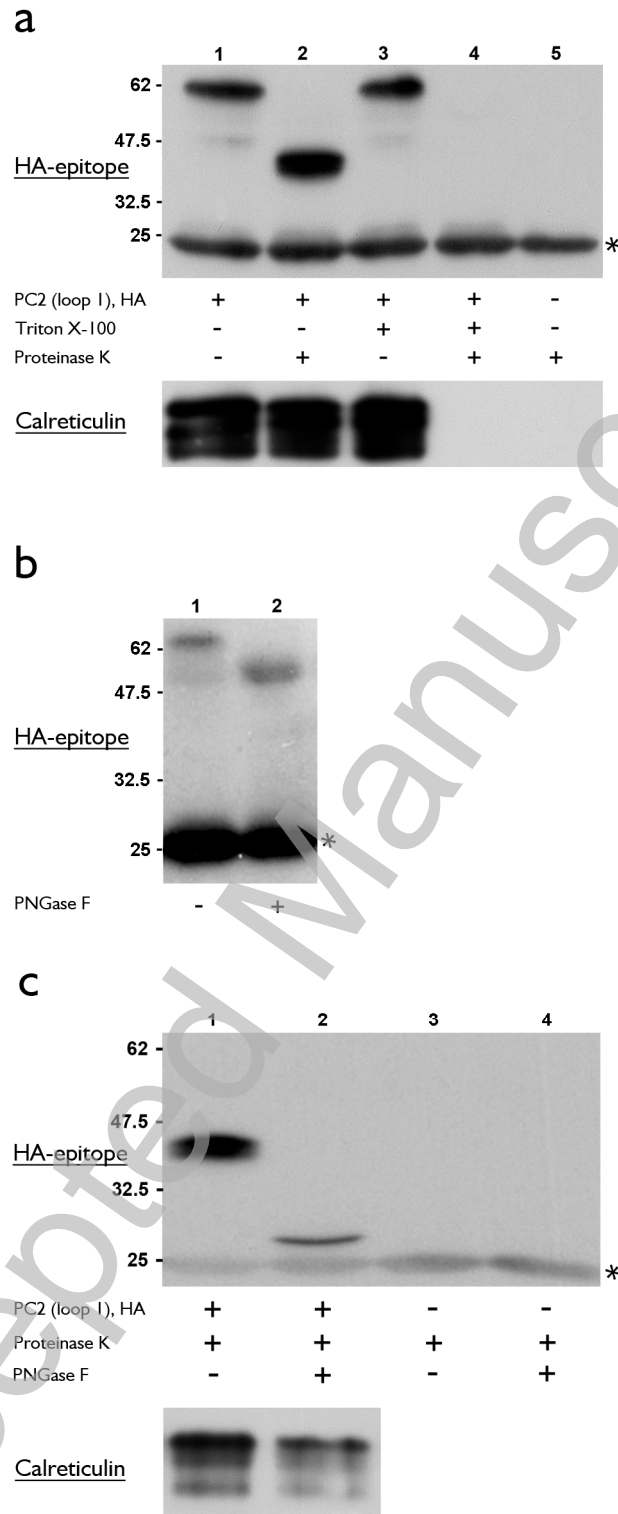

Figure 7. Orientation of loop 1 of human polycystin-2. COS-7 cells were transiently transfected with an expression plasmid encoding polycystin-2 (loop 1), HA. Forty-eight hours later microsomes were prepared and digested with 1 mg/ml of proteinase K in the absence and presence of Triton X-100. (a) After immunoprecipitation with the murine anti-HA-epitope antibody 12CA5 the precipitated proteins were subjected to Western blot analysis with the rat

anti-HA-epitope antibody 3F10. Only in non-permeabilized microsomes a protected fragment was detected, although at a molecular weight nearly twice as high as predicted (lane 2). A Western blot of the supernatant fraction with an anti-calreticulin antibody (lower panel) demonstrates the integrity of the microsomal preparations. (b) Permeabilized microsomes were incubated in the absence or presence of PNGase F, immunoprecipitated with the 12CA5 antibody and subjected to a Western blot with the 3F10 antibody. The shift to a lower molecular weight after PNGase F treatment shows that this deletion mutant of polycystin-2 is *N*-glycosylated. (c) Non-permeabilized microsomes were first incubated with proteinase K and subsequently with PNGase F as indicated. After immunoprecipitation with the 12CA5 antibody and Western blot analysis with the 3F10 antibody a shift to a lower molecular weight was seen in the presence of PNGase F. Asterisks mark the light chain of the antibody.

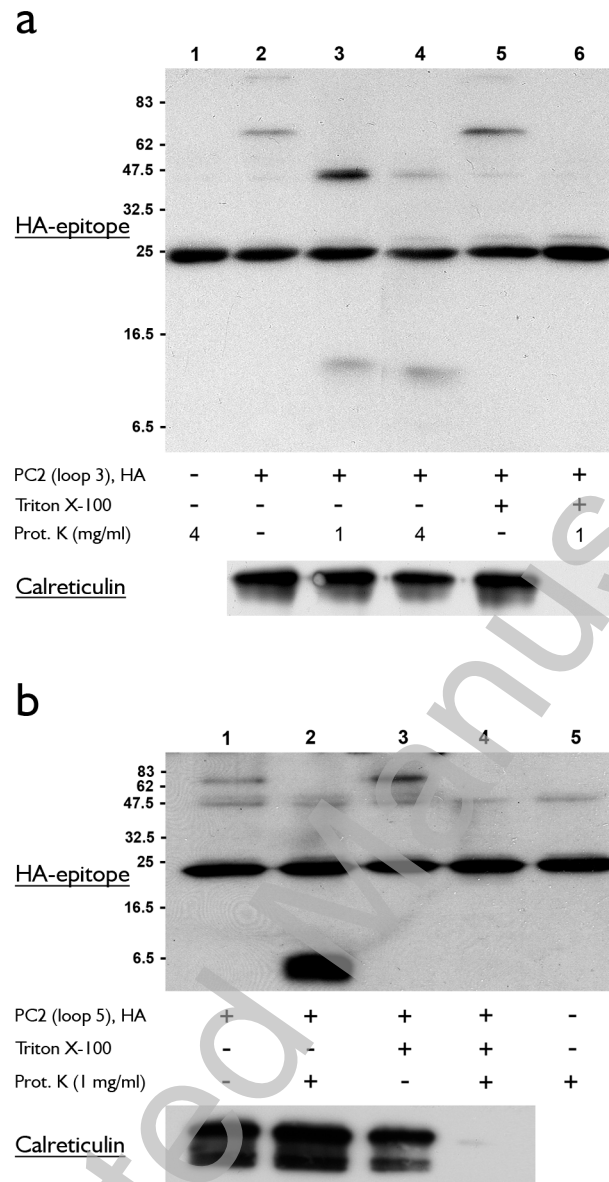

Figure 8. Orientation of loops 3 and 5 of human polycystin-2. COS-7 cells were transiently transfected with an expression plasmid encoding polycystin-2 (loop 3), HA and polycystin-2 (loop 5), HA. Forty-eight hours later microsomes were prepared and digested with proteinase K (Prot. K) in the absence and presence of Triton X-100. (a) Protease protection assay for polycystin-2 (loop 3), HA. The reactions were immunoprecipitated with the murine anti-HA-epitope antibody 12CA5 and subjected to Western blot analysis with the rat anti-HA-epitope antibody 3F10. An excess of proteinase K was necessary to obtain complete digestion which resulted in a protected fragment in the predicted size range (lanes 3 and 4). This argues that loop 3 is present in the lumen of the microsomes. (b) Protease protection assay for polycystin-2 (loop 5), HA. Similar to the finding in panel a the observation of a protected fragment of the expected molecular weight argues that loop domain 5 extends into the lumen of the microsomes (lane 2).

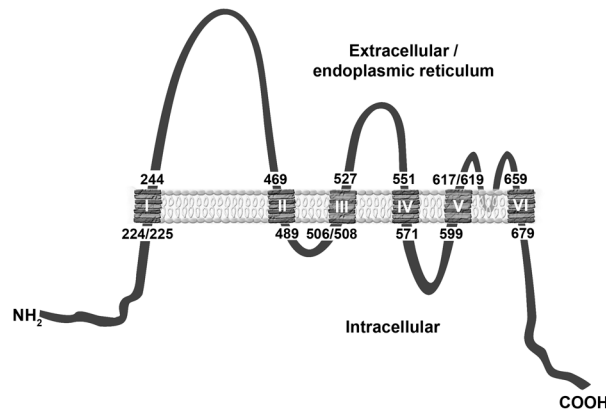

Figure 9. Proposed membrane topology of human polycystin-2. Based on the data obtained in the current study we propose a model in which all six predicted transmembrane segments traverse the membrane. The NH₂- and COOH-termini as well as loops 2 and 4 extend into the cytoplasm whereas loops 1, 3 and 5 extend into the lumen of the endoplasmic reticulum or the extracellular space. The numbers indicate the beginning and the end of each transmembrane segment based on structural predictions [[11], SwissProt database (accession number Q13563)] and our results.

Construct	Sequence
PC2 (fl), HA	... GGNGSSNVHV (968) <u>YPYDVPDYA</u> <i>LE</i>
PC2 (loop 5), HA	... YLVFGTQVDD (625) <i>LS</i> <u>YPYDVPDYA</u> <i>ID</i>
PC2 (loop 4), HA	... LFKFINFNRT (582) <i>LS</i> <u>YPYDVPDYA</u> <i>ID</i>
PC2 (1-577)	... FVWIKLFKFI (577)
PC2 (1-577), HA	... FVWIKLFKFI (577) <i>YLS</i> <u>YPYDVPDYA</u> <i>ID</i>
PC2 (loop 3), HA	... FLEDQNTFPN (547) <i>LS</i> <u>YPYDVPDYA</u> <i>ID</i>
PC2 (loop 2), HA	... IFYYVVEEIL (493) <i>DLS</i> <u>YPYDVPDYA</u> <i>ID</i>
PC2 (loop 1), HA	... VIPSWQFQPL (460) <i>S</i> <u>YPYDVPDYA</u> <i>ID</i>

Table 1. Sequence of polycystin-2 constructs. Shown are the last 10 amino acids of polycystin-2 on the left of each sequence (the numbers in parentheses indicate the position of the most COOH-terminal amino acid of the human polycystin-2 protein). The HA-epitope is underlined, and the italicized residues result from the cloning process.

References

- 1 Gallagher, A. R., Hidaka, S., Gretz, N. and Witzgall, R. (2002) Molecular basis of autosomal-dominant polycystic kidney disease. *Cell. Mol. Life Sci.* **59**, 682-693
- 2 Peters, D. J. M. and Sandkuijl, L. A. (1992) Genetic heterogeneity of polycystic kidney disease in Europe. *Contrib. Nephrol.* **97**, 128-139
- 3 Roscoe, J. M., Brissenden, J. E., Williams, E. A., Chery, A. L. and Silverman, M. (1993) Autosomal dominant polycystic kidney disease in Toronto. *Kidney Int.* **44**, 1101-1108
- 4 Torra, R., Badenas, C., Darnell, A., Nicolau, C., Volpini, V., Revert, L. and Estivill, X. (1996) Linkage, clinical features, and prognosis of autosomal dominant polycystic kidney disease types 1 and 2. *J. Am. Soc. Nephrol.* **7**, 2142-2151
- 5 Wright, A. F., Teague, P. W., Pound, S. E., Pignatelli, P. M., Macnicol, A. M., Carothers, A. D., de Mey, R. J., Allan, P. L. and Watson, M. L. (1993) A study of genetic linkage heterogeneity in 35 adult-onset polycystic kidney disease families. *Hum. Genet.* **90**, 569-571
- 6 American PKD1 Consortium. (1995) Analysis of the genomic sequence for the autosomal dominant polycystic kidney disease (PKD1) gene predicts the presence of a leucine-rich repeat. *Hum. Mol. Genet.* **4**, 575-582
- 7 Hughes, J., Ward, C. J., Peral, B., Aspinwall, R., Clark, K., San Millán, J. L., Gamble, V. and Harris, P. C. (1995) The polycystic kidney disease 1 (*PKD1*) gene encodes a novel protein with multiple cell recognition domains. *Nat. Genet.* **10**, 151-159
- 8 International Polycystic Kidney Disease Consortium. (1995) Polycystic kidney disease: The complete structure of the *PKD1* gene and its protein. *Cell.* **81**, 289-298
- 9 Nims, N., Vassmer, D. and Maser, R. L. (2003) Transmembrane domain analysis of polycystin-1, the product of the polycystic kidney disease-1 (PKD1) gene: Evidence for 11 membrane-spanning domains. *Biochemistry.* **42**, 13035-13048
- 10 Cai, Y., Maeda, Y., Cedzich, A., Torres, V. E., Wu, G., Hayashi, T., Mochizuki, T., Park, J. H., Witzgall, R. and Somlo, S. (1999) Identification and characterization of polycystin-2, the *PKD2* gene product. *J. Biol. Chem.* **274**, 28557-28565
- 11 Mochizuki, T., Wu, G., Hayashi, T., Xenophontos, S. L., Veldhuisen, B., Saris, J. J., Reynolds, D. M., Cai, Y., Gabow, P. A., Pierides, A., Kimberling, W. J., Breuning, M. H., Deltas, C. C., Peters, D. J. M. and Somlo, S. (1996) *PKD2*, a gene for polycystic kidney disease that encodes an integral membrane protein. *Science.* **272**, 1339-1342
- 12 Witzgall, R. (2007) TRPP2 channel regulation. In *Transient receptor potential (TRP) channels* (Flockerzi, V. and Nilius, B., eds.). pp. 363-375, Springer-Verlag, Berlin, Heidelberg
- 13 Petri, E. T., Čelić, A., Kennedy, S. D., Ehrlich, B. E., Boggon, T. J. and Hodsdon, M. E. (2010) Structure of the EF-hand domain of polycystin-2 suggests a mechanism for Ca²⁺-dependent regulation of polycystin-2 channel activity. *Proc. Natl. Acad. Sci. USA.* **107**, 9176-9181
- 14 Schumann, F., Hoffmeister, H., Bader, R., Schmidt, M., Witzgall, R. and Kalbitzer, H. R. (2009) Ca²⁺-dependent conformational changes in a C-terminal cytosolic domain of polycystin-2. *J. Biol. Chem.* **284**, 24372-24383
- 15 Witzgall, R. (2005) Polycystin-2 - an intracellular or plasma membrane channel? *Naunyn-Schmiedeberg's Arch. Pharmacol.* **371**, 342-347
- 16 Pazour, G. J., San Agustin, J. T., Follit, J. A., Rosenbaum, J. L. and Witman, G. B. (2002) Polycystin-2 localizes to kidney cilia and the ciliary level is elevated in *orpk* mice with polycystic kidney disease. *Curr. Biol.* **12**, R378-R380

- 17 Yoder, B. K., Hou, X. and Guay-Woodford, L. M. (2002) The polycystic kidney disease proteins, polycystin-1, polycystin-2, polaris, and cystin, are co-localized in renal cilia. *J. Am. Soc. Nephrol.* **13**, 2508-2516
- 18 Geng, L., Okuhara, D., Yu, Z., Tian, X., Cai, Y., Shibasaki, S. and Somlo, S. (2006) Polycystin-2 traffics to cilia independently of polycystin-1 by using an N-terminal RVxP motif. *J. Cell Sci.* **119**, 1383-1395
- 19 Ausubel, F. A., Brent, R., Kingston, R. E., Moore, D. D., Seidman, J. G., Smith, J. A. and Struhl, K., eds. (1996) *Current Protocols in Molecular Biology*. John Wiley & Sons, New York
- 20 Pendleton, A. R. and Machamer, C. E. (2005) Infectious bronchitis virus 3a protein localizes to a novel domain of the smooth endoplasmic reticulum. *J. Virol.* **79**, 6142-6151
- 21 Argento-Cerù, M. P., Bargagli, A. M. and Sartori, C. (1984) Topological location of diamine oxidase in the transverse plane of rabbit liver microsomal membranes. *Eur. J. Biochem.* **139**, 645-649
- 22 Cai, Y., Anyatonwu, G., Okuhara, D., Lee, K.-B., Yu, Z., Onoe, T., Mei, C.-L., Qian, Q., Geng, L., Witzgall, R., Ehrlich, B. E. and Somlo, S. (2004) Calcium dependence of polycystin-2 channel activity is modulated by phosphorylation at Ser⁸¹². *J. Biol. Chem.* **279**, 19987-19995
- 23 Hidaka, S., Könecke, V., Osten, L. and Witzgall, R. (2004) PIGEA-14, a novel coiled-coil protein affecting the intracellular distribution of polycystin-2. *J. Biol. Chem.* **279**, 35009-35016
- 24 Shental-Bechor, D. and Levy, Y. (2008) Effect of glycosylation on protein folding: A close look at thermodynamic stabilization. *Proc. Natl. Acad. Sci. USA.* **105**, 8256-8261
- 25 Köttgen, M., Benzing, T., Simmen, T., Tauber, R., Buchholz, B., Feliciangeli, S., Huber, T. B., Schermer, B., Kramer-Zucker, A., Höpker, K., Simmen, K. C., Tschucke, C. C., Sandford, R., Kim, E., Thomas, G. and Walz, G. (2005) Trafficking of TRPP2 by PACS proteins represents a novel mechanism of ion channel regulation. *EMBO J.* **24**, 705-716
- 26 Lakkis, M. and Zhou, J. (2003) Molecular complexes formed with polycystins. *Nephron Exp. Nephrol.* **93**, e3-e8
- 27 Li, Q., Montalbetti, N., Shen, P. Y., Dai, X.-Q., Cheeseman, C. I., Karpinski, E., Wu, G., Cantiello, H. F. and Chen, X.-Z. (2005) Alpha-actinin associates with polycystin-2 and regulates its channel activity. *Hum. Mol. Genet.* **14**, 1587-1603
- 28 Wu, Y., Dai, X.-Q., Li, Q., Chen, C. X., Mai, W., Hussain, Z., Long, W., Montalbetti, N., Li, G., Glynne, R., Wang, S., Cantiello, H. F., Wu, G. and Chen, X.-Z. (2006) Kinesin-2 mediates physical and functional interactions between polycystin-2 and fibrocystin. *Hum. Mol. Genet.* **15**, 3280-3292
- 29 Streets, A. J., Moon, D. J., Kane, M. E., Obara, T. and Ong, A. C. M. (2006) Identification of an N-terminal glycogen synthase kinase 3 phosphorylation site which regulates the functional localization of polycystin-2 *in vivo* and *in vitro*. *Hum. Mol. Genet.* **15**, 1465-1473
- 30 Nauli, S. M., Alenghat, F. J., Luo, Y., Williams, E., Vassilev, P., Li, X., Elia, A. E. H., Lu, W., Brown, E. M., Quinn, S. J., Ingber, D. E. and Zhou, J. (2003) Polycystins 1 and 2 mediate mechanosensation in the primary cilium of kidney cells. *Nat. Genet.* **33**, 129-137