



HAL
open science

Automated Micro-assembly tasks based on hybrid Force/position Control.

Kanty Rabenoroso, Cédric Clévy, Philippe Lutz

► **To cite this version:**

Kanty Rabenoroso, Cédric Clévy, Philippe Lutz. Automated Micro-assembly tasks based on hybrid Force/position Control.. 7th International Workshop on Microfactories, IWMF'10., Oct 2010, Daejeon Convention Center, South Korea. pp.89-94. hal-00546353

HAL Id: hal-00546353

<https://hal.science/hal-00546353>

Submitted on 14 Dec 2010

HAL is a multi-disciplinary open access archive for the deposit and dissemination of scientific research documents, whether they are published or not. The documents may come from teaching and research institutions in France or abroad, or from public or private research centers.

L'archive ouverte pluridisciplinaire **HAL**, est destinée au dépôt et à la diffusion de documents scientifiques de niveau recherche, publiés ou non, émanant des établissements d'enseignement et de recherche français ou étrangers, des laboratoires publics ou privés.

Automated Micro-assembly Tasks based on Hybrid Force/Position Control

Kanty Rabenoroso[#], Cédric Clévy and Philippe Lutz

Femto-ST Institute, UMR CNRS 6174, 24 rue Alain Savary, Besançon, France 25000

[#] Corresponding Author / E-mail: rkanty@femto-st.fr, TEL: +33-3-81-40-2784, FAX: +33-3-81-40-2809

KEYWORDS : Micro-assembly, Hybrid force/position control, force sensor, guiding task, ramp tracking

Full automated micro-assembly is an ongoing challenge for researchers. The use of force control constitutes a suitable approach to achieve automated micro-assembly. It takes into account microscale specificities like pull off forces, measurement resolution... The integration of force sensors in micro-assembly station is discussed. An experimental setup is proposed to achieve automated guiding tasks of 2mm x 50 μ m x 50 μ m microparts. It is based on two-sensing-finger microgripper of 2 mN force range. Interaction forces are modeled and used to establish suitable strategy for guiding according to stability conditions and response time. Control scheme which combines force and position control is proposed and its integration to dSPACE board for real time control is achieved. Automated guiding task is performed with dynamic rejection of perturbation within 35 ms and a ramp tracking with a contact force of 20 μ N between the rail side and the micropart is obtained.

1. Introduction

The integration of MEMS (Micro-Electro-Mechanical Systems) and MOEMS (Micro-Opto-Electro-Mechanical Systems) technology in commercial products is growing especially in the field of tele

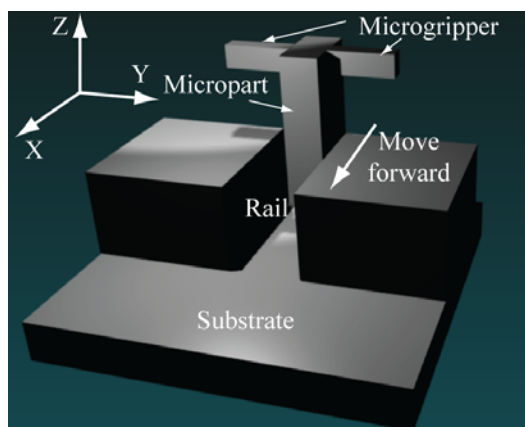

Fig. 1 Description of guiding task.

communication and sensor technology [1]. Heterogeneous microparts produced from various fabrication processes are frequently used for producing complex 3D microstructures through

microparts micro-assembly like [2, 3, and 4]. The use of a robotic workstation at the microscale or even the nanoscale is commonly practiced. Micro-assembly of microparts is usually carried out by precise positioning but this approach is not sufficient for all the micro-assembly tasks [5]. Indeed, the position does not enable the control of interaction forces like gripping force, contact force between the grasped micropart and the substrate. In addition, the integration of the micropositioning sensors on the micro-assembly station is hampered by the size of sensors [6]. In order to achieve automated micro-assembly and to avoid the destruction of microparts, a control of the gripping force is often used [7, 8, 9, and 10]. The detection of contact and the control of the impact force are performed in [11, 12, and 13]. There are some tasks which are carried out by using force control. Insertion tasks are succeeded in [14, 15, and 16]. Pushing is performed in [17, 18]. Considering the guiding task, the grasped micropart is moved along the rail and a contact can appear between the micropart and the sidewall of the rail. This task is described on Fig. 1. This kind of task is useful for automated assembly of reconfigurable micro-optical bench presented in [3] and it can be applied to various other applications. The objective of this paper is to study the automated guiding task of 2 mm x 50 μ m x 50 μ m microparts and the investigation for a suitable control scheme.

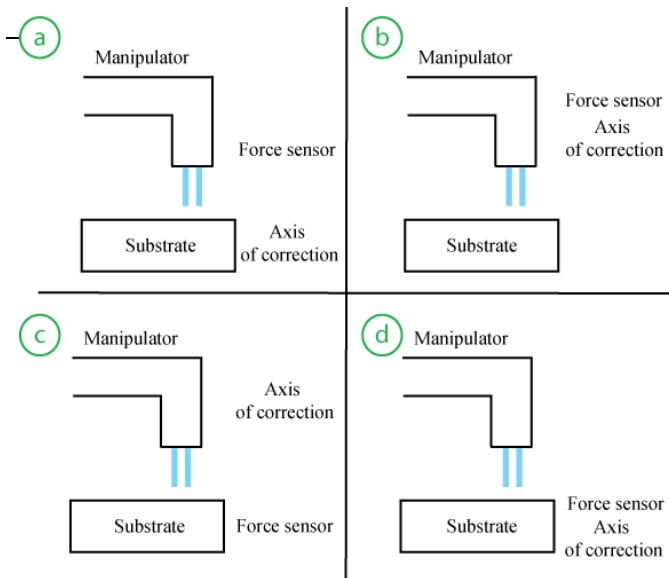

Fig. 2 Configurations of micro-assembly station equipped with force sensor.

Therefore, the integration of force sensor on micro-assembly station is discussed in section 2. An experimental setup is proposed

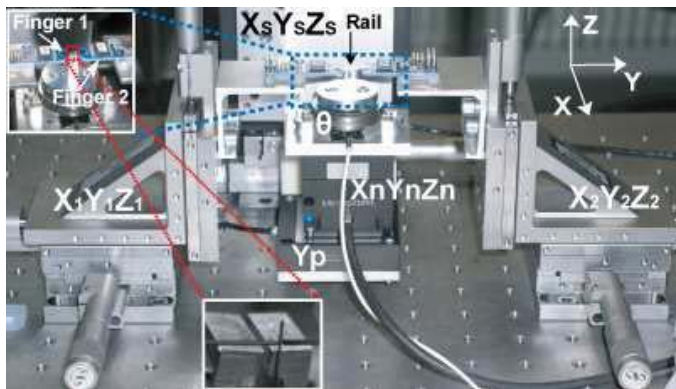

Fig. 3 Experimental setup based on two-sensing-finger microgripper for automated guiding task.

for achieving an automated guiding task in section 3. The detection of contact and the estimation of the lateral contact force are investigated in section 4. Section 5 presents the control scheme and experimental results of automated guiding task.

2. The integration of force sensor on micro-assembly station.

The development of force sensors at the microscale is investigated by many researchers. Their use is generally for micromanipulation and/or micro-assembly. In this aim, their integration on microrobotic system has to be discussed. During micro-assembly, there are some interaction forces: manipulator and his environment (for example the substrate), environment/grasped micropart, gripping forces and perturbation forces. The location of force sensors and axis of correction can be done by 4 configurations

as seen on Fig. 2 :

- The manipulator is equipped with force sensors and the axis of correction is mounted on the substrate.
- The manipulator is equipped with force sensors and the axis of correction is also on it.
- Force sensors are mounted on the substrate and the axis of correction is on the manipulator
- Force sensors and correcting axis are on the substrate.

The choice of the configuration depends on the constraints imposed by the task. The study of the task leads to define directions with unconstrained motion and directions with constrained motion [19, 20]. Force control is applied on the directions with constrained motion. In our case, a lateral contact happens between the grasped micropart and the rail. Motions along Y and Z are constrained contrary to the move forward motion along X. If we consider that the micropart never touches the bottom of the rail, the motion along Z becomes unconstrained. The chosen configuration has to be able to measure the lateral contact force for ensuring his control. For measuring gripping forces and the lateral contact force with a single measurement system, configuration (a) is chosen. We will use a two-sensing-finger microgripper for achieving automated guiding task.

3. Experimental setup.

In this section, the experimental setup is proposed for performing guiding task (see Fig. 3). It is based on two-sensing-finger microgripper based on force sensor probe from FemtoTools with measuring range 2000 μN . Each finger consists in a force sensor used as a jaw of the microgripper and it is mounted on $X_{1,2}Y_{1,2}Z_{1,2}$ linear stages. The displacement of the finger along Y enables to open/close the resulting microgripper. The rail is mounted on a microrobotic system composed of $X_sY_sZ_s$ coarse positioning, Y_p large range but fine positioning stage, $X_nY_nZ_n$ fine positioning, and θ rotation. The large range positioning stage is a P625.1CD from Physik Instrumente with 500 μm travel range and 1.4 nm in resolution. The fine positioning stage is a P611.3 NanoCube® with 100 μm range and 1 nm in resolution. The rotation stage is a SmarAct SR-3610-S with 1.1 μ° in resolution. These three devices are sensorized and closed loop controlled. The rail width is adjustable from 0 to 1 mm enabling to set up the axial play between the guided micropart and the rail.

Considering the micropart manipulated with this microgripper, initial gripping forces applied by each finger are named preload and noted F_{y10}, F_{y20} . They enable to hold the micropart between fingers of the microgripper. The displacement along X enables to position the micropart to the desired position into the rail. When the contact between the rail and the micropart appears, the rail position along Y has to be corrected for canceling the force generated by the contact to preserve the stability and the position of the micropart hold by the microgripper. The lateral contact force has three components: F_x, F_y, F_z and we consider that F_x and F_z are smaller than F_y due to the configuration of the contact. In the following, the microgripper is fixed and the center of the microgripper is defined by a coordinate

frame $X_{micropart} Y_{micropart} Z_{micropart}$. The guiding task is performed by actuating X_n to move forward and by moving Y_n for controlling the contact force. Y_p is used for generating a perturbation (contact happens during the guiding) for misalignment between the rail and guiding axis, nonlinearities of the move forward stage, and the

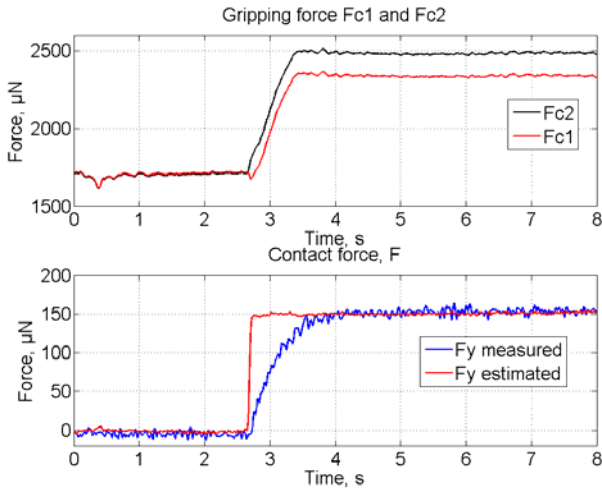

Fig. 4 Estimation of the lateral contact force $F_{y,estimated}$ compared to applying lateral contact force $F_{y,measured}$. $X_{rail} Y_{rail} Z_{rail}$ is the coordinate frame of the rail.

4. Detection of contact and estimation of the lateral contact force.

The objective of this section is the detection of contact and the estimation of the lateral contact force by using the proposed setup.

4.1 Detection of contact

During the move forward motion along X, a contact sometimes appears between the grasped micropart and the sidewall of the rail (see Fig. 1). The use of two-sensing-finger microgripper enables the detection of contact and the identification of contact side. This last one is not possible with only one-sensing-finger microgripper. As shown in [21], the evolution of gripping force is not linear when the lateral contact happens. Typically, there are three steps during the apparition of lateral contact:

- Step 1: measured forces from two fingers are equals without lateral contact.
- Step 2: plane/plane contact is observed between the micropart and the finger tip. During this step, the measured force in the side of contact decreases and the measured force in the opposite side increases.
- Step 3: edge/vertex contact is happened and the two measured forces are increasing.

For identifying the contact side, measured forces from two-sensing-finger are necessary. The highest force value corresponds to the opposite side of contact.

4.2 Estimation of the lateral contact force

The contact force F_y can be evaluated from the equilibrium along Y axis by using the information from two sensors.

$$F_y = F_{y2} - F_{y1} \quad (1)$$

The used force sensors are coupled (the measurement depend on the force applied along Y but also along Z). Expressions of the force on the sensing-fingers are $F_{c1} = F_{y1} + \alpha F_{z1}$ (Finger 1) and $F_{c2} = F_{y2} + \alpha F_{z2}$ (Finger 2) where α is the coupling coefficient. Consequently,

$$F_y = F_{c2} - F_{c1} - 2\alpha F_z \quad (2)$$

The coupling coefficient is small (0.01 given by FemtoTools). F_z is also small during the contact thus $2\alpha F_z$ becomes negligible. The contact F_y can be directly evaluated by equation (3).

$$F_y = F_{c2} - F_{c1} \quad (3)$$

The estimation of the lateral contact force is experimentally performed. A third sensor is used instead of the rail enabling the measurement of the applied force. Details about this third sensor and the experiment setup are given in our previous work [22]. The result is shown in Fig. 4. The evolution of the gripping forces (F_{c1}, F_{c2}) and the comparison of the applied contact force and the estimated contact force are observed. The estimated force is equal to the measured force in static part. The measured force is affected by a slow dynamic due to the third sensor configuration. This result validates the quasi-static estimation of the lateral contact force by using a two-sensing-finger microgripper.

5. Control scheme and experimental results.

For controlling guiding tasks in automated mode, a control of the system is established. The estimated lateral contact force is actively controlled during the move forward motion along X. The magnitude of this force is fixed in accordance to the stability of the grasp. In fact, F_y generates friction force F_x , and this force has to be smaller than (4) as demonstrated on [22]:

$$F_{x,max} = 4F_y \mu R / 3\ell \quad (4)$$

For avoiding the slide and the loss of the micropart, a strategy is established. The move forward motion is stopped when the lateral contact force is bigger than the fixed limit which ensures the stability of the grasp.

5.1 Control scheme

The simultaneous control of force and position can be achieved by hybrid force/position control [23, 24]. The proposed bloc diagram (see Fig. 5) enables to control the position along X during move forward motion and the lateral contact force F_y . Due to the internal controller in the micropositioning stage, the external hybrid force/position control is selected. The $I-S$ matrix defines the axis controlled in force. The bloc E takes into account the strategy for automated guiding task. This bloc has two inputs: the input control of move forward and the magnitude of the lateral contact force.

Position control law is internal to the positioning stage and it is based on PID controller for X, Y, and Z axis.

We propose an incremental control for ensuring quasistatic FCL

(Force Control Law). Fig.6 shows the details of this controller. The use of a dead zone avoids the chattering around the desired force. The limits of the dead zone correspond to the fixed limit of lateral contact force. It ensures the stability of the force control loop without

the tolerable range when the lateral contact force is controlled to the offset value. It avoids the risk to break microparts and guarantee the stability of the grasp. The increase compared to the preload is estimated to 7.9% for 15 μN offset contact force. The desired position along X is reached without micropart sliding thus the task is succeeded.

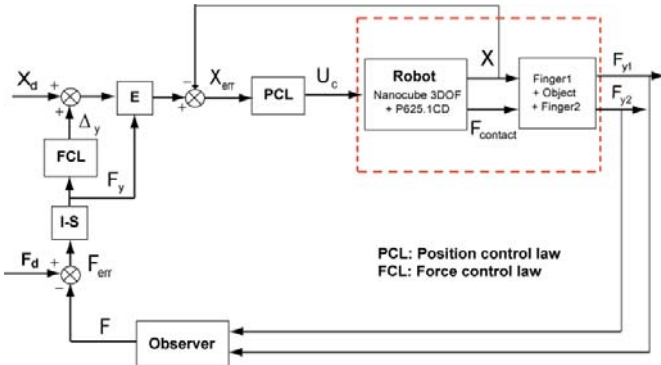

Fig. 5 Bloc diagram of the external hybrid force/position control.

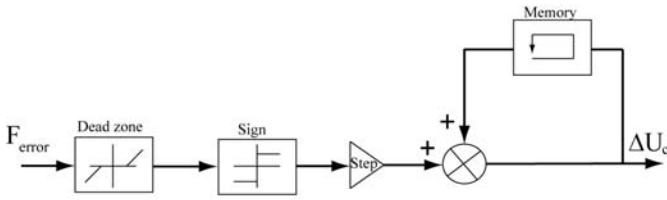

Fig. 6 Bloc diagram of the incremental controller.

tiresome setup of proportional gain. It depends on the sampling frequency F_{ech} and the step size $step$. The choice of these two parameters conducts to the velocity of the correction $V_{corr} = F_{ech} \cdot step$.

5.2 Experimental results

The proposed control scheme is used for achieving the automated guiding task. It is implemented on an 1103 Dspace® board with a sampling frequency $F_{ech} = 100 \text{ Hz}$ and a step size $step = 0.275 \mu\text{m}$. The combination of Matlab/Simulink® and the Dspace board enables to perform a real time control.

First, the micropart is grasped by using the experimental setup (see Fig. 7). Afterwards, the micropart is inserted in the rail and the guiding task can begin. The lateral contact force limit is fixed at 15 μN for taking into account the noise. For simulating a misalignment between the rail axis and the move forward axis, we introduce a ramp perturbation by actuating Y_p . An equivalent angle α of misalignment can be calculated by $\alpha = \tan^{-1}(\Delta_{yp} / \Delta_{xt})$. It is estimated to 26.3° for the presenting result. The result is shown in Fig. 8.

It is observed that when the contact happens, the lateral contact force increases up to the fixed limit. The controller acts to correct the position along Y. The micropart position is slightly out of the rail due to the offset contact force. If the contact appears in the other side, this offset contact force is about 15 μN . Gripping forces are maintained in

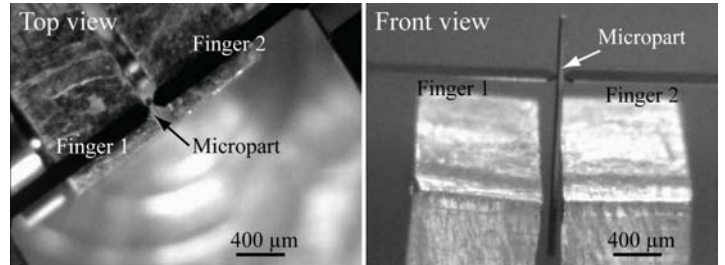

Fig. 7 The grasped micropart is inserted on the rail before the guiding task.

6. Conclusions

In this paper, we have proposed a study of full automated task based on force control. The integration of force sensors on the micro-assembly station is discussed. The chosen configuration enables to measure gripping forces and the lateral contact force. The detection of the contact and the identification of the contact side are completed by using a two-sensing-finger microgripper. An experimental setup is proposed for achieving automated guiding tasks of microparts in size of $2 \text{ mm} \times 50 \mu\text{m} \times 50 \mu\text{m}$. The estimation of the lateral contact force is validated and it is used in the force control loop during the task. A control scheme which ensures the stability of the grasp and achieves the control of contact force between the grasped micropart and the sidewall of the rail is proposed. It is based on an external hybrid force/position control. An incremental controller is used as a force control law. A velocity of correction is fixed by the sampling frequency and the step size. A ramp perturbation is introduced for simulating a misalignment between the rail axis and the move forward axis. It was shown that the proposed control scheme is able to move the micropart along X and to control the lateral contact force under the fixed limit. A fully automated guiding task based on hybrid force/position control can now be achieved using the proposed setup and control law.

ACKNOWLEDGEMENT

These works have partially been supported by Franche-Comté région under MIAMMI project. Authors would like to thank David Guibert for his technical support.

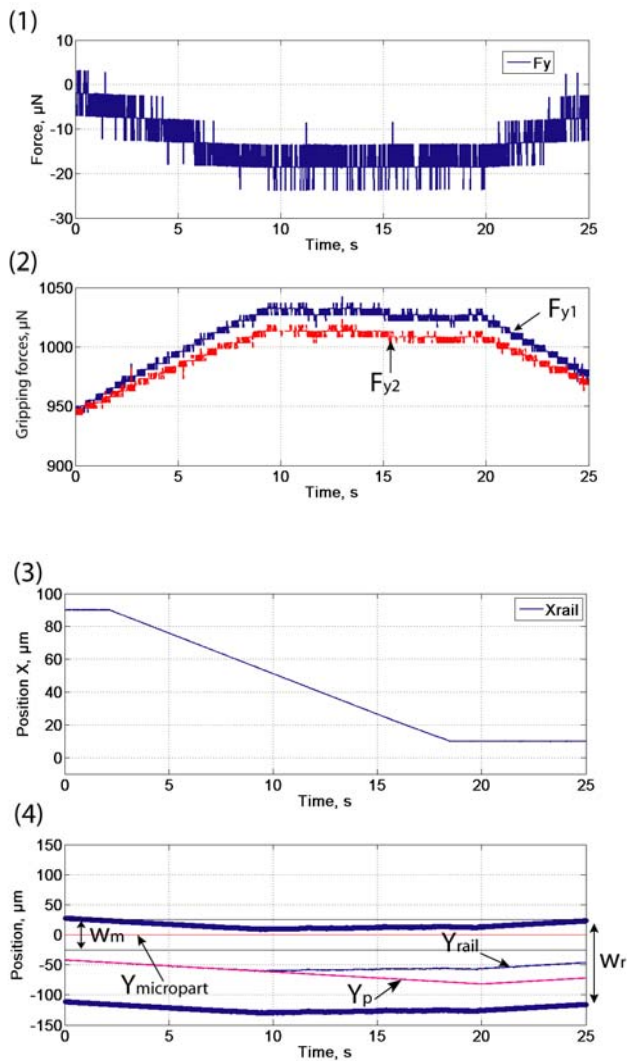

Fig. 8 Experimental result of guiding task: (1) estimation of lateral contact force, (2) gripping forces, (3) move forward displacement, (4) micropart position compared to the rail position.

REFERENCES

1. D. Tolfree and M. J. Jackson, *Commercializing Micro-Nanotechnology Products*. CRC Press, 2006.
2. N. Dechev, W. Cleghorn, and J. Mills, "Microassembly of 3-d microstructures using a compliant, passive microgripper," *Journal of Microelectromechanical Systems*, vol. 13, pp. 176–189, 2004.
3. S. Bargiel, K. Rabenoroso, C. Clévy, C. Gorecki, and P. Lutz, "Towards Micro-Assembly of Hybrid MOEMS Components on a Reconfigurable Silicon Free-Space Micro-Optical Bench", *Journal of Micromechanics and Microengineering*, Vol. 20, pp 1-12, 2010.
4. M. Last, V. Subramaniam and K.S.J. Pister, "Out-of-Plane Motion of Assembled Microstructures using a Single-Mask SOI Process", *International Conference Transducers*, 2005.
5. Z. Lu, P. C. Y. Chen, A. Ganapathy, G. Zhao, J. Nam, G. Yang, E. Burdet, C. Teo, Q. Meng, and W. Lin, "A Force-Feedback Control System for Micro-Assembly," *Journal of Micromech. Microeng.*, vol. 16, pp. 1861–1868, 2006.
6. S. Fahlbusch and S. Fatikow, "Micro Force Sensing in a Microrobotic System," in *IEEE International Conference on Robotics and Automation*, 2001.
7. Y. Shen, N. X. and W. J. Li, "Contact and Force Control in Microassembly," in *IEEE International Symposium on Assembly and Task Planning*, 2003.
8. F. Arai, D. Andou, Y. Nonoda, T. Fukuda, H. Iwata, and K. Itoigawa, "Integrated microendeffector for micromanipulation," *IEEE/ASME Trans. on Mechatronics*, vol. 3, pp. 17–23, 1998.
9. M. C. Carrozza, A. Eisinberg, A. Menciassi, D. Campolo, S. Micera, and P. Dario, "Towards a Force-Controlled Microgripper for Assembling Biomedical Microdevice," *Journal of Micromech. Microeng.*, vol. 10, pp 271–276, 2000.
10. F. Beyeler, A. Neild, S. Oberti and D. J. Bell, Y. Sun, J. Dual and Bradley J. Nelson, "Monolithically Fabricated Microgripper With Integrated Force Sensor for Manipulating Microobjects and Biological Cells Aligned in an Ultrasonic Field", *Journal of Microelectromechanical Systems*, Vol. 16, pp. 7-16, 2007.
11. W. L. Xu, J. D. Han, and S. K. Tso, "Experimental Study of Contact Transition Control incorporating Joint Acceleration Feedback," *IEEE/ASME Trans. on Mechatronics*, vol. 5, pp. 292–301, 2000.
12. R. Volpe and P. Khosla, "A Theoretical and Experimental Investigation of Impact Control for Manipulators," *IEEE Trans. on Automatic Control*, vol. 12, pp. 351–365, 1993.
13. Y. Zhou, B. J. Nelson, and B. Vikramaditya, "Fusing Force and Vision Feedback for Micromanipulation," in *IEEE International Conference on Robotics and Automation*, 1998.
14. J. Wason, W. Gressick, J. T. Wen, J. Gorman, and N. Dagalakis, "Multiprobe Micro-Assembly," in *IEEE Conference on Automation Science and Engineering*, 2007, pp. 63–68.
15. W. H. Lee, B. H. Kang, Y. S. Oh, and H. Stephanou, "Micropeg Manipulation with a Compliant Microgripper", in *IEEE International Conference on Robotics and Automation*, 2003.
16. Z. Lu, P. C. Y. Chen, A. Ganapathy, G. Zhao, J. Nam, G. Yang, E. Burdet, C. Teo, Q. Meng and W. Lin, "A Force-Feedback Control System for Micro-Assembly", *Journal of Micromechanics and Microengineering*, Vol. 16, pp 1861-1868, 2006.
17. S. Khan and A. Sabanovic, "Hybrid Vision/Force Feedback Control for Pushing Micro-Objects," in *IEEE/RSJ IROS*, 2009.
18. W. Zesch and R. S. Fearing, "Alignment of Microparts Using

- Force Controlled Pushing”, 1998.
19. M. T. Mason, “Compliance and Force Control for Computer Controlled Manipulators”, Massachusetts Institute of Technology, 1979.
 20. T. Lefebvre, J. Xiao, H. Bruyninckx and G. de Gerssem, “Active compliant motion: a survey”, *Advanced Robotics*, Vol. 19, pp 479-499, 2005.
 21. K. Rabenorosoa and C. Clévy and Q. Chen and P. Lutz, “Study of Forces during Micro-Assembly Tasks using Two-Sensing-Finger Grippers”, *IEEE/ASME Transactions on Mechatronics*, Submitted.
 22. K. Rabenorosoa, C. Clévy, and P. Lutz, “Active Force Control for Robotic Micro-Assembly: Application to guiding tasks,” in *IEEE International Conference on Robotics and Automation*, 2010.
 23. W. D. Fisher and M. S. Mujtaba, “Hybrid PositionIForce Control: A Correct Formulation”, *International Journal of Robotics Research*, Vol. 11, pp 299-311, 1992.
 24. V. Perdereau and M. Drouin, “A new scheme for hybrid force-position control,” *Lecture Notes in Control and Information Sciences*, Vol. 187, pp. 150–159, 1993.