



HAL
open science

Signal Amplification in Biological and Electrical Engineering Systems

Vladimir Grubelnik, Bogdan Dugonik, Davorin Osebik, Marko Marhl

► **To cite this version:**

Vladimir Grubelnik, Bogdan Dugonik, Davorin Osebik, Marko Marhl. Signal Amplification in Biological and Electrical Engineering Systems. Biophysical Chemistry, 2009, 143 (3), pp.132. 10.1016/j.bpc.2009.04.009 . hal-00545278

HAL Id: hal-00545278

<https://hal.science/hal-00545278>

Submitted on 10 Dec 2010

HAL is a multi-disciplinary open access archive for the deposit and dissemination of scientific research documents, whether they are published or not. The documents may come from teaching and research institutions in France or abroad, or from public or private research centers.

L'archive ouverte pluridisciplinaire **HAL**, est destinée au dépôt et à la diffusion de documents scientifiques de niveau recherche, publiés ou non, émanant des établissements d'enseignement et de recherche français ou étrangers, des laboratoires publics ou privés.

Accepted Manuscript

Signal Amplification in Biological and Electrical Engineering Systems

Vladimir Grubelnik, Bogdan Dugonik, Davorin Osebik, Marko Marhl

PII: S0301-4622(09)00088-X
DOI: doi: [10.1016/j.bpc.2009.04.009](https://doi.org/10.1016/j.bpc.2009.04.009)
Reference: BIOCHE 5257

To appear in: *Biophysical Chemistry*

Received date: 23 November 2008
Revised date: 29 April 2009
Accepted date: 30 April 2009

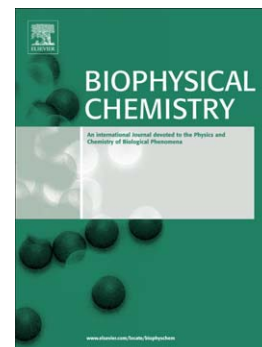

Please cite this article as: Vladimir Grubelnik, Bogdan Dugonik, Davorin Osebik, Marko Marhl, Signal Amplification in Biological and Electrical Engineering Systems, *Biophysical Chemistry* (2009), doi: [10.1016/j.bpc.2009.04.009](https://doi.org/10.1016/j.bpc.2009.04.009)

This is a PDF file of an unedited manuscript that has been accepted for publication. As a service to our customers we are providing this early version of the manuscript. The manuscript will undergo copyediting, typesetting, and review of the resulting proof before it is published in its final form. Please note that during the production process errors may be discovered which could affect the content, and all legal disclaimers that apply to the journal pertain.

Signal Amplification in Biological and Electrical Engineering Systems.

Universal Role of Cascades

Vladimir Grubelnik^{1,2}, Bogdan Dugonik³, Davorin Osebik⁴, Marko Marhl^{1,*}

¹Department of Physics, Faculty of Natural Sciences and Mathematics, University of Maribor,
Koroška cesta 160, SI-2000 Maribor, Slovenia

²Institute of Mathematics and Physics, ³Laboratory of Electronic Systems, ⁴Laboratory of
Microcomputer Systems, Faculty of Electrical Engineering and Computer Science,
University of Maribor, Smetanova 35, SI-2000 Maribor, Slovenia

Correspondence to:

Professor Marko Marhl, PhD

Dept. of Physics, Faculty of Natural Sciences and Mathematics, University of Maribor

Koroška cesta 160, SI-2000 Maribor

Tel.: +386 2 2293643; Fax: +386 2 251 8180

E-mail: marko.marhl@uni-mb.si; URL: www.marhl.com

Abstract – In this paper we compare the cascade mechanisms of signal amplification in biological and electrical engineering systems, and show that they share the capacity to considerably amplify signals, and respond to signal changes both quickly and completely, which effectively preserves the form of the input signal. For biological systems, these characteristics are crucial for efficient and reliable cellular signalling. We show that this highly-efficient biological mechanism of signal amplification that has naturally evolved is mathematically fully equivalent with some man-developed amplifiers, which indicates parallels between biological evolution and successful technology development.

Key Words: Multi-Stage Amplifier, Protein Cascade, Cellular Signalling, Laplacean transformation.

1. Introduction

Cellular signalling is one of the crucial processes enabling normal functioning of biological systems. The complexity of cellular signalling depends on the complexity of living organisms and on the cell type. In prokaryotes, for example, simple one- and two-component systems link external signals with cellular responses [1, 2]. In plant and animal cells, signalling networks can be highly complex, some networks comprising of 60 or more proteins [3]. The cell appears to use complex biochemical networks, in particular intracellular signalling cascades, to regulate multiple functions [4]. The control of gene expression, for example, typically involves the integration of many signals and employs complex enzymatic networks, which effectively implement logical functions [5, 6, 7]. In contrast, olfaction and photoreception involve simpler enzymatic cascades which may be thought of as adaptive amplifiers or transducers [8-10] that detect an extracellular stimulus and convert it into an intracellular signal that can effectively control the information content of the cellular output signal, i.e., neurotransmitter release [11].

Signal amplification is an important issue concerning inter- and intra-cellular signalling. The notion that a protein cascade could amplify signals was understood at least as far back as the 1960's [12, 13], particularly in relation to blood clotting [3]. Cascades have been classically viewed as signal amplifiers [14-16]. The amplification can be achieved in an enzymatic pushpull loop [17, 18]. Signalling pathways are made up of a complex web of enzyme cascades, some of which are known to be highly conserved across living systems [19]. Depending on their regulatory design, protein cascades have been shown to exhibit signal amplification [17, 18, 20-24]. The common view is that the multi-step protein kinase cascades allow large signal amplification, in the same way that

a photo-multiplier tube converts a small pulse of photons into a large photocurrent, for example [14]. It has been proven mathematically that the overall sensitivity of a linear cascade is the product of the sensitivities at each level of the cascade [15, 25].

Protein cascades as amplifiers have been extensively studied. Not only the factor of amplification was of interest, but also how fast the signal arrives at its destination and how long the signal lasts [26-29]. For linear kinase-phosphatase cascades, Heinrich et al. [26] have shown that phosphatases have a more pronounced effect than kinases on the rate and duration of signalling, whereas signal amplitude is controlled primarily by kinases. Marhl and Grubelnik [30] show that protein kinase cascades enable converting oscillatory signals into sharp stationary step-like outputs. One of the most known properties of the signal cascade cycle is ultrasensitivity [17, 21, 23, 31, 32], that is, the property of both species in the cycle to switch rapidly in opposite directions in response to a change in the input signal. This behaviour is the resemblance to a man-made device, the transistor [3].

Several studies have been devoted to comparing biological cascade cycles with electronic circuits. For example, metabolic pathways have been compared with electronic circuits by Balaji [33]. Enzymatic amplification was analyzed in engineering terms of gain, bandwidth, noise and power [11]. Basic logic gates were constructed from single cascade cycles [3]. It has also been found that a protein cascade can function as a low-pass filter [34, 35] and as a band-pass filter [36, 37]. The cascades also play important role in filtering out noise [38].

In this paper we compare biological cascade cycles with electronic circuits. We analyse the effectiveness of protein cascades as amplifiers and compare their properties

with those of electrical amplifier consisting from a series of electrical amplifier wired in a cascade. We compare two main characteristics of the amplifiers: the factor of amplification and the preservation of the form of the amplified output signal. It is not only important that the output signal is strongly amplified but the form of the amplified output signal should be preserved in order to follow the input signal. As criteria for an optimal response we take the high amplification in the sense of high effectiveness and at the same time the highly preserved form of the input signals. In particular, we are interested in the amplification of non-harmonic signals, like for example, in biological systems calcium oscillations are. For these non-harmonic oscillations the preservation of the signal form is analysed mathematically by comparing the corresponding frequency spectra.

In electrical engineering, several active electronic elements are known, which are used as amplifiers. Well-known amplifiers are uni- and bi-polar transistors. The problem of these amplifiers is that their factors of amplification are rather low and do not usually exceed a factor of 100. Higher amplification factors can be obtained by appropriate wiring of these basic elements. One of most known examples of such combination of transistors is the differential amplifier, which is an integrative part of every operational amplifier. The term "operational amplifier" goes all the way back to about 1943 where this name has been coined by Ragazzinni and Philbrick [39].

Today the operational amplifier is almost indispensable part of any electronic circuit. Its factor of amplification depends on the frequency, since it acts as a low-pass frequency filter [40]. This is very similar to basic enzymatic amplifiers [11]. For protein cascades, *e.g.*, MAPK cascade [34, 35], it has been shown that they act as low-pass frequency filter.

If an amplifier acts as a low-pass frequency filter, it means that higher frequencies are cut off and the output signal is deformed. The extent of the signal deformation depends on the frequency spectrum lost in this process.

Operational amplifiers can further be combined into cascades in order to get larger amplifications. This is known as multi-stage amplifier. In the present paper multi-stage electrical amplifier are compared with multi-step protein cascades acting as biological amplifiers. We show that a direct analogy between the electrical and biological amplifiers exists. Moreover, mathematical evidence is given that the dynamics of both amplifiers is identical if for protein cascades linearised equations are considered. Our results show that cascades play crucial role in both electrical and biological amplifiers in order to achieve high amplification factors and fast response to input signals, which preserve the form of input signals. This characteristic of amplifiers is very important and highly appreciated in different technical systems. In the field of telecommunication and optical communication, converting optical into electrical signals, for example, a large amount of data with high-speed conversion needs to be transferred (high data capacity transfer) which can only be provided by broad pass frequency data transfer. The amplifiers must work in a very broad pass frequency regime. It is important that the information does not go lost; the signals must be amplified without or with minimal deformation. With cascade amplifiers (the so-called broadband frequency response amplifiers) the highest upper-frequency limits of more than 10 GHz, in some cases more than 100 GHz, can be reached [41-43].

The paper is organised as follows. First, signal amplification in biological cells is analysed by using a simple mathematical model for 1-step and multi-step protein cascades. In particular, frequency characteristics of the cellular amplifiers are analysed.

In Section 3 multi-stage electrical amplifiers are studied. In the last two sections a detailed comparison between the biological and electrical amplifiers is provided. We mathematically confirm the analogy between the linearised set of model equations describing the dynamics of the biological amplifier and the equations for the multi-stage electrical amplifier.

2. Signal amplification in biological cells

In biological cells, protein cascades act as signal amplifiers. Here a simplified model of protein cascades is considered in which each kinase has only one phosphorylation site, as it can be found in several previous studies; for example, it has been applied for studying time courses of signal transfers through cascades [26, 28, 29], selective decoding [37] and smoothening of cellular signals [30]. The scheme of the protein cascade used in our analyses is shown in Figure 1. It can be considered as a minimal model of cascade amplifiers with basic mechanisms providing signal amplification in biological cells. The model is general in the sense that different input signals can be amplified; however, as an example of typical non-harmonic signals we take Ca^{2+} oscillations, usually observed in experiments as spiking oscillations [43]. According to this, at the first level the proteins are activated by Ca^{2+} binding, than the activated first-level proteins further activate the proteins at the second level, etc. The concentration of the free cytosolic Ca^{2+} in the cell is denoted by x , active forms of proteins at i -th level by z_i , $i=1,2,\dots,n$, and the kinetic constants for binding and dissociation by k_{on} and k_{off} , respectively.

Figure 1

2.1. Mathematical model of cellular amplifier

The dynamics of the protein activation at the i -th level is gained by the following differential equations:

$$\frac{dz_1}{dt} = k_{\text{on}} x (z_{\text{tot}} - z_1) - k_{\text{off}} z_1. \quad (1a)$$

$$\frac{dz_i}{dt} = k_{\text{on}} z_{i-1} (z_{\text{tot}} - z_i) - k_{\text{off}} z_i, \quad i = 2, 3, \dots, n. \quad (1b)$$

For simplicity reasons, k_{on} , k_{off} , and z_{tot} have the same values in all cascade levels. This also seems to be of some physiological importance since for the steady-state responses of protein kinase networks it has been shown that the most efficient cascade design for generating sharp signals has equal on rates, and to achieve the highest amplification and the shortest duration response, the cascade should have equal off rates [28]. In all calculations $z_{\text{tot}} = 100\mu\text{M}$, whereas values for k_{on} , k_{off} changes and are specified in the text and figure captions for particular calculations.

2.2. Results for cellular amplifiers

We analyse responses of the protein cascade amplifier to a step-like input signal, which can be mathematically described as:

$$x(t) = \begin{cases} x_{\text{max}}, & \text{if } t_{\text{init}} < t < d \\ x_{\text{min}}, & \text{else} \end{cases}, \quad (2)$$

where x_{min} and x_{max} are the minimum and maximum of the input signal, respectively, t_{init} is the initial quiescent time, and d is the duration of the signal. We take $x_{\text{max}} = 1\mu\text{M}$ and $x_{\text{min}} = 0\mu\text{M}$ in all calculations.

2.2.1. Responses of the 1-step cascade amplifier

First we analyse responses of the 1-step cascade (Eq. (1a)) to the step-like input signal (Eq. (2)). The maximal amplification of the signal depends on the maximal steady-state value of z_1 :

$$z_{1,ss} \Big|_{x=x_{\max}} = \frac{x_{\max}}{K + x_{\max}} z_{\text{tot}}, \quad (3)$$

where K is the dissociation constant defined as $K = k_{\text{off}}/k_{\text{on}}$. The maximal amplification, $A_{1,ss}$, is defined as the quotient between the $z_{1,ss} \Big|_{x=x_{\max}}$ and the x_{\max} :

$$A_{1,ss} = \frac{z_{1,ss} \Big|_{x=x_{\max}}}{x_{\max}} = \frac{1}{K + x_{\max}} z_{\text{tot}} \quad (4)$$

Equation (4) shows that for a given value of x_{\max} and z_{tot} the amplification is uniquely determined by K . For $x_{\max} = 1\mu\text{M}$ and $z_{\text{tot}} = 100\mu\text{M}$ the amplification $A_{1,ss}$ is presented in dependence on the dissociation constant K in Fig. 2. It is evident that for large amplifications small values of K are required.

Figure 2

Although the signal amplification is uniquely defined by the dissociation constant K , the form of the amplified output signal depends on the rate constants k_{on} and k_{off} . Figure 3 shows three amplified signals for a fixed value of k_{on} and three different values of k_{off} . The problem, demonstrated in Fig. 3, is that at high amplifications the form of the input

signal is deformed and the question arises if high amplifications are possible with a well-preserved form of the input signal.

Figure 3

A simple mathematical analysis shows how the form of amplified signals depends on the rate constants k_{on} and k_{off} (see also [37]). When the input signal turned on, *i.e.*, $x = x_{\text{max}}$, the protein dynamics is determined by the following function:

$$z_1 = z_{1,\text{ss}} \left(1 - e^{-(k_{\text{off}} + k_{\text{on}} x_{\text{max}})t} \right). \quad (5)$$

When the input signal turned off, *i.e.*, $x = x_{\text{min}} = 0\mu\text{M}$, the protein dynamics can be described as:

$$z_1 = z_{1,\text{ss}} e^{-k_{\text{off}}t}. \quad (6)$$

By using Eqs. (5) and (6) the times of switch-on, t_{on} , and switch-off, t_{off} , can be calculated. The t_{on} is defined as the time in which z_1 changes its value from 10% to 90% of the $z_{1,\text{ss}}$:

$$t_{\text{on}} = \ln \left(\frac{1 - \gamma_1}{1 - \gamma_2} \right) \frac{1}{k_{\text{off}} + k_{\text{on}} x_{\text{max}}}, \quad (7)$$

where $\gamma_1 = 0.9$ and $\gamma_2 = 0.1$. The switch-off time, t_{off} , is defined as the time in which the z_1 changes its value from 90% to 10% of the $z_{1,\text{ss}}$:

$$t_{\text{off}} = \ln \left(\frac{\gamma_2}{\gamma_1} \right) \frac{1}{k_{\text{off}}}. \quad (8)$$

Equations (7) and (8) show that for sharp step-like responses large values of k_{on} and k_{off} are required; then t_{on} and t_{off} are small. If at the same time the signals should be highly amplified, the ratio $K = k_{\text{off}}/k_{\text{on}}$ has to be small according to Eq. (4). This means that for high amplified sharp step-like responses we need small values of K and large values of k_{on} and k_{off} . If k_{off} needs to be large, and at the same time K should be small, then the k_{on} has to be very large, *i.e.*, $k_{\text{on}} \gg k_{\text{off}}$. The problem is that for sharp step-like and highly amplified signals very large values of k_{on} would be needed, which mostly exceed the physiological values (*e.g.* [45]). One can conclude that for physiologically relevant values of the rate constants signal amplification, in which signals would be highly amplified and their form preserved, is not possible with 1-step protein cascades. The signal either preserves its form and is weakly amplified, or the input signal is highly amplified but changes its form (see Fig. 2). In the next paragraph we show that the problem can be solved by n -step protein cascades.

2.2.2. Responses of the n -step cascade amplifier

Similar to Eq. (3) the maximal steady-state concentrations of activated proteins at each cascade level are given by:

$$z_{i,\text{ss}} \Big|_{x=x_{\text{max}}} = \frac{z_{i-1,\text{ss}} \Big|_{x=x_{\text{max}}}}{K + z_{i-1,\text{ss}} \Big|_{x=x_{\text{max}}}} z_{\text{tot}}, \quad i = 1, 2, 3, \dots, n, \quad (9)$$

where $z_{0,\text{ss}} \Big|_{x=x_{\text{max}}} = x_{\text{max}}$. The steady-state concentrations of activated proteins depends

recursively on each other:

$$z_{i,\text{ss}} \Big|_{x=x_{\text{max}}} = a_i z_{i-1,\text{ss}} \Big|_{x=x_{\text{max}}} = A_{i,\text{ss}} x_{\text{max}}, \quad (10)$$

where $a_i = z_{\text{tot}} / \left(K + z_{i-1, \text{ss}} \Big|_{x=x_{\text{max}}} \right)$ and $A_{i, \text{ss}} = a_1 a_2 \dots a_i$. Taking into account relations

$A_{i, \text{ss}} = A_{i-1, \text{ss}} a_i$ and $z_{i-1, \text{ss}} = A_{i-1, \text{ss}} x_{\text{max}}$, the maximal signal amplification at the i -th cascade level, $A_{i, \text{ss}}$, is given by the following expression:

$$A_{i, \text{ss}} = \frac{A_{i-1, \text{ss}}}{K + A_{i-1, \text{ss}} x_{\text{max}}} z_{\text{tot}}, \quad i = 1, 2, 3, \dots, n, \quad (11)$$

where $A_{0, \text{ss}} = 1$. In Fig. 4a the maximal signal amplification $A_{i, \text{ss}}$ is presented in dependence on the dissociation constant K . The results, given for five different cascade levels, indicates the convergence of the amplification for $i \rightarrow \infty$. When $A_{i, \text{ss}}$ converges to a limit value, then $A_{i, \text{ss}} \approx A_{i-1, \text{ss}}$ for $i \rightarrow \infty$, and by using Eq. (11) the limit $A_{n, \text{ss} \rightarrow \infty}$ can be estimated by the following expression (dashed line in Fig. 4a):

$$A_{n, \text{ss} \rightarrow \infty} = \frac{z_{\text{tot}} - K}{x_{\text{max}}}. \quad (12)$$

Figure 4a shows that multi-step cascades with increasing i enable large amplifications also at higher values of K . This solves the previous problem of the 1-step cascade, where due to the condition $k_{\text{on}} \gg k_{\text{off}}$, very large values of k_{on} were needed in order to obtain small values of $K = k_{\text{off}}/k_{\text{on}}$ and hence large signal amplifications. Figure 4b demonstrates the effectiveness of a multi-step cascade amplifier for the same parameter values as taken in Fig. 3, *i.e.*, $k_{\text{on}} = 1 \mu\text{M}^{-1}\text{s}^{-1}$ and $k_{\text{off}} = 10 \text{s}^{-1}$. It is evident that the output signal is efficiently amplified and the form of the input signal is well preserved. The switch-off of the output signal is characterised by a time delay, the so-called memory time, appearing as a consequence of the chain-protein-deactivation (see [30]).

Figure 42.2.3 Frequency characteristics of cellular amplifiers

A comparison of Figs. (3) and (4b) shows that signal amplification is possible both with 1-step cascade and multi-step cascades. However, the signal amplification with multi-step cascades is much more useful since the form of the signal is better preserved. To quantify mathematically in how much extent the form of the input signal is preserved by the signal amplification, we analyse the frequency characteristics of the amplifiers.

In Fig. 5a the frequency characteristics of the 1-step cascade amplifier is shown for exactly the same parameter values as taken in Fig. 3. The characteristics was obtained by inserting $x(t) = x_{\max} \sin(\omega t)$, where $\omega = 2\pi f$, into Eq. (1a) and plotting the ratio between the amplitudes of output and input signal, $A_1 = z_{1,\max}/x_{\max}$, vs. f . The results show that the amplifier acts as a low-pass frequency filter, which means that higher frequency are cut off and the output signal is correspondingly deformed. The extent of the signal deformation depends on the frequency spectrum lost in this process. We see that the smallest portion of the high-frequency spectrum is cut off for $k_{\text{off}} = 10\text{s}^{-1}$, which is fully in accordance with the best preserving form of the signal in Fig. 3. It is also evident that $A_1 \rightarrow A_{1,\text{ss}}$ for $f \rightarrow 0$, which is in accordance with Eq. (4).

How the frequency characteristic of a 1-step amplifier is improved by higher levels of cascades, is shown in Fig. 5b for the case of amplification $A_{i,\text{ss}} = 50$, as obtained in Fig. 5a for $k_{\text{off}} = 1\text{s}^{-1}$. It should be noted, however, if we would like to preserve the same amplification $A_{i,\text{ss}} = 50$ (see Eq. (11)) for all i , the values of k_{off} have to be accordingly

modified; in our case: $k_{\text{off}} = 1\text{s}^{-1}$ for the 1-step cascade amplifier, $k_{\text{off}} = 9.51\text{s}^{-1}$ for the 2-step cascade amplifier, and $k_{\text{off}} = 19.7\text{s}^{-1}$ for the 3-step cascade amplifier. The characteristics in Fig. 5b were calculated in the same way as in Fig. 5a, by inserting $x(t) = x_{\text{max}} \sin(\omega t)$ into Eq. (1a) and plotting the corresponding $A_i = z_{i,\text{max}}/x_{\text{max}}$ vs. f .

Figure 5

We also made some calculations with double phosphorylation as well as with integrated feedbacks from the last level of the cascade back to the first level. We didn't observe any considerable changes in the above presented results. Furthermore, we also made additional calculations taking into account different values of z_{tot} at different cascade levels. As usually stated in the literature [46, 47, 48], we take lower z_{tot} at the first level and larger values of z_{tot} at the second and third level. Also in this case we didn't observe any considerable changes in our results.

3. Cascade amplifiers in electrical engineering

Cascade amplifiers are also well-known in electrical engineering [40]. In Fig. 6a a cascade of three non-inverting operational amplifiers is presented. The U_0 is the voltage of the input signal, and U_1 , U_2 in U_3 are the voltages of the amplified output signals at the 1st, 2nd, and 3rd cascade step, respectively. The amplification is defined by resistors R_1 and R_2 .

Figure 6

First we analyse signal amplification for only one operational amplifier TL082. We take $U(t) = U_0 \sin(\omega t)$ as the input signal and measure the amplified output signal. We simulate the experiment with the computer program “Electronics Workbench – Multisim 9” [49]. The results are presented in Fig. 7a. The maximal amplification of the 1-stage amplifier, $A_{u,1}$, is defined as the quotient between the maxima of the output, U_1 , and the input signal, U_0 , *i.e.*, $A_{u,1} = U_1 / U_0$. The simulation was carried out for three different values of R_2 , while R_1 is constant, $R_1 = 1\text{k}\Omega$. Figure 7a shows that larger amplifications are obtained for larger values of R_2 . However, despite the larger signal amplifications for larger values of R_2 , the maximum operating frequency of the amplifiers are higher for smaller values of R_2 . This resembles the situation observed for cellular amplifiers in Fig. 5a.

When simulating the signal amplification by the three-stage amplifier (using TL082), the results (Fig. 7b) resemble those obtained in Fig. 5b. Figure 7b shows that the frequency characteristic of the 1-step amplifier can be significantly improved by higher levels of cascades. We improve the frequency characteristics of the 1-step amplifier shown in Fig. 7a for $R_2 = 99\text{k}\Omega$. The amplification $A_{u,i} = 100$ (in stationary state, *i.e.*, for $f \rightarrow 0$) is hold constant, whereas the number of cascade levels, i , is changed. This requires concomitant changing of the resistance R_2 ; in our case: $R_2 = 99\text{k}\Omega$ for the one-stage, $R_2 = 9\text{k}\Omega$ for the two-stage, and $R_2 = 3.64\text{k}\Omega$ for the three-stage amplifier.

Figure 7

Similar to Figs. 5a and 5b, also Figs. 7a and 7b show that multi-stage amplifiers have higher cut-off frequency than the one-stage amplifier. At a given amplification rate, the output signals amplified with the multi-stage amplifiers preserve the original form of the input signal at a much higher degree.

4. Comparison of mechanisms of signal amplification in biological and electrical engineering systems

By comparing the results for signal amplification in biological cells and electrical circuits (Figs. 5 and 7) we see that cascades represent a unique mechanism in providing significant amplifications of input signals and enable very short turn-on and turn-off switching times which results in clear and reliable responses of the systems. In order to analyse these mechanisms of amplification even further and to compare their common characteristics also from the mathematical point of view, we need to construct the corresponding mathematical model for electrical signal amplification presented in Fig. 7. The mathematical model is constructed on the basis of the amplifier gain characteristic obtained in Fig. 7a. In order to describe the gain characteristic mathematically, we start with the well-known general description of the gain characteristic for one-stage operational amplifier [40]:

$$A_{u,1}(\omega) = \frac{A_{CL}}{1 + \frac{j\omega}{\omega_c}}. \quad (13)$$

where ω_c is the cut-off frequency for a rapid decrease in the $A_{u,1}(\omega)$, and A_{CL} is the closed-loop gain with feedback. The feedback path is determined by the resistances R_1 and R_2 (see Fig. 6), and the amplitude of the closed-loop gain, A_{CL} , can be expressed as:

$$A_{CL} = 1 + \frac{R_2}{R_1}. \quad (14)$$

The amplitude of the frequency-dependent gain $A_{u,1}(\omega)$ decreases rapidly at frequencies higher than ω_c , so that high amplification is limited to the frequencies within the bandwidth:

$$\omega_c = \left(1 + \frac{A_{OL}}{1 + R_2/R_1} \right) \omega_{OL}, \quad (15)$$

where ω_{OL} is the cut-off frequency of the open-loop gain A_{OL} , when the feedback path is open.

Taking into account specific characteristics for the operational amplifier TL082, $A_{OL} = 2 \cdot 10^5$ and $\omega_{OL} = 2\pi \cdot 20s^{-1}$ [50], Eqs. (13-15) represent the mathematical description of the results presented in Fig. 7a.

To be able to compare the amplification mechanisms in electrical engineering and biological systems, we transform Eqs. (13-15) from the frequency space into the time space. We apply the Laplacean transformation. In Eq. 13 the variable $j\omega$ is replaced by the Laplacean operator s , and by considering $A_{u,1} = U_1/U_0$, Eq. 13 is transformed into the following differential equation:

$$\frac{dU_1}{dt} = \omega_c A_{CL} U_0 - \omega_c U_1, \quad (16a)$$

which determines the time course of the output signal $U_1(t)$ in response to the given input signal $U_0(t)$. For the system of operational amplifiers as presented in Fig. 6, we then have:

$$\frac{dU_i}{dt} = \omega_c A_{CL} U_{i-1} - \omega_c U_i, \quad i = 1, 2, 3, \dots, n. \quad (16b)$$

Now we are able to compare directly the mathematical model for the electrical engineering amplifier, given by Eqs. (16a,b), and the mathematical model for the biological amplifier, given by Eqs. (1a,b). If the system of model Eqs. (1a,b) is linearized for $z_i \ll z_{tot}$, as usually considered in the modelling of protein kinase cascades [11, 28, 29], we obtain the following equations for the biological amplifier:

$$\frac{dz_1}{dt} = k_{off} \frac{z_{tot}}{K} x - k_{off} z_1, \quad (17a)$$

$$\frac{dz_i}{dt} = k_{off} \frac{z_{tot}}{K} z_{i-1} - k_{off} z_i. \quad i = 1, 2, 3, \dots, n. \quad (17b)$$

Equations (17a,b) are fully equivalent to Eqs. (16a,b), which mathematically confirms the observed analogy between the presented results for biological and electrical amplifiers. In particular, the maximal amplification z_{tot}/K is directly related to A_{CL} , and k_{off} to ω_c . As the cut-off frequency ω_c determines the boundary of low-pass filtering in electrical systems, the k_{off} plays equivalent role in the biological system.

5. Summary and Discussion

In this paper the analogy between signal amplification in biological and electrical engineering systems is presented. It is shown that basic mechanisms of multi-stage signal amplification by protein cascades in biological cells and operational amplifiers in

electrical engineering systems are mathematically identical. Both for biological and electrical amplifiers the cascades play the key role in assuring highly amplified output signals with short turn-on and turn-off times, preserving the form of signals, which attribute clear and reliable signalling in biological and electrical engineering systems. It is interesting that already three levels of cascades are very effective (see e.g. Figs. 5b and 7b). This is in accordance with some previous studies indicating that three cascade levels can be sufficient and effective enough for selective regulation of protein activation [37]. In biological cells three cascade levels could not only be the necessary minimal condition for effective functioning of protein cascades, but could also represent a physiological optimum, since indeed many protein cascades, e.g., MAPK cascade, usually consists of three levels [19].

According to the mathematical description of biological and electrical engineering amplifiers presented in this paper, the analogy between multi-step protein cascades and multi-stage operational amplifiers is well established. For example, with protein cascades high amplifications are obtained by reducing values of k_{off} at a given k_{on} (Eq. 11), and analogously, the multi-stage operational amplifiers provide large amplifications when R_1 is reduced at a given R_2 (Eq. 15). Eqs. (16) and (17) show that k_{off} in biological systems plays similar role as ω_c in operational amplifiers.

The analogy between the multi-step protein cascades and multi-stage operational amplifiers can also be well established by comparing both switching times. Similar to the expressions for switching times in biological amplifiers, t_{on} and t_{off} (Eq. (7) and Eq. (8), respectively), we can also calculate the switch-on, $t_{\text{on,e}}$, and switch-off, $t_{\text{off,e}}$, times for operational amplifiers:

$$t_{\text{on,e}} = \ln\left(\frac{1-\gamma_1}{1-\gamma_2}\right) \frac{1}{\omega_c}, \quad (19)$$

$$t_{\text{off,e}} = \ln\left(\frac{\gamma_2}{\gamma_1}\right) \frac{1}{\omega_c}. \quad (20)$$

Here again we see the analogous roles of k_{off} in protein cascades (Eqs. (7) and (8)) and that of the ω_c in operational amplifiers (Eqs. (19) and (20)).

It should be noted that the cascades considerably enlarge the ω_c in electrical and the k_{off} in biological systems, which reduces both the switch-on and switch-off time, and the output signal closely follow the input. The larger bandwidth of the signalling pathway (determined by larger ω_c) represents a higher information capacity of the pathway, i.e., much more information can be transmitted through the pathway per unit time [51]. Furthermore, the larger bandwidth of the signalling pathway, preserving the form of the output signals, also plays crucial role in cellular signalling where the signals are mainly frequency encoded, like it is the case for Ca^{2+} oscillations. There are experimental evidences that this might be of important physiological importance for regulation of several cellular processes like gene expression, for example [52, 53].

Figs. 5 and 7 show qualitatively equivalent responses of the studied biological and electrical amplifiers. This equivalency has also been mathematically confirmed by Eqs. (16) and (17). Both in biological and electrical engineering systems turn out that wiring of amplifiers into cascades enable larger signal amplifications and considerably contribute in preserving the form of the input signals. The analyses in the frequency space show that protein cascades and operational amplifiers both act as low-pass filters (Figs. 5 and 7). For protein cascades as well as for operational amplifiers the frequency spectrum is enlarged if the amplification rates of particular amplifiers in the cascade are smaller

(Figs. 5a and 7a). Although amplification rates of particular amplifiers in the cascade are smaller, a desired high amplification is achieved by the cascade since the amplification equals to the product of all particular amplifications of the ingredient partial amplifiers. At the same time, due to the higher permeability of the particular low-pass filters of the ingredient-amplifiers in the cascades, the multi-stage amplifier is also characterised by a higher permeability for higher frequencies (Figs. 5b and 7b). This higher permeability for the frequencies importantly contributes in preserving the initial form of input signals and hence enables high performance of cascade amplifiers in order to have high amplifications and keeping the form of the input signal at the same time.

It should be pointed out that the role of cascades in providing a common mechanism of signal amplification in biological and electrical engineering systems is of particular importance for efficient and reliable functioning of biological and electrical engineering systems. As they enable large amplifications of the input signals with extremely fast turn-on and turn-off characteristics, the protein cascades play crucial role in providing efficient and reliable cellular signalling. It is indeed impressive that these extremely efficient, evolutionary developed, biological mechanisms are mathematically fully equivalent with the man-developed technical systems, which indicates the successful way of technology development.

References

- 1 R. Alves and M.A. Savageau, Comparative analysis of prototype two-component systems with either bifunctional or monofunctional sensors: differences in molecular structure and physiological function, *Mol. Microbiol.* 48 (2003) 25-51.

- 2 L.E. Ulrich, E.V. Koonin and I.B. Zhulin, One-component systems dominate signal transduction in prokaryotes, *Trends Microbiol.* 13 (2005) 52-56.
- 3 H.M. Sauro and B.N. Kholodenko, Quantitative analysis of signaling networks, *Prog. Biophys. Mol. Biol.* 86 (2004) 5-43.
- 4 R.S. Neves and R. Iyengar, Modeling of signaling networks, *BioEssays* 24 (2002) 1110-1117.
- 5 D. Bray, Protein molecules as computational elements in living cells, *Nature* 376 (1995) 307-312.
- 6 G.A. Wray, Promoter logic, *Science* 279 (1998) 1871-1872.
- 7 M. Ptashne, *Genetic Switch: Phage Lambda and Higher Organisms* (Cell Press, Blackwell Scientific Publications, 2nd edn. 1992).
- 8 R.R. Reed, How does the nose know?, *Cell.* 60 (1990) 1-2.
- 9 L. Stryer, Visual excitation and recovery, *J. Biol. Chem.* 266 (1991), 10711-10714.
- 10 D.E. Koshland, Biochemistry of sensing and adaptation, *Trends Biochem. Sci.* 5 (1980), p. 297.
- 11 P.B. Detwiler, S. Ramanathan, A. Sengupta and B.I. Shraiman, Engineering aspects of enzymatic signal transduction: photoreceptors in the retina, *Biophys J.* 79 (2000) 2801-2817.
- 12 G. Wald, Visual excitation and blood clotting, *Science* 150 (1965) 1028-1030.
- 13 S.M. Levine, Enzyme amplifier kinetics, *Science* 152 (1966) 651-653.
- 14 J.E. Ferrell, Tripping the switch fantastic: how a protein kinase cascade can convert graded inputs into switch-like outputs, *Trends Biochem. Sci.* 21 (1996) 460-466.

- 15 G.C. Brown, J.B. Hoek and B.N. Kholodenko, Why do proteins have more than one level?, *Trends Biochem. Sci.* 22 (1997) p. 288.
- 16 G. Pearson, F. Robinson, T. Gibson, B.E. Xu, M. Karandikar, K. Berman and M. Cobb, Mitogen-activated protein (MAP) kinase pathways: Regulation and physiological functions, *Endocr Rev.* 22 (2001) 153-183.
- 17 E.R. Stadtman and P.B. Chock, Superiority of Interconvertible Enzyme Cascades in Metabolic Regulation: Analysis of Multicyclic Systems, *Proc. Natl. Acad. Sci. USA.* 74 (1977) 2766-2770.
- 18 D.E. Koshland, A. Goldbeter and J.B. Stock, Amplification and adaptation in regulatory and sensory systems, *Science* 217 (1982) 220-225.
- 19 C. Widmann, S. Gibson, M.B. Jarpe and G.L. Johnson, Mitogen-Activated Protein Kinase: Conservation of a Three-Kinase Module From Yeast to Human, *Physiol. Rev.* 79 (1999) 143-180.
- 20 P.B. Chock, S.G. Rhee and E.R. Stadtman, Interconvertible enzyme cascades in cellular regulation, *Annu. Rev. Biochem.* 49 (1980) 813-843.
- 21 A. Goldbeter and D.E. Koshland, An Amplified Sensitivity Arising from Covalent Modification in Biological Systems, *Proc. Natl. Acad. Sci. USA* 78 (1981) 6840-6844.
- 22 A. Goldbeter and D.E. Koshland, Sensitivity amplification in biochemical systems, *Q. Rev. Biophys.* 15 (1982) 555-591.
- 23 A. Goldbeter and D.E. Koshland, Ultrasensitivity in biochemical systems controlled by covalent modification. Interplay between zero-order and multisteps effects, *J. Biol. Chem.* 259 (1984) 14441-14447.

- 24 V.K. Mutalik, A.P. Singh, J.S Edwards and K.V. Venkatesh, Robust global sensitivity in multiple enzyme cascade system explains how the downstream cascade structure may remain unaffected by cross-talk, *FEBS Letters* 558 (2004) 79-84.
- 25 B.N. Kholodenko, J.B. Hoek, H.V. Westerhoff and G.C. Brown, Quantification of information transfer via cellular signal transduction pathways, *FEBS Letters* 414 (1997) 430-434.
- 26 R. Heinrich, B.G. Neel and T.A. Rapoport, Mathematical models of protein kinase signal transduction, *Mol. Cell.* 9 (2002) 957-970.
- 27 K. Mayawala, C.A. Gelmi and J.S. Edwards, MAPK cascade possesses decoupled controllability of signal amplification and duration, *Biophys J.* 87 (2004) L01-L03.
- 28 M. Chaves, E.D. Sontag and R.J. Dinerstein, Optimal length an signal amplification in weakly activated signal transduction cascades, *J. Phys. Chem. B* 108 (2004) 15311-15320.
- 29 J. Nakabayashi and A. Sasaki, Optimal phosphorylation step number of intracellular signal-transduction pathway, *J. theor. Biol.* 233 (2005) 413-421.
- 30 M. Marhl and V. Grubelnik, Role of cascades in converting oscillatory signals into stationary step-like responses, *Biosystems* 87 (2007) 58-67.
- 31 D.E. Koshland, A. Goldbeter and J.B. Stock, Amplification and Adaptation in Regulatory and Sensory Systems, *Science* 217 (1982) 220-225.
- 32 D. Fell, *Understanding the Control of Metabolism* (Portland Press, 1997).
- 33 S. Balaji and S. Lakshminarayanan, Conceptual comparision of metabolic pathways with electronic circuits, *Journal of Bionics Engineering* 1 (2004) 175-182.

- 34 K.H. Chiam, V. Bhargava, G. Rajagopal, Oscillatory dynamics in the mitogen-activated protein kinase cascade, Computational Systems Bioinformatics Conference, Stanford, California (2005) 164-165.
- 35 P. Hersen, M.N. Mclean, L. Mahadevan and S. Ramanathan, Signal processing by HOG MAP kinase pathway, PNAS 105 (2008) 7165-7170.
- 36 A.P. Arkin, in: Signal processing by biochemical reaction networks, ed. J. Walleczek, Self-Organized Biodynamics and Nonlinear Control (Cambridge University Press, 2000) 112-144.
- 37 M. Marhl, M. Perc and S. Schuster, Selective regulation of cellular processes via protein cascades acting as band-pass filters for time-limited oscillations, FEBS Lett. 579 (2005) 5461-5465.
- 38 J.E. Ferrell, Tripping the switch fantastic: how a protein kinase cascade can convert graded inputs into switch-like outputs, Trends Biochem. Sci. 21 (1996) 460-466.
- 39 J.R. Ragazzini, R.H. Randall, F.A. Russell, Alysis of Problems in Dynamics by Electronic Circuits, Proceedings of the IRE 35 (1947) 444-452.
- 40 F.B. Theodore, S.B. Jeffrey and R. Guillermo, Electronic Devices and Circuits, (Prentice Hall, 6th edn., 2004).
- 41 C. Juang, S.F. Shiue, S.Y. Tsai and J.N. Yang, Transimpedance amplifiers using three cascade variable inverter gain stages, Analog Integr Circ Sig Process 49 (2006) 299-302.
- 42 A. Maxim, A 10.7GHz SiGe BICMOS limiting amplifier using multiple offset cancellation loops, Custom Integrated Circuits Conference, Proceedings of the IEEE (2005) 127-130.

- 43 S. Trotta, H. Knapp, K. Aufinger, T.F. Meister, J. Bock, B. Dehlink and W. Simburger, A.L. Scholtz, An 84 GHz Bandwidth and 20 dB Gain Broadband Amplifier in SiGe Bipolar Technology, *IEEE Solid-State Circuits Society* 42 (2007) 2099-2106.
- 44 N.M. Woods, K.S.R. Cuthbertson and P.H. Cobbold, Repetitive transient rises in cytoplasmic free calcium in hormone-stimulated hepatocytes, *Nature* 319 (1986) 600-602.
- 45 M. Falcke, Reading the patterns in living cells - the physics of Ca^{2+} signaling, *Adv. Phys.* 53 (2004) 255-440.
- 46 S. Matsuda, H. Kosako, K. Takenaka, K. Moriyama, H. Sakai, T. Akiyama, Y. Gotoh and E. Nishida, Xenopus MAP kinase activator: identification and function as a key intermediate in the phosphorylation cascade, *EMBO J.* 3 (1992) 973-982.
- 47 N. Yew, M.L. Mellini and G.F. Vande Woude, Meiotic initiation by the mos protein in Xenopus, *Nature* 355 (1992) 649-652.
- 48 O. Haccard, B. Sarcevic, A. Lewellyn, R.S. Hartley, L.M. Roy, T. Izumi, E. Erikson and J.L. Maller, Induction of metaphase arrest in cleaving Xenopus embryos by MAP kinase, *Science* 262 (1993) 1262-1265.
- 49 J. Adams, *Mastering Electronics Workbench* (McGraw-Hill, 1st edn. 2001).
- 50 National Semiconductor Corporation, <http://cache.national.com/ds/TL/TL082.pdf>, accessed April 2007.
- 51 C.E. Shannon, A mathematical theory of communication, *Bell. Syst.Tech. J.* 27 (1948) 379-423 and 623-656.

- 52 R.E. Dolmetsch., K. Xu and R.S. Lewis, Calcium oscillations increase the efficiency and specificity of gene expression, *Nature* 392 (1998) 933-936.
- 53 W. Li, J. Llopis, M. Whitney, G. Zlokarnik and R.Y. Tsien, Cell-permeant caged InsP(3) ester shows that Ca^{2+} spike frequency can optimize gene expression, *Nature* 392 (1998) 936-1941.

ACCEPTED MANUSCRIPT

Figure Captions

Figure 1: Schematic presentation of the protein cascade.

Figure 2 Signal amplification $A_{1,ss}$ in dependence on the dissociation constant K . Parameter values: $x_{\max} = 1\mu\text{M}$ and $z_{\text{tot}} = 100\mu\text{M}$. The dash-dotted line represents the lower boundary of signal amplification, *i.e.*, $A_{1,ss} = 1$.

Figure 3 Amplified signals for three different values of k_{off} . The value of k_{on} is constant, $k_{\text{on}} = 1\mu\text{M}^{-1}\text{s}^{-1}$.

Figure 4 (a) Signal amplification, $A_{i,ss}$, for $i = 1, 2, \dots, 5$, in dependence on the dissociation constant K . Parameter values: $x_{\max} = 1\mu\text{M}$, $z_{\text{tot}} = 100\mu\text{M}$. The limit $A_{n,ss \rightarrow \infty}$ is indicated by the dashed line. (b) Amplified signals obtained by i -step cascades, where $i = 1, 2, \dots, 5$, $k_{\text{on}} = 1\mu\text{M}^{-1}\text{s}^{-1}$, and $k_{\text{off}} = 10\text{s}^{-1}$.

Figure 5 (a) Frequency characteristics of the 1-step amplifier for the same parameter values as taken in Fig. 3. (b) Frequency characteristics of the i -step cascade amplifier; solid line: 1-step cascade amplifier, $k_{\text{off}} = 1\text{s}^{-1}$; dashed line: 2-step cascade amplifier, $k_{\text{off}} = 9.51\text{s}^{-1}$; dotted line: 3-step cascade amplifier, $k_{\text{off}} = 19.7\text{s}^{-1}$.

Figure 6 Three non-inverting operational amplifier stages connected into a cascade.

Figure 7 Results of signal amplification for operational amplifier TL082. (a) Frequency characteristics of the one-stage amplifier for $R_1 = 1\text{k}\Omega$. (b) Frequency characteristics of the i -stage amplifier. Solid line: 1-stage amplifier, $R_2 = 99\text{k}\Omega$; dashed line: 2-stage amplifier, $R_2 = 9\text{k}\Omega$; dotted line: 3-stage amplifier, $R_2 = 3.64\text{k}\Omega$; in all cases $R_1 = 1\text{k}\Omega$.

Figures

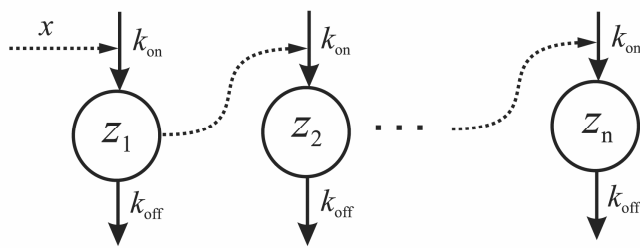

Figure 1

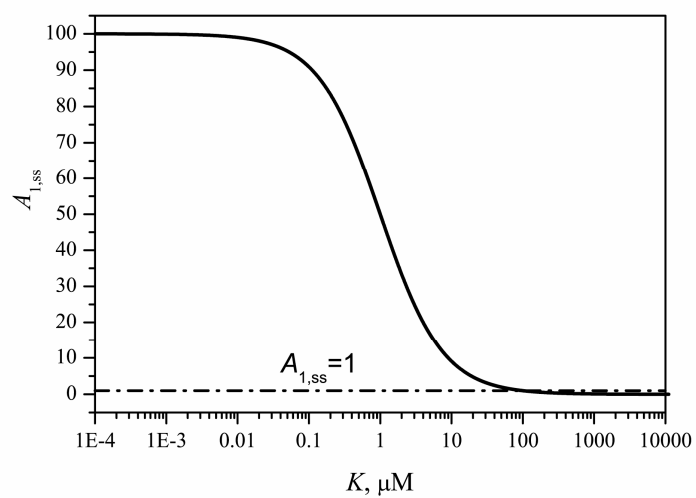

Figure 2

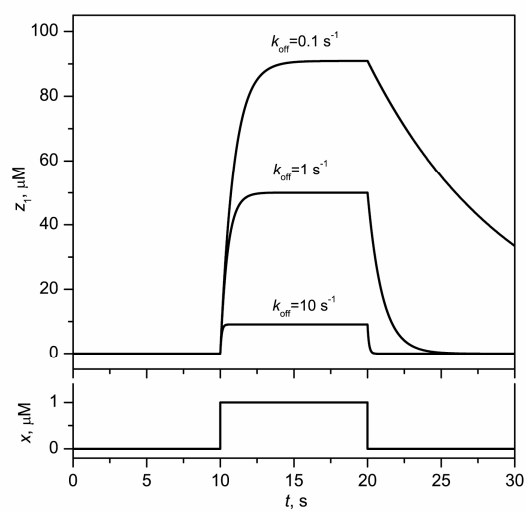

Figure 3

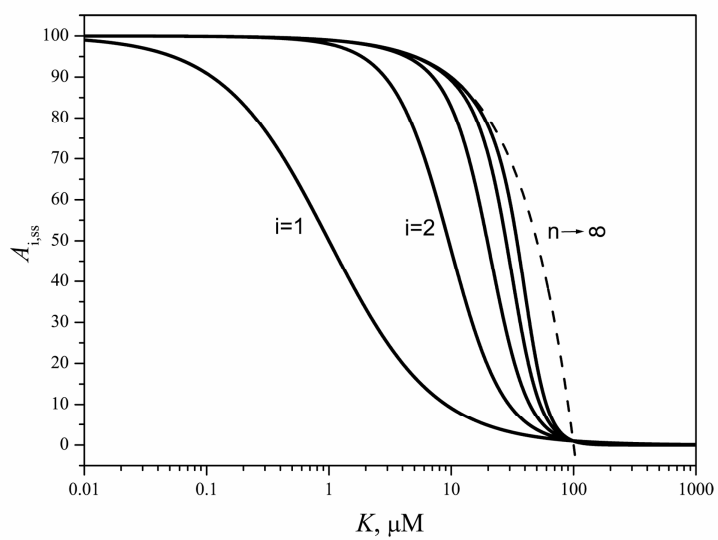

Figure 4a

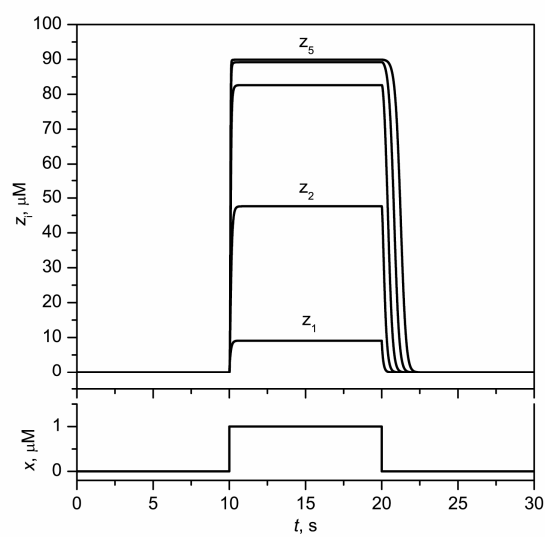

Figure 4b

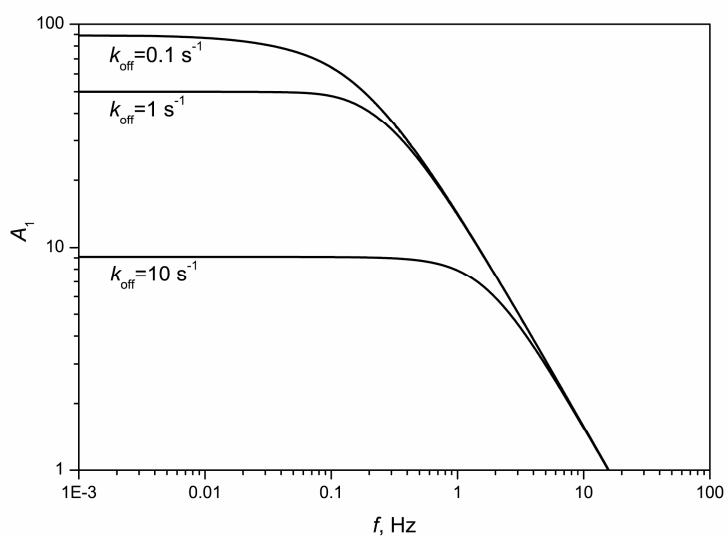

Figure 5a

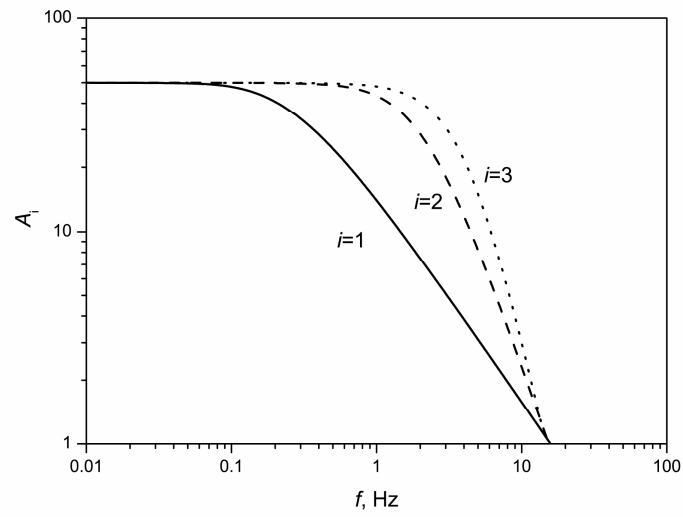

Figure 5b

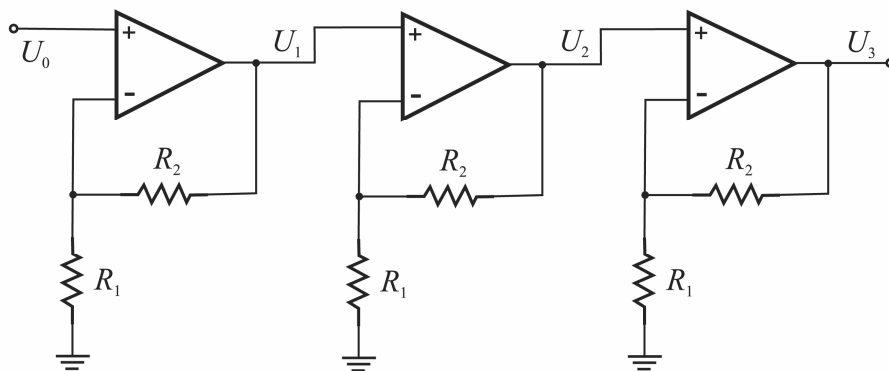

Figure 6

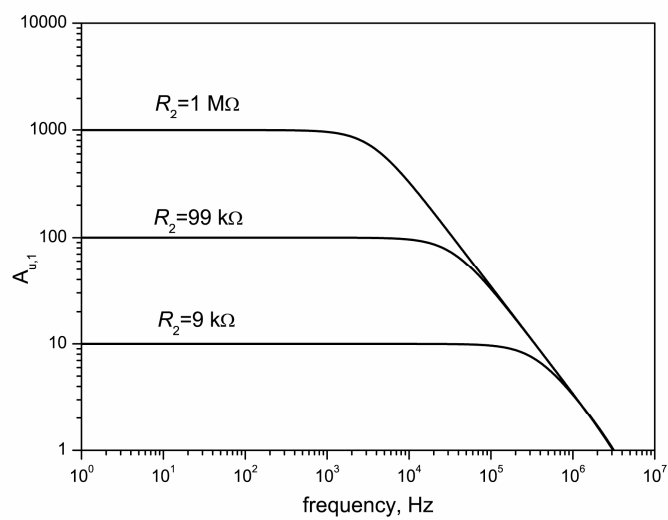

Figure 7a

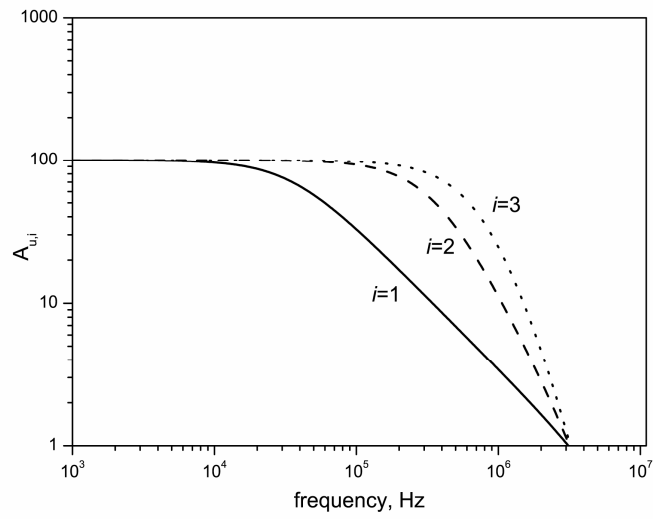

Figure 7b