



HAL
open science

A synthesis approach for reproducing the response of aircraft panels to turbulent boundary layer excitations

Cédric Maury, Teresa Bravo

► **To cite this version:**

Cédric Maury, Teresa Bravo. A synthesis approach for reproducing the response of aircraft panels to turbulent boundary layer excitations. 10ème Congrès Français d'Acoustique, Apr 2010, Lyon, France. hal-00539768

HAL Id: hal-00539768

<https://hal.science/hal-00539768>

Submitted on 25 Nov 2010

HAL is a multi-disciplinary open access archive for the deposit and dissemination of scientific research documents, whether they are published or not. The documents may come from teaching and research institutions in France or abroad, or from public or private research centers.

L'archive ouverte pluridisciplinaire **HAL**, est destinée au dépôt et à la diffusion de documents scientifiques de niveau recherche, publiés ou non, émanant des établissements d'enseignement et de recherche français ou étrangers, des laboratoires publics ou privés.

A Synthesis Approach for Reproducing the Response of Aircraft Panels to Turbulent Boundary Layer Excitations

Cédric Maury¹, Teresa Bravo²

¹Laboratoire de Mécanique et d'Acoustique (LMA), 31, chemin Joseph Aiguier, 13402 Marseille Cedex 20, maury@lma.cnrs-mrs.fr

²Instituto de Acustica – CSIC (Consejo Superior de Investigaciones Científicas), Serrano 144, 28006 Madrid, Spain, teresa.bravo@ia.cetef.csic.es

Random wall-pressure fluctuations due to a Turbulent-Boundary Layer (TBL) are a feature of the air flow over an aircraft fuselage under cruise conditions, creating undesirable effects such as cabin noise annoyance. In order to test potential solutions for the reduction of TBL-induced noise, a cost-efficient alternative to in-flight measurements or wind-tunnel testing involves simulating the response of aircraft structures to TBL excitation in the laboratory. The authors have already shown that the TBL simulation using a near-field array of loudspeakers is limited to the very low frequency range due to the rapid decay of the spanwise correlation length as frequency increases. The present study addresses the problem of directly simulating the vibroacoustic response of an aircraft skin panel using a near-field array of suitably driven loudspeakers. It is compared with the use of an array of shakers and piezoelectric actuators. It is shown how the wavenumber filtering capabilities of the panel reduces the number of sources required, thus dramatically enlarging the frequency range over which the TBL vibro-acoustic response is reproduced with accuracy. Direct reconstruction of the TBL-induced panel response is found to be feasible over the hydrodynamic coincidence frequency range using a limited number of actuators driven by optimal signals. It is shown that piezoelectric actuators, which have more practical implementation than shakers, provide a more effective reproduction of the TBL response than near-field loudspeakers.

1 Introduction

In the aeronautical industries, the determination of the response of structures to TBL wall-pressure fluctuations is a subject of great interest in order to assess the efficiency of potential solutions to reduce this source of noise, which is often the most significant in aircraft cabin during cruise conditions. In-flight measurements and experiments in anechoic wind tunnels are usually carried out to characterise the TBL-induced noise [1, 2]. Due to the complexity and cost of these methods, scientists are more and more concerned about the design of cost-efficient test facilities that could directly simulate the characteristics or the effect of TBL wall-pressure fluctuations.

A simulation study by Robert and Sabot assessed the use of a limited number of point force actuators in order to reproduce the vibrating response of a panel excited by a hydrodynamic TBL [3]. They observed that an array of 5 suitably driven actuators were sufficient in principle to reproduce the resonant response of a low speed TBL-excited panel up to 1 kHz with an error less than 1 dB. More recently, a point array forcing experiment has been designed for reproducing the noise due to a high speed TBL and transmitted through aircraft sidewalls [4]. This technique was able to simulate resonant forcing such as “rain on the roof” excitation, but it did not work for other types of random pressure fields that induce a non-resonant forcing of the panel such as a TBL or an acoustic diffuse field.

Non-resonant excitations could be generated using an array of acoustic sources. They would produce acoustic waves impinging on the test panel with a range of trace velocities, thus being able to synthesize decaying correlation functions such as the one due to a TBL. Maury *et al.* have presented a simulation study that assumes an

array of near-field loudspeakers driven by optimal signals in order to generate a random pressure field able to reproduce the statistics of TBL wall-pressure fluctuations [5]. The target pressure field was specified in terms of the Cross-Spectral Density (CSD) matrix between the outputs of an array of sensors when subject to a TBL excitation. It was observed that, due to the exponential decay of the correlation area with frequency, it would be limited to the very low frequency range given a reduced set of loudspeakers.

By means of the exact proper orthogonal decomposition of the random process associated to a TBL, a theoretical lower bound has been established on the number of uncorrelated components required for an accurate approximation of a TBL pressure field, at least 2.1 sources per unit spanwise correlation length [6, 7]. The authors have further investigated the practical feasibility of simulating spatially correlated random pressure fields with prescribed spectral density. An experimental set-up has been designed for the synthesis of an acoustic diffuse field, a grazing incident plane wave and a TBL using a near-field array of 4×4 loudspeakers driven by an Arbitrary Waveform Generator [7]. The optimum drive signals were determined from knowledge of the spatial correlation characteristics to be reproduced and prior identification of the acoustic transfer functions between the loudspeakers and an array of 13×16 microphones close to the simulation surface. The array of loudspeakers was situated inside a semi-anechoic chamber to assess the physical limitation of the synthesis technique. The methodology has shown to be successful for the laboratory simulation of an acoustic diffuse field and a grazing incident plane wave, up to 1 kHz and 650 Hz, respectively. However, for the TBL reproduction, the synthesis technique has shown acceptable accuracy only up

to about 200 Hz. A greater and denser number of loudspeakers could enlarge the upper frequency limit, but for a typical aircraft skin panel, this would require small-sized loudspeakers with necessarily reduced performances in the low frequency range.

The present study proposes an alternative methodology based on the direct synthesis of the TBL-induced panel response. Section 2 presents the framework for synthesizing the TBL or the velocity response of a panel subject to a TBL together with the determination of the optimum drive signals to an array of actuators. Computer simulation results are discussed in Section 3 when reproducing the TBL or the TBL-induced response using a near-field array of loudspeakers or structural actuators. The performance of the different strategies are then compared for a given number of actuators. Section 4 provides recommendations concerning the implementation of such strategies.

2 Theoretical framework

The general synthesis method for the reproduction of random forcing pressure fields with given spatial correlation characteristics has already been described in detail [5, 6, 7] and is summarized here. We consider a near-field array of loudspeakers, driven with signals optimised for the simulation of the desired random field. It can be the TBL wall-pressure fluctuations, \mathbf{d} , to be reproduced over a grid of regularly spaced microphones located in the proximity to the panel surface, as shown in Figure 1. One can also reproduced the velocity response, \mathbf{v} , induced by a given TBL pressure field, \mathbf{d} .

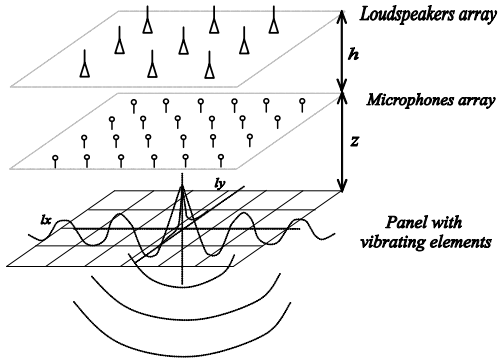

Figure 1: Sketch of the loudspeaker array synthesis experiment

A matrix of control filters, \mathbf{W} , is determined that generates the optimum input signals to the array of loudspeakers, which drive the microphone outputs \mathbf{y} (resp. the outputs of velocity sensors, \mathbf{y}_v), via the plant transfer matrices \mathbf{G} (resp. \mathbf{G}_v), to be statistically equivalent to the target pressure field \mathbf{d} (resp. \mathbf{v}). The vectors of error signals between the desired and generated pressure (resp. velocity) output signals are defined to be, respectively

$$\mathbf{e} = \mathbf{d} - \mathbf{y} = (\mathbf{D} - \mathbf{G}\mathbf{W})\mathbf{x}, \quad (1)$$

$$\mathbf{e}_v = \mathbf{v} - \mathbf{y}_v = \mathbf{G}_v(\mathbf{D} - \mathbf{G}\mathbf{W})\mathbf{x}, \quad (2)$$

as illustrated in Figure 2 with \mathbf{x} , a set of uncorrelated white noise reference signals and \mathbf{D} , a matrix of shaping filters, calculated from Equation (3) using an eigen-decomposition of the CSD matrix \mathbf{S}_{dd} .

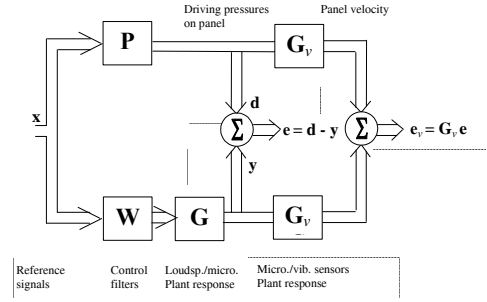

Figure 2: Block diagram for the calculation of the least-squares control filters to reproduce the TBL pressures or the TBL-induced velocities over the panel surface

The \mathbf{S}_{dd} matrix is taken from the Corcos model which is particularly well suited to describe the statistics of TBL wall-pressure fluctuations induced by high-speed subsonic flows [8]:

$$S_{dd}(\mathbf{r}; \omega) = S_0(\omega) e^{-|r_x|/L_x} e^{-|r_y|/L_y} e^{-j\omega r_y/U_c}, \quad (3)$$

where U_c is the flow convection velocity, L_x and L_y are the correlation lengths along the spanwise (or x -direction) and streamwise (or y -direction) respectively. They are assumed to be inversely proportional to frequency, and have the form

$$L_x = \frac{\alpha_x U_c}{\omega}, \quad L_y = \frac{\alpha_y U_c}{\omega} \quad (4)$$

where α_x and α_y are empirical constants taken to be respectively 1.2 and 8.

The cost functions being minimized are the sum of the Mean-Square Error (MSE) signals, $E[\mathbf{e}^H \mathbf{e}]$ (resp. $E[\mathbf{e}_v^H \mathbf{e}_v]$), normalized by the sum of the corresponding mean-square sensor outputs, $E[\mathbf{d}^H \mathbf{d}]$ (resp. $E[\mathbf{v}^H \mathbf{v}]$). This is achieved for optimum least-squares matrices of control filters, which reduce to

$$\mathbf{W}_{\text{opt},d} = \mathbf{G}^\dagger \mathbf{D}, \quad (5)$$

$$\mathbf{W}_{\text{opt},v} = (\mathbf{G}_v \mathbf{G})^\dagger \mathbf{G}_v \mathbf{D}, \quad (6)$$

where \mathbf{G}^\dagger denotes the pseudo-inverse of \mathbf{G} .

We note that synthesis of the TBL simulation with acoustic sources requires knowledge of the transfer function matrix \mathbf{G} between all pairs of loudspeakers and microphones, and the matrix of shaping filters, \mathbf{D} , calculated from \mathbf{S}_{dd} . Simulating the TBL-induced velocity response requires knowledge of $\mathbf{G}_v \mathbf{G}$, the transfer function matrix measured between all pairs of loudspeakers and velocity sensors, of \mathbf{D} , the target filter matrix, and of

\mathbf{G}_v , the transfer mobility matrix, associated to the panel velocity response due to a unit point force excitation. This latter quantity can be determined from modal analysis of the panel vibrations and/or modelled as series of the panel normal modes.

In this context, the use of structural actuators such as miniature shakers or piezoelectric patches has also been investigated. The shakers exert normal forces over the rod-panel contact surfaces, and so can be used to simulate both TBL forcing pressures at these discrete positions, but also the TBL-induced velocity response. In this case, \mathbf{G} in Equations (5-6) is the plant matrix between all pairs of input drive signals to the shakers and the applied normal forces measured by the shakers impedance heads. It is a diagonal gain matrix which might also account for off-diagonal cross-coupling effects through the shakers inertial back-reaction to the panel vibrations.

The piezoelectric rectangular elements are distributed actuators symmetrically bonded on either side of the panel surface and activated 180° out-of-phase, so that they cause uniform bending moments along their edges over the panel surface [9]. Therefore, they cannot be used in order to simulate wall-pressure fluctuations. However, they are suitable candidates to reproduce the vibrating response of a panel to a TBL excitation, as shown in the next section.

3 TBL simulation results

3.1 Synthesis with an array of loudspeakers

A series of computer simulations has been performed using a uniform planar array of 3×4 loudspeakers, driven to reproduce either the TBL statistics over a grid of 13×17 microphones evenly distributed over the panel surface, or the TBL-induced velocity response over 13×17 velocity sensor positions. The ratio between the number of sources as well as the number of sensors along each direction of the panel is constant and is chosen equal to the panel aspect ratio, $l_y/l_x \approx 1.3$, with the panel parameters given in Table 1. The loudspeakers are positioned as far from the microphone array as the distance they are apart from each other, i.e. with a separation distance of about 0.15 m, in order to lower the plant matrix condition number [5, 6].

Parameter	Value
Free-stream velocity	$U_\infty = 115 \text{ ms}^{-1}$
Dimensions	$l_x = 0.314 \text{ m}, l_y = 0.414 \text{ m}$
Thickness	$h_p = 0.001 \text{ m}$
Mass density	$\rho_p = 2700 \text{ kg m}^{-3}$
Young's modulus	$E_p = 7 \times 10^{10} \text{ Pa}$
Poisson ratio	$\nu = 0.33$
Damping ratio	$\eta = 0.02$

Table 1 : airflow and panel parameters

One simulates the statistics of a high-speed subsonic TBL with free-stream velocity $U_\infty = 115 \text{ ms}^{-1}$ up to 3 kHz, i.e. over a broad frequency range covering the whole

hydrodynamic coincidence frequency range, that extends up to 865 Hz in this configuration.

Figure 3 shows the panel kinetic energy due to an ideal TBL and when reproducing a number of target random fields, i.e. either the TBL or the TBL-induced velocity response. From the theoretical criterion of 2.1 acoustic sources per unit spanwise correlation length for the TBL simulation [6, 7], an array of 3×4 loudspeakers is only able to simulate the statistics of the TBL wall-pressure fluctuations up to 95 Hz (resp. 329 Hz) along the panel x - (resp. y -) directions. This trend can be verified through the dotted curve in Figure 2, which starts to significantly deviate from the grey reference curve above about 300 Hz. Unlike the TBL simulation, direct reproduction of the panel velocity response (dash-dotted curve) can be achieved with an acceptable accuracy up to 1.5 kHz. The MSE between the target and reproduced velocity, which quantifies the accuracy of the simulation, stays below -5 dB up to 1.5 kHz. It reaches the greatest reductions at the panel resonance frequencies at which the panel velocity response exhibits the largest spatial coherence. At these frequencies, the plant response $\mathbf{G}_v \mathbf{G}$ is well equalized by the control filters (Equation 6).

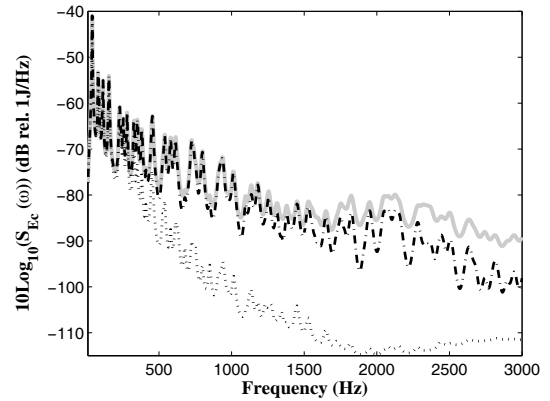

Figure 3 : Panel kinetic energy due to a TBL (grey) and the one generated using a near-field array of 3×4 loudspeakers driven to reproduce the TBL (dotted) or the TBL-induced velocity response (dash-dotted)

The accuracy in the spatial reproduction of the corresponding correlation structures is further examined when plotting in Figures 4, 5 and 6 the spatial correlation functions of the approximate CSDs, calculated with respect to a sensor at the centerpoint of the simulation surface, for the driving pressures acting on the panel (left column) and for the velocity response induced on the panel (right column). The top row shows the correlation functions due to the ideal Corcos TBL model (Equation (3)), the mid row the one due to the least-squares approximation to the TBL pressure field (Equation (5)), and the bottom row the one due to the least-squares approximation to the TBL-induced velocity field (Equation (6)). Values are given of the spatial errors, $\epsilon_{\alpha,\beta}$, between the ideal and approximate correlation functions associated to the field α when reproducing the field β .

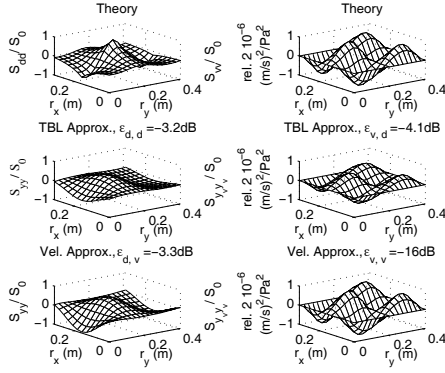

Figure 4: Spatial correlation structures at 275 Hz for the excitation (left) and the panel velocity response (right) due to a TBL (top) and when the TBL (middle) or the velocity are reproduced (bottom) using 3×4 loudspeakers.

CSDs are plotted in Figures 4 and 5, respectively at 275 Hz and 634 Hz, for which the modes (3,2) and (5,1) respectively are highly excited by the TBL when they are resonant. These frequencies fall within the hydrodynamic coincidence frequency range. At 275 Hz, in accordance with the above theoretical criterion, a near-field array of 3×4 loudspeakers is sufficient to reproduce the TBL correlation function (Fig. 4, mid left). Even though the TBL peak value is underestimated, the approximate induced velocity response is already well reproduced (Fig. 4, mid right), as it requires a fewer number of sources for its reproduction, due to a correlation area larger than the TBL at this frequency. At 634 Hz, the accuracy in both the approximate TBL and induced velocity degrades (Fig. 5, mid row), due to an insufficient number of sources per unit correlation length in either case.

In accordance with Figure 3, it can be seen that direct simulation of the TBL induced velocity response at these frequencies provides accurate results on the least-squares approximation to the panel velocity, with significant reductions of the spatial errors of about 16 dB and 5 dB, at 275 Hz and 634 Hz respectively (Figs. 4 and 5, bottom right). We note that simulating the velocity response at 275 Hz induces a beneficial backward effect on the approximate TBL (Fig. 4, bottom left), which is generated with about the same accuracy than the target one (Fig. 4, mid left).

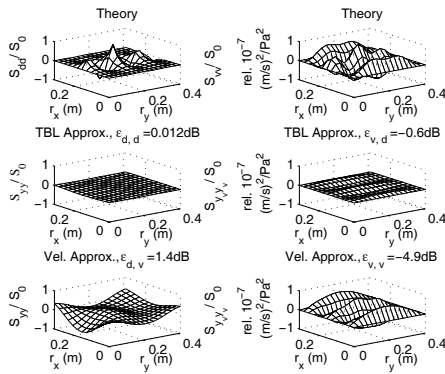

Figure 5: Spatial correlation structures at 634 Hz for the excitation (left) and the panel velocity response (right) due to a TBL (top) and when the TBL (middle) or the velocity are reproduced (bottom) using 3×4 loudspeakers.

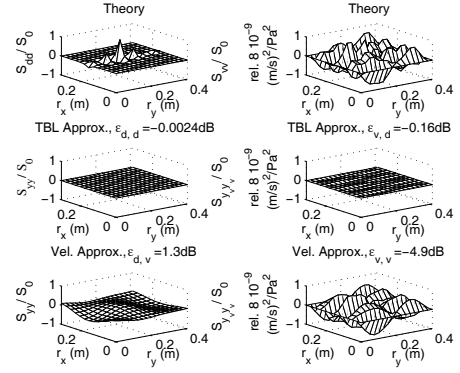

Figure 6: Spatial correlation structures at 1273 Hz for the excitation (left) and the panel velocity response (right) due to a TBL (top) and when the TBL (middle) or the velocity are reproduced (bottom) using 3×4 loudspeakers.

CSDs are plotted in Figure 6 at 1273 Hz that falls above the hydrodynamic coincidence frequency range and for which the mode (7,2) is resonant and weakly excited, but couples through the TBL with low-order modes which are non resonant, but highly excited. Clearly, simulating the TBL with 3×4 loudspeakers provides very inaccurate results (Fig. 6, mid row) as the panel width comprises 19 spanwise correlation lengths at this frequency. The theoretical criterion then predicts that an array of 40×52 acoustic sources would be required for an accurate TBL simulation, which is an unrealistically large amount of sources. However, a very reduced set of 3×4 loudspeakers is still able to generate with enough accuracy an approximate TBL-induced velocity response (Fig. 6, bottom right).

3.2 Synthesis with acoustic or structural actuators

It would be of great interest to compare the simulation performance between loudspeakers, piezoelectric elements and point force actuators. Figure 7 shows the panel kinetic energy due to an ideal TBL and when using a uniform array of 3×4 loudspeakers, shakers or PZT rectangular patches driven to reproduce the TBL-induced panel velocity response.

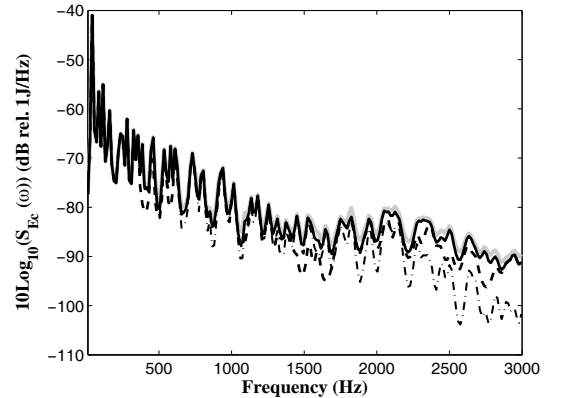

Figure 7: Panel kinetic energy due to a TBL (grey) and the one generated using an array of 3×4 actuators (loudspeakers: dash-dotted; shakers: dashed; PZTs: solid)

It can be seen from Figure 7 that the frequency range for simulating the TBL-induced velocity response is

significantly larger when using structural actuators (up to 3 kHz) with respect to acoustic sources (up to 1.5 kHz), the most accurate results being obtained when using PZT patches. This trend occurs especially when the panel resonant contribution becomes more and more dominant with respect to the non-resonant contribution, as it is the case when the frequency increases, the difference being due to the nature of coupling between the efforts exerted by the actuators and the panel modes being excited.

It is observed in Figure 7 (dashed curve) that the use of a uniform array of shakers is inefficient at simulating the velocity response at the resonant frequencies of the panel modes which have nodal lines at the shakers rod locations, and therefore do not couple with the point force actuators. When using PZT patches, there is still an effective moment around the nodal lines, so that the accuracy of the simulation is less selective than with an array of shakers, as clearly seen when comparing the dashed and solid curves in Figure 7.

4 Conclusions

A framework has been presented and computer simulation results have been discussed on the feasibility of simulating the velocity response induced by a high-speed TBL using a uniform array of acoustic or structural actuators. As already anticipated from the large error reduction induced on the panel response by a coarse simulation [5] or experimental synthesis [7] of the TBL excitation, a very reduced set of loudspeakers is able to simulate the panel velocity response over a broad frequency range, that extends beyond the hydrodynamic coincidence frequency. However, the use of distributed PZT patches shows large potential for reproducing the statistics of the TBL-induced response over a broader frequency range including a large proportion of resonant modes.

References

- [1] J. F. Wilby and F. L. Gloyne, "Vibration measurements of an airplane fuselage structure I. turbulent boundary layer excitation," *J. Sound Vib.* 23 (4), 443 - 466 (1972).
- [2] G. Robert, "Modélisation et simulation du champ exciteur induit sur une structure par une couche limite turbulente," Ph. D. Thesis No. 84-02, Ecole Centrale de Lyon, France, 1984.
- [3] Robert G., Sabot J., "Use of random forces to simulate the vibroacoustic response of a plate excited by a hydrodynamic turbulent boundary layer", *Proceedings of the ASME Winter Meeting: Symposium on Flow-Induced Vibrations*, 5, 53-61 (1984).
- [4] C. T. Hugin, A. P. Payne, D. C. Tomlinson, and K. H. Heron, "Simulation of turbulent boundary layer excitation by point array forcing experiment," Report on EU Framework V Project G4RD-CT-2000- 00223. Environmental Noise Associated with Turbulent Boundary Layer Excitation: ENABLE, QinetiQ Ltd, Farnborough, UK (2002).
- [5] C. Maury, S. J. Elliott, and P. Gardonio, "Turbulent boundary layer simulation with an array of loudspeakers," *AIAA J.* 42, 706–713 (2004).
- [6] T. Bravo and C. Maury, "The experimental synthesis of random pressure fields: Methodology," *J. Acoust. Soc. Am.* 120 (5), 2702–2711 (2006).
- [7] C. Maury and T. Bravo, "The experimental synthesis of random pressure fields: Practical feasibility," *J. Acoust. Soc. Am.* 120 (5), 2712–2723 (2006).
- [8] G. M. Corcos, "Resolution of pressure in turbulence," *J. Acoust. Soc. Am.* 35, 192–199 (1963).
- [9] E. K. Dimitriadis, C. R. Fuller, and C. A. Rogers, "Piezoelectric actuators for distributed vibration excitation of thin plates", *ASME J. Vib. Acoust.* 113, 100-107 (1991).