



**HAL**  
open science

## Characterization of the Thermal Dependence of SAW Stress Sensitivity

Sébastien Alzuaga, Eric Michoulier, Jean Michel Friedt, Gilles Martin, Pierre Berthelot, Valérie Pétrini, Sylvain Ballandras

► **To cite this version:**

Sébastien Alzuaga, Eric Michoulier, Jean Michel Friedt, Gilles Martin, Pierre Berthelot, et al.. Characterization of the Thermal Dependence of SAW Stress Sensitivity. 10ème Congrès Français d'Acoustique, Apr 2010, Lyon, France. hal-00539765

**HAL Id: hal-00539765**

**<https://hal.science/hal-00539765v1>**

Submitted on 25 Nov 2010

**HAL** is a multi-disciplinary open access archive for the deposit and dissemination of scientific research documents, whether they are published or not. The documents may come from teaching and research institutions in France or abroad, or from public or private research centers.

L'archive ouverte pluridisciplinaire **HAL**, est destinée au dépôt et à la diffusion de documents scientifiques de niveau recherche, publiés ou non, émanant des établissements d'enseignement et de recherche français ou étrangers, des laboratoires publics ou privés.

# 10ème Congrès Français d'Acoustique

Lyon, 12-16 Avril 2010

## Characterization of the thermal dependence of SAW stress sensitivity

Sébastien Alzuaga<sup>1</sup>, Éric Michoulier, Jean Michel Friedt<sup>2</sup>, Gilles Martin<sup>1</sup>,  
Pierre Berthelot<sup>1</sup>, Valerie Petrini<sup>1</sup>, Sylvain Ballandras<sup>1,2</sup>

<sup>1</sup> FEMTO-ST, Département Temps Fréquence, 26 Chemin de l'Épitaphe, 25000 Besançon

<sup>2</sup> SENSEOR, Parc TEMIS, 25000 Besançon

Surface Acoustic Waves (SAW) sensors have received an increasing interest as they reveal capable to be interrogated wirelessly without on-board power supply. Their used as stress sensor allows for remarkable linearity and repeatability. SAW devices can particularly be implemented for in-plane-stress measurement, yielding temperature compensated highly sensitive and linear sensors specially when built on AT-cut quartz wafers. However, their stress sensitivity is affected by temperature and an accurate account of the thermal impact on their mechanical properties is required for designing and calibrating the sensors properly. In this paper, we propose an experimental set-up enabling one to reliably apply controlled stress conditions to quartz substrate on which SAW resonators have been built. Finally, experimental evidence of the cross relation between temperature and stress sensitivity of the resonance frequency is reported.

### 1 Introduction

Surface acoustic wave (SAW) devices are analogic passive components used for signal processing. Excitation and detection of SAW are massively based on piezoelectric effects and developed on single-crystal substrates. Although a lot of SAW applications concerns filter and resonators, their use as sensors is now well developed, particularly because they can be wirelessly interrogate without any on-board power-supply. SAW devices can particularly be implemented for in-plane-stress measurement, yielding temperature compensated highly sensitive and linear sensors specially when built on AT-cut quartz wafers. As thermo-elastic properties of this material are well known, a high level of stress measurement accuracy can be achieved and predictability of the observed effects yields reliable design conditions. Modeling tools allowing for such predictions mainly are based on a so-called perturbation theory [1] which associates a description of the unperturbed elastic wave propagation parameters together with the simulation of stress perturbations applied to the substrate (which requires numerical simulation based on finite element analysis for complicated device architectures) via equations of non linear elasticity. The validation of such models imposes a reliable experimental basis involving numerous crystal orientation for a given material, and particularly for an anisotropic material such as quartz. In this work, we have developed an experimental set-up enabling one to reliably apply controlled stress conditions to quartz substrate on which SAW resonators have been built operating near 434 MHz (ISM band). The test bench applies flexural efforts on AT quartz cuts plates using a 3-point bending approach, yielding in-plane stress principally lying along the propagation direction. The first part of the paper presents the analysis basis of the prob-

lem. The mechanical set-up then is presented as well as the two SAW test devices. Finally, first experimental evidence of the cross relation between temperature and stress sensitivity of the resonance frequency is reported. We conclude on future systematic experiment campaign to fully characterize and calibrate the thermal evolution of SAW sensor stress sensitivity.

### 2 Fundamental background

The influence of temperature on the surface wave stability principally is governed by the thermo-elastic effective properties [2] and hence by the substrate crystal orientation when free to expand in all space directions. Assuming now that the substrate is clamped, glued or more generally cannot freely expand, stress are generated in its bulk when thermal expansion occurs. The wave sensitivity to stress then can notably change from the one predicted by the standard isothermal model. Exploiting SAW resonators for temperature or stress sensing purposes requires a comprehensive understanding of the way the respective sensitivity are linked together. From a theoretical point of view, one can resume the frequency evolution versus stress and temperature as follows:

$$\frac{\omega - \omega_0}{\omega_0} = \frac{\Delta\omega}{\omega_0} = \frac{\iiint_{\Omega} \left( \frac{\partial u_i^0}{\partial a_j} \bar{H}_{ijkl} \frac{\partial u_i^0}{\partial a_k} \right) dV}{2\rho_0\omega_0^2 \iiint_{\Omega} u_m^{*0} u_m^0 dV} \quad (1)$$

where the upper-script 0 denotes unperturbed harmonic fields (displacement  $u_i$  with time dependence implicitly equal to  $e^{j\omega t}$  and values (angular frequency  $\omega$ , mass density  $\rho$ ), i.e. without any static deformation. This formulation can be used even for complex fields (\* holds for complex conjugation). The  $\bar{H}_{ijkl}$  tensor represents

the perturbation of the medium elastic properties via its linear and non linear coefficients, as detailed below

$$\begin{aligned} \bar{H}_{ijkl} = & \delta_{ik}\bar{T}_{jl} + C_{ijkluv}\bar{S}_{uv} + C_{pjkl}\frac{\partial\bar{u}_i}{\partial a_p} \\ & + C_{ijql}\frac{\partial\bar{u}_k}{\partial a_q} + \frac{d\bar{u}_k}{d\theta}(\theta - \theta_0) \end{aligned} \quad (2)$$

where  $C_{ijkluv}$  are the third order (non linear) elastic constants,  $\bar{u}_i$ ,  $\bar{S}_{ij}$  and  $\bar{T}_{ij}$  are the space-dependent quasi-static displacements, linear deformations and stresses respectively. These terms also can depend on the temperature  $\theta$  ( $\theta_0$  is the reference temperature), which then must be known at each point of the medium. The dependence of the fundamental elastic constants versus temperature must be taken into account carefully, according to Tiersten et Sinha's developments [3] via its first order derivatives versus temperature. The expression (2) of the perturbation tensor must be considered in the case where differential thermal stresses arise (for instance a compound substrate with at least two materials exhibiting different thermal expansion coefficient or a substrate impeded to freely expand). It then obviously appears that simpler expressions of this tensor derived when considering structures composed of only one material and submitted to slowly varying perturbation phenomena yielding the so-called SAW temperature and stress sensitivity coefficient are not valid any more. These basic equations explain the fundamental reason of the proposed work.

### 3 Experimental bench

We then have designed a setup allowing for applying stress on SAW substrates to characterize the above mentioned phenomenon and the cross relation between SAW stress and temperature sensitivity. To try and separate intricate effects arising when heating clamped devices, we have simplified the experimental bench to apply a well-controlled stress state (i.e. mainly in-plane stress along the propagation direction) applied using a 3-point setup to reduce at maximum differential thermoelastic stresses. The plate is 3 cm long and the tested device is the one located near the center. Figure 2 shows a scheme of the test bench and figure 1 shows an example of the test vehicle on which bending stress is applied. The most critical parts of the setup are the robustness of the slide to temperature (we are presently limited to 100°C max) and the fragility of the electrical bonding.

The device is designed to limit as much as possible any rotation that could occur when applying stress on the SAW device. The weighting was limited to maximum 650 g to remain far from the quartz elasticity limit (experimentally found near 250 MPa). Preliminary tests have shown the capability of the device to provide stress sensitivity measurements repeatably. The bench then can be tested in a climatic oven to demonstrate its functionality. Figure 3 a photo of the implemented set-up. It consists of a sliding track on which calibrated weights are deposited to bend the quartz plate. The force is applied on the back side of the substrate to prevent any problem related to connection. The location

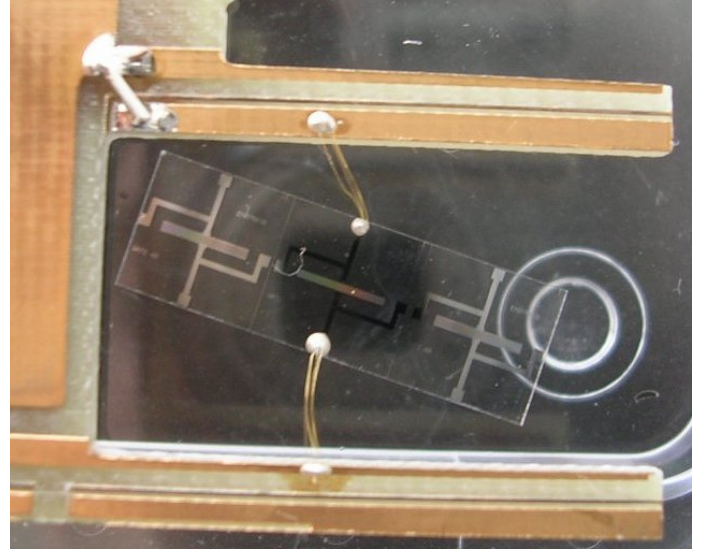

Figure 1: Quartz plate test vehicle for characterizing cross relation between SAW stress and thermal sensitivities.

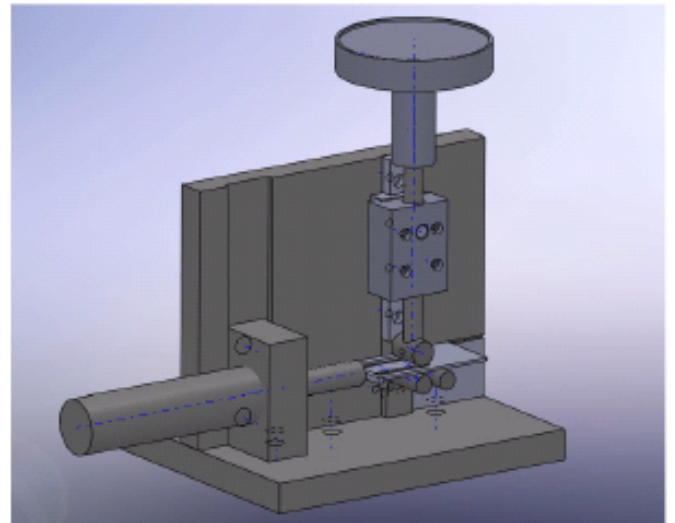

Figure 2: Scheme of the experimental bench.

of the plate can be accurately adjusted ( $4\mu\text{m}$  precision) to ensure reproducible experimental conditions.

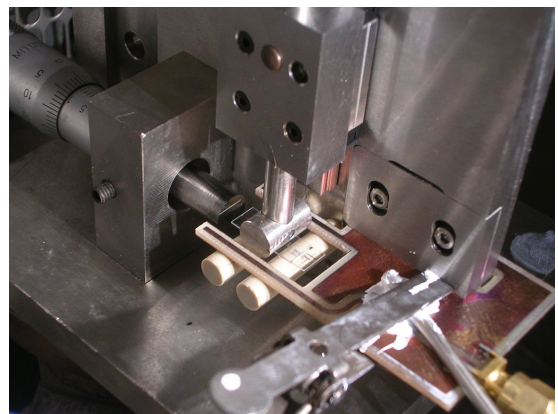

Figure 3: The temperature-stress characterization bench equipped with a SAW test vehicle.

## 4 Characterization results

Figure 4 shows a typical S-parameter response of the SAW resonator, centered near 434 MHz with a coupling coefficient of about 0.05% and a quality factor  $Q$  near 10000. This device was typically designed for wireless in-plane stress measurements. In-air interrogation distance typically ranges from 1 to 3 meters depending on the RF environment of the device.

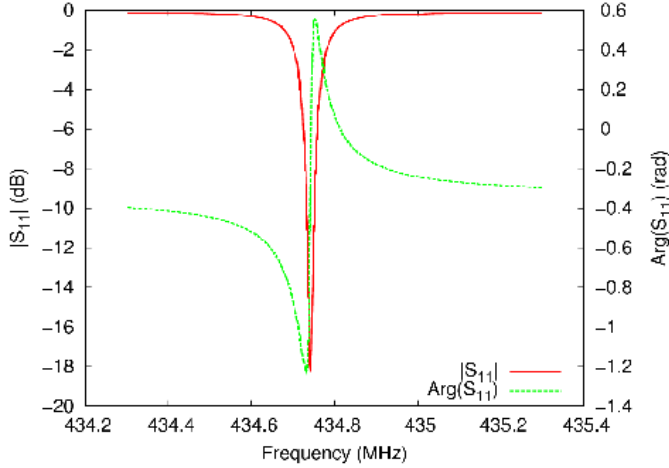

Figure 4: Typical S11 response of the SAW resonator of figure1 (coupling coefficient in the vicinity of 0.05%, quality factor near 10000).

The bench then has been placed in an oven allowing for programmed long term operation. The test consisted in loading the slide with different weights (from 260 g to 560g) and in recording the frequency shift versus temperature in the range 0-100°C. Figure 5 presents the absolute frequency shift of the device measured with temperature for different mass loading. It shows a diminution of the resonance frequency of the resonator with mass loading.

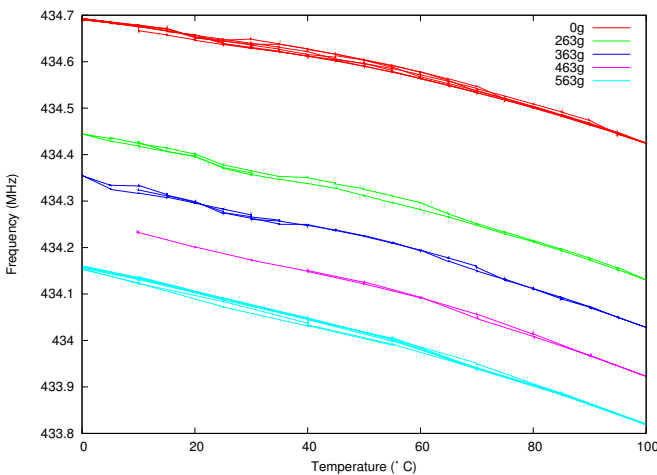

Figure 5: Absolute frequency shift with temperature for different mass loading.

In order to extract thermal dependance for each mass applied to the device, the measured frequency is fitted with a 2<sup>nd</sup> order polynomial  $f(T) = aT^2 + bT + c$  where  $c$  represents the frequency at 0°C.

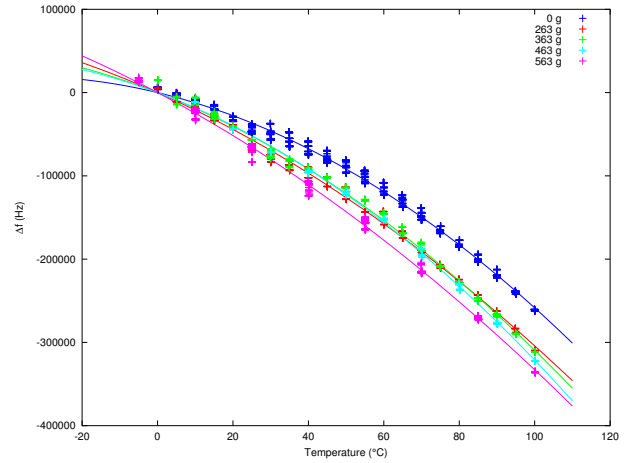

Figure 6: Relative frequency shift with temperature for different mass loading with the fitted polynomial.

When analysing the relative frequency shifts  $f - c$ , as shown on figure 6, we observe a slight change of the thermal drift slope from one mass to the other. The 0 g curve presents a different curvature but this can be explained by the different boundary condition of the resonator comparing to the mass loading condition. When no mass is applied, the device is in contact with 2 points whereas when a charge is applied, it is in contact at 3 points.

The main variation of thermal behaviour with stress comes from the uncertainty of the measure of frequency with temperature. Figure 7 shows the error on the temperature calculated from frequency measured with the polynomial coefficient from the fit. The error is about  $\pm 5^\circ\text{C}$ . This can explain the variation of the relative frequency shift with mass loading observed on figure 6.

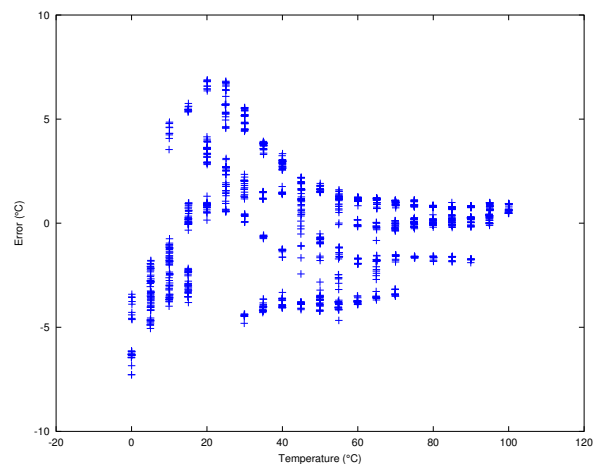

Figure 7: Error between calculated and measured temperature

If we pay attention of the effect of stress on the variation of frequency at 0°C, i.e. eliminating the temperature effect on the frequency, we observe a quiet good linearity of the frequency with mass loading (cf. figure 8). This shows that the experimental set-up proposes a

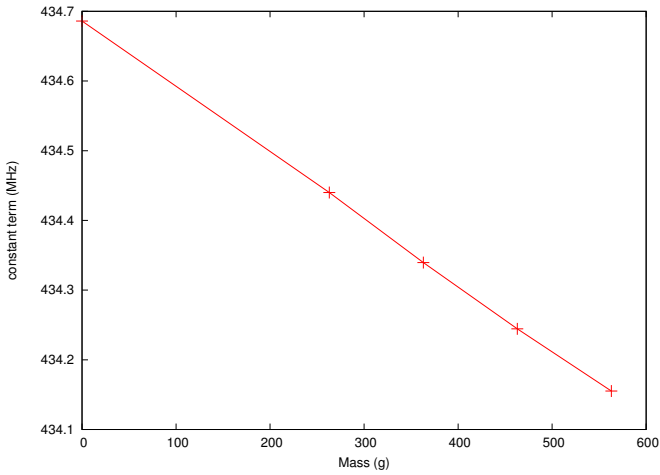

Figure 8: Evolution of frequency with mass loading at 0°C

good reliability of the stress applied on the quartz plate.

## 5 Conclusion

The characterization of cross relation between stress and temperature sensitivities of SAW devices must be achieved when developing temperature or stress sensors working on extended operational ranges (stress and temperature as well). We have proposed an experimental procedure to characterize such relation, consisting in applying well-controlled in plane stress in the propagation direction using a test bench based on bending effects and capable to operate in a climatic oven from room conditions up to 100°C. Experimental results show that for the uncertainty obtained on frequency measurements, differences induced by various stress conditions do not dramatically modify the thermal sensitivity of SAW resonators. The linear variation of the frequency shift induced by mass loading at 0°C allows to validate the proposed mechanical bench.

Future work will be achieved to first check the reciprocity between stress influence of temperature sensitivity and temperature influence of stress sensitivity. More experiments will be achieved to statistically confirm the first reported results. The setup will be used to characterize other materials and crystal cuts to find out SAW orientation minimizing the cross relation between stress and temperature sensitivities. Then different boundary conditions will be applied to the device to emphasize their effect to cross correlation between thermal and stress sensitivities.

## References

- [1] C. Baumhauer, H.F. Tiersten, *J. Acoust. Soc. Am.*, 54, 1017, (1973).
- [2] Sinha, B.K., Tiersten, H.F., “On the temperature dependence of the velocity of surface wave in quartz”, *J. Appl. Phys.*, Vol.51, n9, pp. 4659-4665, (1980)
- [3] Sinha, B.K., Tiersten, H.F., “On the temperature dependence of the velocity of surface wave in quartz”, *J. Appl. Phys.*, Vol.51, n9, pp. 4659-4665, (1980).